



Audio
CONNECTORS



Amphenol

ENTERTAINMENT INTERCONNECT CATALOGUE

Amphenol Australia Pty Ltd



Amphenol Australia Pty. Ltd.

Amphenol Australia's head office is based in Melbourne, Victoria and is the Sales, Marketing and Engineering centre of excellence for an extensive range of professional connector and cabling products. Satellite facilities of Amphenol Australia also exist in Colorado and Los Angeles, in the USA as well as Shenzhen, China.

Amphenol's global presence allows us to take full advantage of our numerous corporate resources and product portfolio to provide you with a vast offering and choice. Our extensive range is designed to meet the specific needs of the entertainment markets to make the selection of your interconnect partner an easy choice.

The Amphenol Audio international brand name was launched by Amphenol Australia in 2006 and represents the flag ship of one of the company's main core businesses and specialist product ranges. The company has been producing products for the pro-audio industry for over fifty years. Since the development of our XLR AC Series connectors, we have continued to provide our customers with exacting quality in an increasingly competitive environment.

Continuous improvement through ISO9001, a focus on environmental awareness and development of next generation industry leading products is our philosophy. As the entertainment industry moves into the future the emerging technologies from other industries has become more prevalent and more challenging. Amphenol Australia's global presence combined with its close technical relationships with other Amphenol sister divisions, each a specialist and leader in their own interconnect field, places it well to support innovation and meet this challenge head on.

The ability of Amphenol to provide a full range of design services required to support the customers applications design and modelling, applications engineering, fabrication, value-added assembly and testing, coupled with the largest interconnect offering on the market means that we can support all of your system level needs.

CONTENTS

	PAGE	
	AX SERIES XLR CABLE CONNECTORS	3
	METAL SHELL TYPE - SOLDER	4
	AC SERIES XLR CABLE CONNECTORS	10
	METAL SHELL TYPE - SOLDER	11
	THERMOPLASTIC SHELL TYPE - SOLDER	15
	AC "Z" SERIES XLR METAL CHASSIS MOUNT CONNECTORS	18
	METAL D TYPE FLANGE - SOLDER AND PCB	19
	METAL P TYPE FLANGE - SOLDER AND PCB	22
	AC SERIES XLR PCB CHASSIS MOUNT CONNECTORS	28
	THERMOPLASTIC A - TYPE FLANGE 3 CONTACT	29
	METAL B - TYPE FLANGE 3 CONTACT	32
	THERMOPLASTIC A - TYPE FLANGE 5 CONTACT	36
	AC SERIES DUAL 1/4" (6.35mm) / XLR	43
	C - TYPE LOW PROFILE DUAL JACK / XLR CONNECTORS	NEW ITEMS 44
	C - TYPE DUAL JACK / XLR CONNECTORS	46
	SP/HP/EP/AP SERIES HIGH POWER / LOUDSPEAKER CONNECTORS	52
	SP SERIES LOUDSPEAKER CONNECTORS	53
	HP POWER CONNECTORS	NEW ITEMS 62
	EP METAL TYPE - SOLDER	64
	AP THERMOPLASTIC TYPE - SOLDER	66
	XLRnet SERIES	70
	RJ45 CABLE PLUG HOUSING	70
	RJ45 PCB CHASSIS MOUNT CONNECTORS	NEW ITEMS 73
	BNC 75 Ω RF CONNECTORS	81
	BNC 75Ω RF CONNECTORS	82
	BNC PATCH PANELS	84
	1/4" PHONE CONNECTORS	87
	T-SERIES	89
	T-SERIES SWITCHPLUG	91
	MUSICIAN SERIES II	96
	1/4" PHONE JACK CONNECTORS	101
	PLUGS AND SOCKETS	111
	3.5mm K-SERIES	112
	RCA SERIES	115
	G-TYPE MINIATURE XLR	118
	MULTIPIN CONNECTORS	122
	MP-41 SERIES	123
	MP-62/MP-65 SERIES	128
	ACCESSORIES	NEW ITEMS 132
	CONNECTOR WIRING INFORMATION	135
	INDEX	137



ISO VIEW OF AX SERIES XLR CABLE CONNECTOR

One piece ground / latch spring design incorporating twin wipe contacts for a direct connection path from mating shell to ground providing enhanced connection and EMI performance

Leading first mate last break socket contact (Pin 1)

Oversized ergonomic latch for quick and easy mating

O-ring provides vibration resistance and sealing.

Zinc Diecast Shell for robustness and wear resistance.

Ergonomic sleeve with integrated expansion ring. Channel I.D capability.

Concealed latching point for improved aesthetics, sealing and strength.

Ground solder tag.

Precision socket contacts with compact solder buckets reduce termination time and material wastage during soldering.

Concentric socket contact design provides optimal contact resistance

Chuck style cable clamp c/w split opening for the widest cable acceptance range

Overmolded boot with flex bend relief for improved aesthetics, cable protection and boot retention.

Ground solder tag.

Precision Machined Pin contacts with compact solder buckets reduce termination time and material wastage during soldering.

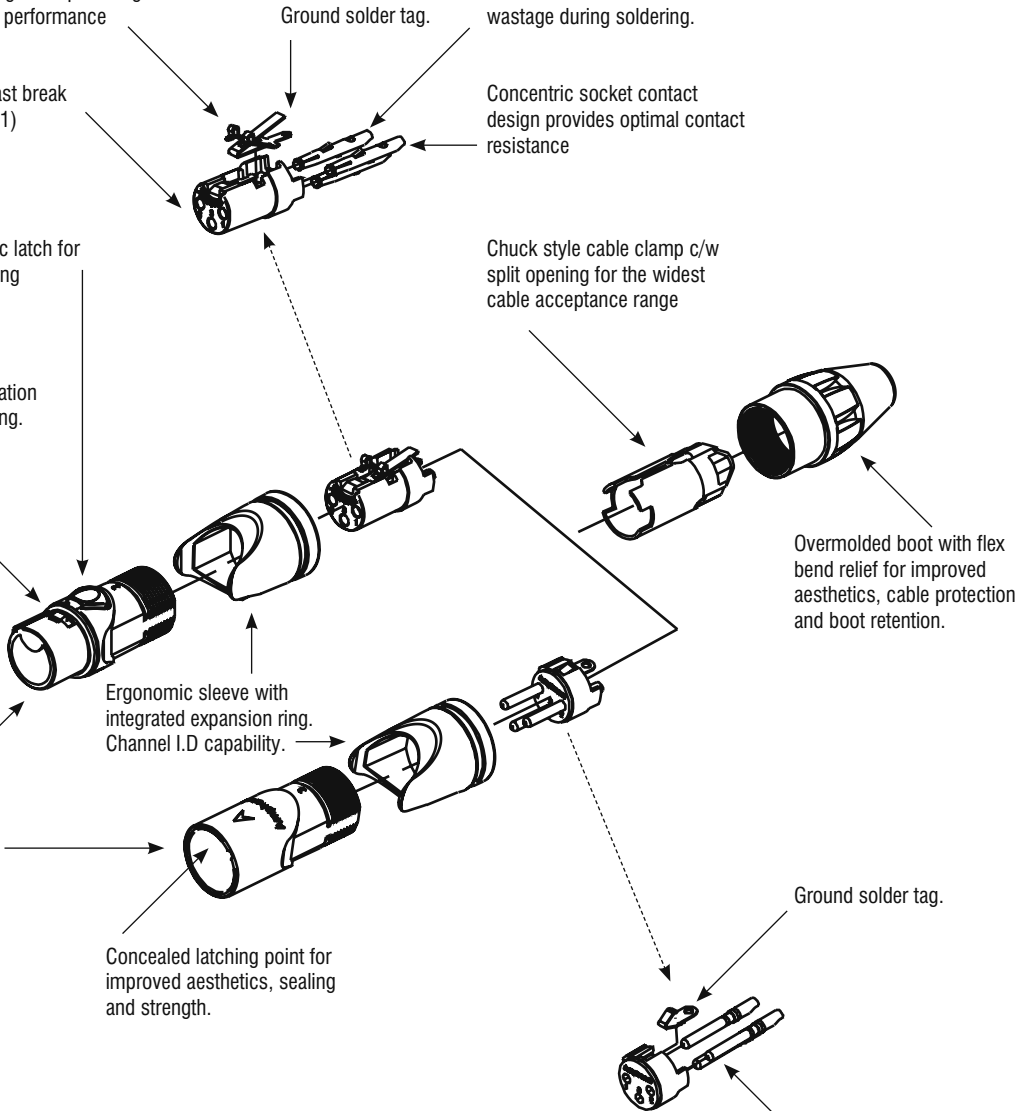



AX SERIES XLR CABLE CONNECTORS

The revolutionary AX series of XLR connectors introduce an exciting contemporary look and feel to the professional audio interconnect market. They are designed to complement modern audio architecture and truly "fit" within their environment. An impressive list of features guarantees pure sound performance in the most demanding applications providing unrivalled value.

Features

- Unique Australian designed shell and housing.
- One piece ground / latch spring design incorporating twin wipe contacts for a direct connection path from mating shell to ground providing enhanced connection and EMI performance.
- Ergonomic sleeve design for improved grip.
- Channel I.D capability with coloured sleeves.
- Oversized ergonomic latch for quick and easy mating.
- Leading first mate last break pin 1 on socket connectors.
- Chuck style cable clamp to suit 3mm - 8mm (0.118" - 0.314") cable O.D. with integrated split to allow inclusion after soldering.
- Concealed latching point for improved aesthetics, sealing and strength.
- Overmolded boot with flex bend relief for improved aesthetics, cable protection and boot retention.
- Concentric socket contact design provides optimal contact resistance
- Precision machined pin contacts as standard.
- Compact solder buckets to reduce termination time and material wastage during the soldering process.
- Zinc diecast shell housing for robustness and wear with Satin nickel or Black finish.
- Available in 3,4 and 5 contact arrangements.

Options

- Coloured I.D sleeves.
- Satin nickel or Black shell finish.
- Single or Bulk packaging.
- Gold plated contacts.

Ordering Codes

We have listed the more common ordering codes in each section. For further options please refer to the part number breakdown charts. Please contact us if you need any further assistance.

Simple steps to guide you in using this catalogue

- 1) Identify the product group listed in Contents on page 1 and go directly to that page number.
- 2) Each product group cover page then details information and options available.
- 3) Refer to the product detail pages and identify the product you require pictorially.
- 4) Read the product description column for the products standard features.
- 5) Use variations column to determine your choice.
- 6) Identify part number.
- 7) In the event the particular option you require is not listed please refer to the part number breakdown page at the end of each section.
- 8) Please contact us directly if you have any further problems.



Features:

- Unique Australian designed shell and housing.
- Ergonomic stylish sleeve design for improved grip.
- Oversized latch lever preserves your thumb.
- Leading first mate last break pin 1 on socket connectors.
- Chuck style cable clamp to suit 3mm - 8mm (0.118" - 0.314") cable O.D. with integrated split to allow inclusion after soldering.
- Overmolded cable support boot.
- New socket contact design for improved contact resistance.
- Precision machined pin contacts as standard.
- Compact solder buckets to reduce soldering time and wastage.
- Zinc diecast shell housing with Satin nickel or Matt black finish.
- Available in 3,4 and 5 contact arrangements.

Options:

- Coloured I.D sleeves.
- Satin nickel or Matt black shell finish.
- Single or Bulk packaging.

Part Number Breakdown: Page 6

Specifications: Page 9

Assembly Instructions: Page 7 & 8

PRODUCT - FIGURE	DRAWING Dimensions in mm (inches)	DESCRIPTION	VARIATIONS	PART NUMBER
		XLR 3 pole male Machined contacts Nickel Finish	Standard Gold Plated Contacts Bulk Pack	AX3M AX3M-AU AX3M BULK
		XLR 3 pole male Machined contacts Black Finish	Standard Gold Plated Contacts Bulk Pack	AX3MB AX3MB-AU AX3MB BULK
		XLR 3 pole female Stamped contacts Nickel Finish	Standard Gold Plated Contacts Bulk Pack	AX3F AX3F-AU AX3F BULK
		XLR 3 pole female Stamped contacts Black Finish	Standard Gold Plated Contacts Bulk Pack	AX3FB AX3FB-AU AX3FB BULK
		XLR 4 pole male Machined contacts Nickel Finish	Standard Gold Plated Contacts Bulk Pack	AX4M AX4M-AU AX4M BULK

*PI538 is available for download at www.amphenolaudio.com



PRODUCT - FIGURE	DRAWING Dimensions in mm (inches)	DESCRIPTION	VARIATIONS	PART NUMBER
		XLR 4 pole male Machined contacts Black Finish	Standard	AX4MB
			Gold Plated Contacts	AX4MB-AU
			Bulk Pack	AX4MB BULK
		XLR 4 pole female Machined contacts Nickel Finish	Standard	AX4F
			Gold Plated Contacts	AX4F-AU
			Bulk Pack	AX4F BULK
		XLR 4 pole female Machined contacts Black Finish	Standard	AX4FB
			Gold Plated Contacts	AX4FB-AU
			Bulk Pack	AX4FB BULK
		XLR 5 pole male Machined contacts Nickel Finish	Standard	AX5M
			Gold Plated Contacts	AX5M-AU
			Bulk Pack	AX5M BULK
		XLR 5 pole male Machined contacts Black Finish	Standard	AX5MB
			Gold Plated Contacts	AX5MB-AU
			Bulk Pack	AX5MB BULK
		XLR 5 pole female Machined contacts Nickel Finish	Standard	AX5F
			Gold Plated Contacts	AX5F-AU
			Bulk Pack	AX5F BULK
		XLR 5 pole female Machined contacts Black Finish	Standard	AX5FB
			Gold Plated Contacts	AX5FB-AU
			Bulk Pack	AX5FB BULK



PART NUMBER BREAKDOWN

METAL SHELL TYPE - SOLDER

E. G. **AX3MB2-AU BULK**
AX (Series Prefix), **3** contacts, **M**ale, **B**lack Finish,
2 (Red Sleeve)- **AU** (Gold Plated Contacts), **BULK** Packaged.

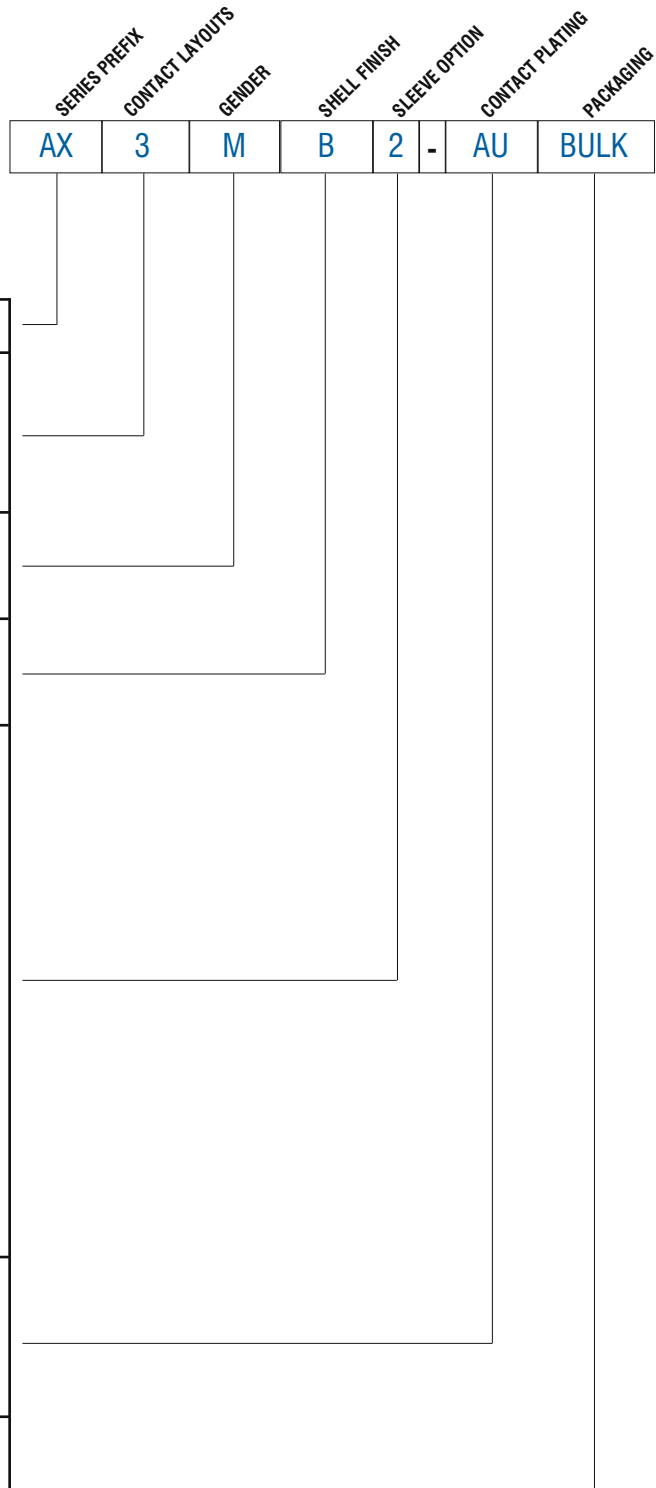

SERIES PREFIX	AX	=	Series Prefix
CONTACT LAYOUTS	3	=	3 Contacts
	4	=	4 Contacts
	5	=	5 Contacts
GENDER	F	=	Female Socket Contacts
	M	=	Male Pin Contacts
SHELL FINISH	Blank	=	Nickel Plated Finish
	B	=	Black Finish
SLEEVE OPTION	1	=	Brown
	2	=	Red
	3	=	Orange
	4	=	Yellow
	5	=	Green
	6	=	Blue
	7	=	Violet
	8	=	Grey
	9	=	White
CONTACT PLATING	Blank	=	Standard Plating (Silver or Tin - Refer to Standard Data.)
	AU	=	Gold Plated
PACKAGING	Blank	=	Individual Bags
	BULK	=	Bulk Packed



PI539 ASSEMBLY INSTRUCTIONS

AX SERIES FEMALE XLR
CABLE CONNECTOR

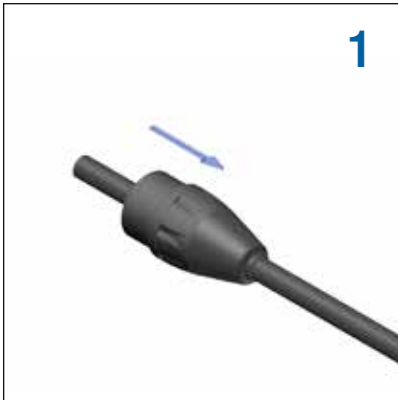

1

Slide the nut (Backshell) onto the cable

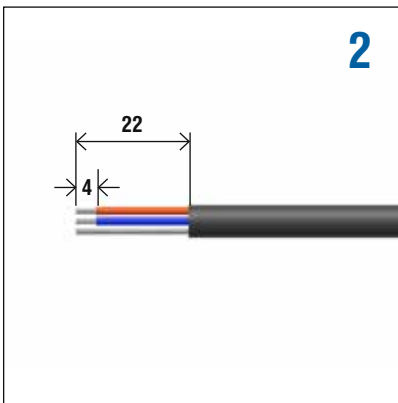

2

Strip the cable

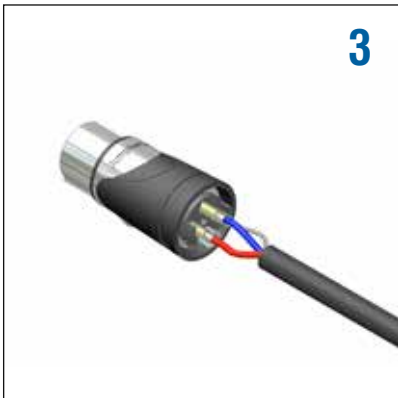

3

Push back the insert only enough to expose the solder buckets. It is not necessary to remove the insert. Solder the wires to the contacts.



4

Install the cable clamp, flush to the insert making sure to align the top slot with the spring. Then push the insert & cable clamp together into the shell.



5

Thread the nut (Backshell) onto the shell (Torque 0.8Nm - 1.2Nm) to activate the cable clamp and close the connector assembly.

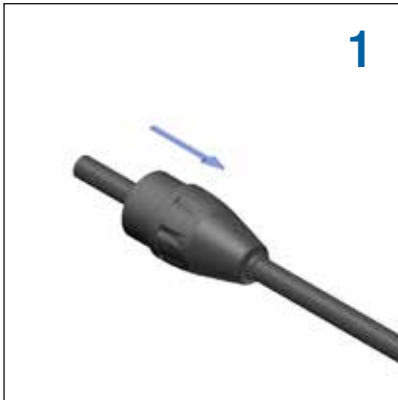

1

Slide the nut (Backshell) onto the cable

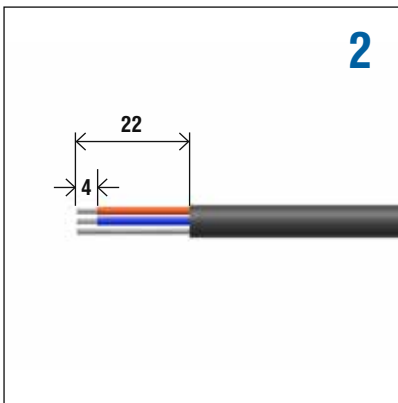

2

Strip the cable

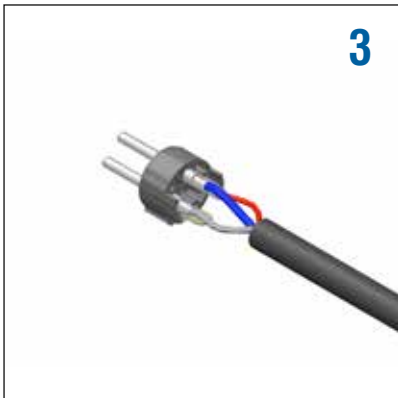

3

Solder the wires to the contacts.



4

Install the cable clamp flush to the insert making sure to align the slot with the ground contact.



5

Align the key of the insert with the keyway on the shell then push the pin insert & cable clamp together in the shell.

PI538 ASSEMBLY INSTRUCTIONS

AX SERIES MALE XLR
CABLE CONNECTOR

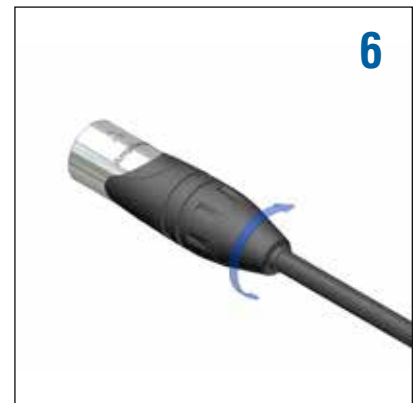

6

Thread the nut (Backshell) onto the shell (Torque 0.8Nm - 1.2Nm) to activate the cable clamp and close the connector assembly.

STANDARD DATA AX SERIES CABLE CONNECTORS

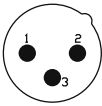
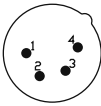
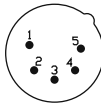

		VALUE		
GENERAL CHARACTERISTICS	Number of contacts	3	4	5
	AX Series Contact Arrangements (Front view of pin inserts)			
	Termination	SOLDER		
	Max. Wire Gauge - Stranded wire: Solder	14AWG	16AWG	18AWG
	Flammability rating of insulator plastics and housings	UL94V-0		
	Environmental	Complies with EU RoHS 2 Directive 2011/65/EU		
ELECTRICAL CHARACTERISTICS	Service Voltage RMS	133V ¹⁾		
	Test Voltage AC RMS	1400V		
	Current carrying capacity: Solder	15A	10A	7.5A
	Typical Contact Resistance	≤3m Ω		
	Insulation Resistance	≥1G Ω		
CLIMATIC CHARACTERISTICS	Protection Class	IP40		
	Operating Temperature	-25 °C to +75 °C (-13°F to +167°F)		
MECHANICAL CHARACTERISTICS	Insertion and Withdrawal force	≥10N - ≤30N		
	Weight ²⁾	31g (0.068lb)	33g (0.073lb)	33g (0.073lb)
	Typical Cable retention force	22Kg to 44Kg (50lb to 100lb) - Dependent on cable material and diameter.		
	Cable O.D. range	3mm to 8mm (0.118" to 0.314")		
	Mechanical Operations	1000 mating cycles		
MATERIALS	Connector shell - Metal Shell finish	Diecast Zinc Alloy Satin nickel or Black		
	Insulators	UL94V-0 PA66, 30% Glass Filled		
	Boot / Backshell Finish	UL94V-0 Noryl N190 / Santoprene Black, other colours available - see page 80		
	Cable clamp	Noryl N190		
	Sleeve	Noryl N190		
	Male Contact Machined - Solder / Plating	Brass / Silver or Gold (Optional)		
	Female Contact Stamped - Solder / Plating	Phosphor Bronze / Tin or Gold (Optional)		

Rev 3 - 03/2013

¹⁾ Not suitable for domestic applications above 50V

²⁾ Approximate weight only, does not include packaging. Please contact us for exact weight for shipping purposes.

Amphenol

AC SERIES XLR CABLE CONNECTORS



Amphenol Australia have been manufacturing and designing innovative XLR connectors since 1955. The AC series cable connector range complies with IEC268-12 and AES 14-1992 standards.
CSA File Number 68598.

Features

- AC series XLR connectors feature the unique Australian design and patented "Jaws" cable retention system
- A leading first mate last break socket contact is standard on all female connectors (Pin 1).
- The "Jaws" cable retention system provides up to 44kg (100lb) of strain.
- The AC series connector can be quickly and easily assembled without screws – by hand or portable termination tool. (Part number T2860)
- Available in 3, 4, 5, 6A and 7 contact arrangements.
- Compatible with all other XLR brands.

Options

- Solder Bucket termination
- Thermoplastic shell
- Zinc Diecast shell - Satin Nickel Finish
- Zinc Diecast shell - Black Polyester Finish
- Gold, Silver or Tin Plated contacts
- Bulk Style Packaging
- Single Bag packs
- Precision machined contacts
- Cost effective stamped contacts on 3 pole
- Standard Jaws cable clamp, Cable O.D 3mm to 6.5mm (0.118" to 0.255")
- Large Jaws cable clamp, Cable O.D 6.5mm to 8mm (0.255" to 0.314")
- Metal Boots / Backshells
- Coloured Boots / Backshells
- Coloured Identification rings
- Termination / Assembly tooling

Jaws Cable Clamp Options



Standard Jaws cable clamp (Black), Cable O.D 3mm to 6.5mm (0.118" to 0.255")



Large Jaws cable clamp (Purple), Cable O.D 6.5mm to 8mm (0.255" to 0.314")

Ordering Codes

We have listed the more common ordering codes in each section. For further options please refer to the part number breakdown charts. Please contact us if you need any further assistance.

Simple steps to guide you in using this catalogue

- 1) Identify the product group listed in Contents on page 1 and go directly to that page number.
- 2) Each product group cover page then details information and options available.
- 3) Refer to the product detail pages and identify the product you require pictorially.
- 4) Read the product description column for the products standard features.
- 5) Use variations column to determine your choice.
- 6) Identify part number.
- 7) In the event the particular option you require is not listed please refer to the part number breakdown page at the end of each section.
- 8) Please contact us directly if you have any further problems.



Features:









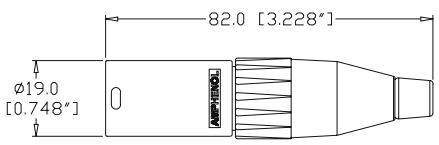

- Zinc Diecast Shell.
- Solder Bucket connections.
- "Jaws" Cable Retention System.
- Contact layouts in 3, 4, 5, 6A and 7.
- Precision machined or Stamped contacts.
- Leading first mate last break socket contact.
- Quick and easy assembly without screws – by hand or portable termination tool. (Part number T2860.)

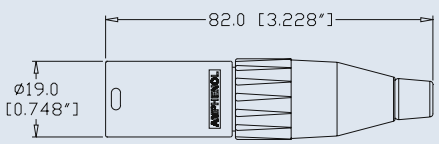

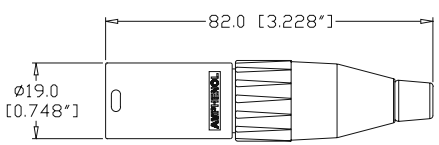

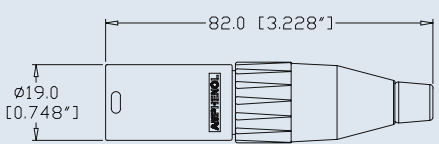

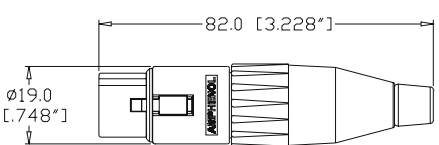

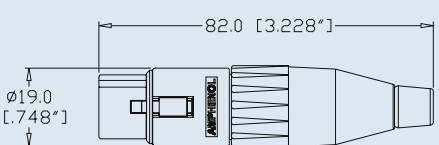

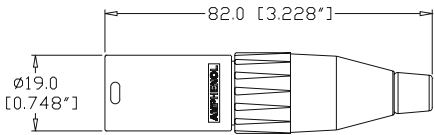

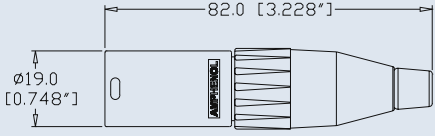

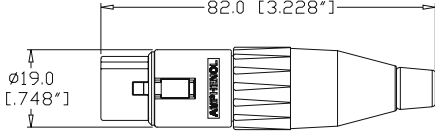
Options: Stamped Contacts (3 contact only), Gold plated contacts, Large or Small Jaws Cable Clamp, Black Finish Shell, Bulk Pack, Coloured Boots / Backshells

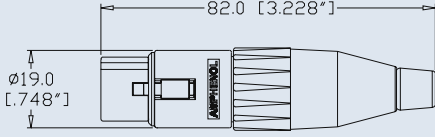

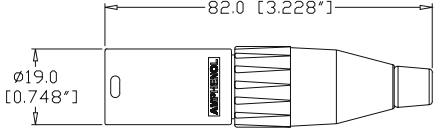

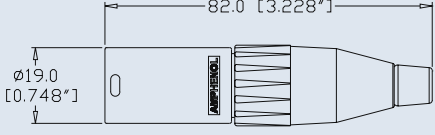

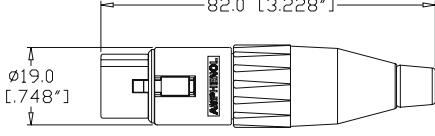

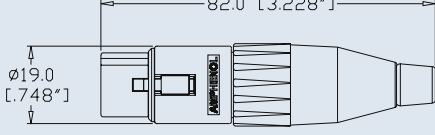

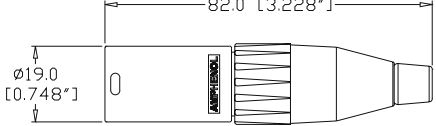

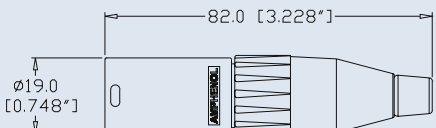

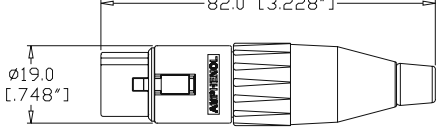
Part Number Breakdown: Page 14

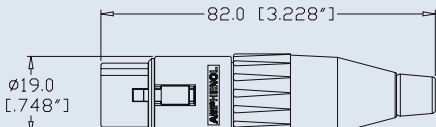
Specifications: Page 16

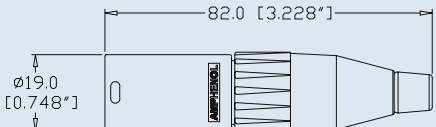

PRODUCT - FIGURE	DRAWING	DESCRIPTION	VARIATIONS	PART NUMBER
		XLR 3 pole male, Machined contacts, Nickel Finish, Jaws cable clamp	Standard	AC3MM
			Gold Plated Contacts	AC3MM-AU
			Large Cable Clamp	AC3MMJ
			Bulk Pack	AC3MM BULK
		XLR 3 pole male, Machined contacts, Black Finish, Jaws cable clamp	Standard	AC3MMB
			Gold Plated Contacts	AC3MMB-AU
			Large Cable Clamp	AC3MMBJ
			Bulk Pack	AC3MMB BULK
		XLR 3 pole male, Stamped contacts, Nickel Finish, Jaws cable clamp	Standard	AC3M
			Gold Plated Contacts	AC3M-AU
			Large Cable Clamp	AC3MJ
			Bulk Pack	AC3M BULK
		XLR 3 pole male, Stamped contacts, Black Finish, Jaws cable clamp	Standard	AC3MB
			Gold Plated Contacts	AC3MB-AU
			Large Cable Clamp	AC3MBJ
			Bulk Pack	AC3MB BULK
		XLR 3 pole female, Stamped contacts, Nickel Finish, Jaws cable clamp	Standard	AC3F
			Gold Plated Contacts	AC3F-AU
			Large Cable Clamp	AC3FJ
			Bulk Pack	AC3F BULK
		XLR 3 pole female, Stamped contacts, Black Finish, Jaws cable clamp	Standard	AC3FB
			Gold Plated Contacts	AC3FB-AU
			Large Cable Clamp	AC3FBJ
			Bulk Pack	AC3FB BULK

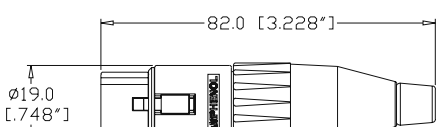
PRODUCT - FIGURE	DRAWING Dimensions in mm (inches)	DESCRIPTION	VARIATIONS	PART NUMBER
		XLR 4 pole male, Machined contacts, Nickel Finish, Jaws cable clamp	Standard	AC4M
			Gold Plated Contacts	AC4M-AU
			Large Cable Clamp	AC4MJ
			Bulk Pack	AC4M BULK
		XLR 4 pole male, Machined contacts, Black Finish, Jaws cable clamp	Standard	AC4MB
			Gold Plated Contacts	AC4MB-AU
			Large Cable Clamp	AC4MBJ
			Bulk Pack	AC4MB BULK
		XLR 4 pole female, Machined contacts, Nickel Finish, Jaws cable clamp	Standard	AC4F
			Gold Plated Contacts	AC4F-AU
			Large Cable Clamp	AC4FJ
			Bulk Pack	AC4F BULK
		XLR 4 pole female, Machined contacts, Black Finish, Jaws cable clamp	Standard	AC4FB
			Gold Plated Contacts	AC4FB-AU
			Large Cable Clamp	AC4FBJ
			Bulk Pack	AC4FB BULK
		XLR 5 pole male, Machined contacts, Nickel Finish, Jaws cable clamp	Standard	AC5M
			Gold Plated Contacts	AC5M-AU
			Large Cable Clamp	AC5MJ
			Bulk Pack	AC5M BULK
		XLR 5 pole male, Machined contacts, Black Finish, Jaws cable clamp	Standard	AC5MB
			Gold Plated Contacts	AC5MB-AU
			Large Cable Clamp	AC5MBJ
			Bulk Pack	AC5MB BULK
		XLR 5 pole female, Machined contacts, Nickel Finish, Jaws cable clamp	Standard	AC5F
			Gold Plated Contacts	AC5F-AU
			Large Cable Clamp	AC5FJ
			Bulk Pack	AC5F BULK
		XLR 5 pole female, Machined contacts, Black Finish, Jaws cable clamp	Standard	AC5FB
			Gold Plated Contacts	AC5FB-AU
			Large Cable Clamp	AC5FBJ
			Bulk Pack	AC5FB BULK

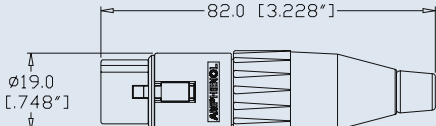
PRODUCT - FIGURE	DRAWING Dimensions in mm (inches)	DESCRIPTION	VARIATIONS	PART NUMBER
		XLR 6A pole male, Machined contacts, Nickel Finish, Jaws cable clamp	Standard	AC6AM
			Gold Plated Contacts	AC6AM-AU
			Large Cable Clamp	AC6AMJ
			Bulk Pack	AC6AM BULK
		XLR 6A pole male, Machined contacts, Black Finish, Jaws cable clamp	Standard	AC6AMB
			Gold Plated Contacts	AC6AMB-AU
			Large Cable Clamp	AC6AMBJ
			Bulk Pack	AC6AMB BULK
		XLR 6A pole female, Machined contacts, Nickel Finish, Jaws cable clamp	Standard	AC6AF
			Gold Plated Contacts	AC6AF-AU
			Large Cable Clamp	AC6AFJ
			Bulk Pack	AC6AF BULK
		XLR 6A pole female, Machined contacts, Black Finish, Jaws cable clamp	Standard	AC6AFB
			Gold Plated Contacts	AC6AFB-AU
			Large Cable Clamp	AC6AFBJ
			Bulk Pack	AC6AFB BULK
		XLR 7 pole male, Gold plated Machined contacts, Nickel Finish, Jaws cable clamp	Standard	AC7M
			Large Cable Clamp	AC7MJ
			Bulk Pack	AC7M BULK
		XLR 7 pole male, Gold plated Machined contacts, Black Finish, Jaws cable clamp	Standard	AC7MB
			Large Cable Clamp	AC7MBJ
			Bulk Pack	AC7MB BULK
		XLR 7 pole female, Gold plated Machined contacts, Nickel Finish, Jaws cable clamp	Standard	AC7F
			Large Cable Clamp	AC7FJ
			Bulk Pack	AC7F BULK
		XLR 7 pole female, Gold plated Machined contacts, Black Finish, Jaws cable clamp	Standard	AC7FB
			Large Cable Clamp	AC7FBJ
			Bulk Pack	AC7FB BULK



PART NUMBER BREAKDOWN

METAL SHELL TYPE - SOLDER

E. G. **AC3MMBJ-AU BULK**

AC (Series Prefix), **3** contacts, **Male**, **Machined Contacts**, **Black Polyester Finish**, **J** (Large Jaws), - **AU** (Gold Plated Contacts), **Bulk** Packaged.

SERIES PREFIX CONTACT LAYOUTS GENDER CONTACT SHELL FINISH CABLE CLAMP CONTACT PLATING PACKAGING

AC 3 M M B J - AU BULK

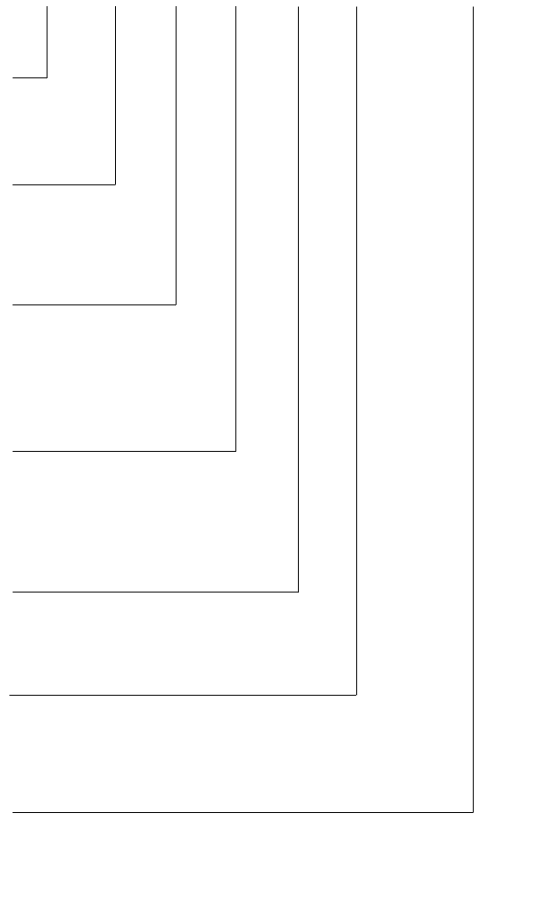

SERIES PREFIX	AC = Series Prefix
CONTACT LAYOUTS	3 = 3 Contacts 4 = 4 Contacts 5 = 5 Contacts 6A = 6 Contacts 7 = 7 Contacts
GENDER	F = Female Socket Contacts M = Male Pin Contacts
CONTACT¹	Blank = Stamped Contacts M = Machined Contacts G = Stamped Contacts, Ground Tag MG = Machined Contacts, Ground Tag (Applicable 3 male pin contacts, option M & MG only)
SHELL FINISH²	Blank = Nickel Plated Finish B = Black Polyester Finish
CABLE CLAMP	Blank = Standard Jaws 3mm - 6.5mm cable O.D. (0.118" to 0.255") J = Large Jaws 6.5mm - 8mm cable O.D. (0.255" to 0.314")
CONTACT PLATING³	Blank = Standard Plating (Silver or Tin) (Refer to Standard Data) AU = Gold Plated
PACKAGING	Blank = Individual Bags BULK = Bulk Packed

ISO VIEW OF AC3MM

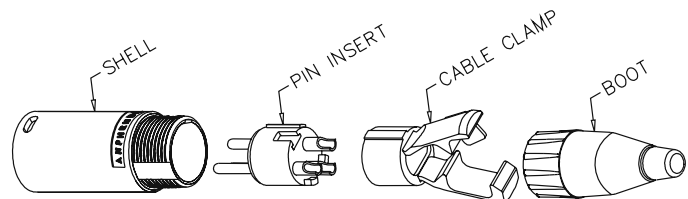

Note:

- ¹ 4 - 7 contact connectors have machined contacts and grounding as standard.
- ² Ground contacts are not supplied with the black polyester finish shell option.
- ³ 7 Contact is gold plated as standard.
- ⁴ All AC Series Connectors are available with optional colour coded boot / backshell. Refer to page 134 and simply add colour to end of part number. Example: AC3MM - RED



Features:

- Thermoplastic Shell.
- Solder Bucket Connections.
- “Jaws” Cable Retention System.
- Stamped or Machined Contacts.
- Leading first mate last break socket contact.
- Quick and easy assembly without screws – by hand or portable termination tool. (Part number T2860.)

Options: Gold Plated Contacts, Stamped Contacts (3 Contact only), Bulk Pack, Coloured Boots / Backshells
3, 4, 5, 6A and 7 Contacts.

Specifications: Page 16



PRODUCT - FIGURE	DRAWING	DESCRIPTION	VARIATIONS	PART NUMBER
		XLR 3 pole male, Machined contacts, Thermoplastic shell, Jaws cable clamp	Standard	AC3MMCP
			Gold Plated Contacts	AC3MMCP-AU
			Large Cable Clamp	AC3MMCPJ
			Bulk Pack	AC3MMCP BULK
		XLR 3 pole male, Stamped contacts, Thermoplastic shell, Jaws cable clamp	Standard	AC3MCP
			Gold Plated Contacts	AC3MCP-AU
			Large Cable Clamp	AC3MCPJ
			Bulk Pack	AC3MCP BULK
		XLR 3 pole female, Stamped contacts, Thermoplastic shell, Jaws cable clamp	Standard	AC3FCP
			Gold Plated Contacts	AC3FCP-AU
			Large Cable Clamp	AC3FCPJ
			Bulk Pack	AC3FCP BULK

Note: Thermoplastic shell connectors are also available in 4 - 7 contact arrangements, please contact us for ordering code.

ISO VIEW OF AC3MM

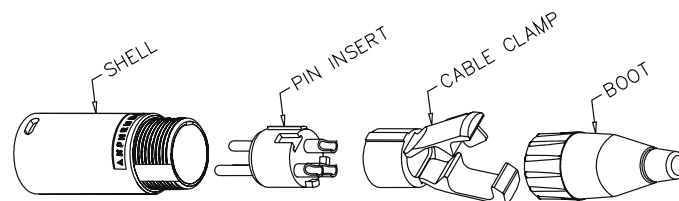

STANDARD DATA AC CABLE CONNECTORS

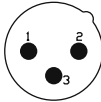
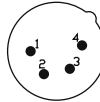
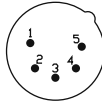
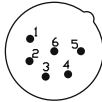
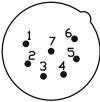
		VALUE				
GENERAL CHARACTERISTICS	Number of contacts	3	4	5	6A	7
	AC Series Contact Arrangements (Front view of pin inserts)					
	Termination	SOLDER				
	Max. Wire Gauge - Stranded wire: Solder	14AWG	16AWG	18AWG		20AWG
	Flammability rating of insulator plastics and housings	UL94V-0				
	Environmental	Complies with EU RoHS 2 Directive 2011/65/EU				
ELECTRICAL CHARACTERISTICS	Service Voltage RMS	133V ¹				
	Test Voltage AC RMS	1400V				
	Current carrying capacity: Solder	15A	10A	7.5A		5A
	Typical Contact Resistance	≤3mΩ				
	Insulation Resistance	≥1GΩ				
CLIMATIC CHARACTERISTICS	Protection Class	IP40				
	Operating Temperature	-25 °C to +75 °C (-13°F to +167°F)				
MECHANICAL CHARACTERISTICS	Insertion and Withdrawal force	≥10N - ≤30N				
	Weight - Metal ²	36g (0.080lb)	37g (0.081lb)	38g (0.083lb)		
	Weight - Thermoplastic ²	18g (0.039lb)	19g (0.041lb)	20g (0.044lb)		
	Typical Cable retention force	22Kg to 44Kg (50lb to 100lb) - Dependent on cable material and diameter.				
	Cable O.D. range - JAWS clamp Standard Solder Large Solder	3mm to 6.5mm (0.118" to 0.255") 6.5mm to 8mm (0.255" to 0.314")				
	Mechanical Operations	1000 mating cycles				

Rev 6 - 03/2015

¹⁾ Not suitable for domestic applications above 50V

²⁾ Approximate weight only, does not include packaging. Please contact us for exact weight for shipping purposes.

STANDARD DATA AC CABLE CONNECTORS

MATERIALS		DETAILS
Connector shell - Metal	Shell finish	Diecast Zinc Alloy Satin nickel or Black polyester
Connector shell - Thermoplastic	Shell finish	Thermoplastic, UL94V-0 Modified PPE Resin Black
Insulators		UL94V-0 PBT Resin or Modified PPE Resin
Boot / Backshell	Finish	UL94V-0 Modified PPE Resin or Machined Brass Black, other colours available - see page 134
Cable clamp	Standard Solder JAWS Large Solder JAWS	UL94V-0 Modified PPO Resin (Black) UL94V-0 Modified PPO Resin (Purple)
Cable Bushing		Santoprene
Male Contact	Stamped - Solder / Plating Machined - Solder / Plating	Phosphor Bronze / Silver or Gold (Optional) Brass / Silver or Gold (Optional)
Female Contact	Stamped - Solder / Plating Machined - Solder / Plating	Phosphor Bronze / Tin or Gold (Optional) Brass / Silver or Gold (Optional)



Rev 6 - 03/2015

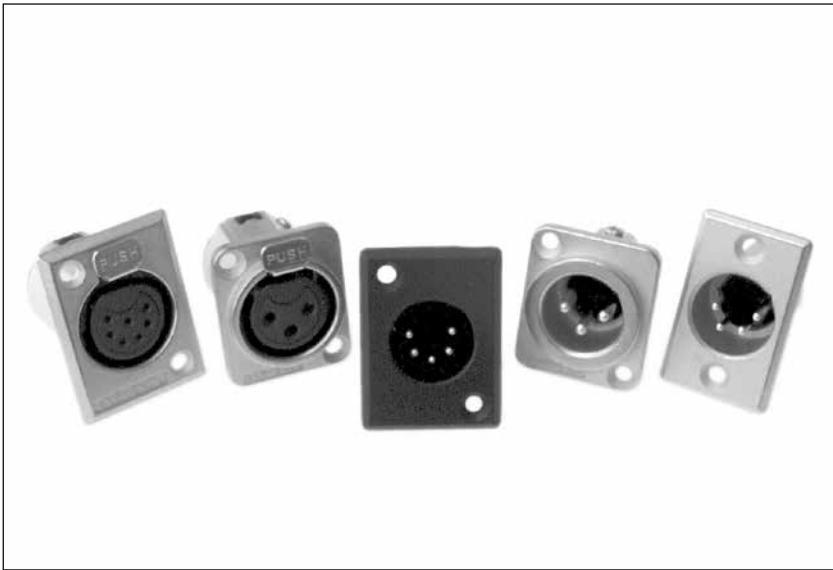

AC “Z” SERIES XLR METAL CHASSIS MOUNT CONNECTORS

The metal chassis mount “Z” series connectors are designed for the audio user where durability, reliability and strength across a wide range of applications are important. All AC products are manufactured to the highest quality standards and will withstand the harshest environments. This range complies with IEC268-12 and AES 14-1992 standards. CSA File Number 68598

Note: A ground tag is standard on all AC “Z” series connectors. Although the ground tag is intended for RFI shielding applications, Amphenol cannot guarantee its effectiveness in all cases.

The non-conductive Black polyester finish insulates the ground tag from the shell and should not be used in applications requiring ground contact to the shell.

Simple steps to guide you in using this catalogue

- 1) Identify the product group listed in Contents on page 1 and go directly to that page number.
- 2) Each product group cover page then details information and options available.
- 3) Refer to the product detail pages and identify the product you require pictorially.
- 4) Read the product description column for the products standard features.
- 5) Use variations column to determine your choice.
- 6) Identify part number.
- 7) In the event the particular option you require is not listed please refer to the part number breakdown page at the end of each section.
- 8) Please contact us directly if you have any further problems.

Features

- The “D” size housing can be either front or rear mounted using the same panel cutout.
- The “P” size housing is the original wide flange front mounting XLR connector. “PN” is the original narrow flange front mounting male connector.
- A leading first mate last break socket contact is standard on all female connectors (Pin 1).
- Solder cup or Vertical PCB versions.
- Connectors are fitted with a grounding system for RFI shielding applications.
- Available in 3, 4, 5, 6A and 7 contact arrangements.
- Compatible with all other XLR brands.

Options

- Solder Bucket termination
- Vertical PCB contacts
- Zinc Diecast Shell - Satin Nickel Finish
- Zinc Diecast Shell - Black Polyester Finish
- Gold, Silver or Tin Plated Contacts
- Bulk Packaging
- Single Bag packs
- Precision machined contacts
- Cost effective stamped contacts on 3 pole
- Latchless versions (Non-Latching) (Female only)

Ordering Codes

We have listed the more common ordering codes in each section. For further options please refer to the part number breakdown charts. Please contact us if you need any further assistance.



Features:

- Zinc Diecast Shell.
- D size housing can be front or rear mounted using the same panel cutout.
- Solder Bucket connections.
- Vertical PCB mounting (not available in 4 contact female).
- Precision machined or Stamped contacts (3 pin only).
- Leading first mate last break socket contact.
- Positive latch lock system.

Options: Stamped contacts (3 contact only), Gold plated contacts, Vertical PCB contacts, Black finish, Non-Latching (Female only), Bulk Pack.

Part Number Breakdown: Page 25











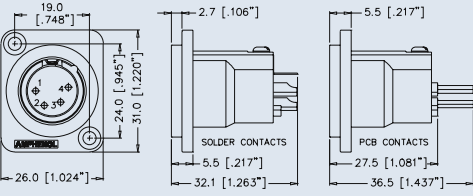

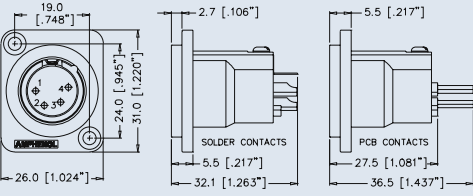

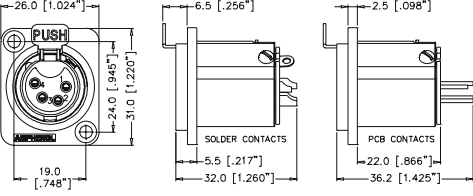
Specifications: Page 26

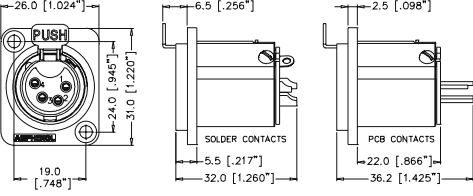
PCB Footprints: Page 27

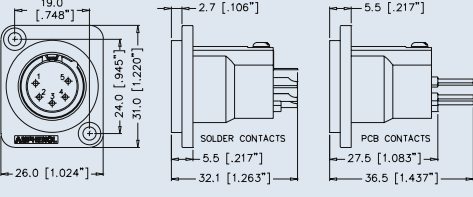
Panel Cutouts: Page 27

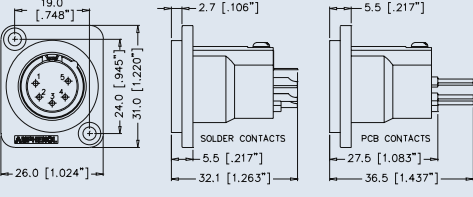

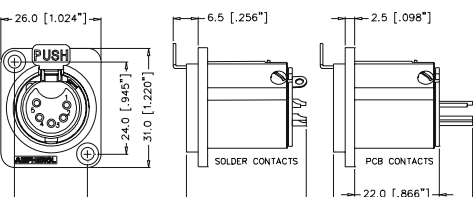
PRODUCT - FIGURE	DRAWING	Dimensions in mm (inches)	DESCRIPTION	VARIATIONS	PART NUMBER
		<p>SOLDER CONTACTS: 5.5 [.217\"/> </p>	XLR 3 pole male, D Flange, Machined contacts, Nickel Finish	Standard	AC3MMDZ
			Gold Plated Contacts	AC3MMDZ-AU	
			Vertical PCB	AC3MMDZV	
			Bulk Pack	AC3MMDZ BULK	
		<p>SOLDER CONTACTS: 5.5 [.217\"/> </p>	XLR 3 pole male, D Flange, Machined contacts, Black Finish	Standard	AC3MMDZB
			Gold Plated Contacts	AC3MMDZB-AU	
			Vertical PCB	AC3MMDZVB	
			Bulk Pack	AC3MMDZB BULK	
		<p>SOLDER CONTACTS: 5.5 [.217\"/> </p>	XLR 3 pole male, D Flange, Stamped contacts, Nickel Finish	Standard	AC3MDZ
			Gold Plated Contacts	AC3MDZ-AU	
			Bulk Pack	AC3MDZ BULK	
		<p>SOLDER CONTACTS: 5.5 [.217\"/> </p>	XLR 3 pole male, D Flange, Stamped contacts, Black Finish	Standard	AC3MDZB
			Gold Plated Contacts	AC3MDZB-AU	
			Bulk Pack	AC3MDZB BULK	
		<p>SOLDER CONTACTS: 6.5 [.256\"/> </p>	XLR 3 pole female, D Flange, Stamped contacts, Nickel Finish	Standard	AC3FDZ
			Gold Plated Contacts	AC3FDZ-AU	
			Bulk Pack	AC3FDZ BULK	
		<p>SOLDER CONTACTS: 5.5 [.217\"/> </p>	XLR 3 pole female, D Flange, Stamped contacts, Black Finish	Standard	AC3FDZB
			Gold Plated Contacts	AC3FDZB-AU	
			Bulk Pack	AC3FDZB BULK	

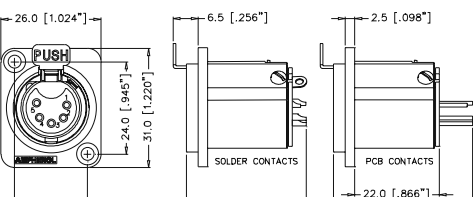
PRODUCT - FIGURE	DRAWING	Dimensions in mm (inches)	DESCRIPTION	VARIATIONS	PART NUMBER
		<p>XLR 4 pole male, D Flange, Machined contacts, Nickel Finish</p>	Standard	AC4MDZ	
			Gold Plated Contacts	AC4MDZ-AU	
			Vertical PCB	AC4MDZV	
			Bulk Pack	AC4MDZ BULK	
		<p>XLR 4 pole male, D Flange, Machined contacts, Black Finish</p>	Standard	AC4MDZB	
			Gold Plated Contacts	AC4MDZB-AU	
			Vertical PCB	AC4MDZVB	
			Bulk Pack	AC4MDZB BULK	
		<p>XLR 4 pole female, D Flange, Machined contacts, Nickel Finish</p>	Standard	AC4FDZ	
			Gold Plated Contacts	AC4FDZ-AU	
			Vertical PCB	AC4FDZV	
			Bulk Pack	AC4FDZ BULK	
		<p>XLR 4 pole female, D Flange, Machined contacts, Black Finish</p>	Standard	AC4FDZB	
			Gold Plated Contacts	AC4FDZB-AU	
			Vertical PCB	AC4FDZVB	
			Bulk Pack	AC4FDZB BULK	
		<p>XLR 5 pole male, D Flange, Machined contacts, Nickel Finish</p>	Standard	AC5MDZ	
			Gold Plated Contacts	AC5MDZ-AU	
			Vertical PCB	AC5MDZV	
			Bulk Pack	AC5MDZ BULK	
		<p>XLR 5 pole male, D Flange, Machined contacts, Black Finish</p>	Standard	AC5MDZB	
			Gold Plated Contacts	AC5MDZB-AU	
			Vertical PCB	AC5MDZVB	
			Bulk Pack	AC5MDZB BULK	
		<p>XLR 5 pole female, D Flange, Machined contacts, Nickel Finish</p>	Standard	AC5FDZ	
			Gold Plated Contacts	AC5FDZ-AU	
			Vertical PCB	AC5FDZV	
			Bulk Pack	AC5FDZ BULK	
		<p>XLR 5 pole female, D Flange, Machined contacts, Black Finish</p>	Standard	AC5FDZB	
			Gold Plated Contacts	AC5FDZB-AU	
			Vertical PCB	AC5FDZVB	
			Bulk Pack	AC5FDZB BULK	

PRODUCT - FIGURE	DRAWING	DESCRIPTION	VARIATIONS	PART NUMBER
		XLR 6A pole male, D Flange, Machined contacts, Nickel Finish	Standard	AC6AMDZ
			Gold Plated Contacts	AC6AMDZ-AU
			Vertical PCB	AC6AMDZV
			Bulk Pack	AC6AMDZ BULK
		XLR 6A pole male, D Flange, Machined contacts, Black Finish	Standard	AC6AMDZB
			Gold Plated Contacts	AC6AMDZB-AU
			Vertical PCB	AC6AMDZVB
			Bulk Pack	AC6AMDZB BULK
		XLR 6A pole female, D Flange, Machined contacts, Nickel Finish	Standard	AC6AFDZ
			Gold Plated Contacts	AC6AFDZ-AU
			Vertical PCB	AC6AFDZV
			Bulk Pack	AC6AFDZ BULK
		XLR 6A pole female, D Flange, Machined contacts, Black Finish	Standard	AC6AFDZB
			Gold Plated Contacts	AC6AFDZB-AU
			Vertical PCB	AC6AFDZVB
			Bulk Pack	AC6AFDZB BULK
		XLR 7 pole male, D Flange, Gold Plated Machined contacts, Nickel Finish	Standard	AC7MDZ
			Vertical PCB	AC7MDZV
			Bulk Pack	AC7MDZ BULK
Vertical PCB	AC7MDZVB			
Bulk Pack	AC7MDZB BULK			
		XLR 7 pole female, D Flange, Gold Plated Machined contacts, Nickel Finish		
			Vertical PCB	AC7FDZV
			Bulk Pack	AC7FDZ BULK
Vertical PCB	AC7FDZVB			
Bulk Pack	AC7FDZB BULK			



METAL P TYPE FLANGE - SOLDER AND PCB













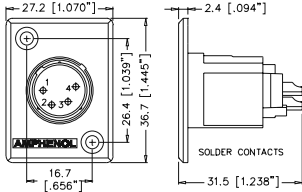

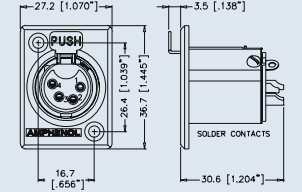

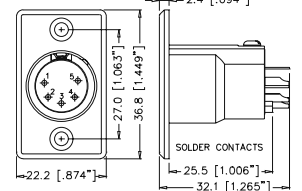
Features:

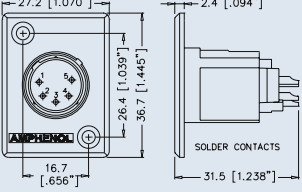
- Zinc Diecast shell.
- The P size housing is the original wide flange front mounting XLR connector. PN is the original narrow, front mounting male connector.
- Solder Bucket connections.
- Precision Machined or Stamped contacts (3 pin only).
- Leading first mate last break socket contact.
- Positive latch lock system.

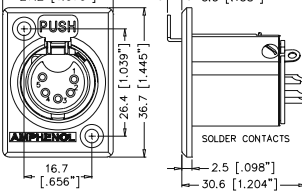

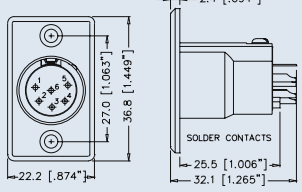

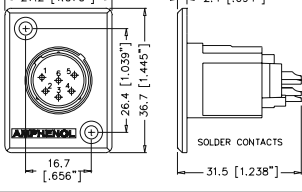
Options: Stamped contacts (3 contact only), Gold plated contacts, Black Finish, Non-Latching (Female only), Bulk Pack.

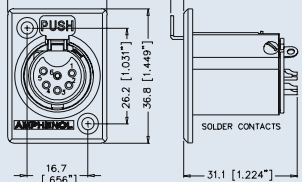
Part Number Breakdown: [Page 25](#) **Specifications:** [Page 26](#)
PCB Footprints: [Page 27](#) **Panel Cutouts:** [Page 27](#)

PRODUCT - FIGURE	DRAWING	Dimensions in mm (inches)	DESCRIPTION	VARIATIONS	PART NUMBER
		2.4 [.094"] 27.0 [1.063"] 36.8 [1.449"] 22.2 [.874"] 32.1 [1.265"]	XLR 3 pole male, Narrow flange, Machined contacts	Standard Black Finish	AC3MMPNZ AC3MMPNZB
		2.4 [.094"] 27.0 [1.063"] 36.8 [1.449"] 22.2 [.874"] 32.1 [1.265"]	XLR 3 pole male, Narrow flange, Stamped contacts,	Standard Black Finish	AC3MPNZ AC3MPNZB
		27.2 [1.070"] 26.4 [1.039"] 36.7 [1.445"] 16.7 [.656"] 31.5 [1.238"]	XLR 3 pole male, Wide flange, Machined contacts	Standard Black Finish	AC3MMP AC3MMPB
		2.4 [.094"] 27.2 [1.070"] 26.4 [1.039"] 36.7 [1.445"] 16.7 [.656"] 32.5 [1.278"]	XLR 3 pole male, Wide flange, Stamped contacts	Standard Black Finish	AC3MP AC3MPB
		27.2 [1.070"] 26.4 [1.039"] 36.7 [1.445"] 16.7 [.656"] 3.5 [1.38"] 2.5 [.098"] 31.0 [1.220"]	XLR 3 pole female, Wide flange, Stamped contacts	Standard Black Finish	AC3FPZ AC3FPZB
		2.4 [.094"] 27.0 [1.063"] 36.8 [1.449"] 22.2 [.874"] 32.1 [1.265"]	XLR 4 pole male, Narrow flange, Machined contacts	Standard Black Finish	AC4MPNZ AC4MPNZB

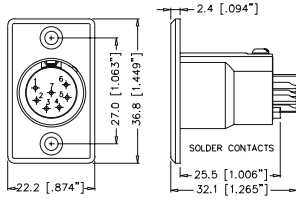
PRODUCT - FIGURE	DRAWING	Dimensions in mm (inches)	DESCRIPTION	VARIATIONS	PART NUMBER
		27.2 [1.070"] 2.4 [.094"] 26.4 [1.039"] 36.7 [1.445"] 16.7 [.656"] 31.5 [1.238"]	XLR 4 pole male, Wide flange, Machined contacts	Standard Black Finish	AC4MP AC4MPB
		27.2 [1.070"] 3.5 [.138"] 26.4 [1.039"] 36.7 [1.445"] 16.7 [.656"] 30.6 [1.204"]	XLR 4 pole female, Wide flange, Machined contacts	Standard Black Finish	AC4FPZ AC4FPZB
		2.4 [.094"] 27.0 [1.063"] 36.8 [1.449"] 22.2 [.874"] 25.5 [1.006"] 32.1 [1.265"]	XLR 5 pole male, Narrow flange, Machined contacts	Standard Black Finish	AC5MPNZ AC5MPNZB
		27.2 [1.070"] 2.4 [.094"] 26.4 [1.039"] 36.7 [1.445"] 16.7 [.656"] 31.5 [1.238"]	XLR 5 pole male, Wide flange, Machined contacts	Standard Black Finish	AC5MP AC5MPB
		27.2 [1.070"] 3.5 [.138"] 26.4 [1.039"] 36.7 [1.445"] 16.7 [.656"] 30.6 [1.204"]	XLR 5 pole female, Wide flange, Machined contacts	Standard Black Finish	AC5FPZ AC5FPZB
		2.4 [.094"] 27.0 [1.063"] 36.8 [1.449"] 22.2 [.874"] 25.5 [1.006"] 32.1 [1.265"]	XLR 6A pole male, Narrow flange, Machined contacts	Standard Black Finish	AC6AMPNZ AC6AMPNZB
		27.2 [1.070"] 2.4 [.094"] 26.4 [1.039"] 36.7 [1.445"] 16.7 [.656"] 31.5 [1.238"]	XLR 6A pole male, Wide flange, Machined contacts	Standard Black Finish	AC6AMP AC6AMPB
		27.2 [1.071"] 3.5 [.138"] 26.2 [1.031"] 36.8 [1.449"] 16.7 [.656"] 31.1 [1.224"]	XLR 6A pole female, Wide flange, Machined contacts	Standard Black Finish	AC6AFPZ AC6AFPZB

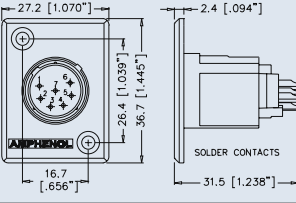

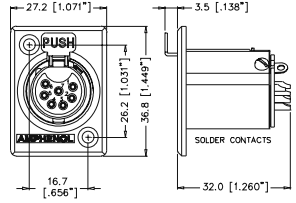
PRODUCT - FIGURE	DRAWING	Dimensions in mm (inches)	DESCRIPTION	VARIATIONS	PART NUMBER
			XLR 7 pole male, Narrow flange, Gold Plated Machined contacts	Standard	AC7MPNZ
				Black Finish	AC7MPNZB
			XLR 7 pole male, Wide flange, Gold Plated Machined contacts	Standard	AC7MP
				Black Finish	AC7MPB
			XLR 7 pole female, Wide flange, Gold Plated Machined contacts	Standard	AC7FPZ
				Black Finish	AC7FPZB



PART NUMBER BREAKDOWN

METAL TYPE FLANGE

E. G. **AC3MMPNZVB-AU BULK**
AC (Series Prefix), **3** contacts, **M**ale, **M**achined Contacts, **PN** (Narrow Flange), **Z** (Metal Chassis Series), **B**lack Polyester Finish, **- AU** (Gold Plated Contacts), **BULK** Packaged.

SERIES PREFIX	AC	=	Series Prefix
CONTACT LAYOUTS	3	=	3 Contacts
	4	=	4 Contacts
	5	=	5 Contacts
	6A	=	6 Contacts
	7	=	7 Contacts
GENDER	F	=	Female Socket Contacts
	M	=	Male Pin Contacts
MACHINED CONTACTS¹	Blank	=	Stamped Contacts
	M	=	Machined Contacts (Applicable 3 male pin contacts only)
SHELL STYLE	D	=	Small Flange (front or rear mounting)
	P	=	Large Shell with Wide Flange
	PN	=	Large Shell with Narrow Flange (male only)
SHELL SERIES	Blank	=	Male P Shell Style Only
	Z	=	Metal Chassis Series
SHELL FINISH²	Blank	=	Nickel Plated Finish
	B	=	Black Polyester Finish
CONTACT PLATING³	Blank	=	Standard Plating (Silver or Tin - refer to Standard Data)
	AU	=	Gold Plated
PACKAGING	Blank	=	Individual Bags
	BULK	=	Bulk Packed

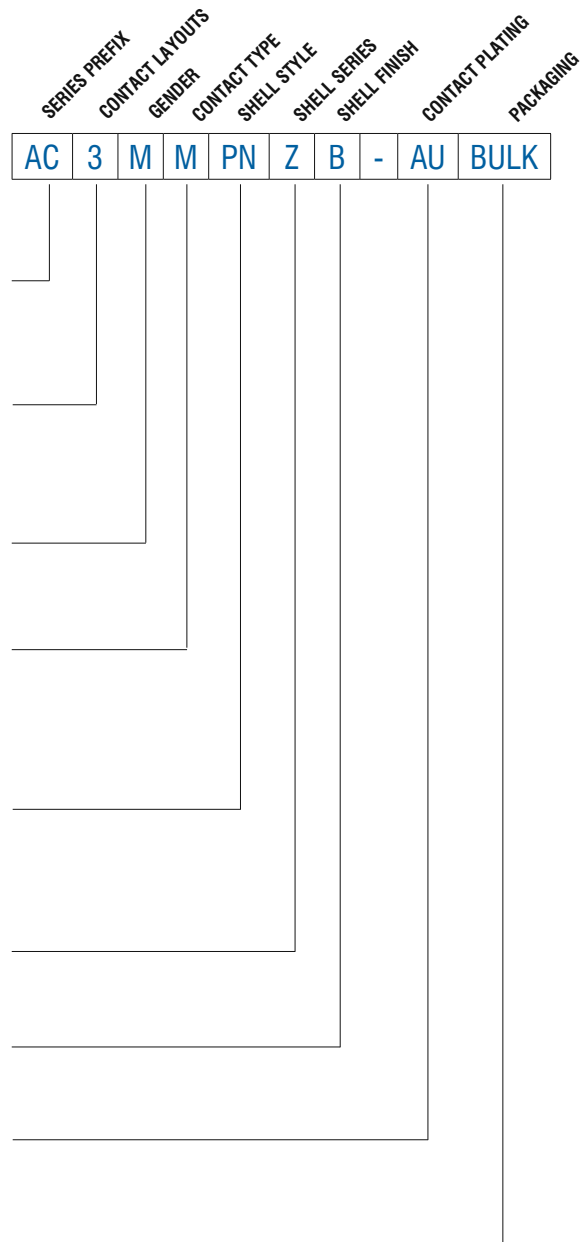

Note:

¹ 4 - 7 contact connectors have machined contacts and grounding as standard. They are not available in stamped contacts.

² Ground contacts are not supplied with the black polyester finish shell option.

³ 7 Contact is gold plated as standard.

⁴ Non-Latching Versions (Female) available - Please contact us for part number options.

STANDARD DATA AC SERIES CHASSIS - METAL "Z"

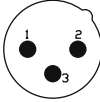
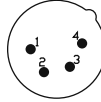
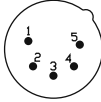
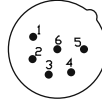
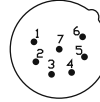
		VALUE				
GENERAL CHARACTERISTICS	Number of contacts	3	4	5	6A	7
	Contact Arrangement (Front view of pin inserts)					
	Termination	Solder Bucket / Printed Circuit Board (PCB)				
	Max. Wire Gauge - Stranded wire:					
	Solder	14AWG	16AWG	18AWG	18AWG	20AWG
	Printed Circuit Board - PCB	N/A	N/A	N/A	N/A	N/A
Flammability rating of plastics	UL94V-0					
Environmental	Complies with EU RoHS 2 Directive 2011/65/EU					
ELECTRICAL CHARACTERISTICS	Service Voltage RMS	133V ¹⁾				
	Test Voltage AC RMS	1400V				
	Current carrying capacity:					
	Solder	15A	10A	7.5A	7.5A	5A
	Printed Circuit Board (PCB)	15A	10A	7.5A	7.5A	5A
	Typical Contact Resistance	≤3mΩ				
Insulation Resistance	≥1000MΩ					
CLIMATIC CHARACTERISTICS	Protection Class	IP40				
	Operating Temperature	-25 °C to +75 °C (-13°F to +167°F)				
MECHANICAL CHARACTERISTICS	Weight - Metal ²⁾	31g (0.068lb)	32g (0.070lb)	33g (0.072lb)	33g (0.072lb)	33g (0.072lb)
	Mechanical Operations	1000 mating cycles				
MATERIALS	Connector Shell	Diecast Zinc Alloy				
	Shell Finish	Satin Nickel or Black Polyester				
	Insulators	UL94V-0 PBT Resin or Modified PPE Resin				
	Male Contact					
	Stamped Solder and PCB-(Material/Plating)	Phosphor Bronze / Silver or Gold (optional)				
	Machined Solder-(Material/Plating)	Brass / Silver or Gold (optional)				
	Female Contact					
Stamped Solder and PCB-(Material/Plating)	Phosphor Bronze / Tin or Gold (optional)					
Machined Solder-(Material/Plating)	Brass / Silver or Gold (Optional)					

Rev 3 - 03/2013

¹⁾ Not suitable for domestic applications above 50V

²⁾ Approximate weight only, does not include packaging. Please contact us for exact weight for shipping purposes.

AC SERIES CHASSIS METAL "Z"

PCB FOOTPRINTS STRAIGHT (V)

CONNECTOR SIDE OF PCB

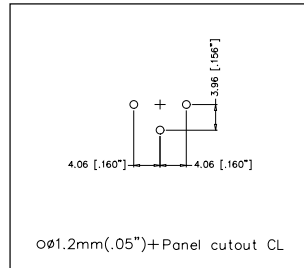

AC3MM*ZV

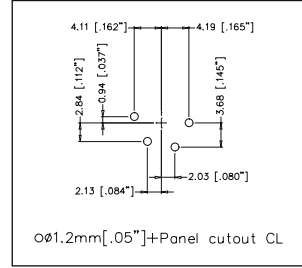

AC4F*ZV

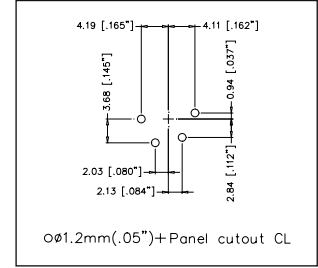

AC4M*ZV

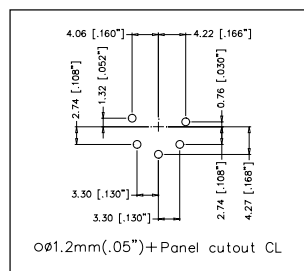

AC5F*ZV

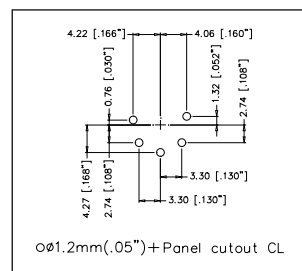

AC5M*ZV

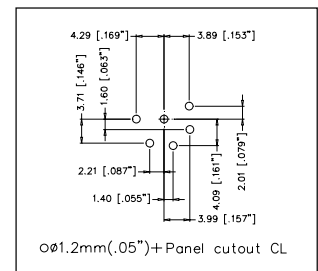

AC6AF*ZV

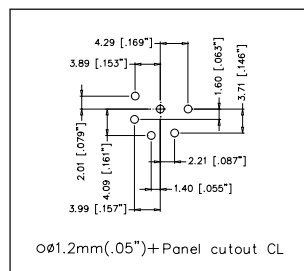

AC6AM*ZV

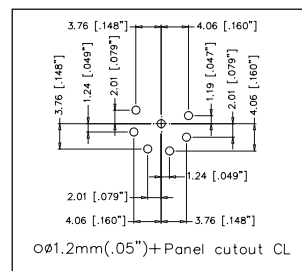

AC7F*ZV

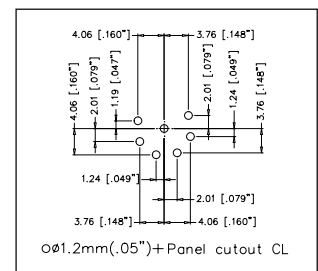

AC7M*ZV

PANEL CUTOUT DIMENSIONS

FRONT VIEW

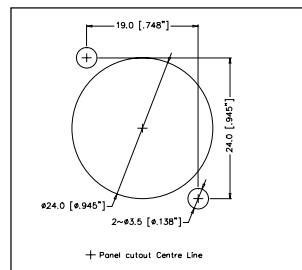

AC*FDZ

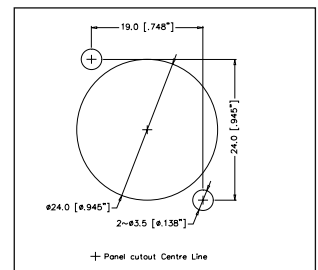

AC*MDZ

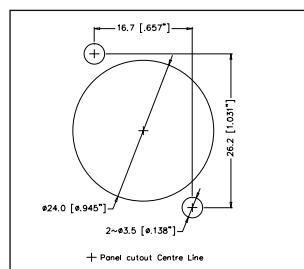

AC*FPZ

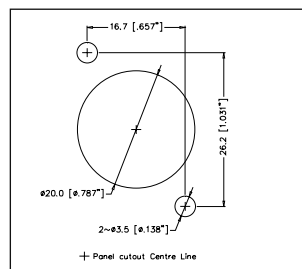

AC*MP

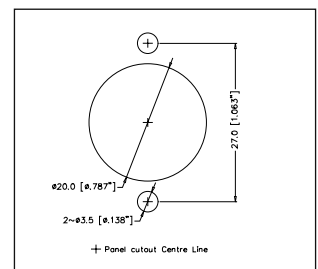

AC*MPNZ



AC SERIES XLR PCB CHASSIS MOUNT CONNECTORS



The AC series, A and B type XLR chassis receptacles have been designed and manufactured with the Original Equipment Manufacturers' (OEM) needs in mind. The compact shell design allows a significant space saving over the traditional 'D' type shell. Gold plated contacts improve the performance, ensuring a reliable contact and the unique grounding link options offer flexibility in design.

Features

- A leading first mate last break socket contact is standard on all female connectors (Pin 1).
- Vertical and Horizontal PCB versions available.
- Latching and Non-latching versions available.
- A range of different grounding options are available including:
 - Mating connector shell to Pin 1
 - Mating connector shell to Chassis
 - Mating connector shell to pin 1 to Chassis
- A type is available in 3 or 5 contacts.
- B type is available in 3 contact only.
- Compatible with all other XLR brands.
- Metal Mounting Flange (B type)

Options

- Vertical PCB contacts
- Horizontal PCB contacts
- Precision Machined Pin contacts
- Cost effective Stamped Socket contacts
- Gold Plated contacts (Standard)
- Silver Plated contacts (Optional)
- Bulk Packaging
- Integrated Switch

Ordering Codes

We have listed the more common ordering codes in each section. For further options please refer to the part number breakdown charts. Please contact us if you need any further assistance.

Simple steps to guide you in using this catalogue

- 1) Identify the product group listed in Contents on page 1 and go directly to that page number.
- 2) Each product group cover page then details information and options available.
- 3) Refer to the product detail pages and identify the product you require pictorially.
- 4) Read the product description column for the products standard features.
- 5) Use variations column to determine your choice.
- 6) Identify part number.
- 7) In the event the particular option you require is not listed please refer to the part number breakdown page at the end of each section.
- 8) Please contact us directly if you have any further problems.

Amphenol

AC SERIES CHASSIS CONNECTORS

THERMOPLASTIC A - TYPE FLANGE 3 CONTACT



Features:

- Thermoplastic Shell
- Industry standard PCB footprints.
- Vertical or Horizontal PCB mounting.
- Precision machined pin contacts.
- Gold plated contacts.
- Leading first mate last break socket contact.
- Bulk packed in trays, 100 to a box as standard.
- Positive latch lock system.

Options: Vertical or Horizontal PCB, Various grounding methods, Latching or Non-Latching.

**Part Number Breakdown: Page 37 Specifications: Page 40
PCB Footprints: Page 41 Panel Cutouts: Page 42
Recommended Fastener: Page 132**











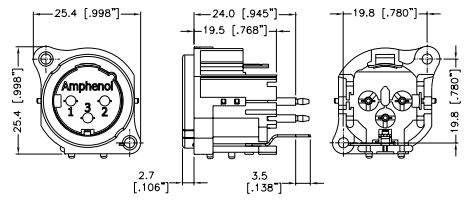

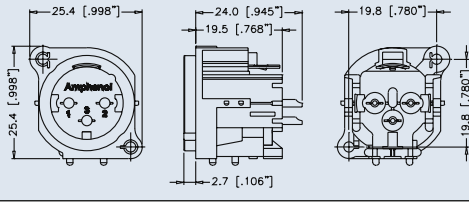

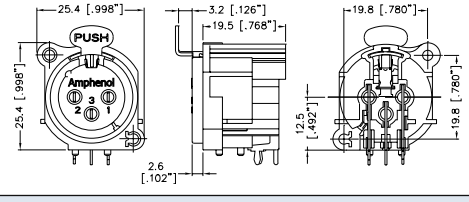

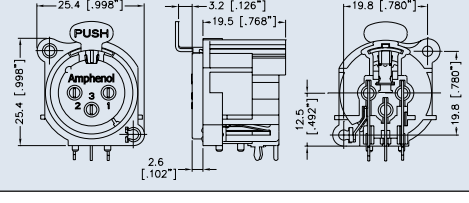

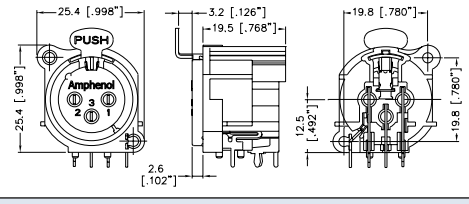

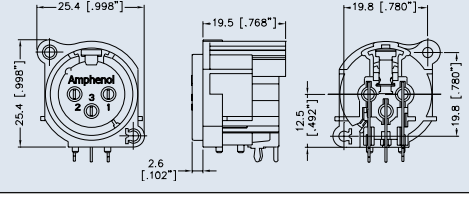

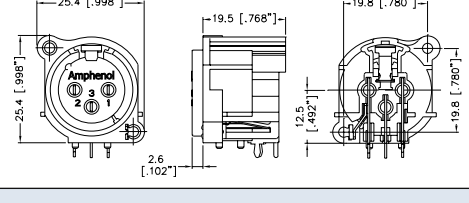

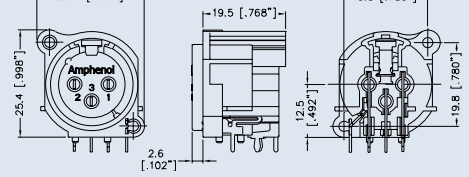

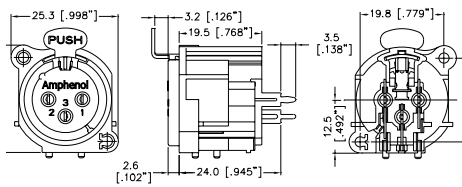

PRODUCT - FIGURE	DRAWING	Dimensions in mm (inches)	DESCRIPTION	GROUND LINK VARIATIONS	PART NUMBER
			XLR 3 pole male, Horizontal PCB, Gold Plated Contacts, Bulk Pack	No Ground Link	AC3MAH-AU-PRE
			XLR 3 pole male, Horizontal PCB, Gold Plated Contacts, Bulk Pack	Pin 1 to Chassis to Mating connector shell	AC3MAH1-AU-PRE
			XLR 3 pole male, Horizontal PCB, Gold Plated Contacts, Bulk Pack	Mating connector shell to Chassis - Pin 1 sep. Ground	AC3MAH2-AU-PRE
			XLR 3 pole male with integrated switch, Horizontal PCB, Gold Plated Contacts, Bulk Pack	Mating connector shell to Chassis to PCB, Pin 1 sep. Ground	AC3MAH4-SW-B
			XLR 3 pole male, Vertical PCB, Gold Plated Contacts, Bulk Pack	No Ground Link	AC3MAV-AU-PRE

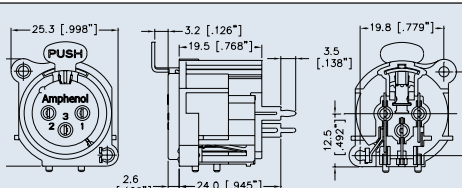
Amphenol

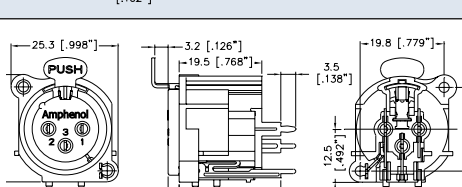
AC SERIES CHASSIS CONNECTORS

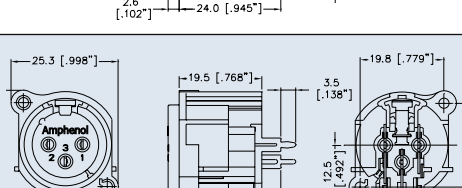
THERMOPLASTIC A TYPE FLANGE

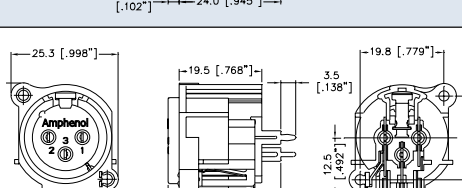
PRODUCT - FIGURE	DRAWING	Dimensions in mm (inches)	DESCRIPTION	GROUND LINK VARIATIONS	PART NUMBER
		25.4 [998] 24.0 [945] 19.5 [768] 19.8 [780] 2.7 [.106] 3.5 [.138]	XLR 3 pole male, Vertical PCB, Gold Plated Contacts, Bulk Pack	Mating connector shell to Chassis - Pin 1 sep. Ground	AC3MAV2-AU-PRE
		25.4 [998] 24.0 [945] 19.5 [768] 19.8 [780] 2.7 [.106]	XLR 3 pole male, Solder Buckets, Gold Plated Contacts, Bulk Pack	No Ground Link	AC3MA-AU-B
		25.4 [998] 3.2 [.126] 19.5 [768] 19.8 [780] 12.5 [.492] 2.6 [.102]	XLR 3 pole female, Horizontal PCB, Latching Type, Gold Plated Contacts, Bulk Pack	No Ground Link	AC3FAH-AU-PRE
		25.4 [998] 3.2 [.126] 19.5 [768] 19.8 [780] 12.5 [.492] 2.6 [.102]	XLR 3 pole female, Horizontal PCB, Latching Type, Gold Plated Contacts, Bulk Pack	Pin 1 to Chassis to Mating connector shell	AC3FAH1-AU-PRE
		25.4 [998] 3.2 [.126] 19.5 [768] 19.8 [780] 12.5 [.492] 2.6 [.102]	XLR 3 pole female, Horizontal PCB, Latching Type, Gold Plated Contacts, Bulk Pack	Mating connector shell to Chassis - Pin 1 sep. Ground	AC3FAH2-AU-PRE
		25.4 [998] 19.5 [768] 19.8 [780] 12.5 [.492] 2.6 [.102]	XLR 3 pole female, Horizontal PCB, Non-Latching Type Gold Plated Contacts, Bulk Pack	No Ground Link	AC3FAHL-AU-PRE
		25.4 [998] 19.5 [768] 19.8 [780] 12.5 [.492] 2.6 [.102]	XLR 3 pole female, Horizontal PCB, Non-Latching Type Gold Plated Contacts, Bulk Pack	Pin 1 to Chassis to mating connector shell	AC3FAHL1-AU-PRE
		25.4 [998] 19.5 [768] 19.8 [780] 12.5 [.492] 2.6 [.102]	XLR 3 pole female, Horizontal PCB, Non-Latching Type Gold Plated Contacts, Bulk Pack	Mating connector shell to Chassis - Pin 1 sep. Ground.	AC3FAHL2-AU-PRE

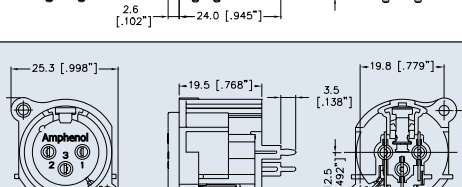
PRODUCT - FIGURE	DRAWING	Dimensions in mm (inches)	DESCRIPTION	GROUND LINK VARIATIONS	PART NUMBER
			XLR 3 pole female, Vertical PCB, Latching Type, Gold Plated Contacts, Bulk Pack	No Ground Link	AC3FAV-AU-PRE
			XLR 3 pole female, Vertical PCB, Latching Type, Gold Plated Contacts, Bulk Pack	Pin 1 to Chassis to Mating connector shell	AC3FAV1-AU-PRE
			XLR 3 pole female, Vertical PCB, Latching Type, Gold Plated Contacts, Bulk Pack	Mating connector shell to Chassis - Pin 1 sep. Ground.	AC3FAV2-AU-PRE
			XLR 3 pole female, Vertical PCB, Non-Latching Type, Gold Plated Contacts, Bulk Pack	No Ground Link	AC3FAVL-AU-PRE
			XLR 3 pole female, Vertical PCB, Non-Latching Type, Gold Plated Contacts, Bulk Pack	Pin 1 to Chassis to Mating connector shell	AC3FAVL1-AU-PRE
			XLR 3 pole female, Vertical PCB, Non-Latching Type, Gold Plated Contacts, Bulk Pack	Mating connector shell to Chassis - Pin 1 sep. Ground.	AC3FAVL2-AU-PRE





Features:

- Thermoplastic Shell with Metal Mounting Flange.
- Industry standard PCB footprints.
- Improved grounding performance.
- Vertical or Horizontal PCB mounting.
- Precision machined pin contacts.
- Gold plated contacts.
- Leading first mate last break socket contact.
- Bulk packed in trays, 100 to a box as standard.
- Positive latch lock system.

Options: Silver plated contacts, Vertical or Horizontal PCB, Various grounding methods, Latching or Non-Latching.

Part Number Breakdown: Page 37 Specifications: Page 40
PCB Footprints: Page 41 Panel Cutouts: Page 42
Recommended Fastener: Page 132

PRODUCT - FIGURE	DRAWING	Dimensions in mm (inches)	DESCRIPTION/ GROUND LINK	MOUNTING FLANGE VARIATIONS	PART NUMBER
		25.3 [.996"] 19.5 [.768"] 19.8 [.780"] 25.3 [.996"] 2.7 [.106"] 3.5 [.139"] 12.5 [.492"] 19.8 [.780"]	XLR 3 pole male, Horizontal PCB, Gold Plated Contacts, Bulk Pack No Ground Link	Nickel Finish	AC3MBH-AU-B
		25.3 [.996"] 19.5 [.768"] 19.8 [.780"] 25.3 [.996"] 2.7 [.106"] 3.5 [.139"] 12.7 [.500"] 19.8 [.780"]	XLR 3 pole male, Horizontal PCB, Gold Plated Contacts, Bulk Pack Pin 1 to Chassis to Mating connector shell	Nickel Finish	AC3MBH1-AU-B
		25.3 [.996"] 19.5 [.768"] 19.8 [.780"] 25.3 [.996"] 2.7 [.106"] 3.5 [.139"] 12.5 [.492"] 19.8 [.780"]	XLR 3 pole male, Horizontal PCB, Gold Plated Contacts, Bulk Pack Mating connector shell to Chassis - Pin 1 sep. Ground	Nickel Finish	AC3MBH2-AU-B
		25.3 [.996"] 19.5 [.768"] 19.8 [.780"] 25.3 [.996"] 2.7 [.106"] 3.5 [.139"] 12.5 [.492"] 19.8 [.780"]	XLR 3 pole male, Horizontal PCB, Gold Plated Contacts, Bulk Pack Mating connector shell to Pin 1	Nickel Finish	AC3MBH3-AU-B
		25.3 [.996"] 19.5 [.768"] 19.8 [.780"] 25.3 [.996"] 2.7 [.106"] 3.5 [.139"] 12.5 [.492"] 19.8 [.780"]	XLR 3 pole male, Horizontal PCB, Non-Latching Type, Gold Plated Contacts, Bulk Pack No Ground Link	Nickel Finish	AC3MBHL-AU-B
		25.3 [.996"] 19.5 [.768"] 19.8 [.780"] 25.3 [.996"] 2.7 [.106"] 3.5 [.139"] 12.5 [.492"] 19.8 [.780"] 24.0 [.945"]	XLR 3 pole male, Vertical PCB, Gold Plated Contacts, Bulk Pack No Ground Link	Nickel Finish	AC3MBV-AU-B





METAL B TYPE FLANGE

PRODUCT - FIGURE	DRAWING	Dimensions in mm (inches)	DESCRIPTION/ GROUND LINK	MOUNTING FLANGE VARIATIONS	PART NUMBER
			XLR 3 pole male, Vertical PCB, Gold Plated Contacts, Bulk Pack Pin 1 to Chassis to Mating connector shell	Nickel Finish	AC3MBV1-AU-B
			XLR 3 pole male, Vertical PCB, Gold Plated Contacts, Bulk Pack Mating connector shell to Chassis - Pin 1 sep. Ground	Nickel Finish	AC3MBV2-AU-B
			XLR 3 pole male, Vertical PCB, Gold Plated Contacts, Bulk Pack Mating connector shell to Pin 1	Nickel Finish	AC3MBV3-AU-B
			XLR 3 pole female, Horizontal PCB, Latching Type, Gold Plated Contacts, Bulk Pack No Ground Link	Nickel Finish	AC3FBH-AU-B
			XLR 3 pole female, Horizontal PCB, Latching Type, Gold Plated Contacts, Bulk Pack Pin 1 to Chassis to Mating connector shell	Nickel Finish	AC3FBH1-AU-B
			XLR 3 pole female, Horizontal PCB, Latching Type, Gold Plated Contacts, Bulk Pack Mating connector shell to Chassis - Pin 1 sep. Ground	Nickel Finish	AC3FBH2-AU-B
			XLR 3 pole female, Horizontal PCB, Latching Type, Gold Plated Contacts, Bulk Pack Pin 1 to Chassis	Nickel Finish	AC3FBH3-AU-B
			XLR 3 pole female, Horizontal PCB, Non-Latching Type Gold Plated Contacts, Bulk Pack No Ground Link	Nickel Finish	AC3FBHL-AU-B

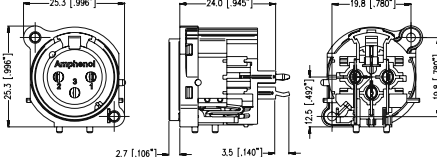

PRODUCT - FIGURE	DRAWING	Dimensions in mm (inches)	DESCRIPTION/ GROUND LINK	MOUNTING FLANGE VARIATIONS	PART NUMBER
			XLR 3 pole female, Horizontal PCB, Non-Latching Type Gold Plated Contacts, Bulk Pack Pin 1 to Chassis to mating connector shell	Nickel Finish	AC3FBHL1-AU-B
			XLR 3 pole female, Horizontal PCB, Non- Latching Type, Gold Plated Contacts, Bulk Pack Mating connector shell to Chassis - Pin 1 sep. Ground.	Nickel Finish	AC3FBHL2-AU-B
			XLR 3 pole female, Horizontal PCB, Non-Latching Type Gold Plated Contacts, Bulk Pack Pin 1 to Chassis	Nickel Finish	AC3FBHL3-AU-B
			XLR 3 pole female, Vertical PCB, Latching Type, Gold Plated Contacts, Bulk Pack No Ground Link	Nickel Finish	AC3FBV-AU-B
			XLR 3 pole female, Vertical PCB, Latching Type, Gold Plated Contacts, Bulk Pack Pin 1 to Chassis to mating connector shell	Nickel Finish	AC3FBV1-AU-B
			XLR 3 pole female, Vertical PCB, Latching Type, Gold Plated Contacts, Bulk Pack Mating connector shell to Chassis - Pin 1 sep. Ground.	Nickel Finish	AC3FBV2-AU-B
			XLR 3 pole female, Vertical PCB, Latching Type, Gold Plated Contacts, Bulk Pack Pin 1 to Chassis	Nickel Finish	AC3FBV3-AU-B
			XLR 3 pole female, Vertical PCB, Non-Latching Type, Gold Plated Contacts, Bulk Pack No Ground Link	Nickel Finish	AC3FBVL-AU-B

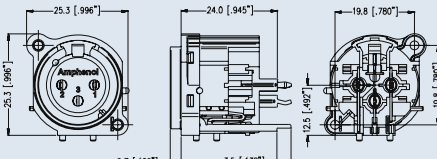

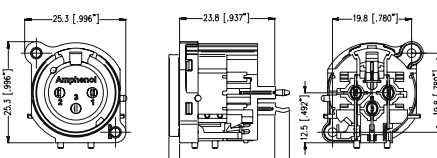
PRODUCT - FIGURE	DRAWING	DESCRIPTION/ GROUND LINK	MOUNTING FLANGE VARIATIONS	PART NUMBER
	 <p>Dimensions in mm (inches)</p>	<p>XLR 3 pole female, Vertical PCB, Non-Latching Type, Gold Plated Contacts, Bulk Pack</p> <p>Pin 1 to Chassis to Mating connector shell</p>	Nickel Finish	AC3FBVL1-AU-B
	 <p>Dimensions in mm (inches)</p>	<p>XLR 3 pole female, Vertical PCB, Non-Latching Type, Gold Plated Contacts, Bulk Pack</p> <p>Mating connector shell to Chassis-Pin 1 sep. Ground.</p>	Nickel Finish	AC3FBVL2-AU-B
	 <p>Dimensions in mm (inches)</p>	<p>XLR 3 pole female, Vertical PCB, Non-Latching Type, Gold Plated Contacts, Bulk Pack</p> <p>Pin 1 to Chassis</p>	Nickel Finish	AC3FBVL3-AU-B



THERMOPLASTIC A - TYPE FLANGE 5 CONTACT







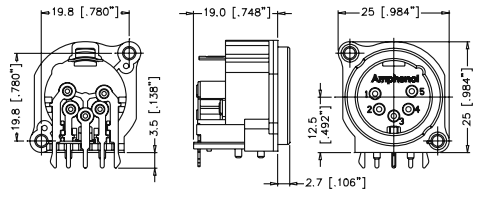

Features:

- 5 contacts.
- Thermoplastic Shell
- Industry standard PCB footprints.
- Vertical or Horizontal PCB mounting.
- Precision machined pin contacts.
- Gold plated contacts.
- Leading first mate last break socket contact.
- Bulk packed in trays, 100 to a box as standard.
- Positive latch lock system.

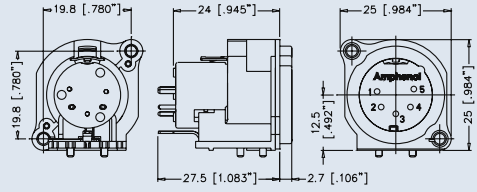
Options: Vertical or Horizontal PCB,

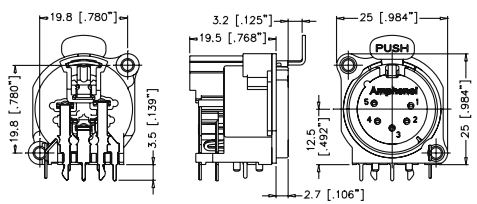
Part Number Breakdown: Page 39 **Specifications:** Page 40
PCB Footprints: Page 41 **Panel Cutouts:** Page 42
Recommended Fastener: Page 132

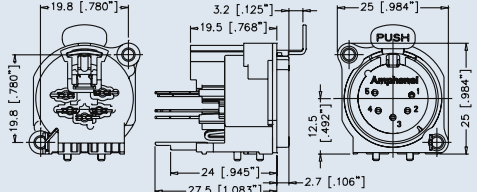
PRODUCT - FIGURE	DRAWING	Dimensions in mm (inches)	DESCRIPTION/ GROUND LINK	MOUNTING FLANGE VARIATIONS	PART NUMBER
			XLR 5 pole male, Horizontal PCB, Gold Plated Contacts, Bulk Pack	Mating connector shell to Chassis to PCB, Pin 1 sep. Ground	AC5MAH-AU-B
			XLR 5 pole male, Verti- cal PCB, Gold Plated Contacts, Bulk Pack	Mating connector shell to Chassis to PCB, Pin 1 sep. Ground	AC5MAV-AU-B
			XLR 5 pole female, Horizontal PCB, Gold Plated Contacts, Bulk Pack	Mating connector shell to Chassis to PCB, Pin 1 sep. Ground	AC5FAH-AU-B
			XLR 5 pole female, Vertical PCB, Gold Plated Contacts, Bulk Pack	Mating connector shell to Chassis to PCB, Pin 1 sep. Ground	AC5FAV-AU-B

PART NUMBER BREAKDOWN

AC SERIES A AND B TYPE MALE - 3 CONTACT

E. G. **AC3MAVL3-AU B**
AC (series prefix), **3** contacts, **M**ale, **A** Type, **V**ertical Printed Circuit Board, **L**atchless, **3** (Mating Shell to Pin 1 Grounding), **- AU** (Gold Plated Contacts), **B**ulk Packaged.

SERIES PREFIX	AC	=	Series Prefix
CONTACT LAYOUT	3	=	3 Contact only
GENDER	M	=	Male Socket Contacts
SHELL SERIES	A	=	A Type
	B	=	B Type
TERMINATION	H	=	Horizontal Printed Circuit Board
	V	=	Vertical Printed Circuit Board
	Blank	=	Solder Bucket Contacts
MOUNTING FLANGE FINISH (B TYPE ONLY)	Blank	=	Nickel
LOCKING MECHANISM	Blank	=	Latching
	L	=	Latchless
GROUNDING LINK OPTIONS	Blank	=	No Ground Link
	1	=	Pin 1 to Chassis to mating connector shell
	2	=	Mating Connector shell to Chassis, Pin 1 to separate ground
	3	=	Mating connector to Pin 1
CONTACT PLATING	AU	=	Gold Plated Contacts
	AG	=	Silver Plated Contacts (Non-Standard)
PACKAGING	B	=	Bulk Packed

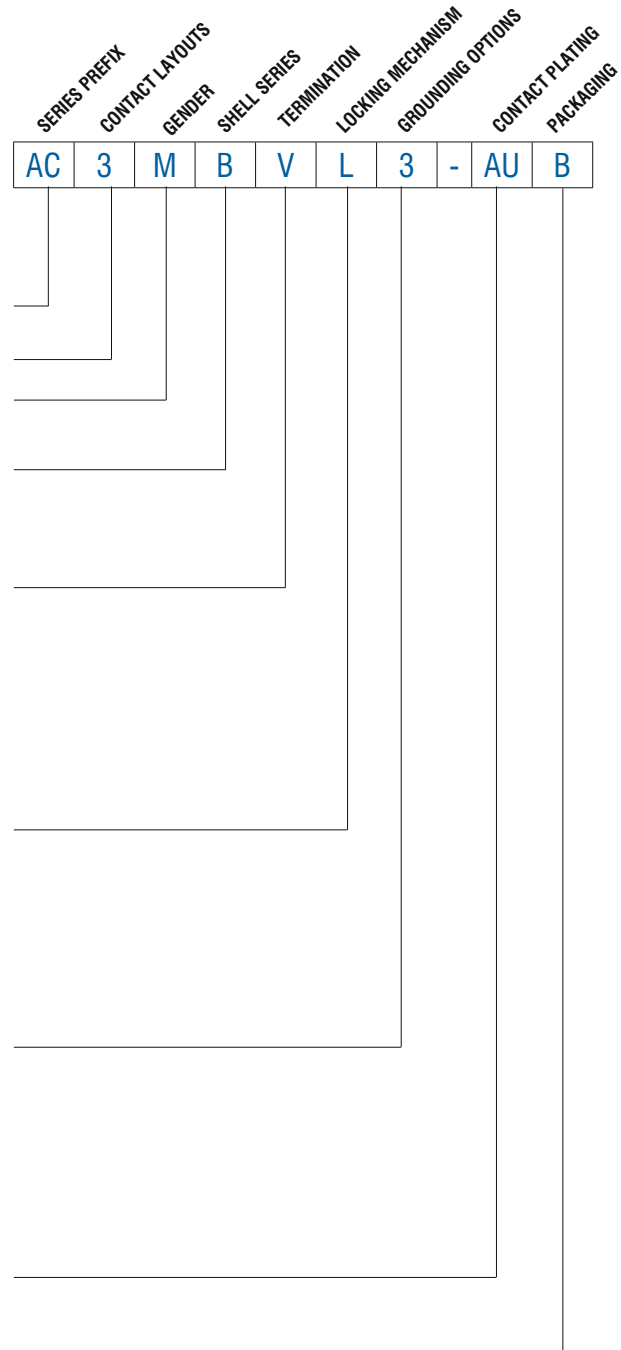

PART NUMBER BREAKDOWN

AC SERIES A AND B TYPE FEMALE - 3 CONTACT



E. G. **AC3MAVL3-AU B**
AC (series prefix), **3** contacts, **F**emale, **A** Type, **V**ertical Printed Circuit Board, **L**atchless, **3** (Pin 1 to Chassis Grounding), **- AU** (Gold Plated Contacts), **B**ulk Packaged.

SERIES PREFIX	AC	=	Series Prefix
CONTACT LAYOUT	3	=	3 Contact only
GENDER	F	=	Female Socket Contacts
SHELL SERIES	A	=	A Type
	B	=	B Type
TERMINATION	H	=	Horizontal Printed Circuit Board
	V	=	Vertical Printed Circuit Board
LOCKING MECHANISM	Blank	=	Latching
	L	=	Latchless
GROUNDING LINK OPTIONS	Blank	=	No Ground Link
	1	=	Pin 1 to Chassis to mating connector shell
	2	=	Mating Connector shell to Chassis, Pin 1 to separate ground
	3	=	Pin 1 to Chassis
CONTACT PLATING	AU	=	Gold Plated Contacts
	AG	=	Silver Plated Contacts (Non-Standard)
PACKAGING	B	=	Bulk Packed

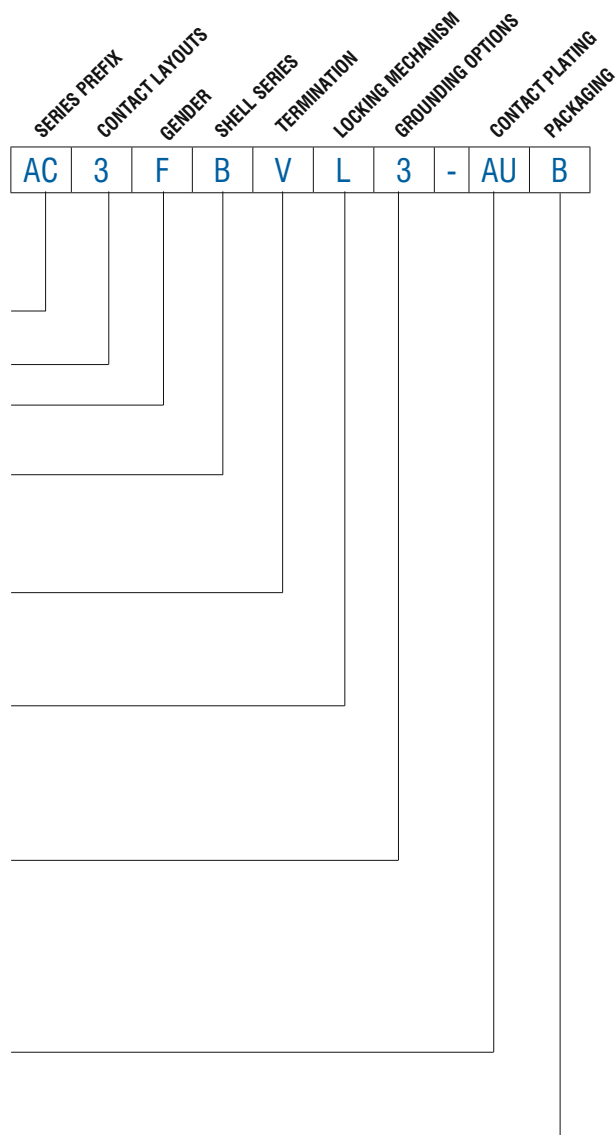

PART NUMBER BREAKDOWN



AC SERIES A TYPE MALE AND FEMALE - 5 CONTACT

E. G. **AC5FAV-AU-B**
AC (series prefix), **5** contacts, **F**emale, **A** Type, **V**ertical Printed Circuit Board, **AU**
 (Gold Plated Contacts) - **B**ulk Packaged.

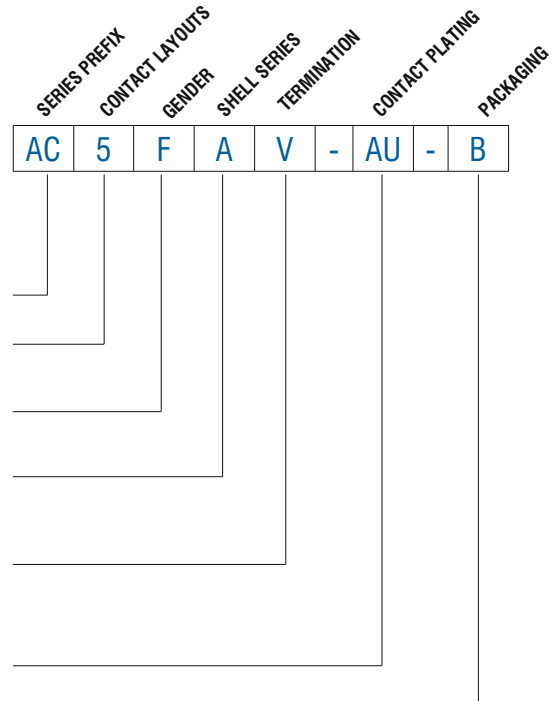
SERIES PREFIX	AC	=	Series Prefix
CONTACT LAYOUT	5	=	5 Contact only
GENDER	F	=	Female Socket Contacts
	M	=	Male Pin Contacts
SHELL SERIES	A	=	A Type
TERMINATION	H	=	Horizontal Printed Circuit Board
	V	=	Vertical Printed Circuit Board
CONTACT PLATING	AU	=	Gold Plated Contacts
PACKAGING	B	=	Bulk Packed



STANDARD DATA AC SERIES A AND B TYPE CHASSIS

		VALUE	
GENERAL CHARACTERISTICS	Number of contacts	3	5
	Contact Arrangements (Front view of pin insert)		
	Termination	Printed Circuit Board (PCB)	
	Flammability rating of plastics	UL94V-0	
	Environmental	Complies with EU RoHS 2 Directive 2011/65/EU	
ELECTRICAL CHARACTERISTICS	Service Voltage RMS	133V ¹⁾	
	Test Voltage AC RMS	1500V	
	Current carrying capacity	6A	3A
	Typical Contact Resistance	≤5mΩ	
	Insulation Resistance (initial)	≥2GΩ	
	Insulation Resistance (after damp heat test)	≥1GΩ	
CLIMATIC CHARACTERISTICS	Protection Class	IP40	
	Operating Temperature	-25 °C to +75 °C (-13°F to +167°F)	
MECHANICAL CHARACTERISTICS	Weight ²⁾	14g (0.030lb)	
	Retention Spring separating force	≥20N	
	Mounting Screw torque max.	1.5Nm	
	Mechanical Operations	1500 mating cycles	
	Fastening A Type Connectors ³⁾ Fastening B Type Connectors ³⁾	Self-Tapping PT screw with thread 2.9 x 1.06 and of Tri-rondular configuration Self-Tapping screw M2.5	
MATERIALS	Connector Flange - B-Type Flange Finish - B-Type	Diecast Zinc Alloy Nickel	
	Insulators	PA6.6+25% glass fibre reinforced, UL94V-0	
	Male Contact Material Male Contact Plating	Brass 0.05μm gold over 2μm nickel	
	Female Contact Material Female Contact Plating	Bronze 0.05μm gold over 2μm nickel	
	Latch lock and Spring	Spring Steel	
	Ground element	Spring Steel	

¹ Not suitable for domestic applications above 50V

² Approximate weight only, does not include packaging. Please contact us for exact weight for shipping purposes.

³ Refer to page 132

AC SERIES A AND B TYPE CHASSIS PCB FOOTPRINTS STRAIGHT (V) - CONNECTOR SIDE OF PCB

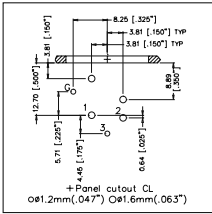

AC3FAH2
AC3FBH2

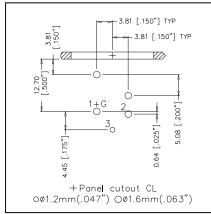

AC3FAH1
AC3FAH3
AC3FBH1
AC3FBH3
AC3FAH
AC3FBH

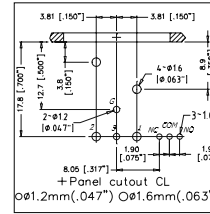

AC3MAH4SWB

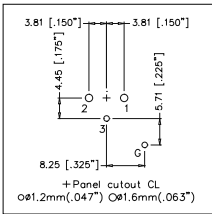

AC3FAV2
AC3FBV2

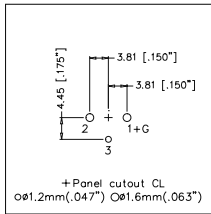

AC3FAV1
AC3FAV3
AC3FBV1
AC3FBV3
AC3FAV
AC3FBV

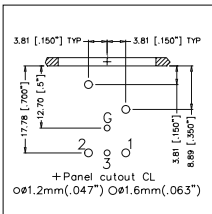

AC3MAH2
AC3MAH4
AC3MBH2

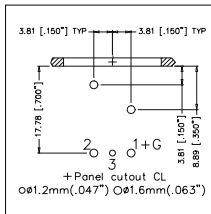

AC3MAH1
AC3MAH3
AC3MBH1
AC3MBH3
AC3MAH
AC3MBH
AC3MBHL

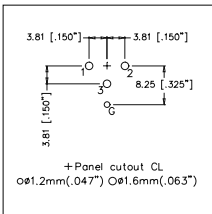

AC3MAV2
AC3MAV4
AC3MBV2

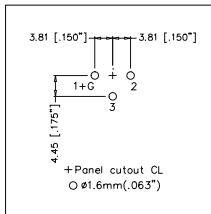

AC3MAV1
AC3MAV3
AC3MBV1
AC3MBV3
AC3MAV
AC3MBV

AC SERIES 5 PIN PCB FOOTPRINTS STRAIGHT (V) - CONNECTOR SIDE OF PCB

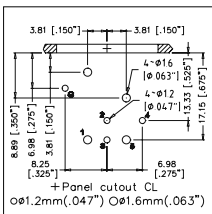

AC5FAH

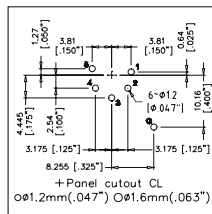

AC5FAV

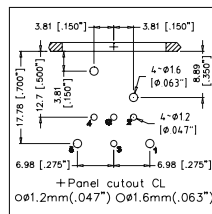

AC5MAH

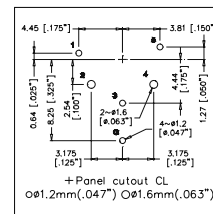

AC5MAV



AC SERIES A AND B TYPE CHASSIS

PANEL CUTOUT DIMENSIONS - FRONT VIEW

A TYPE

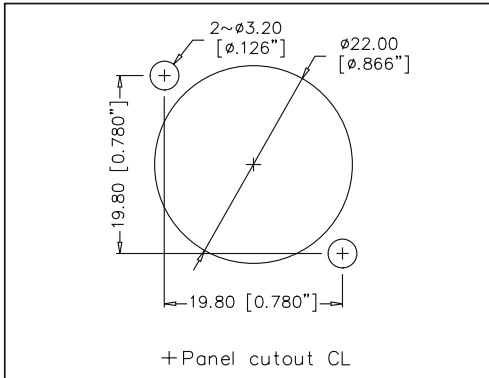

B TYPE

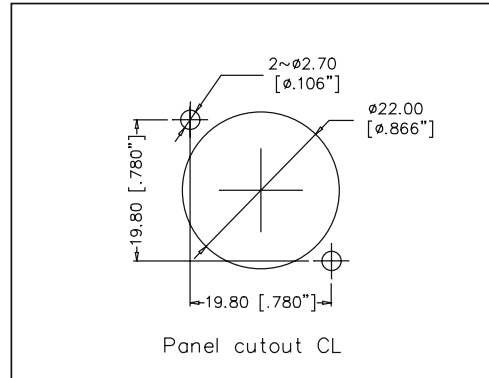

**A AND B
TYPE MALE
MOUNTING
PITCH**

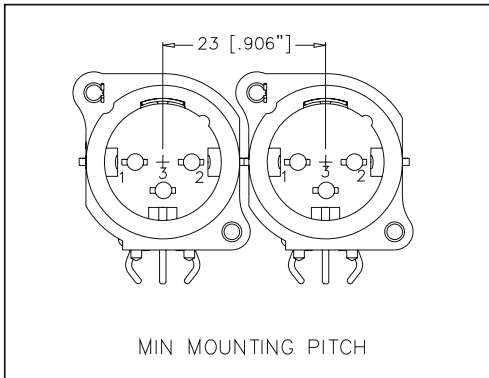

**A AND
B TYPE
FEMALE
MOUNTING
PITCH**

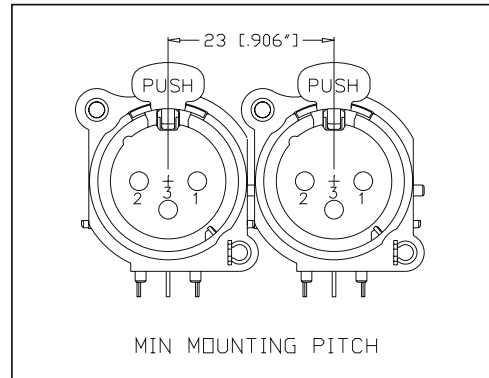

AC3FA/BH/V SCHEMATIC CHART

AC3FA/BH/V3-AU
AC3FA/BH/VL3-AU

AC3FA/BH/V2-AU
AC3FA/BH/VL2-AU

AC3FA/BH/V1-AU
AC3FA/BH/VL1-AU

AC3FA/BH/V-AU
AC3FA/BH/VL-AU

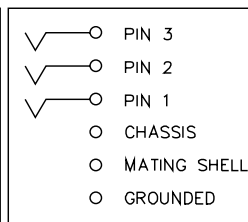
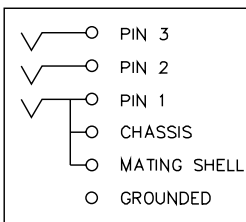
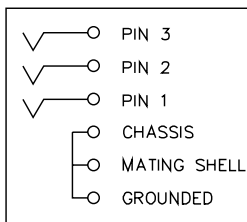
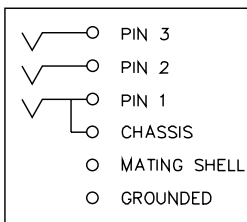

AC3MA/BH/V3-AU
AC3MA/BH/VL3-AU

AC3MA/BH/V2/4-AU
AC3MA/BH/VL2/4-AU

AC3MA/BH/V1-AU
AC3MA/BH/VL1-AU

AC3MA/BH/V-AU
AC3MA/BH/VL-AU

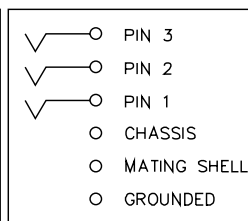
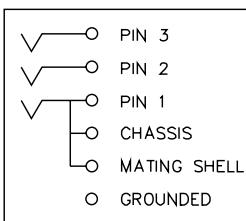
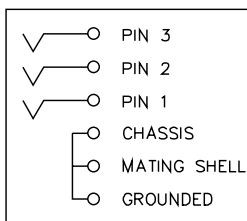
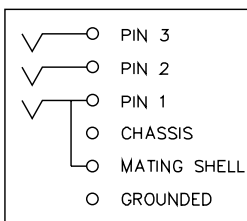



AC SERIES DUAL 1/4" (6.35mm) / XLR



The AC Series C type chassis receptacles feature two connectors in the one space saving housing. A combined XLR female receptacle together with a 6.35mm (1/4") phone jack give the designer more flexibility ensuring premium board space is saved. The new low profile high density C type offers a 15% space saving over the traditional C type. Various configurations are available in either stereo or mono layouts with Vertical, Horizontal Printed Circuit Board or Solder contacts.

Ordering Codes

We have listed the more common ordering codes in each section. For further options please refer to the part number breakdown charts. Please contact us if you need any further assistance.

Simple steps to guide you in using this catalogue

- 1) Identify the product group listed in Contents on page 1 and go directly to that page number.
- 2) Each product group cover page then details information and options available.
- 3) Refer to the product detail pages and identify the product you require pictorially.
- 4) Read the product description column for the products standard features.
- 5) Use variations column to determine your choice.
- 6) Identify part number.
- 7) In the event the particular option you require is not listed please refer to the part number breakdown page at the end of each section.
- 8) Please contact us directly if you have any further problems.

Features

- Standard or low profile / high density shell design
- Two connectors in the one housing.
- Industry standard PCB footprint layout on standard C type.
- Vertical or Horizontal PCB mounting.
- Bulk packed.
- Positive latch lock system (XLR).

Options

- Solder contacts
- Vertical PCB contacts
- Horizontal PCB contacts
- Bulk Packaging
- Overmoldable connector housing

Amphenol

AC SERIES CHASSIS CONNECTORS

C - TYPE LOW PROFILE DUAL JACK / XLR CONNECTORS











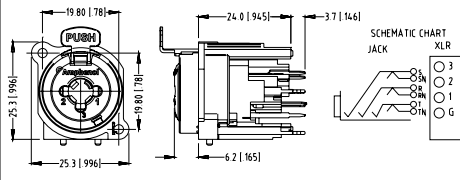

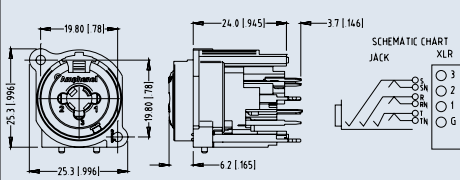
Features:

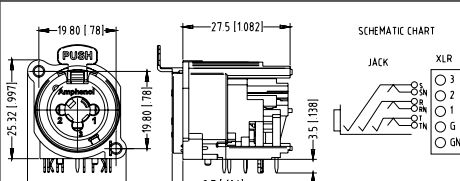
- Two connectors in the one housing.
- Low profile design offers a 15% space saving over the traditional design.
- Vertical or Horizontal PCB mounting.
- Bulk packed in trays, 100 to a box as standard.
- Positive latch lock system (XLR).

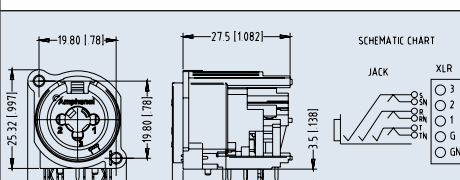
Part Number Breakdown: Page 49
Specifications: Page 51
PCB Footprints: Page 50
Recommended Fastener: Page 132

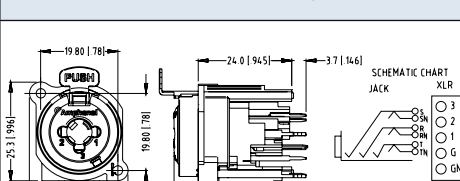
PRODUCT - FIGURE	DRAWING	Dimensions in mm (inches)	DESCRIPTION	VARIATIONS	PART NUMBER
			Low Profile XLR 3 pole female receptacle with 1/4" stereo jack without switching contact, Horizontal PCB mount, Bulk Pack	Latching	ACJC6AH BULK
			Low Profile XLR 3 pole female receptacle with 1/4" stereo jack without switching contact, Horizontal PCB mount, Bulk Pack	Non-latching, Retention Spring	ACJC6AHL BULK
			Low Profile XLR 3 pole female receptacle with 1/4" stereo jack without switching contact, Vertical PCB mount, Bulk Pack	Latching	ACJC6AV2 BULK
			Low Profile XLR 3 pole female receptacle with 1/4" stereo jack without switching contact, Vertical PCB mount, Bulk Pack	Non-latching, Retention Spring	ACJC6AV2L BULK
			Low Profile XLR 3 pole female receptacle with 1/4" switching stereo jack, Horizontal PCB mount, Bulk Pack	Latching	ACJC9AH BULK
			Low Profile XLR 3 pole female receptacle with 1/4" switching stereo jack, Horizontal PCB mount, Bulk Pack	Non-latching, Retention Spring	ACJC9AHL BULK

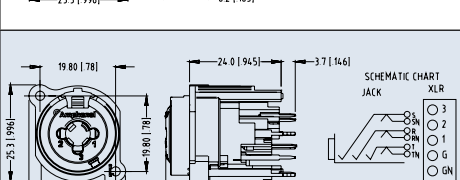
PRODUCT - FIGURE	DRAWING	Dimensions in mm (inches)	DESCRIPTION	VARIATIONS	PART NUMBER
			Low Profile XLR 3 pole female receptacle with 1/4" switching stereo jack, Vertical PCB mount, Bulk Pack	Latching	ACJC9AV2 BULK
			Low Profile XLR 3 pole female receptacle with 1/4" switching stereo jack, Vertical PCB mount, Bulk Pack	Non-latching, Retention Spring	ACJC9AV2L BULK
			Low Profile XLR 3 pole female receptacle with 1/4" switching stereo jack and switching ground contact, Horizontal PCB mount, Bulk Pack	Latching	ACJC10AH BULK
			Low Profile XLR 3 pole female receptacle with 1/4" switching stereo jack and switching ground contact, Horizontal PCB mount, Bulk Pack	Non-latching, Retention Spring	ACJC10AHL BULK
			Low Profile XLR 3 pole female receptacle with 1/4" switching stereo jack and switching ground contact, Vertical PCB mount, Bulk Pack	Latching	ACJC10AV2 BULK
			Low Profile XLR 3 pole female receptacle with 1/4" switching stereo jack and switching ground contact, Vertical PCB mount, Bulk Pack	Non-latching, Retention Spring	ACJC10AV2L BULK



C - TYPE DUAL JACK / XLR CONNECTORS

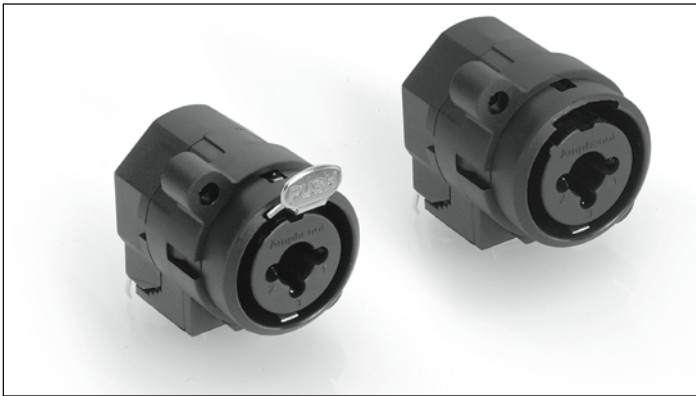

Features:

- Two connectors in the one housing.
- Space saving design.
- Industry standard PCB footprint layout.
- Vertical or Horizontal PCB mounting.
- Bulk packed in trays, 100 to a box as standard.
- Positive latch lock system (XLR).











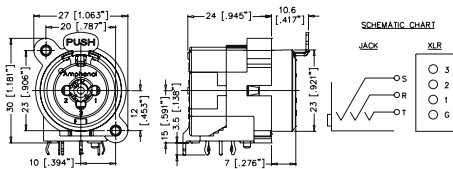

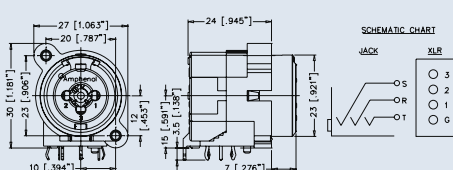
Part Number Breakdown: Page 49

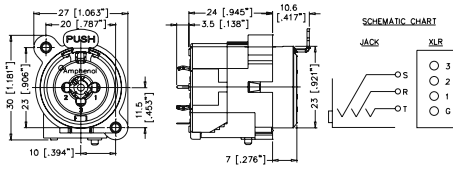
Specifications: Page 51

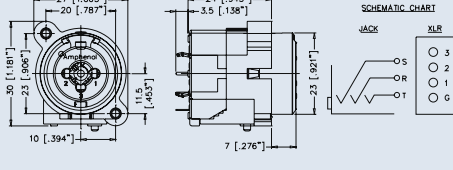
PCB Footprints: Page 50

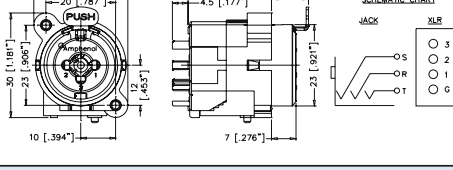
Recommended Fastener: Page 132

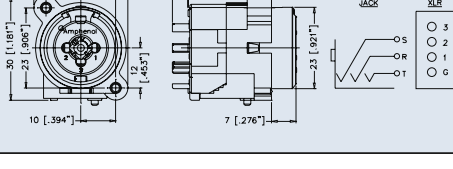
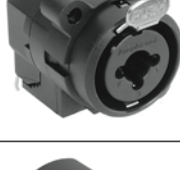
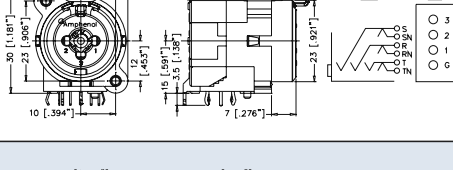
PRODUCT - FIGURE	DRAWING	Dimensions in mm (inches)	DESCRIPTION	VARIATIONS	PART NUMBER
		27 [1.063"], 20 [0.787"], 30 [1.181"], 23 [0.906"], 10 [.394"], 24 [.945"], 10.6 [.417"], 12 [.472"], 7 [.276"], 23 [.921"]	XLR 3 pole female receptacle with 1/4" mono jack without switching contact, Horizontal PCB mount, Bulk Pack	Latching	ACJC5H BULK
		27 [1.063"], 20 [0.787"], 30 [1.181"], 23 [0.906"], 10 [.394"], 24 [.945"], 10.6 [.417"], 12 [.472"], 7 [.276"], 23 [.921"]	XLR 3 pole female receptacle with 1/4" mono jack without switching contact, Horizontal PCB mount, Bulk Pack	Non-latching, Retention Spring	ACJC5HL BULK
		27 [1.063"], 20 [0.787"], 30 [1.181"], 23 [0.906"], 10 [.394"], 24 [.945"], 5.5 [0.217"], 10.6 [.417"], 12 [.472"], 7 [.276"], 23 [.921"]	XLR 3 pole female receptacle with 1/4" mono jack without switching contact, Vertical PCB mount, Bulk Pack	Latching	ACJC5V BULK
		27 [1.063"], 20 [0.787"], 30 [1.181"], 23 [0.906"], 10 [.394"], 24 [.945"], 5.5 [0.217"], 11.5 [.453"], 7 [.276"], 23 [.921"]	XLR 3 pole female receptacle with 1/4" mono jack without switching contact, Vertical PCB mount, Bulk Pack	Non-latching, Retention Spring	ACJC5VL BULK
		27 [1.063"], 20 [0.787"], 30 [1.181"], 23 [0.906"], 10 [.394"], 24 [.945"], 4.5 [0.177"], 10.6 [.417"], 12 [.472"], 7 [.276"], 23 [.921"]	XLR 3 pole female receptacle with 1/4" mono jack without switching contact, Solder Contacts, Bulk Pack	Latching	ACJC5S BULK
		27 [1.063"], 20 [0.787"], 30 [1.181"], 23 [0.906"], 10 [.394"], 24 [.945"], 4.5 [0.177"], 12 [.472"], 7 [.276"], 23 [.921"]	XLR 3 pole female receptacle with 1/4" mono jack without switching contact, Solder Contacts, Bulk Pack	Non-latching, Retention Spring	ACJC5SL BULK

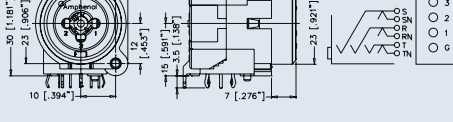
PRODUCT - FIGURE	DRAWING	Dimensions in mm (inches)	DESCRIPTION	VARIATIONS	PART NUMBER
			XLR 3 pole female receptacle with 1/4" stereo jack without switching contact, Horizontal PCB mount, Bulk Pack	Latching	ACJC6H BULK
			XLR 3 pole female receptacle with 1/4" stereo jack without switching contact, Horizontal PCB mount, Bulk Pack	Non-latching, Retention Spring	ACJC6HL BULK
			XLR 3 pole female receptacle with 1/4" stereo jack without switching contact, Vertical PCB mount, Bulk Pack	Latching	ACJC6V BULK
			XLR 3 pole female receptacle with 1/4" stereo jack without switching contact, Vertical PCB mount, Bulk Pack	Non-latching, Retention Spring	ACJC6VL BULK
			XLR 3 pole female receptacle with 1/4" stereo jack without switching contact, Solder Contacts, Bulk Pack	Latching	ACJC6S BULK
			XLR 3 pole female receptacle with 1/4" stereo jack without switching contact, Solder Contacts, Bulk Pack	Non-latching, Retention Spring	ACJC6SL BULK
			XLR 3 pole female receptacle with 1/4" switching stereo jack, Horizontal PCB mount, Bulk Pack	Latching	ACJC9H BULK
			XLR 3 pole female receptacle with 1/4" switching stereo jack, Horizontal PCB mount, Bulk Pack	Non-latching, Retention Spring	ACJC9HL BULK



PRODUCT - FIGURE	DRAWING	Dimensions in mm (inches)	DESCRIPTION	VARIATIONS	PART NUMBER
		27 [1.063] 20 [0.787] 30 [1.181] 23 [0.906] 10 [.394] 12 [.472] 24 [.945] 3.5 [.138] 10.6 [.417] 7 [.276] 23 [.921]	XLR 3 pole female receptacle with 1/4" switching stereo jack, Vertical PCB mount, Bulk Pack	Latching	ACJC9V BULK
		27 [1.063] 20 [0.787] 30 [1.181] 23 [0.906] 10 [.394] 12 [.472] 24 [.945] 3.5 [.138] 7 [.276] 23 [.921]	XLR 3 pole female receptacle with 1/4" switching stereo jack, Vertical PCB mount, Bulk Pack	Non-latching, Retention Spring	ACJC9VL BULK
		27 [1.063] 20 [0.787] 30 [1.181] 23 [0.906] 10 [.394] 12 [.472] 24 [.945] 4.5 [.177] 7 [.276] 23 [.921]	XLR 3 pole female receptacle with 1/4" switching stereo jack, Solder Contacts, Bulk Pack	Latching	ACJC9S BULK
		27 [1.063] 20 [0.787] 30 [1.181] 23 [0.906] 10 [.394] 12 [.472] 24 [.945] 4.5 [.177] 7 [.276] 23 [.921]	XLR 3 pole female receptacle with 1/4" switching stereo jack, Solder Contacts, Bulk Pack	Non-latching, Retention Spring	ACJC9SL BULK
		27 [1.063] 20 [0.787] 30 [1.181] 23 [0.906] 10 [.394] 12 [.472] 15 [.591] 24 [.945] 3.5 [.138] 10.6 [.417] 7 [.276] 23 [.921]	XLR 3 pole female receptacle with 1/4" switching stereo jack and switching ground contact, Horizontal PCB mount, Bulk Pack	Latching	ACJC10H BULK
		27 [1.063] 20 [0.787] 30 [1.181] 23 [0.906] 10 [.394] 12 [.472] 15 [.591] 24 [.945] 3.5 [.138] 7 [.276] 23 [.921]	XLR 3 pole female receptacle with 1/4" switching stereo jack and switching ground contact, Horizontal PCB mount, Bulk Pack	Non-latching, Retention Spring	ACJC10HL BULK
		27 [1.063] 20 [0.787] 30 [1.181] 23 [0.906] 10 [.394] 12 [.472] 24 [.945] 3.5 [.138] 10.6 [.417] 7 [.276] 23 [.921]	XLR 3 pole female receptacle with 1/4" switching stereo jack and switching ground contact, Vertical PCB mount, Bulk Pack	Latching	ACJC10V BULK
		27 [1.063] 20 [0.787] 30 [1.181] 23 [0.906] 10 [.394] 12 [.472] 24 [.945] 4.5 [.177] 7 [.276] 23 [.921]	XLR 3 pole female receptacle with 1/4" switching stereo jack and switching ground contact, Vertical PCB mount, Bulk Pack	Non-latching, Retention Spring	ACJC10VL BULK

PRODUCT - FIGURE	DRAWING	DESCRIPTION	VARIATIONS	PART NUMBER
	<p>Dimensions in mm (inches)</p> <p>SCHEMATIC CHART</p> <p>JACK: XLR</p> <p>3 2 1 G GN</p>	XLR 3 pole female receptacle with 1/4" switching stereo jack and switching ground contact, Solder Contacts, Bulk Pack	Latching	ACJC10S BULK
	<p>Dimensions in mm (inches)</p> <p>SCHEMATIC CHART</p> <p>JACK: XLR</p> <p>3 2 1 G GN</p>	XLR 3 pole female receptacle with 1/4" switching stereo jack and switching ground contact, Solder Contacts, Bulk Pack	Non-latching, Retention Spring	ACJC10SL BULK

PART NUMBER BREAKDOWN

AC SERIES THERMOPLASTIC C TYPE

E. G. **ACJC5HL BULK**
AC (Series Prefix), **JC** Jack/Connector XLR, **5** Mono, **H**orizontal Printed Circuit Board, **L**atchless, **BULK** Packaged.

SERIES PREFIX
 CONNECTOR TYPE
 CONTACT OPTIONS
 HOUSING TYPE
 CONTACT ORIENTATION
 LOCKING MECHANISM
 PACKAGING

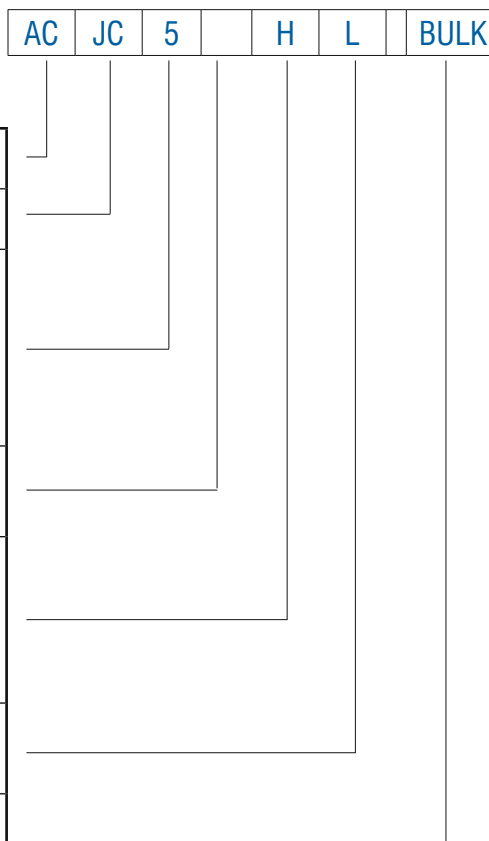

SERIES PREFIX	AC	=	Series Prefix
CONNECTOR TYPE	JC	=	Jack / Connector XLR
CONTACT OPTIONS	5	=	Mono, Non Switching, XLR Grounded
	6	=	Stereo, Non Switching, XLR Grounded
	9	=	Stereo, Switching, XLR Grounded
	10	=	Stereo, Switching, XLR with Ground Switch
HOUSING TYPE	Blank	=	Standard
	A	=	Low Profile / High Density
CONTACT TYPE	V	=	Vertical Printed Circuit Board
	V2	=	Vertical Printed Circuit Board (24mm)
	H	=	Horizontal Printed Circuit Board
	S	=	Solder Contacts
LOCKING MECHANISM	Blank	=	Latching
	L	=	Latchless
PACKAGING	Blank	=	Individual Bags
	BULK	=	Bulk Packed

AC SERIES C TYPE SERIES

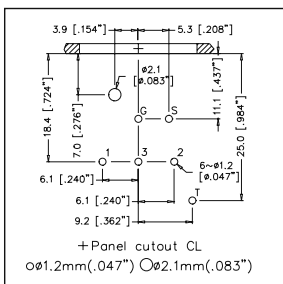

ACJCSH & ACJCSHL

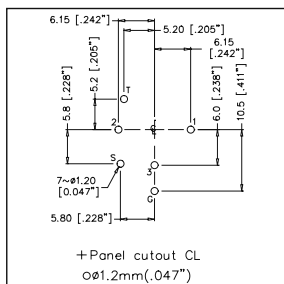

ACJC5V & ACJC5VL

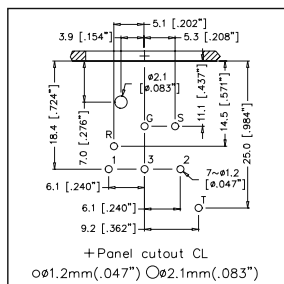

ACJC6H & ACJC6HL

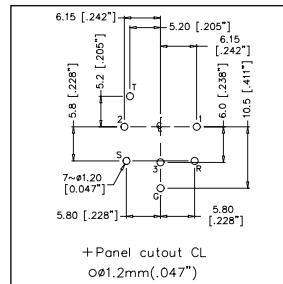

ACJC6V & ACJC6VL

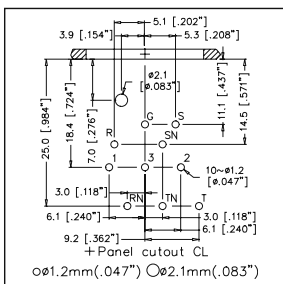

ACJC9H & ACJC9HL

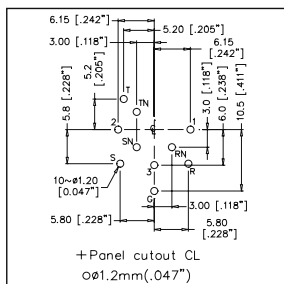

ACJC9V & ACJC9VL

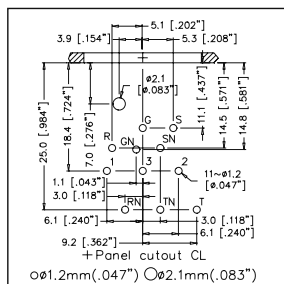

ACJC10H & ACJC10HL

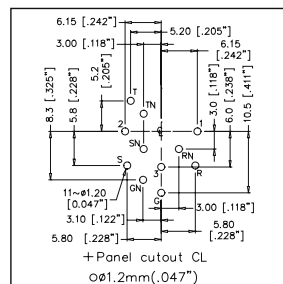

ACJC10V & ACJC10VL

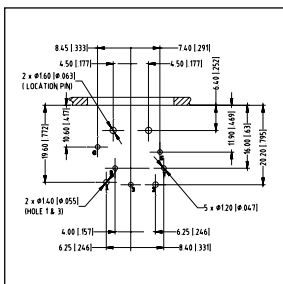

ACJC6AH & ACJC6AHL

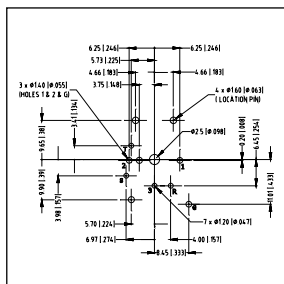

ACJC6AV2 & ACJC6AV2L

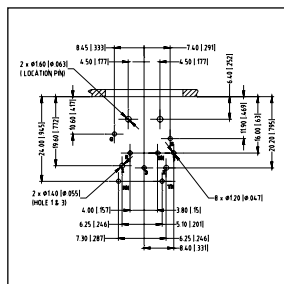

ACJC9AH & ACJC9AHL

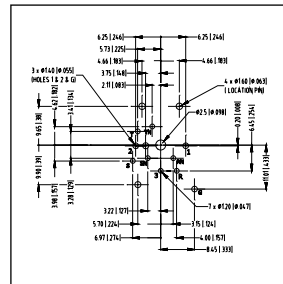

ACJC9AV2 & ACJC9AV2L

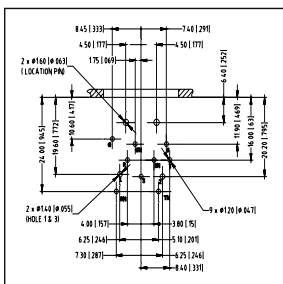

ACJC10AH & ACJC10AHL

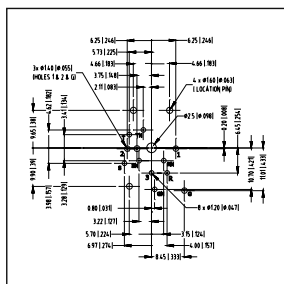

ACJC10AV2 & ACJC10AV2L

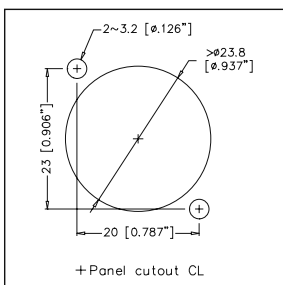

C TYPE PANEL CUTOUT

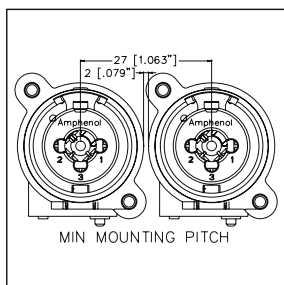

C TYPE MOUNTING PITCH

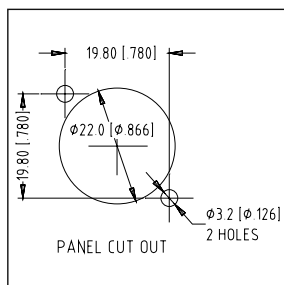

C TYPE LOW PROFILE PANEL CUTOUT

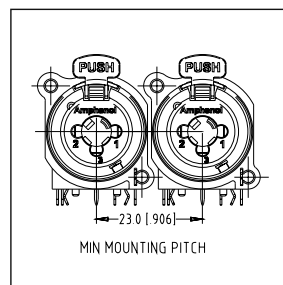

C TYPE LOW PROFILE MOUNTING PITCH

STANDARD DATA C TYPE CHASSIS RECEPTACLES

		VALUE	
		LOW PROFILE TYPE	STANDARD C TYPE
GENERAL CHARACTERISTICS	Number of contacts	5, 6, 9 or 10	
	Termination	Printed Circuit Board (PCB)	Printed Circuit Board (PCB) or Solder Bucket
	Flammability	UL 94HB	
	Environmental	Complies with EU RoHS 2 Directive 2011/65/EU	
ELECTRICAL CHARACTERISTICS	Service Voltage RMS	50V	
	Test Voltage AC RMS	1500V	
	Current carrying capacity	7.5A	
	Typical Contact Resistance	≤50mΩ	
	Insulation Resistance (initial)	> 0.5GΩ	
	Insulation Resistance (after damp heat test)	> 0.2GΩ	
CLIMATIC CHARACTERISTICS	Protection Class	IP40	
	Operating Temperature	-25 °C to +70 °C	
MECHANICAL CHARACTERISTICS	Weight**	9.2g (0.02lb)	14g (0.030lb)
	Retention Spring separating force	≥20N	
	Mounting Screw torque max.	1.5Nm	
	Mechanical Operations	1500 mating cycles	
	Fastening***	Self-Tapping PT screw with thread 2.9 x 1.06 and of Tri-rondular configuration	
MATERIALS	Connector Shell	PA6.6 + 30% glass fibre reinforced, UL94HB	PA6.6 + 20% glass fibre reinforced, UL94HB
	Shell Finish		Black
	Insulators	PA6.6 glass fibre reinforced, UL94HB	PA6.6 + 20% glass fibre reinforced, UL94HB
	XLR Contact		
	Material	Bronze	
	Plating	Gold over Nickel plated	
	Jack Contact		
	Material	Bronze	Brass
Plating	Gold over Nickel plated	Silver over Copper plated	
Latch lock and Spring	Nickel Plated		
Ground element	Nickel Plated	Silver over Copper plated	

**Approximate weight in grams not including packaging. Please contact us for exact weight for shipping purposes.

***Refer to Page 132

Rev 6 - 03/2013

SP/HP/EP/ AP SERIES HIGH POWER / LOUDSPEAKER CONNECTORS



SP Series

The SP Series are available in 2 or 4 pole chassis mount connectors. The durable thermoplastic housings are fitted with high power contacts to ensure optimal current carrying capacity. Completely intermatable with industry standard loudspeaker connections.

Features

- High current contacts for distortion free signal.
- Cost effective durable thermoplastic shell
- Available in 2 and 4 contact arrangements.
- Overmolded cable support boot or PG gland with or without cable support strain relief.
- Quick release, vibration resistant latch lock.
- UL, cUL recognized components (File no. E339831)
- Precision machined contacts
- Thermoplastic shell

Options

- Solder termination / Tab or Printed Circuit Board versions, Screw Terminals
- Nickel Plated Zinc Alloy shell
- Black finished Zinc Alloy shell

HP Series

The HP Series connectors are suitable for power applications where a latch locking connector is required. They are rated at 25A / 250Vac.

Features

- Quick release, vibration resistant latch lock.
- Power connectors colour coded and keyed for power-in (Blue) and power-out (Grey)
- UL, cUL recognized components (File no. E339831)
- Precision machined contacts

EP Series

The EP Series incorporates a rugged zinc diecast shell to give it maximum durability when used in demanding situations. The EP cable connector cable flex relief design minimises cable bend stress at point of entry into the connector housing.

Features

- High current contacts for distortion free signal.
- Tough, durable zinc diecast shell
- Cable clamp capable of supporting cables from 9mm (0.35") to 16mm (0.63") in diameter.
- Quick release, vibration resistant latch lock.
- AP & EP series are completely intermatable.
- Precision machined contacts

Options

- Nickel Plated Zinc Alloy shell
- Black finished Zinc Alloy shell
- Available in 3, 4, 5, 6 and 8 contact arrangements

AP Series

The AP Series Shell is manufactured from tough, durable thermoplastic, and ideal for fixed indoor installations. Both the EP and AP Series utilise the same contact and insulator components.

Features

- High current contacts for distortion free signal.
- Cost effective durable thermoplastic shell
- Quick release, vibration resistant latch lock.
- AP & EP series are completely intermatable.
- Precision machined contacts
- Thermoplastic shell

Options

- Available in 4, 5, 6, and 8 contact arrangements.

Ordering Codes

We have listed the more common ordering codes in each section. Please contact us if you need any further assistance.

Simple steps to guide you in using this catalogue

- 1) Identify the product group listed in Contents on page 1 and go directly to that page number.
- 2) Each product group cover page then details information and options available.
- 3) Refer to the product detail pages and identify the product you require pictorially.
- 4) Read the product description column for the products standard features.
- 5) Use variations column to determine your choice.
- 6) Identify part number.
- 7) In the event the particular option you require is not listed please refer to the part number breakdown page at the end of each section.
- 8) Please contact us directly if you have any further problems.



Amphenol's range of loudspeaker connectors have been further enhanced with the introduction of the SP Series. Designed to complement the popular EP/AP Series, we now offer a range of loudspeaker connectors to suit most applications. SP Series chassis connectors are available in industry standard PCB footprints with solder tabs. SP Series cable plugs are available with screw or solder terminals.

Features:









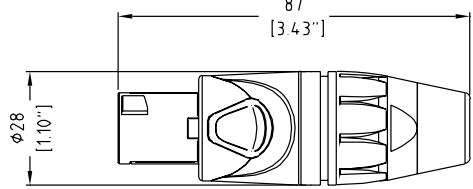

- Quick release, vibration resistant latch lock
- 2 or 4 pole
- Solder tabs, PCB Contacts, Solder or Screw Terminals
- Chuck type or PG Gland cable clamp
- Various mounting hole options
- 30A Current rating
- Thermoplastic or Metal housing (Cable Plugs)
- UL, cUL recognized components (File no. E339831)
- Industry standard mating

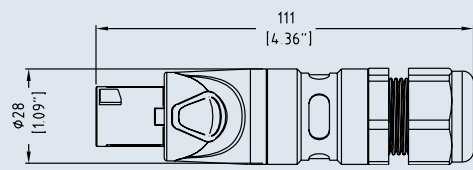

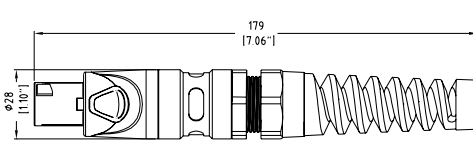
Part Number Breakdown: Page 57 Specifications: Page 61
PCB Footprints: Page 59 Assembly Instructions: 60

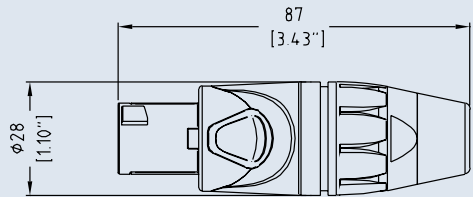
PRODUCT - FIGURE	DRAWING	Dimensions in mm (inches)	DESCRIPTION	CONTACT TYPE	SHELL COLOUR	PART NUMBER
			2 pole, Cable connector, Thermoplastic shell, Blue sleeve	Screw	Black	SP-2-F
				Solder	Black	SP-2-FS
			2 pole, Cable connector, Thermoplastic shell, Blue sleeve, PG Gland	Screw	Black	SP-2-FG
				Solder	Black	SP-2-FSG
			2 pole, Cable connector, Thermoplastic shell, Blue sleeve, PG Gland strain relief	Screw	Black	SP-2-FL
				Solder	Black	SP-2-FSL
			2 pole, Cable connector, Metal shell, Blue sleeve	Screw	Nickel	SP-2-FN
				Solder	Nickel	SP-2-FNS
				Screw	Black	SP-2-FB
				Solder	Black	SP-2-FBS
			2 pole, Cable connector, Metal shell, Blue sleeve, PG Gland	Screw	Nickel	SP-2-FNG
				Solder	Nickel	SP-2-FNSG
				Screw	Black	SP-2-FBG
				Solder	Black	SP-2-FBSG
			2 pole, Cable connector, Metal shell, Blue sleeve, PG Gland strain relief	Screw	Nickel	SP-2-FNL
				Solder	Nickel	SP-2-FNSL
				Screw	Black	SP-2-FBL
				Solder	Black	SP-2-FBSL

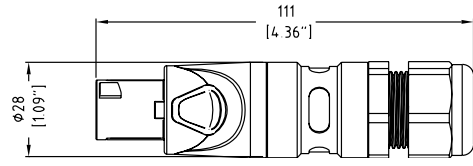

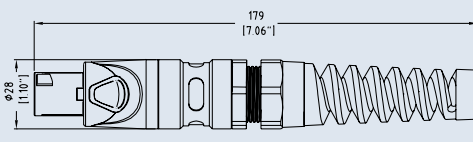





PRODUCT - FIGURE	DRAWING	DESCRIPTION	CONTACT TYPE	SHELL COLOUR	PART NUMBER
	 <p>Dimensions in mm (inches)</p>	4 pole, Cable connector, Thermoplastic black shell, Blue sleeve	Screw	Black	SP-4-F
			Solder	Black	SP-4-FS
		4 pole, Cable connector, Thermoplastic black shell, Blue sleeve, PG Gland	Screw	Black	SP-4-FG
			Solder	Black	SP-4-FSG
		4 pole, Cable connector, Thermoplastic black shell, Blue sleeve, PG Gland strain relief	Screw	Black	SP-4-FL
			Solder	Black	SP-4-FSL
		4 pole, Cable connector, Metal shell, Blue sleeve	Screw	Nickel	SP-4-FN
			Solder	Nickel	SP-4-FNS
			Screw	Black	SP-4-FB
			Solder	Black	SP-4-FBS
		4 pole, Cable connector, Metal shell, Blue sleeve, PG Gland	Screw	Nickel	SP-4-FNG
			Solder	Nickel	SP-4-FNSG
			Screw	Black	SP-4-FBG
			Solder	Black	SP-4-FBSG
		4 pole, Cable connector, Metal shell, Blue sleeve, PG Gland strain relief	Screw	Nickel	SP-4-FNL
			Solder	Nickel	SP-4-FNSL
			Screw	Black	SP-4-FBL
			Solder	Black	SP-4-FBSL

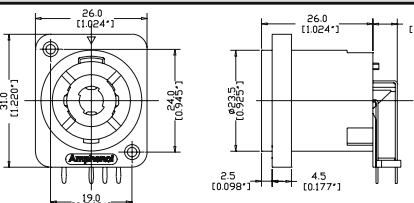

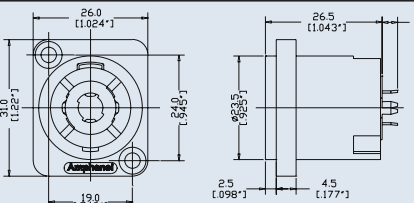
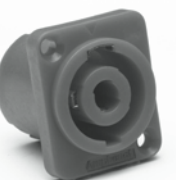
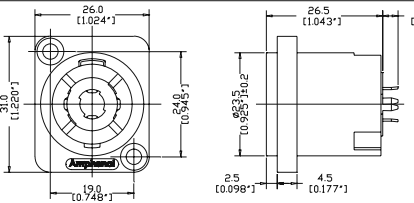
PRODUCT - FIGURE	DRAWING	Dimensions in mm (inches)	DESCRIPTION	VARIATIONS	PART NUMBER
		26.0 (1.024") 31.0 (1.220") 24.0 (0.945") 19.0 (0.748") 28.2 (1.110") 4.3 (0.169") ø23.5 (0.925") 2.5 (0.098") 4.5 (0.177")	2 pole, D flange, Thru holes, Solder tabs 3/16"	Black	SP-2-MD
		26.0 (1.024") 31.0 (1.220") 24.0 (0.945") 19.0 (0.748") 26.0 (1.024") 5.7 (0.224") ø23.5 (0.925") 2.5 (0.098") 4.5 (0.177")	2 pole, D flange, Thru holes, Horizontal PCB	Black	SP-2-MDH
		26.0 (1.024") 31.0 (1.220") 24.0 (0.945") 19.0 (0.748") 26.5 (1.043") 3.5 (0.138") ø23.5 (0.925") 2.5 (0.098") 4.5 (0.177")	2 pole, D flange, Thru holes, Vertical PCB	Black	SP-2-MDV
		26.0 (1.024") 31.0 (1.220") 24.0 (0.945") 19.0 (0.748") 28.2 (1.110") 4.3 (0.169") ø23.5 (0.925") 2.5 (0.098") 4.5 (0.177")	4 pole, D flange, Thru holes, Solder tabs 3/16"	Black	SP-4-MD
		26.0 (1.024") 31.0 (1.220") 24.0 (0.945") 19.0 (0.748") 28.2 (1.110") 4.3 (0.169") ø23.5 (0.925") 2.5 (0.098") 4.5 (0.177")	4 pole, D flange, Thru holes, Solder tabs 3/16"	Grey	SP-4-MD-8
		26.0 (1.024") 31.0 (1.220") 24.0 (0.945") 19.0 (0.748") 28.2 (1.110") 4.3 (0.169") ø23.5 (0.925") 2.5 (0.098") 4.5 (0.177")	4 pole, D flange, Self Tapping holes, Solder tabs 3/16"	Black	SP-4-MDT
		26.0 (1.024") 31.0 (1.220") 24.0 (0.945") 19.0 (0.748") 26.0 (1.024") 5.7 (0.224") ø23.5 (0.925") 2.5 (0.098") 4.5 (0.177")	4 pole, D flange, Thru holes, Horizontal PCB	Black	SP-4-MDH
		26.0 (1.024") 31.0 (1.220") 24.0 (0.945") 19.0 (0.748") 26.0 (1.024") 5.7 (0.224") ø23.5 (0.925") 2.5 (0.098") 4.5 (0.177")	4 pole, D flange, Self Tapping holes, Horizontal PCB	Grey	SP-4-MDHT-8

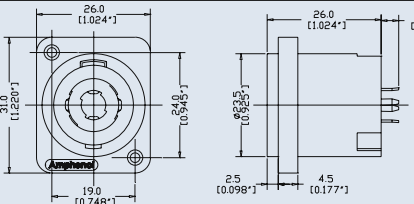

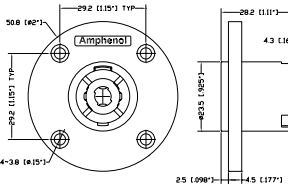
PRODUCT - FIGURE		DESCRIPTION	VARIATIONS	PART NUMBER
		4 pole, D flange, Self Tapping holes, Horizontal PCB	Black	SP-4-MDHT
		4 pole, D flange, Thru holes, Vertical PCB	Black	SP-4-MDV
		4 pole, D flange, Thru holes, Vertical PCB	Red	SP-4-MDV-2
		4 pole, D flange, Self Tapping holes, Vertical PCB	Grey	SP-4-MDVT-8
		4 pole, EP flange, Thru holes, Solder tabs 3/16"	Black	SP-4-MC



PART NUMBER BREAKDOWN

SP SERIES - CABLE CONNECTORS

E. G . **SP-4-FNSG**
SP (Series Prefix), **4** contacts, **F** (Cable Connector), **N** (Metal Shell Nickel Finish),
S (Solder Terminals), **G** (PG Gland)

SERIES PREFIX	SP	=	Series Prefix
CONTACT LAYOUT	2	=	2 Contacts
	4	=	4 Contacts
GENDER	F	=	Cable Connector
SHELL FINISH	Blank	=	Thermoplastic - Black
	N	=	Metal - Nickel Finish
	B	=	Metal - Black Finish
TERMINATION	Blank	=	Screw Terminals
	S	=	Solder Terminals
BACKSHELL TYPE	Blank	=	Standard
	G	=	PG Gland
	L	=	PG Gland Strain Relief
PACKAGING	Blank	=	Individual Bags
	B	=	Bulk Packed

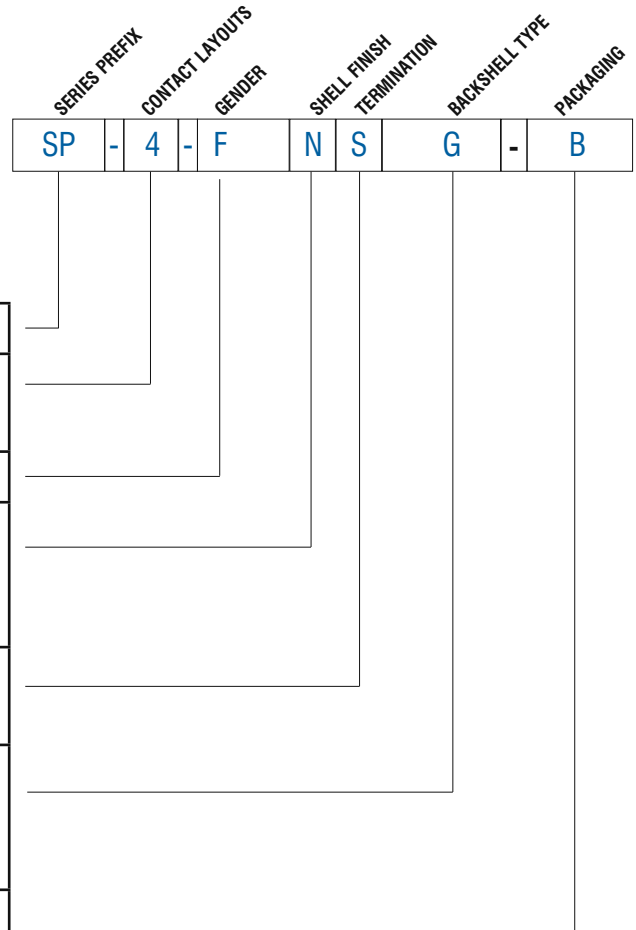

PART NUMBER BREAKDOWN

SP SERIES - CHASSIS CONNECTORS

E. G. **SP-4-MDHT-8B**
SP (Series Prefix), **4** contacts, **M**(Chassis Connector), **D** (D Shell), **H**orizontal Printed Circuit Board, Self **T**apping mounting holes - **8** (Grey), **B**ulk Packaged.

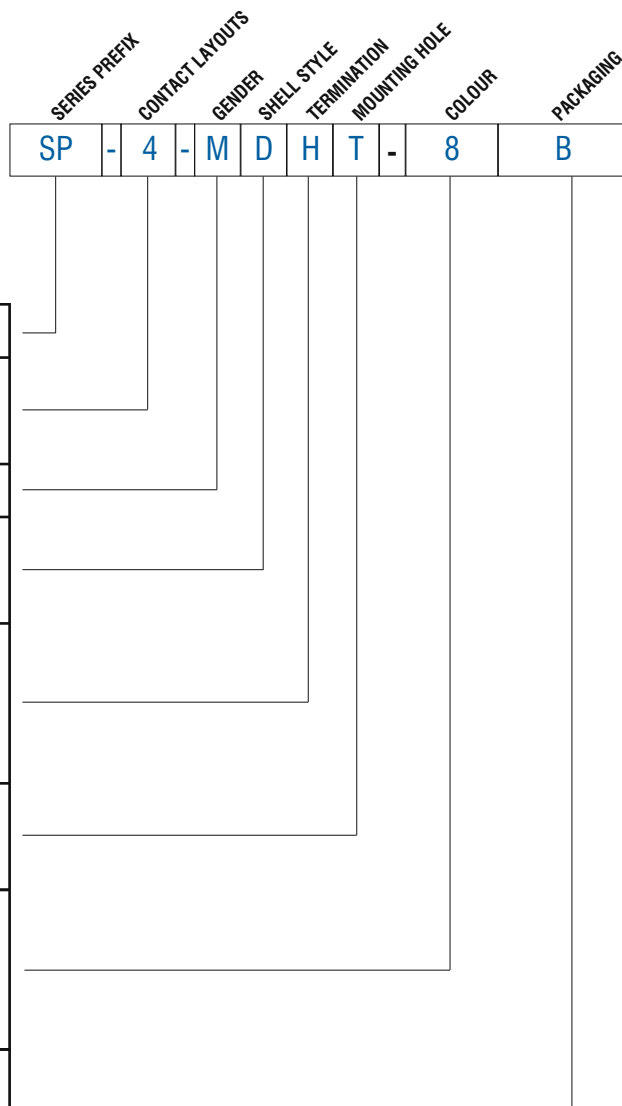

SERIES PREFIX	SP	=	Series Prefix
CONTACT LAYOUT	2	=	2 Contacts
	4	=	4 Contacts
GENDER	M	=	Chassis Connector
SHELL STYLE	D	=	Standard 'D' Type flange
	C	=	EP Series Circular flange
TERMINATION	Blank	=	Solder tabs - 3/16" terminals
	V	=	Vertical Printed Circuit Board
	H	=	Horizontal Printed Circuit Board
MOUNTING HOLE	Blank	=	Thru Hole
	T	=	Self Tapping
SHELL COLOUR	Blank	=	Black
	2	=	Red
	8	=	Grey
PACKAGING	Blank	=	Individual Bags
	B	=	Bulk Packed



SP SERIES

SP-2-MDH

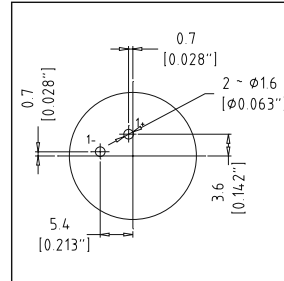
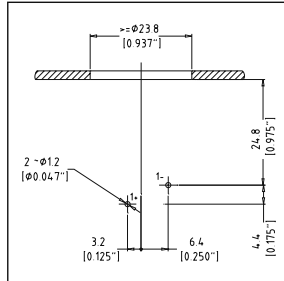

SP-2-MDV

**SP-4-MDH
SP-4-MDHT-8
SP-4-MDHT**

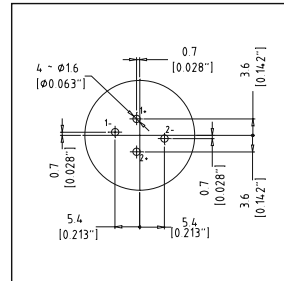
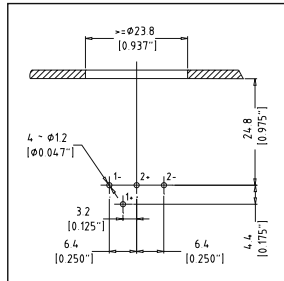

**SP-4-MDV
SP-4-MDV-2
SP-4-MDVT-8**

SP SERIES PANEL CUTOUT

SP-2-MD *
SP-4-MD** *
_**

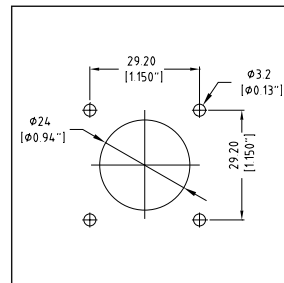
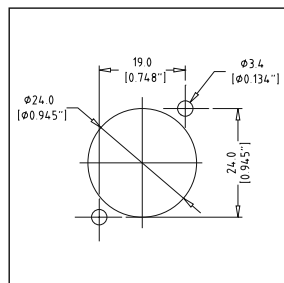

SP-4-MC



PI 1070 ASSEMBLY INSTRUCTIONS

SP SERIES CABLE CONNECTOR

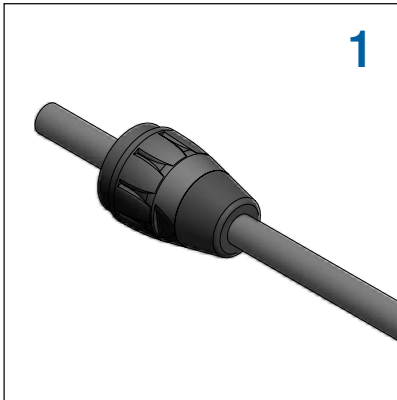

1

Slide the nut onto the cable

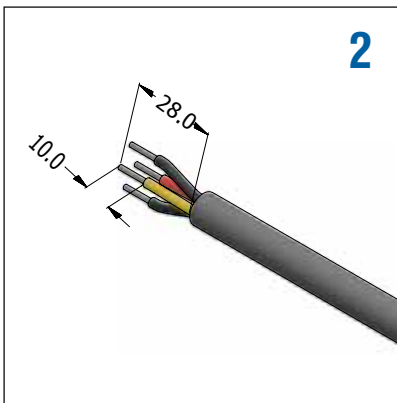

2

Strip the cable and twist the conductors.

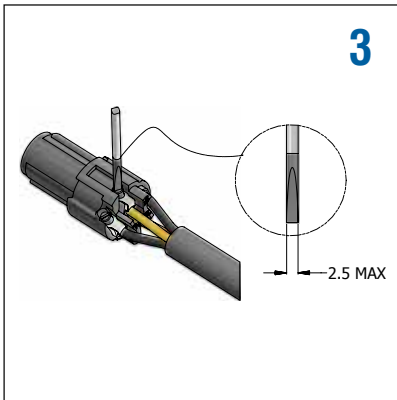

3

Insert the conductors into the rear of contacts on the insert. Tighten the screws to 0.35Nm (3.0 lb-in) using a flat screwdriver with tip width of 2.5mm max.

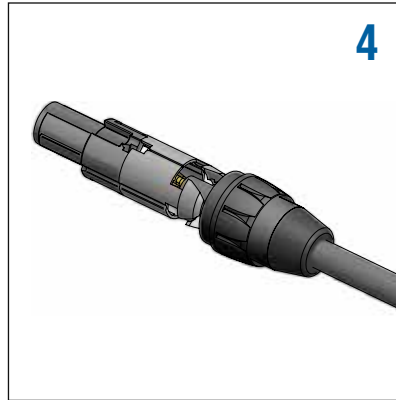

4

Install the cable clamp, flush to the insert making sure to align the slot as shown in the picture.

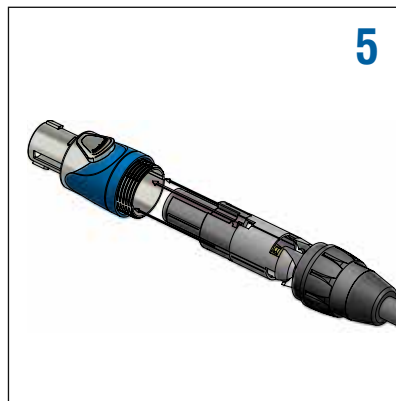

5

Orientate the insert and cable clamp as shown then push all together into the shell.

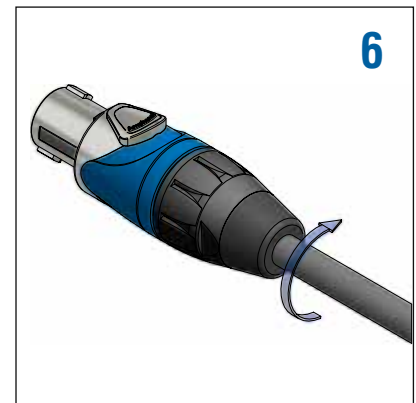

6

Thread the nut onto the shell to activate the cable clamp and close the connector assembly.

STANDARD DATA SP SERIES CONNECTORS

		VALUE
GENERAL CHARACTERISTICS	Number of contacts	2 or 4
	Termination (Chassis)	Printed Circuit Board (PCB) or Solder Tabs 3/16"
	Termination (Cable Plugs)	Screw or Solder Terminals
	Flammability	UL94HB
	Environmental	Complies with EU RoHS 2 Directive 2011/65/EU
ELECTRICAL CHARACTERISTICS	Service Voltage RMS	133V ¹⁾
	Test Voltage AC RMS	1500V
	Current carrying capacity	30A
	Typical Contact Resistance	≤3mΩ
	Insulation Resistance (initial)	≥2GΩ
	Insulation Resistance (after damp heat test)	≥1GΩ
CLIMATIC CHARACTERISTICS	Protection Class	IP54
	Operating Temperature	-25 °C to +75 °C (-13°F to +167°F)
MECHANICAL CHARACTERISTICS	Weight** - Chassis Connectors	12g (0.026lb)
	Weight** - Cable Plug - Thermoplastic - Metal	44g (0.097lb)
		65g (0.143lb)
	Weight** - Cable Plug PG - Thermoplastic - Metal	44g (0.097lb)
		65g (0.143lb)
	Weight** - Cable Plug PG S/Relief - Thermoplastic - Metal	68g (0.150lb)
		89g (0.196lb)
	Typical Cable retention force	200N (Subject to cable material and O.D.)
Cable O.D range - Chuck Clamp - PG16 Gland - PG16 Gland S/Relief	2 pole 5-10mm (0.19" - 0.39")	4 pole 9-14mm (0.35" - 0.55")
	6-12mm (0.23" - 0.47")	8-14mm (0.31" - 0.55")
	9-14mm (0.35" - 0.55")	9-14mm (0.35" - 0.55")
	Conductor Size - Screw Terminals - Solder Bucket	1.5mm ² - 4mm ² (AWG16 - AWG12) 1.5mm ² - 6mm ² (AWG16 - AWG10)
MATERIALS	Connector Shell / Finish - Cable Plug Thermoplastic - Cable Plug Metal	PA66 GF30 / Black Diecast Zinc Alloy / Nickel or Black
	Insulators - Chassis - Cable Plugs	PA66 GF20 PA66 GF30
	Cable Boot / Backshell	Santoprene / PA6 GF 15
	Cable Clamp (Chuck)	P.O.M
	Cable Clamp (PG)	Polyamide / EPDM
	Sleeve	PBT
	Contact Chassis - Material / Plating Contact Cable Plug - Material / Plating	Phosphor Bronze / Silver Brass / Silver



Rev 5 - 03/2013

**Approximate weight in grams not including packaging. Please contact us for exact weight for shipping purposes.

¹⁾Not suitable for domestic applications above 50V

Amphenol

EP / AP / SP / HP SERIES

HP POWER CONNECTORS



HP Series connectors are suitable for AC power supply where a latch locking connector is required. They are rated at 25 A / 250 Vac. Connectors are keyed and colour coded for power-in (Blue) and power-out (Grey).

⚠ THE HP SERIES OF CONNECTORS ARE NOT DESIGNED TO BE "HOT PLUGGED" AND SO ARE WITHOUT "BREAKING CAPACITY". IN OTHER WORDS, THE CONNECTORS SHOULD NOT BE CONNECTED OR DISCONNECTED LIVE OR WHEN UNDER LOAD

Features:

- Quick release, vibration resistant latch lock
- 3 pole
- Screw Terminals or Solder Tab 3/16"
- Chuck type cable clamp
- 25A Current rating
- Thermoplastic housing
- Industry standard mating
- UL, cUL recognized components (File no. E339831)



Specifications: Page 63

PRODUCT - FIGURE	DRAWING	Dimensions in mm (inches)	DESCRIPTION	CONTACT TYPE	SHELL COLOUR	PART NUMBER
			3 pole, Cable connector, Thermoplastic shell, Blue sleeve, keyed for power-in	Screw	Blue	HP-3-F
			3 pole, Cable connector, Thermoplastic shell, Grey sleeve, keyed for power-out	Screw	Grey	HP-3-FG
			3 pole, Chassis connector, Thermoplastic shell, Blue, keyed for power-in	Solder Tab 3/16"	Blue	HP-3-MD
			3 pole, Chassis connector, Thermoplastic shell, Grey, keyed for power-out	Solder Tab 3/16"	Grey	HP-3-MDG
			3 pole, Chassis connector, Thermoplastic shell, Blue, keyed for power-in, without insulation divider	Solder Tab 3/16"	Blue	HP-3-MDW
			3 pole, Chassis connector, Thermoplastic shell, Grey, keyed for power-out, without insulation divider	Solder Tab 3/16"	Grey	HP-3-MDGW



STANDARD DATA HP SERIES CONNECTORS

		VALUE
GENERAL CHARACTERISTICS	Number of contacts	2 + PE
	Termination	Screw or Solder Tab 3/16"
	Flammability	UL94V-0
	Environmental	Complies with EU RoHS 2 Directive 2011/65/EU
ELECTRICAL CHARACTERISTICS	Rated Operating Voltage	250VAC
	Test Voltage AC RMS	1500V
	Current carrying capacity	25A
	Typical Contact Resistance	≤3mΩ
	Insulation Resistance (initial)	≥2GΩ
	Insulation Resistance (after damp heat test)	≥1GΩ
CLIMATIC CHARACTERISTICS	Protection Class	IP54
	Operating Temperature	-25 °C to +75 °C (-13°F to +167°F)
MECHANICAL CHARACTERISTICS	Weight** - Chassis Connector - Cable Plug	12g (0.026lb) 32g (0.070lb)
	Typical Cable retention force	200N (Subject to cable material and O.D.)
	Cable O.D range - Blue Chuck Clamp - Black Chuck Clamp	5mm - 7.5mm (0.19" - 0.29") 7.5mm - 15mm (0.29" - 0.59")
	Conductor Size - Screw Terminals	2.5mm ² (AWG14)
	MATERIALS	Connector Shell / Finish
	Insulators	PA66 GF30
	Cable Boot / Backshell	Santoprene / PBT
	Cable Clamp (Chuck)	P.O.M
	Contact Plug - Material / Plating	Brass / Silver
	Contact Chassis - Material / Plating	Phosphor Bronze / Silver

Rev 3 - 05/2015



**Approximate weight in grams not including packaging. Please contact us for exact weight for shipping purposes.





The EP Series has set the standard in high performance speaker connectors. Apart from its durability and strength, it offers consistent superior power handling capabilities.

Features:



- Solder Bucket connections.
- Precision machined contacts.
- Diecast Metal Housings
- High current contacts
- Male and female cable and chassis connectors available.

Options: Black Finish Shell
Panel Cutouts: Page 68

Specifications: Page 67

PRODUCT - FIGURE	DRAWING	DESCRIPTION	VARIATIONS	PART NUMBER
 <p>ISO ASSEMBLY OF EP MALE</p>		<p>EP Male cable connector, Machined contacts, Metal Shell</p>	3 pole nickel finish	EP-3-12
			3 pole black finish	EP-3-12B
			4 pole nickel finish	EP-4-12
			4 pole black finish	EP-4-12B
			5 pole nickel finish	EP-5-12
			5 pole black finish	EP-5-12B
			6 pole nickel finish	EP-6-12
			6 pole black finish	EP-6-12B
			8 pole nickel finish	EP-8-12
8 pole black finish	EP-8-12B			
 <p>ISO ASSEMBLY OF EP FEMALE</p>		<p>EP Female cable connector, Machined contacts, Metal Shell</p>	3 pole nickel finish	EP-3-11P
			3 pole black finish	EP-3-11PB
			4 pole nickel finish	EP-4-11P
			4 pole black finish	EP-4-11PB
			5 pole nickel finish	EP-5-11P
			5 pole black finish	EP-5-11PB
			6 pole nickel finish	EP-6-11P
			6 pole black finish	EP-6-11PB
			8 pole nickel finish	EP-8-11P
8 pole black finish	EP-8-11PB			

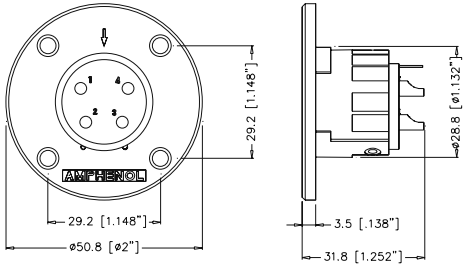

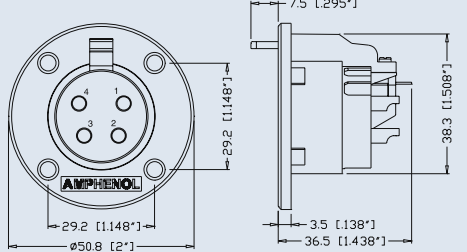
PRODUCT - FIGURE	DRAWING Dimensions in mm (inches)	DESCRIPTION	VARIATIONS	PART NUMBER
		<p>EP Male chassis mount, Round Flange, Machined contacts, Metal Shell</p>	3 pole nickel finish	EP-3-14
			3 pole black finish	EP-3-14B
			4 pole nickel finish	EP-4-14
			4 pole black finish	EP-4-14B
			5 pole nickel finish	EP-5-14
			5 pole black finish	EP-5-14B
			6 pole nickel finish	EP-6-14
			6 pole black finish	EP-6-14B
			8 pole nickel finish	EP-8-14
			8 pole black finish	EP-8-14B
		<p>EP Female chassis mount, Round Flange, Machined contacts, Metal Shell</p>	3 pole nickel finish	EP-3-13P
			3 pole black finish	EP-3-13PB
			4 pole nickel finish	EP-4-13P
			4 pole black finish	EP-4-13PB
			5 pole nickel finish	EP-5-13P
			5 pole black finish	EP-5-13PB
			6 pole nickel finish	EP-6-13P
			6 pole black finish	EP-6-13PB
			8 pole nickel finish	EP-8-13P
			8 pole black finish	EP-8-13PB





The AP Series provides the same power handling performance as the EP Series in a cost effective, yet durable Thermoplastic housing.

Features:

- Solder Bucket connections.
- Precision machined contacts.
- Thermoplastic Housings
- High current contacts
- Male & Female Cable and Chassis connectors available.

Specifications: Page 67

Panel Cutouts: Page 68

PRODUCT - FIGURE	DRAWING	Dimensions in mm (inches)	DESCRIPTION	VARIATIONS	PART NUMBER
		28.8 [1.135"] 100.0 [3.937"]	AP Male cable connector, Machined contacts, Thermoplastic Black shell.	4 pole 5 pole 6 pole 8 pole	AP-4-12 AP-5-12 AP-6-12 AP-8-12
		28.8 [1.132"] 98.7 [3.886"]	AP Female cable connector, Machined contacts, Thermoplastic Black shell.	4 pole 5 pole 6 pole 8 pole	AP-4-11 AP-5-11 AP-6-11 AP-8-11
		29.2 [1.15"] 432.4 [16.276"] 29.2 [1.15"] 450.8 [17.75"] 31.8 [1.252"]	AP Male chassis mount, Round Flange, Machined contacts, Thermoplastic Black shell.	4 pole 5 pole 6 pole 8 pole	AP-4-14 AP-5-14 AP-6-14 AP-8-14
		29.2 [1.148"] 432.4 [16.276"] 29.2 [1.148"] 450.8 [17.75"] 36.5 [1.438"]	AP Female chassis mount, Round Flange, Machined contacts, Thermoplastic Black shell.	4 pole 5 pole 6 pole 8 pole	AP-4-13 AP-5-13 AP-6-13 AP-8-13
		29.2 [1.148"] 432.4 [16.276"] 29.2 [1.148"] 50.0 [1.969"] 40.0 [1.575"]	AP Male chassis mount, Rectangular Flange, Machined contacts, Thermoplastic Black shell.	4 pole 5 pole 6 pole 8 pole	AP-4-22 AP-5-22 AP-6-22 AP-8-22
		29.2 [1.148"] 432.4 [16.276"] 29.2 [1.148"] 50.0 [1.969"] 40.0 [1.575"]	AP Female chassis mount, Rectangular Flange, Machined contacts, Thermoplastic Black shell.	4 pole 5 pole 6 pole 8 pole	AP-4-21 AP-5-21 AP-6-21 AP-8-21

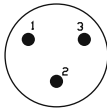
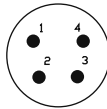
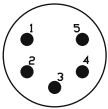
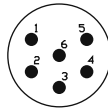
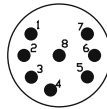

STANDARD DATA EP/AP

		VALUE				
GENERAL CHARACTERISTICS	Number of contacts	3	4	5	6	8
	Contact Arrangements (Front view of pin insert)					
	Termination	SOLDER				
	Wire Gauge - Stranded wire:	12AWG	12AWG	12AWG	12AWG	14AWG
	Flammability	UL94V-0				
Environmental	Complies with EU RoHS 2 Directive 2011/65/EU					
ELECTRICAL CHARACTERISTICS	Service Voltage RMS ¹⁾	460V	660V	200V	200V	100V
	Test Voltage AC RMS	2400V	3000V	1600V	1600V	1300V
	Current carrying capacity	20A	20A	20A	20A	15A
	Typical Contact Resistance	≤3mΩ				
	Insulation Resistance	≥1000MΩ				
CLIMATIC CHARACTERISTICS	Protection Class	IP40				
	Operating Temperature	-25 °C to +75 °C (-13°F to +167°F)				
MECHANICAL CHARACTERISTICS	Weight - EP 11 & 12 ²⁾	80g (0.176lb)	84g (0.185lb)	86g (0.189lb)	86g (0.189lb)	86g (0.189lb)
	Weight - EP 13 & 14 ²⁾	48g (0.105lb)	50g (0.110lb)	54g (0.119lb)	54g (0.119lb)	54g (0.119lb)
	Weight - AP 11 & 12 ²⁾	N/A	42g (0.092lb)	44g (0.097lb)	44g (0.097lb)	44g (0.097lb)
	Weight - AP 13, 14, 21 & 22 ²⁾	N/A	26g (0.057lb)	30g (0.066lb)	30g (0.066lb)	28g (0.061lb)
	Typical Cable retention force	22Kg to 44Kg (50lb to 100lb) - Dependant on cable material and diameter				
	Mechanical operations	1000 mating cycles				

¹⁾ Not suitable for domestic applications above 50V

²⁾ Approximate weight only, does not include packaging. Please contact us for exact weight for shipping purposes.



STANDARD DATA EP/AP (CONT'D)

MATERIALS		DETAILS	
		AP	EP
Connector shell		Modified PPE Resin	Diecast Zinc Alloy
Shell finish		Black	Satin Nickel or Black
Insulators		UL94V-0 PBT Resin	
Cable Bushing		Silicon Rubber	UL94 HB Thermoplastic Elastomer
Male contact Machined - Solder		Brass / Bright Tin	
Material / Plating			
Female contact Machined - Solder		Brass / Bright Tin	
Material / Plating			
CLAMPING CHARACTERISTICS	Cable OD Range	11mm to 17mm (0.43" to 0.67")	9mm to 16mm (0.35" to 0.63")
	Retention Method	Two opposing plastic screws	Metal saddle clamp

Rev 3 - 03/2013

EP/AP SERIES PANEL CUTOUT DATA - FRONT VIEW

EP 13/AP 13/AP 21

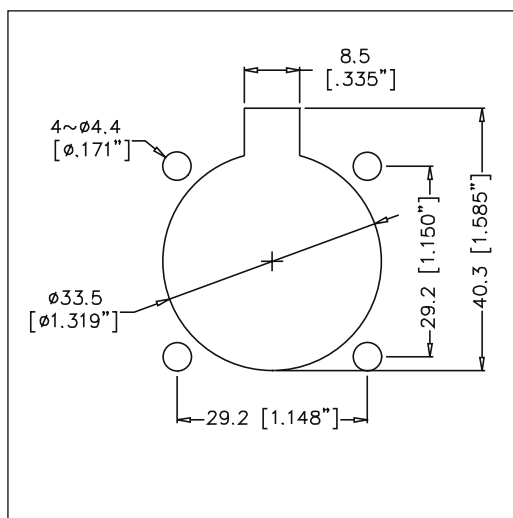

EP 14/AP 14/AP 22

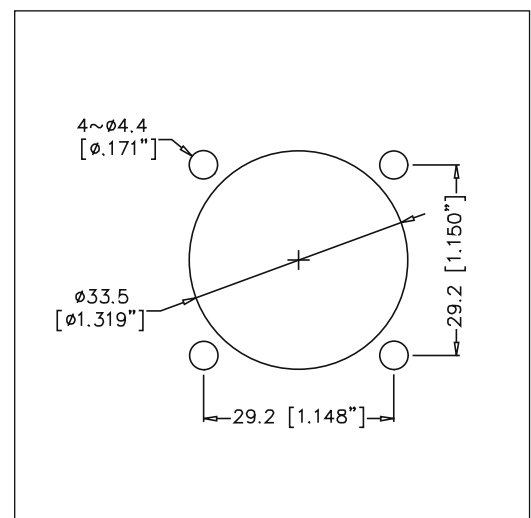



XLrnet CONNECTORS

XLrnet was designed in conjunction with the Amphenol Data / Telecom product group of Amphenol Canada Corp., a subsidiary of Amphenol Corporation. Utilising our combined expertise and knowledge of the professional audio and high-speed data markets we are proud to offer the XLrnet series. Featuring Class D (10/100 BASE-T), CAT5E (1000 BASE-T) or CAT6 (10GBASE-T) ethernet performance in A, B or D shell housings with integrated LED's and complete shielding options we have your high-speed data requirements covered.

Features

- Class D (10/100 BASE-T), CAT5E (1000 BASE-T) or CAT6 (10GBASE-T) ethernet performance
- A, B or D type chassis housings
- IDC or IDC 110 punch down terminals
- RJ45 feedthrough panel connectors
- Shielded or non-shielded
- LED indicators in a variety of colours.
- Compact design
- Cable plug housings
- Quick and simple installation

Options

- Horizontal or Vertical PCB contacts
- Bulk Packaging
- LED colour - Red, Green, Yellow or Blue combinations

Ordering Codes

We have listed the more common ordering codes in each section. Please contact us if you need any further assistance.

Simple steps to guide you in using this catalogue

- 1) Identify the product group listed in Contents on page 1 and go directly to that page number.
- 2) Each product group cover page then details information and options available.
- 3) Refer to the product detail pages and identify the product you require pictorially.
- 4) Read the product description column for the products standard features.
- 5) Use variations column to determine your choice.
- 6) Identify part number.
- 7) In the event the particular option you require is not listed please refer to the part number breakdown page at the end of each section.
- 8) Please contact us directly if you have any further problems.





XLRnet SERIES

Features/Benefits:

- XLR RJ45 Cable plug housing.
- Designed for pre-assembled RJ45 cables.
- Quick and simple installation.
- Cost effective method for harsh environments.
- No cabling in field required.
- No tools required for installation.
- Available in Nickel or Black housings.
- Coloured boots / Backshells

Specifications: Page 71

Part Number Breakdown : Page 71

Assembly Instructions: Page 72

NOTE* RJ45 preassembled cable sold separately and is not included with the XLRnet connector.

PRODUCT - FIGURE	DRAWING	Dimensions in mm (inches)	DESCRIPTION	VARIATIONS	PART NUMBER
		84 [3.31"] 21 [0.81"]	XLRnet, XLR cable plug housing to suit pre-assembled RJ45 cables, Nickel Finish	Standard Bulk Pack	RJX8M RJX8M BULK
		84 [3.31"] 21 [0.81"]	XLRnet, XLR cable plug housing to suit pre-assembled RJ45 cables, Black Finish	Standard Bulk Pack	RJX8MB RJX8MB BULK



ISO VIEW OF RJX8M

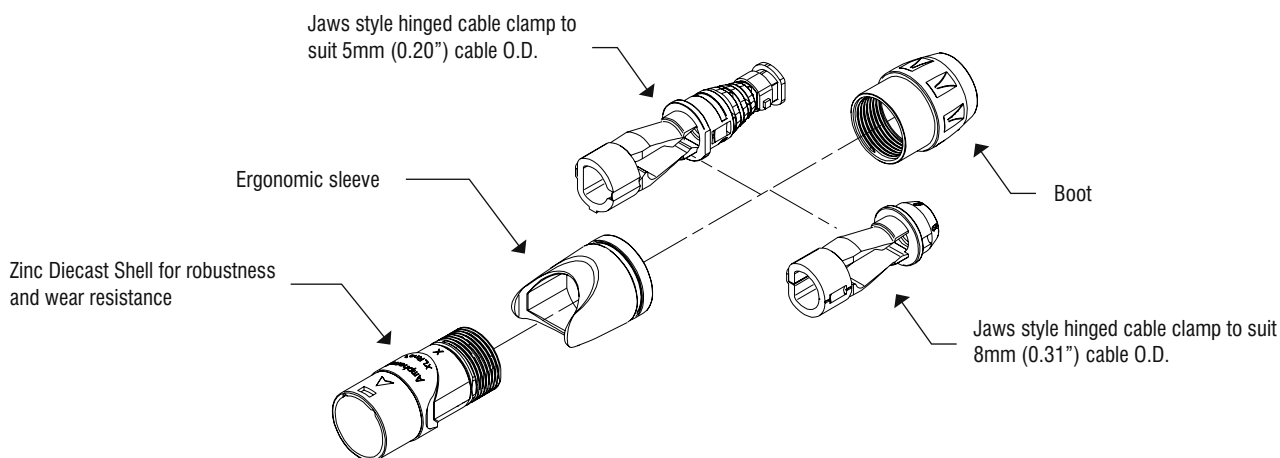

PART NUMBER BREAKDOWN

XLRnet SERIES

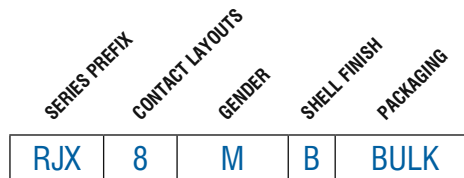

E. G. **RJX8MB BULK**
RJX (Series Prefix), **8** contacts, **M** (Cable Connector), **B** (Black Finish),
Bulk Packaged

SERIES PREFIX	RJX	=	Series Prefix
CONTACT LAYOUT	8	=	RJ45 Cable Housing
GENDER	M	=	Male Cable Plug
SHELL FINISH	Blank	=	Nickel Plated Finish
	B	=	Metal - Black Finish
PACKAGING	Blank	=	Individual Bags
	BULK	=	Bulk Packed

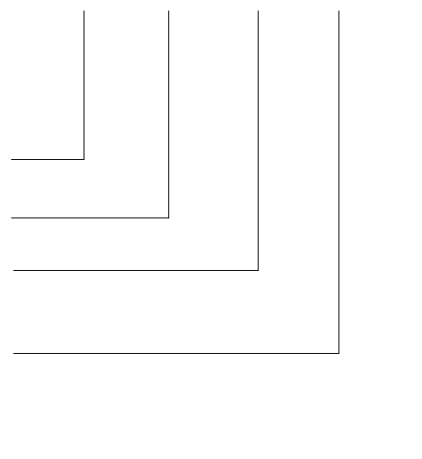

STANDARD DATA XLRnet SERIES



		VALUE
GENERAL CHARACTERISTICS	Termination	Preassembled RJ45 Cable (Not supplied)
	Environmental	Complies with EU RoHS 2 Directive 2011/65/EU
CLIMATIC CHARACTERISTICS	Protection Class	IP40
	Operating Temperature	-25 °C to +75 °C (-13°F to +167°F)
MECHANICAL CHARACTERISTICS	Insertion and Withdrawal force	≥10N - ≤20N
	Weight ²⁾	26g (0.057lb)
	Cable O.D. range	5 or 8mm (0.20" or 0.31")
	Mechanical Operations	1000 mating cycles
MATERIALS	Connector shell - Metal Shell finish	Diecast Zinc Alloy Satin nickel or Black
	Boot / Backshell Finish	UL94V-0 Noryl N190 / Valox Black
	Cable clamp	PA6
	Sleeve	Valox

²⁾ Approximate weight only, does not include packaging. Please contact us for exact weight for shipping purposes.

XLRnet SERIES CABLE ASSEMBLY INSTRUCTIONS

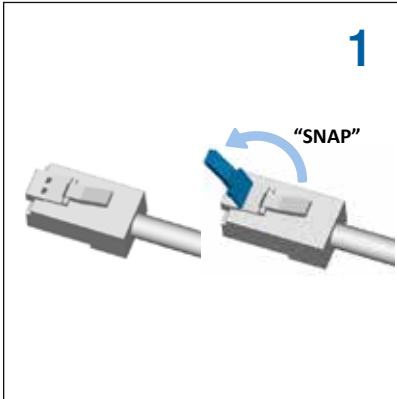

△ Snap or cut off release tab of the RJ45 plug.
Failure to remove the RJ45's Release Tab will make the XLRnet assembly permanently latching. The XLRnet series has an independent panel side latching system.

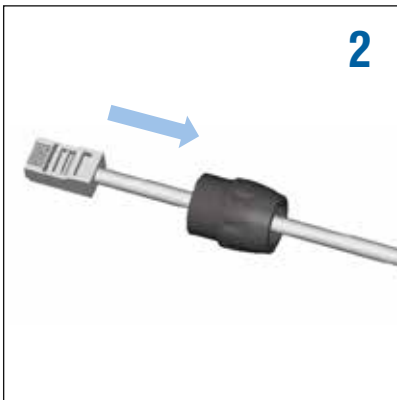

Slide the nut (backshell) onto the cable.

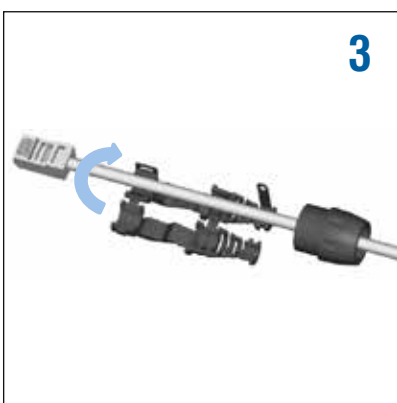

Install the cable clamp-boot.



Close clamp-boot, fasten the two tabs together to lock.



Push clamp-boot & cable together into the shell

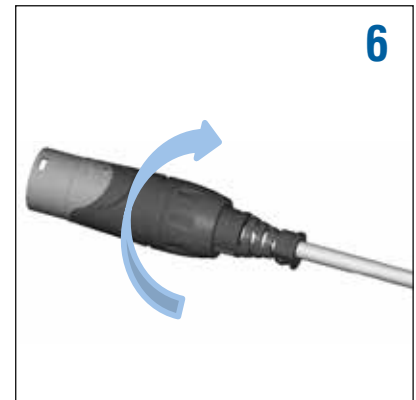

Thread the nut (backshell) onto the shell (torque 0.8Nm-1.2Nm) to close the connector assembly.



Amphenol

XLRnet CHASSIS MOUNT CONNECTORS



Features:

- RJ45 Class D (10/100 BASE-T), CAT5E (1000 BASE-T) or CAT6 (10GBASE-T) Ethernet performance
- A or B type chassis housings
- Shielded or non-shielded
- LED indicators in a variety of colours.
- Horizontal or Vertical PCB
- Mates with XLRnet cable plugs or standard RJ45 plug.

Part Number Breakdown: Page 76

Specifications: Page 80

PCB Footprints: PagePage 79







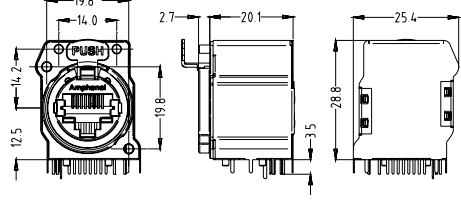

Recommended Fastener: Page 133

PRODUCT - FIGURE	DRAWING	Dimensions in mm (inches)	DESCRIPTION	TYPE	LED* LHS/RHS	PART NUMBER
		19.80 2.7 19.7 24.9 19.80 12.5 19.80 3.5 28.5	XLRnet chassis, A type, Horizontal PCB	Class D	- -	RJX8FA3HB
				CAT5E		RJX8FA5HB
				CAT6		RJX8FA6HB
		19.80 2.7 19.7 24.9 19.80 12.5 19.80 3.5 28.5	XLRnet chassis B type, Horizontal PCB	Class D	- -	RJX8FB3HB
				CAT5E		RJX8FB5HB
				CAT6		RJX8FB6HB
		19.80 2.7 19.7 24.9 14.0 14.2 19.80 12.5 19.80 3.5 28.5	XLRnet chassis, B type, LEDs, Horizontal PCB, Bulk packed	CAT5E	R G	RJX8FB5HRGB
					R Y	RJX8FB5HRYB
					R R	RJX8FB5HRRB
					G R	RJX8FB5HGRB
					G Y	RJX8FB5HGYB
					U U	RJX8FB5HUUB
				CAT6	R G	RJX8FB6HRGB
					R Y	RJX8FB6HRYB
					R R	RJX8FB6HRRB
					G R	RJX8FB6HGRB
G Y	RJX8FB6HGYB					
U U	RJX8FB6HUUB					
		19.80 2.7 20.1 25.4 19.80 12.5 19.80 3.5 28.8	XLRnet chassis, B type, Shielded Hood, Horizontal PCB, Bulk packed	Class D	- -	RJX8FB3HEB
				CAT5E		RJX8FB5HEB
				CAT6		RJX8FB6HEB

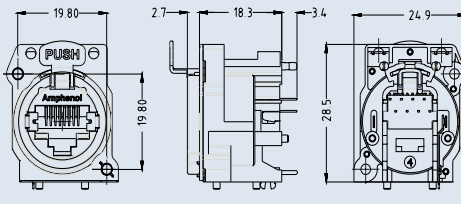
*Note: LED colours are denoted left to right from the panel side front view. Refer page 79
R = Red, G = Green, Y = Yellow, U = Blue

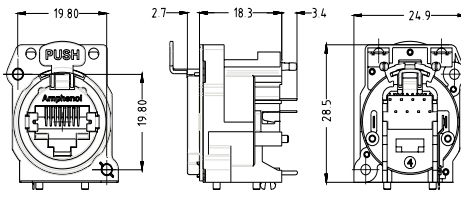

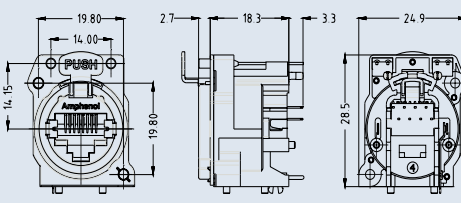
Amphenol

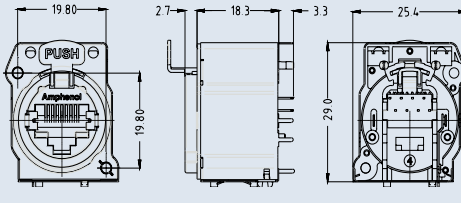
PRODUCT - FIGURE	DRAWING	Dimensions in mm (inches)	DESCRIPTION	TYPE	LED* LHS/RHS	PART NUMBER
			XLRnet chassis, B type, Shielded Hood, LEDs, Horizontal PCB, Bulk packed	CAT5E	R G	RJX8FB5HRGEB
					R Y	RJX8FB5HRYEB
					R R	RJX8FB5HRRREB
					G R	RJX8FB5HGREB
					G Y	RJX8FB5HGYEB
					U U	RJX8FB5HUUEB
				CAT6	R G	RJX8FB6HRGEB
					R Y	RJX8FB6HRYEB
					R R	RJX8FB6HRRREB
					G R	RJX8FB6HGREB
					G Y	RJX8FB6HGYEB
					U U	RJX8FB6HUUEB
			XLRnet chassis, A type, Vertical PCB	Class D	- -	RJX8FA3VB
				CAT5E		RJX8FA5VB
				CAT6		RJX8FA6VB
			XLRnet chassis, B Type, Vertical PCB	Class D	- -	RJX8FB3VB
				CAT5E		RJX8FB5VB
				CAT6		RJX8FB6VB
			XLRnet chassis, B type, LEDs, Vertical PCB, Bulk packed	CAT5E	R G	RJX8FB5VRGB
					R Y	RJX8FB5VRYB
					R R	RJX8FB5VRRB
					G R	RJX8FB5VGRB
					G Y	RJX8FB5VGYB
					U U	RJX8FB5VUUB
				CAT6	R G	RJX8FB6VRGB
					R Y	RJX8FB6VRYB
					R R	RJX8FB6VRRB
					G R	RJX8FB6VGRB
					G Y	RJX8FB6VGYB
					U U	RJX8FB6VUUB
			XLRnet chassis, B type, Shielded Hood, Vertical PCB, Bulk packed	Class D	- -	RJX8FB3VEB
				CAT5E		RJX8FB5VEB
				CAT6		RJX8FB6VEB

*Note: LED colours are denoted left to right from the panel side front view. Refer page 79
R = Red, G = Green, Y = Yellow, U = Blue

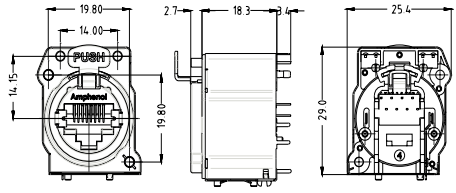
PRODUCT - FIGURE	DRAWING Dimensions in mm (inches)	DESCRIPTION	TYPE	LED* LHS/RHS		PART NUMBER
		XLRnet chassis, B type, Shielded Hood, LEDs, Vertical PCB, Bulk packed	CAT5E	R	G	RJX8FB5VRGEB
				R	Y	RJX8FB5VRYEB
				R	R	RJX8FB5VRREB
				G	R	RJX8FB5VGRGEB
				G	Y	RJX8FB5VGYEB
				U	U	RJX8FB5VUUEB
			CAT6	R	G	RJX8FB6VRGEB
				R	Y	RJX8FB6VRYEB
				R	R	RJX8FB6VRREB
				G	R	RJX8FB6VGRGEB
				G	Y	RJX8FB6VGYEB
				U	U	RJX8FB6VUUEB

*Note: LED colours are denoted left to right from the panel side front view. Refer page 79
R = Red, G = Green, Y = Yellow, U = Blue



PART NUMBER BREAKDOWN

XLRnet A AND B TYPE Printed Circuit Board Connectors

E. G. **RJX8FB5HLRREB**
RJX (Series Prefix), **8** (Contacts), **F**emale **B** type, **5** Cat5E **H**orizontal, Latchless,
Red - Red LEDs, **E**MI / RFI Hood, **B**ulk Packaged.

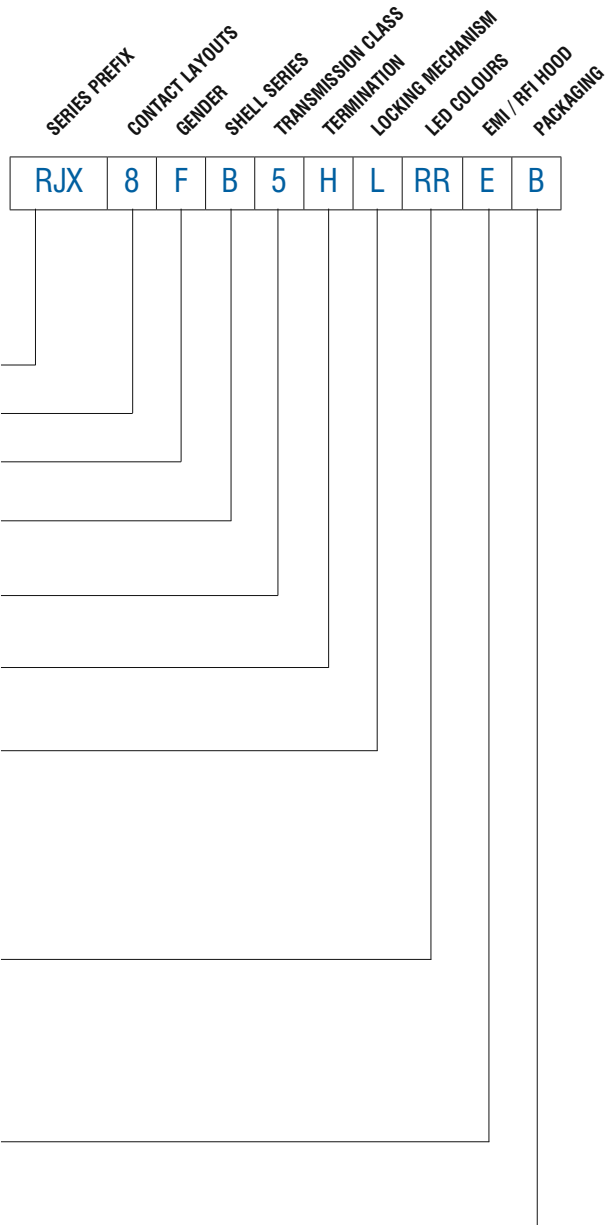

SERIES PREFIX	RJX =	Series Prefix
CONTACT LAYOUT	8 =	RJ45 type
GENDER	F =	Receptacle housing
SHELL SERIES	A = B =	A Type B Type
TRANSMISSION CLASS	3 = 5 = 6 =	Class D CAT 5e CAT 6
TERMINATION	H = V =	Horizontal Printed Circuit Board Vertical Printed Circuit Board
LOCKING MECHANISM	Blank = P =	Latching Push lever supplied separately for customer installation (Contact factory for detailed fitting instructions)
LED COLOUR SEQUENCE*	Blank = RG = RY = RR = GR = GY = GG = YR = YY = YG = UU =	No LEDs Red / Green Red / Yellow Red / Red Green / Red Green / Yellow Green / Green Yellow / Red Yellow / Yellow Yellow / Green Blue / Blue
EMI / RFI SHIELDING HOOD	Blank = E =	No shield hood EMI / RFI shield hood
PACKAGING	Blank = B =	Individual Bulk packed

*Note: LED colours are denoted left to right from the panel side front view.
Refer Page 79



Amphenol

XLRnet CHASSIS CONNECTORS

D TYPE FLANGE



Features:

- RJ45 Class D (10/100 Base-T), CAT5E (1000 Base-T) or CAT6 (10GBASE-T) Ethernet performance
- D type XLR standard housings
- IDC Punchdown block
- Thru-adaptor / Feedthrough
- Horizontal or Vertical PCB

Part Number Breakdown: Page 78

Specifications: Page 80

PCB Footprints: Page 79

Recommended Fastener: Page 133

PRODUCT - FIGURE	DRAWING	Dimensions in mm (inches)	DESCRIPTION	TYPE	PART NUMBER
			XLRnet chassis, D type, Feedthrough, Nickel Finish	CAT5E	RJX8FD5T
				CAT6	RJX8FD6T
			XLRnet chassis, D type, IDC Terminals, 110 type, Nickel Finish	CAT5E	RJX8FD5110
				CAT6	RJX8FD6110
			XLRnet chassis, D type, IDC Terminals, Nickel Finish	CAT5E	RJX8FD5I
				CAT6	RJX8FD6I
			XLRnet chassis, D type, Horizontal PCB, Nickel Finish	Class D	RJX8FD3HB
				CAT5E	RJX8FD5HB
				CAT6	RJX8FD6HB
			XLRnet chassis, D type, Vertical PCB, Nickel Finish	Class D	RJX8FD3VB
				CAT5E	RJX8FD5VB
				CAT6	RJX8FD6VB



PART NUMBER BREAKDOWN

XLRnet D TYPE Chassis Connectors

E. G . **RJX8FD3TB**
RJX (Series Prefix), **8** (Contacts), **F**emale **D** type, **3** Class **D** Thru Adaptor,
Bulk Packaged

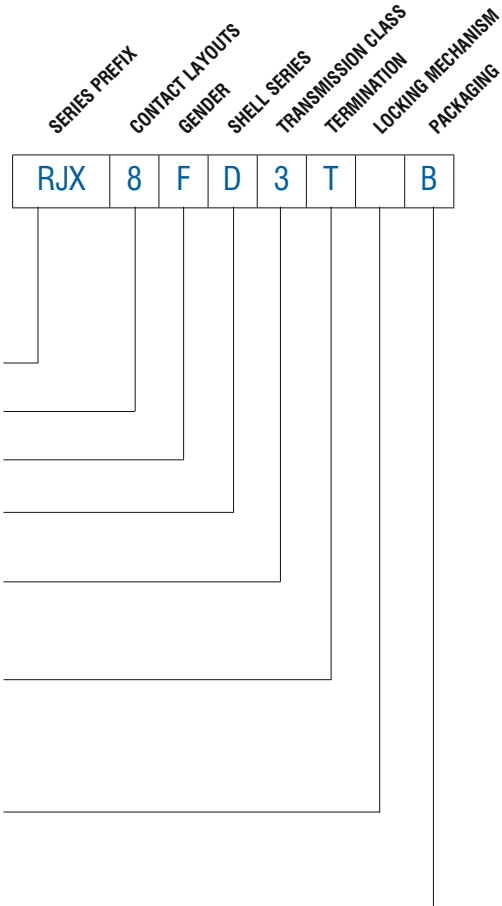

SERIES PREFIX	RJX =	Series Prefix
CONTACT LAYOUT	8 =	RJ45 type
GENDER	F =	Receptacle housing
SHELL SERIES	D =	D Type
TRANSMISSION CLASS	3 = 5 = 6 =	Class D CAT 5e CAT 6
TERMINATION	H = I = 110 = T = V =	Horizontal Printed Circuit Board IDC Punch Down Block IDC 110 Punch Down Block Thru adaptor / Feedthrough Vertical Printed Circuit Board
LOCKING MECHANISM	Blank = P =	Latching Push lever supplied separately for customer installation (Contact factory for detailed fitting instructions)
PACKAGING	Blank = B =	Individual Bulk packed

*Note: LED colours are denoted left to right from the panel side front view.
Refer Page 79



XLrNET A, B AND D TYPE SERIES

* Applicable to 3 (Class D), 5 (CAT5E) and 6 (CAT6), where available

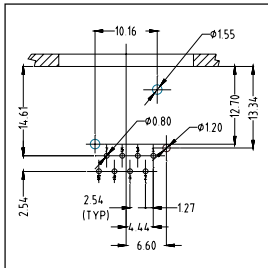

RJX8FA*H
RJX8FA*HB

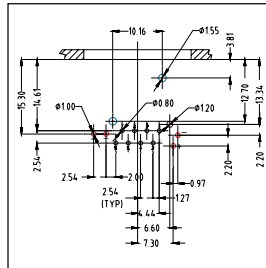

RJX8FB*HRGB
RJX8FB*HRYB
RJX8FB*HRRB
RJX8FB*HGRB
RJX8FB*HGYB
RJX8FB*HGGB

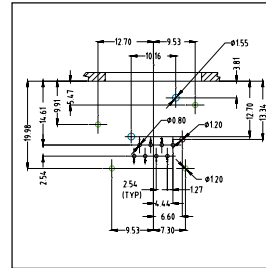

RJX8FB*HEB

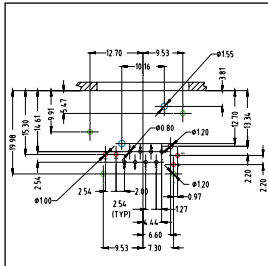

RJX8FB*HRGEB
RJX8FB*HRYEB
RJX8FB*HRRB
RJX8FB*HGREB
RJX8FB*HGYEB
RJX8FB*HGGB

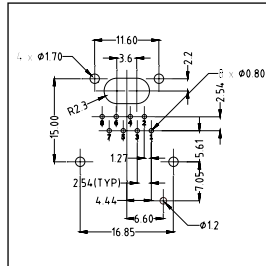

RJX8FA*VB
RJX8FB*VB

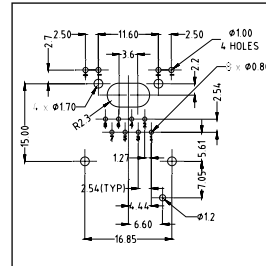

RJX8FB*VRGB
RJX8FB*VRYB
RJX8FB*VRRB
RJX8FB*VGRB
RJX8FB*VGYB
RJX8FB*VUUB

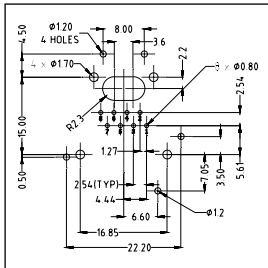

RJX8FB*VEB

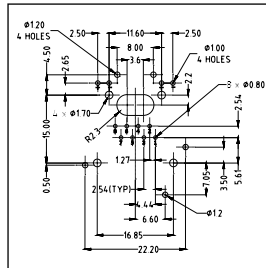

RJX8FB*VRGEB
RJX8FB*VRYEB
RJX8FB*VRRB
RJX8FB*VGREB
RJX8FB*VGYEB
RJX8FB*VUUEB

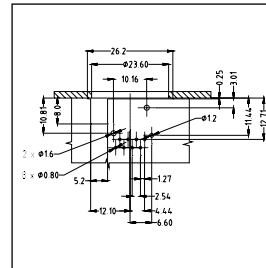

RJX8FD*HB
(Front Mounting)

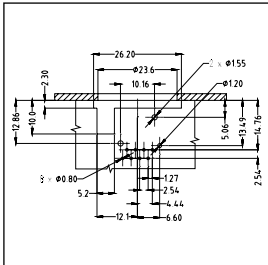

RJX8FD*HB
(Rear Mounting)

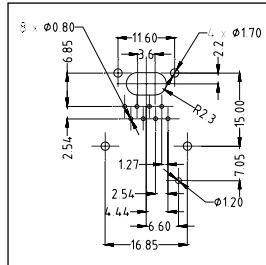

RJX8FD*VB

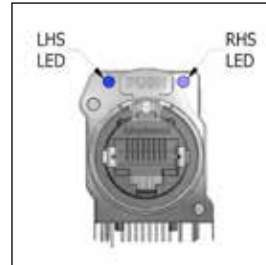

LED Arrangement
(Front view)

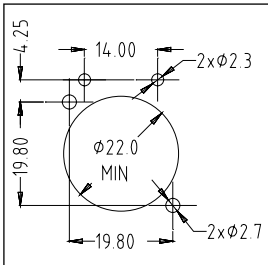

PANEL CUTOUT
A and B type
with LED's

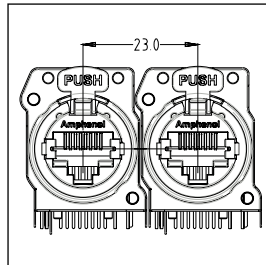

XLrnet
MOUNTING
PITCH /
A and B Type

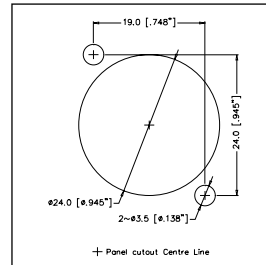

D Type

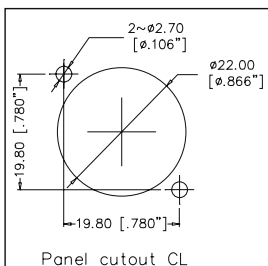

A and B Type



STANDARD DATA XLRnet CHASSIS RECEPTACLES

		VALUE		
		Class D	CAT5E	CAT6
GENERAL CHARACTERISTICS	Number of contacts	8		
	Contact Arrangement	RJ45		
	Termination	Printed Circuit Board (PCB) - through hole, Feedthrough, IDC Terminal		
	Flammability	UL94V-0		
	Environmental	Complies with EU RoHS 2 Directive 2011/65/EU		
	Solderability	MIL-STD 202, Method 208		
ELECTRICAL CHARACTERISTICS	Rated current per contact	1.5 A		
	Rated Voltage	125V AC		
	Typical Contact Resistance	20mΩ		
	Insulation Resistance	> 500MΩ		
	Dielectric Strength	1000 VAC, 60 secs		
	Max. Frequency	100Mhz	250MHz	250MHz
	Ethernet Standard	10/100 BASE-T	1000 BASE-T	10GBASE-T
	Transmission Spec.	EIA/ TIA568-C.2, ISO/IEC 11801, EN50173		
	PoE+	802.3at Type 2		
	LED Type	Round, single pole, indicator		
CLIMATIC CHARACTERISTICS	Protection Class	IP40 (with EMI/RFI shield)		
	Operating Temperature	-40°C to +80°C (-40°F to +176°F)		
MECHANICAL CHARACTERISTICS	Weight** - A & B Housing - Shielded Housing - D Shell	11g (0.024lb) 17g (0.037lb) 25g (0.055lb)		
	Mechanical Operations	1000		
	Insertion and Withdrawal Force	≤ 21N		
	Latch	Spring Steel		
	Panel Thickness max.	3mm		
	Mounting screw torque max.	0.35Nm		
	Fastener	Self-Tapping screw M2.5		
	MATERIALS	Connector Shell / Housing	Thermoplastic, DSM Stanyl UL94V-0, 30% GF / PA66 30% GF	
	Flange (A type)	Thermoplastic, DSM Stanyl UL94V-0, 30% GF		
	Flange (B type)	Diecast Zinc Alloy 3		
	Flange Finish (B type)	Satin Nickel		
	Contact	Phosphor Bronze		
	Contact Finish - Ground - RJ45	0.38μm Au over 1.27μm Ni 1.27μm Au over 1.27μm Ni		
	Metal Hood Shield EMI/RFI	Brass, nickel plated		
	Latch lock and Spring	Spring steel		

Rev 3 - 05/2015

**Approximate weight in grams not including packaging. Please contact us for exact weight for shipping purposes.



BNC 75 RF CONNECTORS

Amphenol offers a complete range of high-performance BNC plugs for use in digital/HD video applications. Amphenol's True 75 Ohm BNC connectors perform well up to and beyond 3GHz and are designed to terminate to a variety of popular coaxial cable types. We can also offer custom connectors to suit non-standard cables on request. Plugs feature a precision machined brass body and coupling nut plated with cost effective nickel plating.

Applications

- Broadcast
- High bandwidth video equipment
- D1/D2 serial digital
- Graphic work stations
- Telephony / Workstations

Options

- Crimp Plugs
- Jack to Jack adapters
- Patch Panels
- 'D' Shell Jacks
- Plug to Plug U-Link connectors
- Crimp Tools

Ordering Codes

We have listed the more common ordering codes in each section. Amphenol offer an extensive range of RF connectors for most applications.

Please visit www.amphenolconnex.com for further information. Please contact us if you need any further assistance.

Simple steps to guide you in using this catalogue



- 1) Identify the product group listed in Contents on page 1 and go directly to that page number.
- 2) Each product group cover page then details information and options available.
- 3) Refer to the product detail pages and identify the product you require pictorially.
- 4) Read the product description column for the products standard features.
- 5) Use variations column to determine your choice.
- 6) Identify part number.
- 7) In the event the particular option you require is not listed please refer to the part number breakdown page at the end of each section.
- 8) Please contact us directly if you have any further problems.



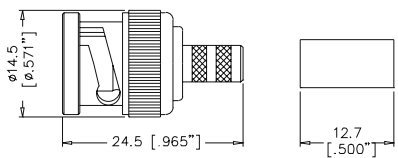
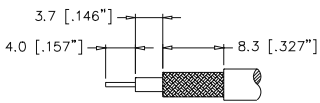

Amphenol manufactures a large range of connectors to suit cables other than those listed below, for example Belden YR23769 and 46899, please contact us to discuss your specific requirements.

The complete Amphenol Connex catalogue featuring a wide range of RF connector products is available on request. Item code CAT-CONNEX-01.

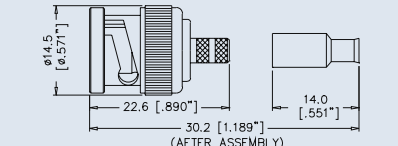
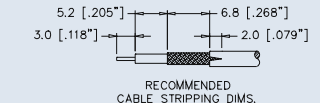
PRODUCT - FIGURE	DRAWING Dimensions in mm (inches)	CABLE TYPE RG-/U	INSULATION	CRIMP TOOL	PART NUMBER	
   <p>RECOMMENDED CABLE STRIPPING DIMS.</p> <p>Assembly Instruction A - page 89</p>	Straight Crimp Plug - Captive Contact- Standard Cable	59/ 62/ 140/ 210	Delrin	A	112119	
			Teflon	E	112952*	
			59/ U-20AWG	Delrin	A	112507
				Teflon	E	112956*
			11/ U-14AWG/ B8213/ B9292/ B7731/ B1859A	Teflon	D	112606
			6/ 143/ 212	Delrin	E	112508
			B1694A/ B9248	Delrin	E	112565
				Teflon	E	112957*
			6 PLENUM/ B1695A	Delrin	E	112519
			B8281/ B9231/ B9141	Delrin	E	112509
				Teflon	E	112953*
			B1505A	Teflon	E	112951*
		B735A1	Teflon	F	112950*	
   <p>RECOMMENDED CABLE STRIPPING DIMS.</p> <p>Assembly Instruction B - page 89</p>	Straight Crimp Plug-Captive Contact-Miniature Cable (Remark: With Teflon sleeve / Hex crimp size .178")	179/ 187/ B9221	Delrin	B	112133	
			180/ 195/ 122/ B8218/ B1865A/ B1855	Delrin	B	112521
				Teflon	F	112955*

Note: *True 75 ohm.



Features:

- Amphenol True 75 Ohm Connectors
- Bayonet lock or Push-on types
- Supplied with adhesive strip ID labels

Options:

- 1RU, 20 BNC connectors or 2RU, 40 BNC connectors
- Aluminium in Clear or Black anodised
- Steel in Black powder coat
- Customised versions available on request

PRODUCT - FIGURE DRAWING	Dimensions in mm (inches)	DESCRIPTION	MATERIAL / FINISH	LOADED WITH <small>(refer to page 84 for specifications)</small>	PART NUMBER
	482 [18.976"] 464.5 [18.287"] TYP 20.50 [.807"] TYP 44 [1.732"] 32.3 [1.272"] TYP 13.70 [.539"] TYP 32.6 [1.283"] TYP	1RU 1X20 Patch Panel, Supplied with 1 ID label	Steel / Black	Empty Panel	AC-BNC20M
		Steel / Black	AC-BNC-JJA-75	AC-BNC20MJ75	
		Steel / Black	AC-BNC-PJA-75	AC-BNC20MP75	
		Aluminium / Clear	Empty Panel	AC-BNC20A	
		Aluminium / Clear	AC-BNC-JJA-75	AC-BNC20AJ75	
		Aluminium / Clear	AC-BNC-PJA-75	AC-BNC20AP75	
		Aluminium / Black	Empty Panel	AC-BNC20B	
		Aluminium / Black	AC-BNC-JJA-75	AC-BNC20BJ75	
		Aluminium / Black	AC-BNC-PJA-75	AC-BNC20BP75	
	482 [18.976"] 464.5 [18.287"] TYP 20.50 [.807"] TYP 76.3 [3.004"] TYP 88 [3.465"] 13.70 [.539"] TYP 32.6 [1.283"] TYP	2RU 2X20 Patch Panel, Supplied with 2 ID labels	Steel / Black	Empty Panel	AC-BNC40M
		Steel / Black	AC-BNC-JJA-75	AC-BNC40MJ75	
		Steel / Black	AC-BNC-PJA-75	AC-BNC40MP75	
		Aluminium / Clear	Empty Panel	AC-BNC40A	
		Aluminium / Clear	AC-BNC-JJA-75	AC-BNC40AJ75	
		Aluminium / Clear	AC-BNC-PJA-75	AC-BNC40AP75	
		Aluminium / Black	Empty Panel	AC-BNC40B	
		Aluminium / Black	AC-BNC-JJA-75	AC-BNC40BJ75	
		Aluminium / Black	AC-BNC-PJA-75	AC-BNC40BP75	
Panel ID label	Plastic	Not Applicable	AC-BNC-LABEL		



BNC 75 RF ASSEMBLY INSTRUCTIONS

ASSEMBLY A

STEP 1

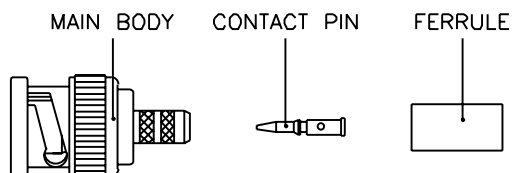

STEP 2

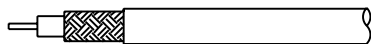

STEP 3

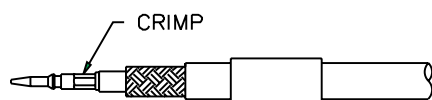

STEP 4

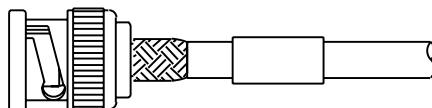

STEP 5

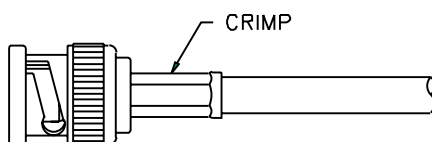

STEP 1. All parts of the connector are shown. A crimp tool is necessary to complete the connection.

STEP 2. Strip the cable inner conductor, dielectric, braid, and jacket as per "RECOMMENDED CABLE STRIPPING DIM'S" in catalogue.

STEP 3. Insert inner conductor into the CONTACT PIN, crimp it with the crimp tool as shown. Then slide the FERRULE onto cable.

STEP 4. Insert the MAIN BODY into braid and dielectric.

STEP 5. Slide the FERRULE over braid, crimp it with the crimp tool as shown.

ASSEMBLY B

STEP 1

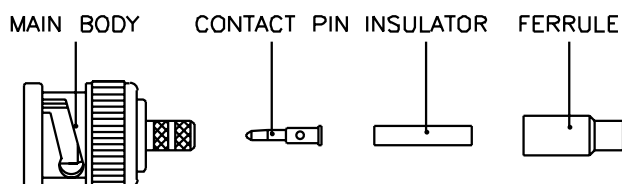

STEP 2

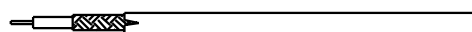

STEP 3

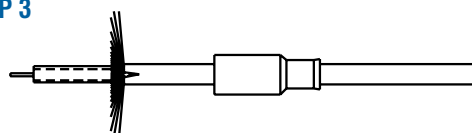

STEP 4

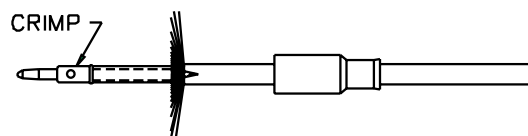

STEP 5

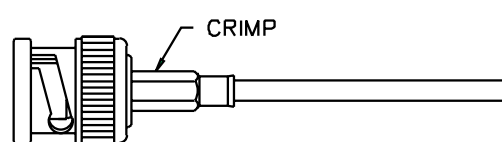

STEP 1. All parts of the connector are shown. A crimp tool is necessary to complete the connection.

STEP 2. Strip the inner conductor, dielectric, and jacket as per "RECOMMENDED CABLE STRIPPING DIM'S" in catalogue.

STEP 3. Slide the FERRULE on to cable, then fold back braid wire and slide the INSULATOR on to dielectric as shown.

STEP 4. Insert inner conductor into the CONTACT PIN, crimp it with crimp tool as shown.

STEP 5. Push cable and parts into the MAIN BODY until it stops. Then slide the FERRULE over braid wire and against the MAIN BODY, crimp it with the crimp tool as shown.



STANDARD DATA BNC 75 RF CONNECTORS

		VALUE	
GENERAL CHARACTERISTICS	Mating	Bayonet Lock	
	Cable Attachment	Crimp - Crimp	
	Environmental	Complies with EU RoHS 2 Directive 2011/65/EU	
ELECTRICAL CHARACTERISTICS	Impedance	75Ω	
	Frequency Range - Standard	0 - 1 GHz	
	- True 75 Ohm	0 - 4 GHz	
	Voltage Rating	500V RMS	
	Dielectric withstanding voltage	1500 Volts RMS	
	VSWR - Standard	1.05+0.1f(GHz) DC to 1 GHz	
	- True 75 Ohm	1.5+0.1f(GHz) DC to 4 GHz	
	Contact Resistance		
Centre Contact	1.5 milliohm		
Outer Contact	1.0 milliohm		
Insulation Resistance	5000 MΩ (min.)		
MATERIALS	Part	Material	Finish
	Body, Coupling sleeves	Brass	Nickel
	Crimp Ferrule	Annealed Copper	Nickel
	Male Contact	Brass	Gold
	Female Contact	Beryllium Copper or Phosphor Bronze	Gold
	XLR Housing	Diecast Zinc Alloy	Satin Nickel or Black Polyester
	Insulators	Teflon or Delrin	Natural

NOTE: These characteristics are typical and may not apply to all connectors.

PANEL CUTOUTS - FRONT VIEW

AC-BNC-PJ-75
AC-BNC-JJ-75

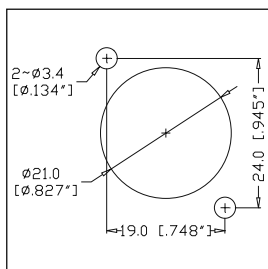

AC-BNC-PJA-75
AC-BNC-JJA-75

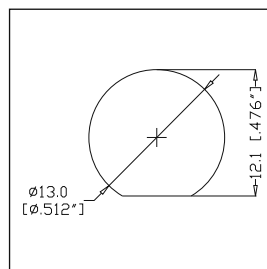

Rev 4 - 03/2013



1/4" PHONE CONNECTORS

Amphenol offers two ranges of 1/4" Phone plug connectors to satisfy the needs of the manufacturer and the end user. The PRO – a heavy duty on-road plug and the MUSICIAN - a solid performing general use plug. Both series offer different features and benefits and the most suitable type will be determined by application, budget and personal choice.

Applications

- Audio Cables and Snakes
- Amplifiers
- Speakers
- Mixing desks
- Rack mount equipment
- Patch panel

Features / Options – PRO RANGE 1/4" Phone Plug T-Series.

- Mono or Stereo (TRS)
- Switching Plugs
- Stylised shell design with Ergonomic grip
- Nickel or Gold contact plating
- Straight or Right Angle
- Keyed Shell
- Optional heavy duty metal backshell / boot
- Great solderability
- Increased solder area on ground contact
- "Jaws" Cable Clamp
- Precision machined contacts
- Coloured Grommet
- JUMBO Series Plugs

Features / Options – MUSICIAN RANGE 1/4" Phone Plug

- Mono or Stereo (TRS)
- Compact Shell
- Straight or Right angle
- Stylish shell design
- Flexible grommet cable protection
- Nickel or Gold contact plating
- Satin Nickel or Black finish
- Diecast shell
- Coloured Grommet

Jaws Cable Clamp Options for T-Series*



Standard Jaws cable clamp (Black), Cable O.D 3mm to 6mm (0.118" to 0.236")



Large Jaws cable clamp (Purple), Cable O.D 6mm to 7mm (0.236" to 0.275")

*Note: Applicable to T-Series straight cable connectors only. Refer to page 95 for right angle connector Jaws cable clamp specifications.

Musician Range Cable Clamp Options



M-Series, Cable O.D 3mm to 6.5mm (0.118" to 0.256")



M-Series II, Cable O.D 6.5mm to 8mm (0.256" to 0.315")

Ordering Codes

We have listed the more common ordering codes in each section. Refer to our 1/4" plug product feature matrix found on the next page for assistance on selecting the right plug for your application.

Simple steps to guide you in using this catalogue

- 1) Identify the product group listed in Contents on page 1 and go directly to that page number.
- 2) Each product group cover page then details information and options available.
- 3) Refer to the product detail pages and identify the product you require pictorially.
- 4) Read the product description column for the products standard features.
- 5) Use variations column to determine your choice.
- 6) Identify part number.
- 7) In the event the particular option you require is not listed please refer to the part number breakdown page at the end of each section.
- 8) Please contact us directly if you have any further problems.



1/4" PLUG FEATURE MATRIX

FEATURES		T SERIES (STRAIGHT)	T SERIES (RIGHT ANGLE)	JUMBO T SERIES	SWITCHPLUG T SERIES (STRAIGHT)	SWITCHPLUG T SERIES (RIGHT ANGLE)	M SERIES	M SERIES II	CUSTOM SERIES ¹
PRECISION MACHINED CONTACTS		X	X	X	X	X	X	X	X
CENTER CONTACT	1 pc. Center Contact	X	X	X	X	X			X*
	2 pc Press Fit Tip/Center Contact					X	X		X*
BARREL:	Machined Tube	X	X	X	X	X			
	Precision Extruded Tube					X	X		X
JAWS CABLE CLAMP		X	X		X	X			
MIN. CABLE OD	Black Jaw: 3mm/0.118"	X	X		X	X			
	Purple Jaw: 6mm/0.236"	X			X				
	Purple Jaw: 5.5mm/0.216"		X			X			
MAX. CABLE OD	Black Jaw: 6mm/0.236"	X			X				
	Black Jaw: 5.5mm/0.216"		X			X			
	Purple Jaw: 7.5mm/0.295"	X			X				
	Purple Jaw: 6.5mm/0.255"		X			X			
STANDARD CABLE CLAMP				X			X	X	X
MIN. CABLE OD	7.5mm/0.295"			X					
MAX. CABLE OD	6mm/0.236"						X		
	8mm/0.315"							X	
	8.8mm/0.345"								X
	10.5mm/0.413"			X					
BACKSHELL FINISH	Satin Nickel	X	X	X	X	X	X	X	
	Black	X	X	X	X	X	X	X	
	Bright Nickel								X
	Bright Gold								X
CONTACT MATERIAL/ FINISH OPTIONS	Brass/Nickel (Ni)	X	X	X	X	X	X	X	X
	Brass/Gold over 2µm (Ni)	X	X	X	X	X	X	X	X

¹Custom Series - Minimum order quantities apply. Contact us for further details.







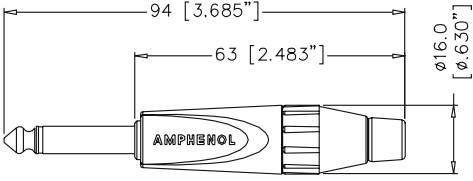

Features:

- Mono or Stereo (TRS).
- Stylised shell design with Ergonomic grip.
- Straight or Right Angle.
- Robust diecast shell in Satin nickel or Black finish.
- Nickel or Gold contact plating.
- Keyed shell.
- Optional heavy duty metal backshell / boot.
- Great solderability.
- Increased solder area on ground contact.
- "Jaws" Cable Clamp.
- Precision machined contacts.
- Quick and easy assembly.

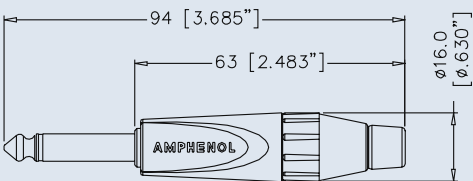
Options: Gold Contacts, Large or Small Jaws Cable Clamp, Black Shell, Metal Backshell / Boot, Bulk Pack. Coloured grommets (ordered separately)

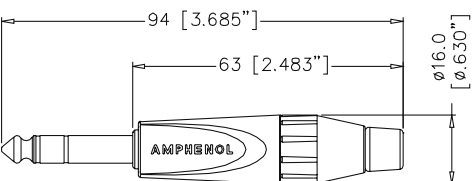
Part Number Breakdown: Page 97 Specifications: Page 98

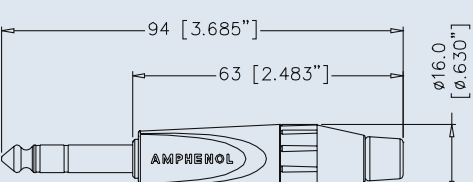
PRODUCT - FIGURE	DRAWING	DESCRIPTION	VARIATIONS	PART NUMBER
		1/4" (6.35mmø) Mono Phone plug, Jaws cable clamp, Thermoplastic back- shell, Satin finish.	Standard	TM2P
			Gold Plated Contacts	TM2P-AU
			Large Cable Clamp	TM2PJ
			Bulk Pack	TM2P BULK
		1/4" (6.35mmø) Mono Phone plug, Jaws cable clamp, Thermoplastic back- shell, Black finish.	Standard	TM2PB
			Gold Plated Contacts	TM2PB-AU
			Large Cable Clamp	TM2PBJ
			Bulk Pack	TM2PB BULK
		1/4" (6.35mmø) Stereo Phone plug, Jaws cable clamp, Thermoplastic back- shell, Satin finish.	Standard	TS3P
			Gold Plated Contacts	TS3P-AU
			Large Cable Clamp	TS3PJ
			Bulk Pack	TS3P BULK
		1/4" (6.35mmø) Stereo Phone plug, Jaws cable clamp, Thermoplastic back- shell, Black finish.	Standard	TS3PB
			Gold Plated Contacts	TS3PB-AU
			Large Cable Clamp	TS3PBJ
			Bulk Pack	TS3PB BULK



Amphenol



1/4" PHONE PLUGS

T-SERIES (PRO RANGE)

PRODUCT - FIGURE	DRAWING	DESCRIPTION	VARIATIONS	PART NUMBER
		1/4" (6.35mmø) Mono Phone plug, Jaws cable clamp, Metal backshell, Satin finish.	Standard Gold Plated Contacts Large Cable Clamp Bulk Pack	TM2PN TM2PN-AU TM2PNJ TM2PN BULK
		1/4" (6.35mmø) Mono Phone plug, Jaws cable clamp, Metal backshell, Black finish.	Standard Gold Plated Contacts Large Cable Clamp Bulk Pack	TM2PBM TM2PBM-AU TM2PBMJ TM2PBM BULK
		1/4" (6.35mmø) Stereo Phone plug, Jaws cable clamp, Metal backshell, Satin finish.	Standard Gold Plated Contacts Large Cable Clamp Bulk Pack	TS3PN TS3PN-AU TS3PNJ TS3PN BULK
		1/4" (6.35mmø) Stereo Phone plug, Jaws cable clamp, Metal backshell, Black finish.	Standard Gold Plated Contacts Large Cable Clamp Bulk Pack	TS3PBM TS3PBM-AU TS3PBMJ TS3PBM BULK
		1/4" (6.35mmø) Mono Phone plug, Right angle, Jaws cable clamp*, Thermoplastic backshell, Satin finish.	Standard Gold Plated Contacts Small Cable Clamp Bulk Pack	TM2RJ TM2RJ-AU TM2R TM2RJ BULK
		1/4" (6.35mmø) Mono Phone plug, Right angle, Jaws cable clamp*, Thermoplastic backshell, Black finish.	Standard Gold Plated Contacts Small Cable Clamp Bulk Pack	TM2RBJ TM2RBJ-AU TM2RB TM2RBJ BULK
		1/4" (6.35mmø) Stereo Phone plug, Right angle, Jaws cable clamp*, Thermoplastic backshell, Satin finish.	Standard Gold Plated Contacts Small Cable Clamp Bulk Pack	TS3RJ TS3RJ-AU TS3R TS3RJ BULK
		1/4" (6.35mmø) Stereo Phone plug, Right angle, Jaws cable clamp*, Thermoplastic backshell, Black finish.	Standard Gold Plated Contacts Small Cable Clamp Bulk Pack	TS3RBJ TS3RBJ-AU TS3RB TS3RBJ BULK

*NOTE: Refer to page 95 for Jaws cable clamp specifications applicable to right angle connectors.



The Amphenol T series SwitchPlug uses a unique 360 degree precision sliding helical spring contact design to quietly and accurately switch the signal circuit safely to ground during instrument changes under load, thereby avoiding annoying thumps, pops and squeals. The sliding ring contact self-cleans every time the plug is connected preventing excessive build up of oxidization and contamination. Activation is directly off the jacks full front face assuring a positive reference point every time, and as it works instantaneously on the main circuits there is no need for the use of magnets or other elaborate switching mechanisms.

WARNING!
For use with
instrument (guitar)
applications only.

Part Number Breakdown: Page 94
Specifications: Page 95

US Patent No.8,162,697

PRODUCT - FIGURE	DRAWING	Dimensions in mm (inches)	DESCRIPTION	VARIATIONS	PART NUMBER
			1/4" (6.35mmø) Switch Phone plug, Jaws cable clamp, Thermoplastic backshell, Satin finish	Standard Gold Plated Contacts Large Cable Clamp Bulk Pack	TM1P TM1P-AU TM1PJ TM1P BULK
			1/4" (6.35mmø) Switch Phone plug, Jaws cable clamp, Thermoplastic backshell, Black finish	Standard Gold Plated Contacts Large Cable Clamp Bulk Pack	TM1PB TM1PB-AU TM1PBJ TM1PB BULK
			1/4" (6.35mmø) Switch Phone plug, Right angle, Jaws cable clamp*, Thermoplastic backshell, Satin Finish	Standard Gold Plated Contacts Bulk Pack	TM1RJ* TM1RJ-AU* TM1RJ BULK*
			1/4" (6.35mmø) Switch Phone plug, Right angle, Jaws cable clamp*, Thermoplastic backshell, Black Finish	Standard Gold Plated Contacts Bulk Pack	TM1RBJ* TM1RBJ-AU* TM1RBJ BULK*

*NOTE: Refer to page 98 for Jaws cable clamp specifications applicable to right angle connectors.



Amphenol

SwitchPlug - User Instruction

CAUTION!  Use with instrument (guitar) cables only. DO NOT connect to amplifier output. Equipment damage may result from incorrect use.

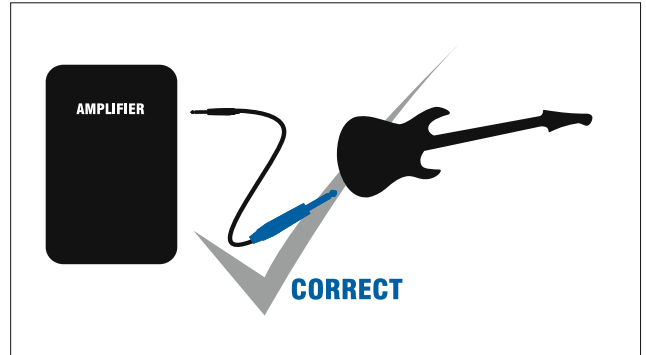
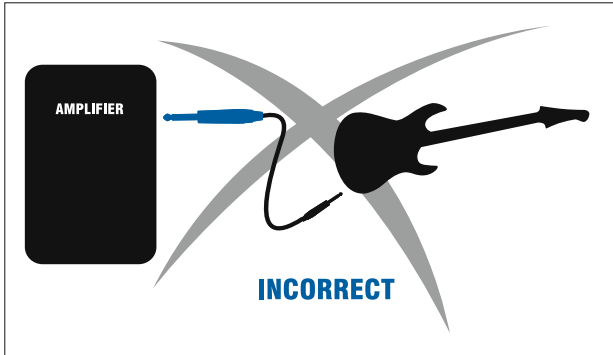

SwitchPlug - Technology*

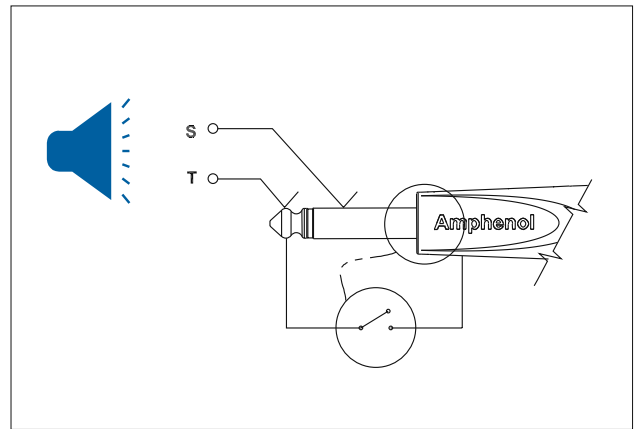
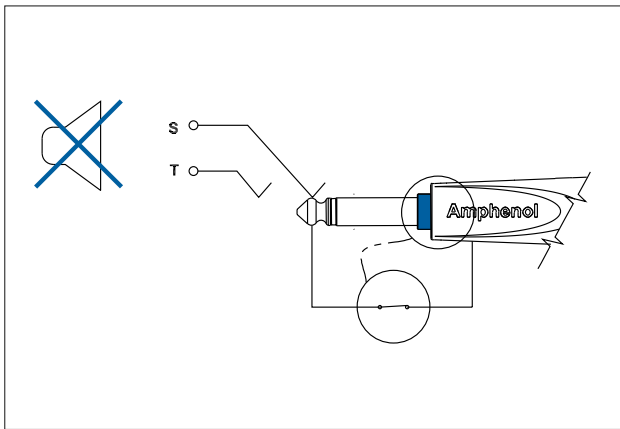

*US Patent No. 8,162,697



Features:

- JUMBO Cable clamping capacity
- Suits Cable OD 7.5mm (0.295") to 10.5mm (0.413")
- Mono or Stereo (TRS).
- Stylised shell design with Ergonomic grip.
- Robust diecast shell in Satin nickel or Black finish.
- Nickel or Gold contact plating.
- Keyed shell.
- Great solderability.
- Increased solder area on ground contact.
- Precision machined contacts.
- Quick and easy assembly.

Options: Gold Contacts, Bulk Pack.

Specifications: Page 95

PRODUCT - FIGURE	DRAWING	DESCRIPTION	VARIATIONS	PART NUMBER
		1/4" (6.35mm \varnothing) JUMBO Mono Phone plug, Thermoplastic back- shell, Satin finish.	Standard Gold Plated Contacts Bulk Pack	JM2P JM2P-AU JM2P BULK
		1/4" (6.35mm \varnothing) JUMBO Mono Phone plug, Thermoplastic back- shell, Black finish.	Standard Gold Plated Contacts Bulk Pack	JM2PB JM2PB-AU JM2PB BULK
		1/4" (6.35mm \varnothing) JUMBO Stereo Phone plug, Thermoplastic back- shell, Satin finish.	Standard Gold Plated Contacts Bulk Pack	JS3P JS3P-AU JS3P BULK
		1/4" (6.35mm \varnothing) JUMBO Stereo Phone plug, Thermoplastic back- shell, Black finish.	Standard Gold Plated Contacts Bulk Pack	JS3PB JS3PB-AU JS3P BULK

NOTE: Contact factory for availability of metal backshells.



Amphenol

PART NUMBER BREAKDOWN

T-SERIES (PRO RANGE)

E. G. **TS3PBMJ-AU BULK**
T (Series Prefix), **S3** (Stereo), **P** (Plug Black), **M** (Metal Nut (Black)), **J** (Large Jaws),
- AU (Gold Plated Contacts), **BULK** Packaged.

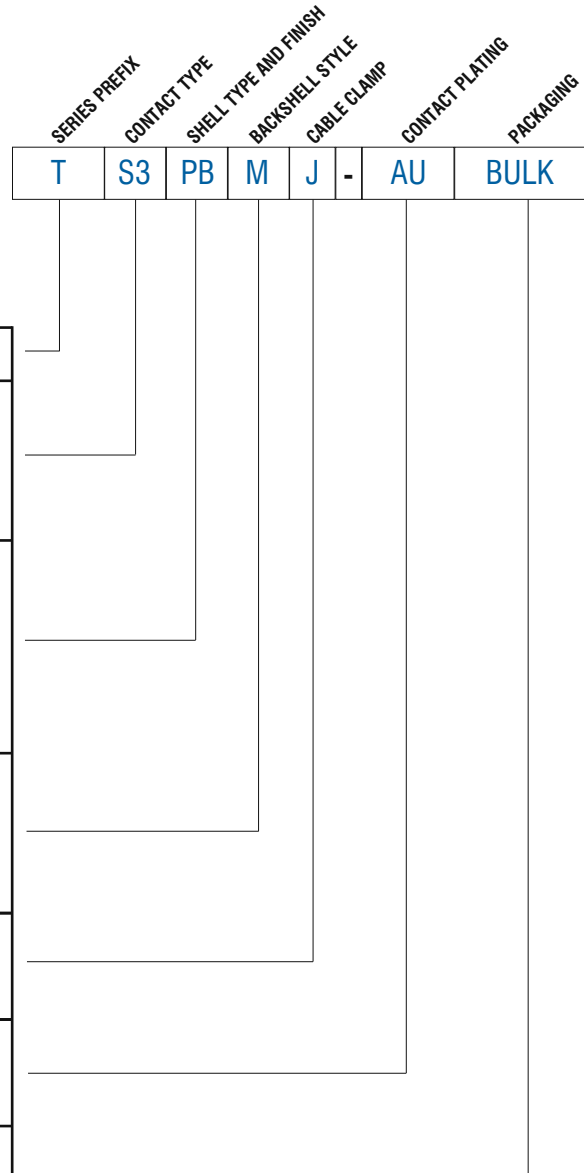

SERIES PREFIX	T	=	Series Prefix
CONTACT TYPE	M1	=	Switch Plug
	M2	=	2 Pole (mono)
	S3	=	3 Pole, tip/ring/sleeve (stereo)
SHELL TYPE AND FINISH	P	=	Plug Satin Nickel
	PB	=	Plug Matt Black
	R	=	Right Angle Plug Satin Nickel
	RB	=	Right Angle Plug Matt Black
BACKSHELL TYPE	Blank	=	Plastic Nut
	M	=	Metal Nut - Black
	N	=	Metal Nut - Satin Nickel
CABLE CLAMP	Blank	=	Small Jaws
	J	=	Large Jaws
CONTACT PLATING	Blank	=	Nickel Plated Contacts (Standard)
	AU	=	Gold Plated Contacts
PACKAGING	Blank	=	Individual Bags
	BULK	=	Bulk Packed

ISO VIEW OF TM2P

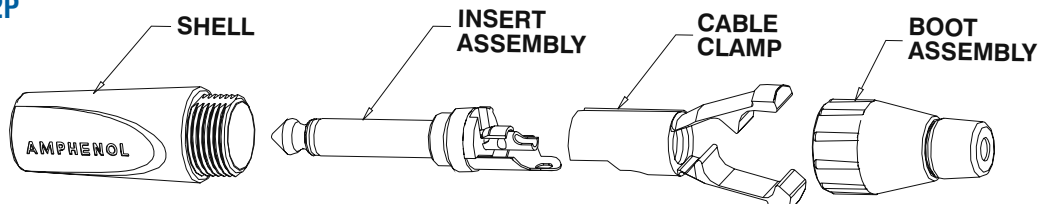

1/4" PHONE PLUG TECHNICAL DATA

		VALUE		
		Straight	Right Angle	Jumbo
GENERAL CHARACTERISTICS	Number of Contacts	3 Pole Tip Ring Sleeve (Stereo)		
	Termination	Solder		
	Max. Wire Gauge - Stranded Wire	2 Pole (Mono): AWG 16 - 1.5mm ² 3 Pole (Stereo): AWG 18 - 1mm ²		
	Flammability rating of insulating plastics	UL94V-0		
	Solderability, complies with	IEC 68-2-20		
	Environmental	Complies with EU RoHS 2 Directive 2011/65/EU		
ELECTRICAL CHARACTERISTICS	Current Carrying Capacity	10A (Depends on Mating Connector and Cable)		
	Typical Contact Resistance	Depends on Mating Connector		
	Insulation resistance (initial)	>2GΩ		
	After Damp Heat Test	≥1GΩ		
	Dielectric Withstand Voltage	2 Pole : 1.5 kV dc 3 Pole : 1 kV dc		
CLIMATIC CHARACTERISTICS	Protection Class	IP40		
	Operating Temperature	-25°C to +75°C (-13°F to + 167°F)		
MECHANICAL CHARACTERISTICS	Insertion and Withdrawal Force	≥10N - ≤30N		
	Weight ¹⁾ - Thermoplastic Backshell	28g (0.061lb)		
	Weight ¹⁾ - Metal Backshell	35g (0.077lb)		
	Typical Cable Retention Force	22kg to 44kg (50lb to 100lb) - Dependent on cable material and diameter.		
	Cable O.D. - Standard Jaw	3mm to 6mm (0.118" to 0.236")	3mm to 5.5mm (0.118" to 0.216")	NA
	Cable O.D. - Large Jaw	6mm to 7mm (0.236" to 0.275")	5.5mm to 6.5mm (0.216" to 0.255")	NA
	Cable O.D. - Jumbo	NA	NA	7.5mm to 10.5mm (0.295" to 0.413")
	Mechanical Operations	1000		
MATERIALS	Connector Shell Material	Diecast Zinc Alloy EZDA No.3		
	Shell Finish	Satin Nickel or Black Polyester		
	Insulators	UL94 V-0 PBT Resin or Modified PPE Resin - Black		
	Boot / Backshell	UL94 V-0 PBT Resin or Modified PPE Resin - Black or Metal CuZn ³⁹ Pb ³		
	Cable Clamp	UL94 V-0 PBT Modified PPO Resin - Black		
	Cable Bushing	Santoprene		
	Contacts / Plating	Brass/Ni or Au over 2μm Ni		

Rev 5 - 03/2013

¹⁾ Approximate weight only, does not include packaging. Please contact us for exact weight for shipping purposes.





Features:

- Mono or Stereo (TRS).
- AX Series inspired shell design.
- Large cable O.D. Entry to 8mm (0.315")
- Robust diecast shell in Satin nickel or Black finish.
- Nickel or Gold contact plating.
- Flexible grommet cable protection.
- Improved solderability.
- Precision machined contacts.
- Standard or Bulk packaging.

Clamp Info:









Cable O.D 6.5mm to 8mm (0.256" to 0.315")

Options: Black Shell, Gold contacts. Coloured grommets (ordered separately)

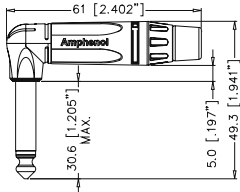
Specifications: Page 112

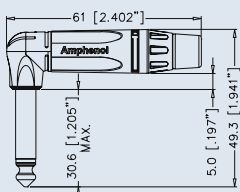
PRODUCT - FIGURE	DRAWING	DESCRIPTION	VARIATIONS	PART NUMBER
		1/4" (6.35mmø) Mono Phone plug, Diecast Shell, Satin finish, Flexible grommet.	Standard	ACPM-KN
			Gold Plated Contacts	ACPM-KN-AU
			Bulk Pack	ACPM-KN-BULK
		1/4" (6.35mmø) Mono Phone plug, Diecast Shell, Black finish, Flexible grommet.	Standard	ACPM-KB
			Gold Plated Contacts	ACPM-KB-AU
			Bulk Pack	ACPM-KB BULK
		1/4" (6.35mmø) Stereo Phone plug, Diecast Shell, Satin finish, Flexible grommet.	Standard	ACPS-KN
			Gold Plated Contacts	ACPS-KN-AU
			Bulk Pack	ACPS-KN BULK
		1/4" (6.35mmø) Stereo Phone plug, Diecast Shell, Black finish, Flexible grommet.	Standard	ACPS-KB
			Gold Plated Contacts	ACPS-KB-AU
			Bulk Pack	ACPS-KB BULK

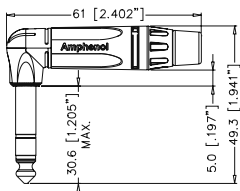

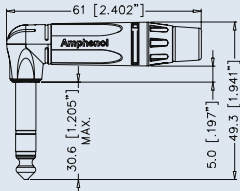
PRODUCT - FIGURE	DRAWING	Dimensions in mm (inches)	DESCRIPTION	VARIATIONS	PART NUMBER
			1/4" (6.35mmø) Mono Phone plug, Right angle, Diecast Shell, Satin finish, Flexible grommet.	Standard	ACPM-TN
				Gold Contacts	ACPM-TN-AU
				Bulk Pack	ACPM-TN BULK
			1/4" (6.35mmø) Mono Phone plug, Right angle, Diecast Shell, Black finish, Flexible grommet.	Standard	ACPM-TB
				Gold Contacts	ACPM-TB-AU
				Bulk Pack	ACPM-TB BULK
			1/4" (6.35mmø) Stereo Phone plug, Right angle, Diecast Shell, Satin finish, Flexible grommet.	Standard	ACPS-TN
				Gold Contacts	ACPS-TN-AU
				Bulk Pack	ACPS-TN BULK
			1/4" (6.35mmø) Stereo Phone plug, Right angle, Diecast Shell, Black finish, Flexible grommet.	Standard	ACPS-TB
				Gold Contacts	ACPS-TB-AU
				Bulk Pack	ACPS-TB BULK





Features:

- Mono or Stereo (TRS).
- Stylish shell design.
- Robust diecast shell in Satin nickel or Black finish.
- Nickel or Gold contact plating.
- Flexible grommet cable protection.
- Improved solderability.
- Precision machined contacts.
- Standard or Bulk packaging.
- Cable OD Entry to 6.5mm (0.256")

Clamp Info:







Cable O.D 3mm to 6.5mm (0.118" to 0.256")

Options: Black Shell, Gold contacts.
Coloured grommets (ordered separately)

Specifications: Page 109

PRODUCT - FIGURE	DRAWING	DESCRIPTION	VARIATIONS	PART NUMBER
	<p>Dimensions in mm (inches)</p>	1/4" (6.35mmø) Mono Phone plug, Diecast Shell, Satin finish, Flexible grommet.	Standard Gold Plated Contacts Bulk Pack	ACPM-GN ACPM-GN-AU ACPM-GN BULK
		1/4" (6.35mmø) Mono Phone plug, Diecast Shell, Black finish, Flexible grommet.	Standard Gold Plated Contacts Bulk Pack	ACPM-GB ACPM-GB-AU ACPM-GB BULK
		1/4" (6.35mmø) Stereo Phone plug, Diecast Shell, Satin finish, Flexible grommet.	Standard Gold Plated Contacts Bulk Pack	ACPS-GN ACPS-GN-AU ACPS-GN BULK
		1/4" (6.35mmø) Stereo Phone plug, Diecast Shell, Black finish, Flexible grommet.	Standard Gold Plated Contacts Bulk Pack	ACPS-GB ACPS-GB-AU ACPS-GB BULK



PRODUCT - FIGURE	DRAWING	DESCRIPTION	TYPE	PART NUMBER
		<p>1/4" (6.35mmø) Mono Phone plug, Right angle, Diecast Shell, Satin finish, Flexible grommet.</p>	Standard	ACPM-RN
			Gold contacts	ACPM-RN-AU
			Bulk Pack	ACPM-RN BULK
		<p>1/4" (6.35mmø) Mono Phone plug, Right angle, Diecast Shell, Black finish, Flexible grommet.</p>	Standard	ACPM-RB
			Gold contacts	ACPM-RB-AU
			Bulk Pack	ACPM-RB BULK
		<p>1/4" (6.35mmø) Stereo Phone plug, Right angle, Diecast Shell, Satin finish, Flexible grommet.</p>	Standard	ACPS-RN
			Gold contacts	ACPS-RN-AU
			Bulk Pack	ACPS-RN BULK
		<p>1/4" (6.35mmø) Stereo Phone plug, Right angle, Diecast Shell, Black finish, Flexible grommet.</p>	Standard	ACPS-RB
			Gold contacts	ACPS-RB-AU
			Bulk Pack	ACPS-RB BULK



PART NUMBER BREAKDOWN

M / M SERIES II (MUSICIAN RANGE)

E. G. **ACPM-GB-AU BULK**
ACP (Series Prefix), **M**ale, **G**(Shell Type), **B**lack,
 - **AU** (Gold Plated Contacts), **BULK** Packaged.

SERIES PREFIX	ACP =	Series Prefix
CONTACT TYPE	M =	2 pole (Mono)
	S =	3 pole Tip/Ring/Sleeve (Stereo)
SHELL TYPE	G =	M Series Straight
	K =	M Series II Straight
	R =	M Series Right Angle
	T =	M Series II Right Angle
SHELL FINISH	N =	Satin Nickel
	B =	Matt Black
CONTACT PLATING	Blank =	Nickel Plating
	AU =	Gold Plated
PACKAGING	Blank =	Individual Bags
	BULK =	Bulk Packed

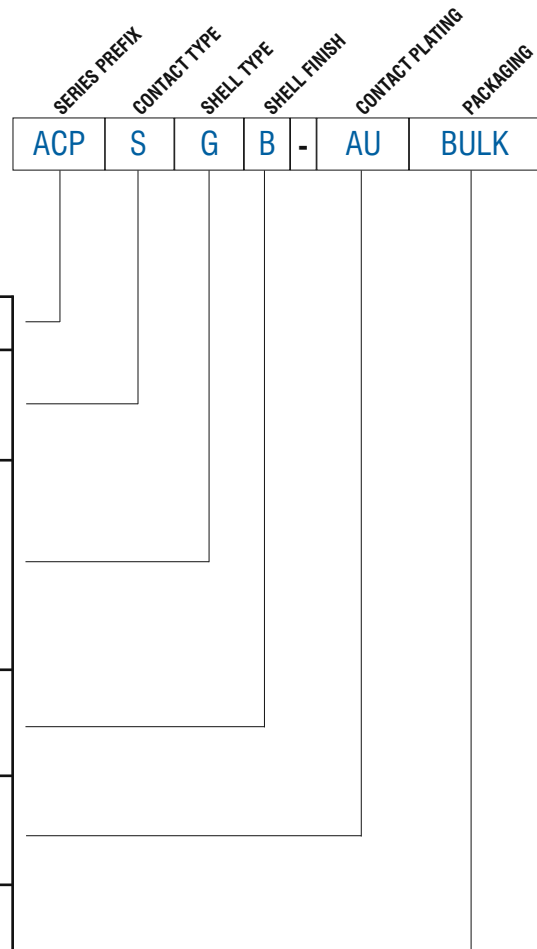



1/4" PHONE JACK CONNECTORS

Amphenol phone connectors are available in 1/4" (6.35mm) and 3.5mm jack sockets or dual jack socket versions featuring combinations of both sizes. The standard heavy duty contacts provide excellent signal performance and the rugged designs excel in professional audio applications. Our wide range of options ensures we have the connector to suit your specific requirements. Custom jacks can also be developed to suit unique applications on request.

Applications

- Audio Cables and Snakes
- Amplifiers
- Speakers
- Mixing desks
- Rack mount equipment
- Patch panel

Features / Options – OEM RANGE Phone Jack

- Mono or Stereo (TRS)
- Stackable (Piggy back) mounting
- Vertical or horizontal PCB mount
- Mono and Stereo switched contacts
- Solder contacts
- Combo Contacts
- Metal nut
- Plastic Nut
- 1/4" (6.35mm)
- 3.5mm
- Dual 1/4" (6.35mm) and 3.5mm
- EMI Shielding plates
- Metal Mounting threads
- Plastic Mounting threads
- Chassis Ground connections
- Half, Full or No threads
- Grounded or Isolated Jacks

1/4" Phone Jack Grounding/ Shielding Options

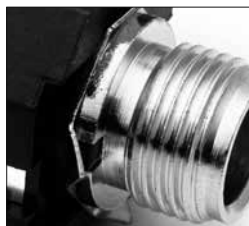

1/4" Gripper - Grounding points



1/4" Shielding Plate

Ordering Codes

We have listed the more common ordering codes in each section. Please contact us if you need any further assistance.

Simple steps to guide you in using this catalogue

- 1) Identify the product group listed in Contents on page 1 and go directly to that page number.
- 2) Each product group cover page then details information and options available.
- 3) Refer to the product detail pages and identify the product you require pictorially.
- 4) Read the product description column for the products standard features.
- 5) Use variations column to determine your choice.
- 6) Identify part number.
- 7) In the event the particular option you require is not listed please refer to the part number breakdown page at the end of each section.
- 8) Please contact us directly if you have any further problems.



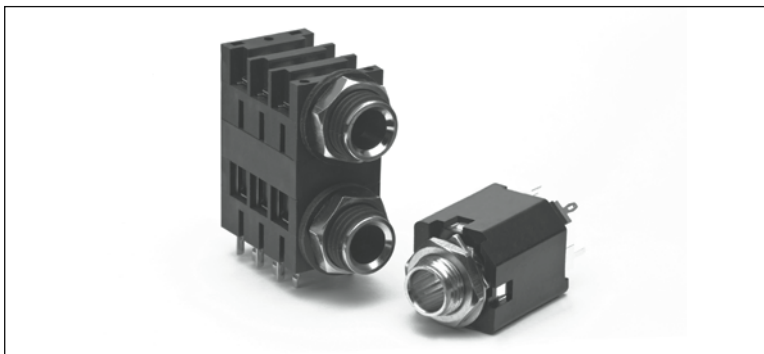

Features:

- 3.5mm and 6.35mm (1/4") options
- Mono or Stereo (TRS)
- Single or Dual mounting
- Vertical or Horizontal PCB mount
- Mono and Stereo with switching contacts
- Solder or Combo contacts
- Various mounting option

Schematic Chart: Page 107

Panel Cutouts: Page 106

PCB Footprints: Page 108

Specifications: Page 109











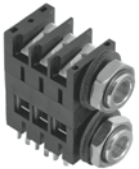
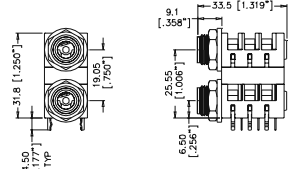
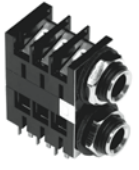
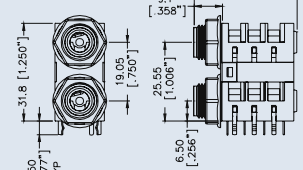

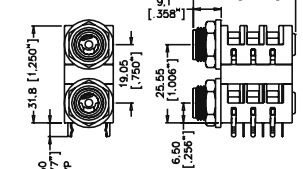
PRODUCT - FIGURE	DRAWING	DESCRIPTION	VARIATIONS	PART NUMBER
3.5MM PHONE JACKS				
		3.5mm Jack, Horizontal PCB, Plastic housing, Metal entry bore	Mono	ACJM-NH35
			Stereo	ACJS-NH35
		3.5mm Jack, Vertical PCB mount, Needle eye contacts, Plastic housing, Metal entry bore	Refer to Schematic Chart on page 107	ACJM-NV35-2 ACJM-NV35-2S ACJS-NV35-3 ACJS-NV35-3S ACJS-NV35-5
		3.5mm Jack, Vertical PCB mount, Needle eye contacts, Plastic housing, Metal thread and entry bore	Refer to Schematic Chart on page 107	ACJM-MV35-2 ACJM-MV35-2S ACJS-MV35-3 ACJS-MV35-3S ACJS-MV35-5
		3.5mm / 1/4" (6.35mm) Dual Phone Jack, Piggy-back, Horizontal PCB, Plastic housing, Metal nut and entry bore	Mono	ACJM-MHD985
			Stereo	ACJS-MHD985
		3.5mm / 1/4" (6.35mm) Dual Phone Jack, Vertical PCB mount, Needle eye contacts, Plastic housing, Metal nut and entry bore	Refer to Schematic Chart on page 107	ACJM-MVD985-2 ACJM-MVD985-2S ACJS-MVD985-3 ACJS-MVD985-3S ACJS-MVD985-5
1/4" PHONE JACKS HORIZONTAL				
		1/4" (6.35mm) Phone Jack, Horizontal Snap-fit PCB, Plastic housing, Half thread, Metal entry bore. Supplied without mounting hardware.	Mono	ACJM-HHDR
			Stereo	ACJS-HHDR

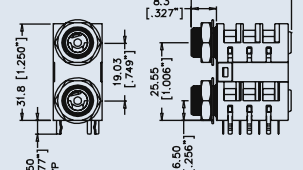
PRODUCT - FIGURE	DRAWING	Dimensions in mm (inches)	DESCRIPTION	VARIATIONS	PART NUMBER
			1/4" (6.35mmø) Phone Jack, Horizontal Snap-fit PCB, Plastic housing, Metal nut and entry bore	Mono	ACJM-MHDR
				Stereo	ACJS-MHDR
			1/4" (6.35mmø) Phone Jack, Horizontal Snap-fit PCB, Plastic housing, Metal thread, nut, washer and entry bore	Mono	ACJM-MHDRM
				Stereo	ACJS-MHDRM
			1/4" (6.35mmø) Offset Jack, Horizontal PCB mount, Plastic housing and entry bore with Half thread. Supplied without mounting hardware.	Refer to Schematic Chart on page 107	ACJM-HHOP
					ACJS-HHOP
			1/4" (6.35mmø) Offset Jack, Horizontal PCB mount, Plastic housing and entry bore with Half thread. Supplied without mounting hardware.	Refer to Schematic Chart on page 107	ACJM-HHOP-1
					ACJS-HHOP-1
			1/4" (6.35mmø) Offset Jack, Horizontal PCB mount, Plastic housing, thread and entry bore	Mono - Plastic Nut	ACJM-PHOP
				Mono - Metal Nut	ACJM-MHOP
				Stereo - Plastic Nut	ACJS-PHOP
				Stereo - Metal Nut	ACJS-MHOP
			1/4" (6.35mmø) Offset Jack, Horizontal PCB mount, Plastic housing, thread and entry bore. Non-switching sleeve contact with separate grounding to panel.	Refer to Schematic Chart on Page 110	ACJM-PHOP-1
				PHOP - Denotes Plastic Nut	ACJM-MHOP-1
				MHOP - Denotes Metal Nut	ACJS-PHOP-1
					ACJS-MHOP-1
			1/4" (6.35mmø) Offset Jack, Horizontal PCB mount, Plastic housing, Metal thread and entry bore with Chassis ground connection	Mono - Metal Nut	ACJM-MHOM
				Stereo - Metal Nut	ACJS-MHOM
			1/4" (6.35mmø) Jack, Horizontal PCB mount, Plastic housing with metal insert	Mono - Plastic Nut	ACJM - PH
				Mono - Metal Nut	ACJM - MH

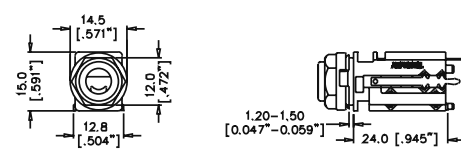

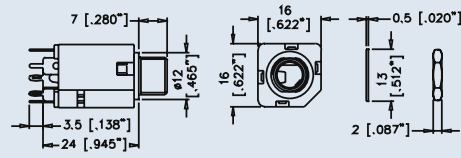
PRODUCT - FIGURE	DRAWING Dimensions in mm (inches)	DESCRIPTION	VARIATIONS	PART NUMBER
		1/4" (6.35mmø) Jack, Horizontal PCB mount, Plastic housing with metal insert	Stereo - Plastic Nut	ACJS - PH
			Stereo - Metal Nut	ACJS - MH
		1/4" (6.35mmø) Jack, Horizontal Snap-fit PCB mount, Plastic housing with metal insert	Mono - Plastic Nut	ACJM-PHR
			Mono - Metal Nut	ACJM-MHR
			Stereo - Plastic Nut	ACJS-PHR
			Stereo - Metal Nut	ACJS-MHR
		1/4" (6.35mmø) Jack, Combination Horizontal PCB mount and Solder lug, Plastic housing with metal insert	Mono - Plastic Nut	ACJM-PC
			Mono - Metal Nut	ACJM-MC
			Stereo - Plastic Nut	ACJS-PC
			Stereo - Metal Nut	ACJS-MC
		1/4" (6.35mmø) Jack, Solder Lug, Plastic housing with metal insert	Mono - Plastic Nut	ACJM-PHS
			Mono - Metal Nut	ACJM-MHS
			Stereo - Plastic Nut	ACJS-PHS
			Stereo - Metal Nut	ACJS-MHS
		1/4" (6.35mmø) Jack, Solder Lug, Plastic housing and Bezel with threaded Metal nut.	Mono	ACJM-IHS
			Stereo	ACJS-IHS
		1/4" (6.35mmø) Jack, Horizontal PCB mount, Plastic housing and Bezel with threaded Metal nut.	Mono	ACJM-IH
			Stereo	ACJS-IH
1/4" PHONE JACKS HORIZONTAL DUAL		1/4" (6.35mmø) Dual Phone Jack (Compact Piggyback), Horizontal Snap-fit PCB, Plastic housing, Metal nut and entry bore	Mono	ACJM-MHDC*
			Stereo	ACJS-MHDC*
Stereo	ACJS-MHDCM			

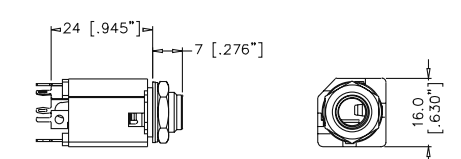

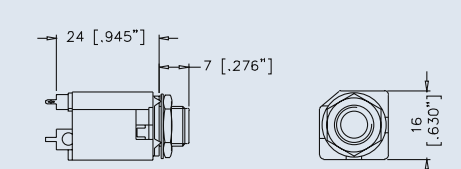
PRODUCT - FIGURE	DRAWING	Dimensions in mm (inches)	DESCRIPTION	VARIATIONS	PART NUMBER
			1/4" (6.35mmØ) Dual Phone Jack (Piggyback) Horizontal Snap-fit PCB, Plastic housing, Metal nut and entry bore	Mono Stereo	ACJM-MHD* ACJS-MHD*
			1/4" (6.35mmØ) Dual Phone Jack (Piggyback) Shielding plate, Horizontal Snap-fit PCB, Plastic housing, Metal nut and entry bore	Mono Stereo	ACJM-MHDE* ACJS-MHDE*
			1/4" (6.35mmØ) Dual Phone Jack (Piggyback), Horizontal Snap-fit PCB, Plastic housing, Metal thread, washer and entry bore	Mono Stereo	ACJM-MHDM* ACJS-MHDM*
			1/4" (6.35mmØ) Dual Phone Jack (Piggyback), Shielding plate Horizontal Snap-fit PCB, Plastic housing, Metal thread, nut and entry bore	Mono Stereo	ACJM-MHDEM* ACJS-MHDEM*
1/4" PHONE JACKS VERTICAL					
			1/4" (6.35mmØ) Jack, Vertical PCB mount, Plastic housing, nut and entry bore	Refer to Schematic Chart on page 107	ACJM-PVB-2 ACJM-PVB-2S ACJS-PVB-3 ACJS-PVB-3S ACJS-PVB-5
			1/4" (6.35mmØ) Jack, Vertical PCB mount, Needle eye contacts, Plastic thread, Metal nut and insert	Refer to Schematic Chart on page 107	ACJM-MIV-2 ACJM-MIV-2S ACJS-MIV-3 ACJS-MIV-3S ACJS-MIV-5
			1/4" (6.35mmØ) Jack, Vertical PCB mount, Needle eye contacts, Star washer, Metal nut and insert	Refer to Schematic Chart on page 107	ACJM-MN-2 ACJS-MN-3 ACJM-MN-2S ACJS-MN-3S ACJS-MN-5
			1/4" (6.35mmØ) Jack, Vertical PCB mount, Metal nut and insert	Refer to Schematic Chart on page 107	ACJM-MV-2 ACJM-MV-2S ACJS-MV-3 ACJS-MV-3S ACJS-MV-5

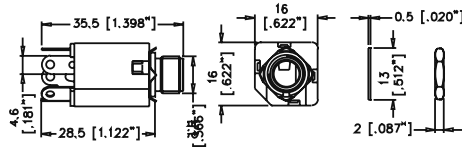

PRODUCT - FIGURE	DRAWING	DESCRIPTION	VARIATIONS	PART NUMBER
	 <p>Dimensions in mm (inches)</p>	1/4" (6.35mm) Jack, Solder Lug, Metal nut and insert	Refer to Schematic Chart on Page 110	<p>ACJM-MVS-2</p> <p>ACJM-MVS-2S</p> <p>ACJS-MVS-3</p> <p>ACJS-MVS-3S</p> <p>ACJS-MVS-5</p>

PANEL CUTOUTS

-FRONT VIEW

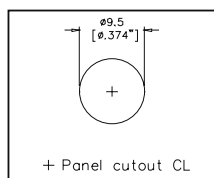

ACJM-MV
ACJS-MV
ACJM-MN-2
ACJS-MN-3
ACJM-MN-2S
ACJS-MN-3S
ACJM-MN-5
ACJS-MN-5
ACJM-MIV
ACJS-MIV
ACJM-MVS
ACJS-MVS

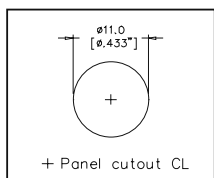

ACJM/S-PH
ACJM/S-MH
ACJM/S-PC
ACJM/S-MC
ACJM/S-PHR
ACJM/S-MHR
ACJM/S-PHS
ACJM/S-MHS

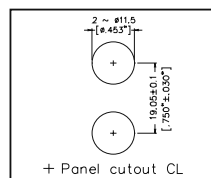

ACJM-MHD
ACJS-MHD
ACJM-MHDE
ACJS-MHDE

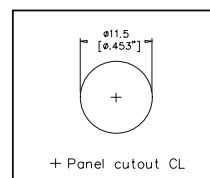

ACJM-MHDR
ACJS-MHDR
ACJS-HHDR

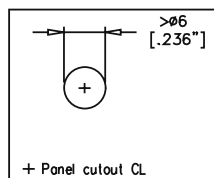

ACJM-NH35
ACJS-NH35

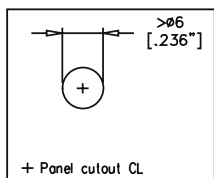

ACJM-NV35-2
ACJM-NV35-2S
ACJS-NV-35-3
ACJS-NV-35-3S
ACJS-NV-35-5
ACJM-MV35-2
ACJM-MV35-2S
ACJS-MV-35-3
ACJS-MV-35-3S
ACJS-MV-35-5

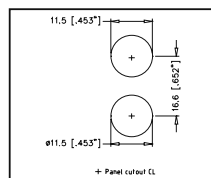

ACJS-MHDC
ACJM-MHDC

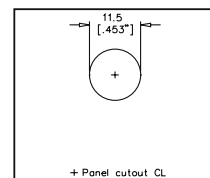

ACJS-IH
ACJM-IH
ACJS-IHS
ACJM-IHS

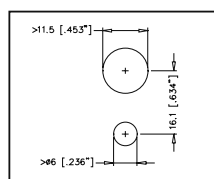

ACJM-MHD985
ACJS-MHD985

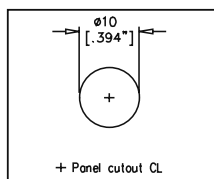

ACJS-MHOM
ACJM-MHOM

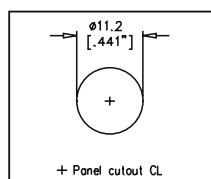

ACJS-MHOP
ACJS-PHOP
ACJM-MHOP
ACJM-PHOP
ACJS-MHOP-1
ACJS-HHOP-1
ACJS-PHOP-1
ACJM-PHOP-1
ACJM-MHOP-1
ACJM-HHOP-1
ACJM-HHOP
ACJS-HHOP

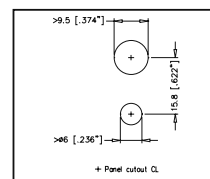

ACJS-MVD985
ACJM-MVD985

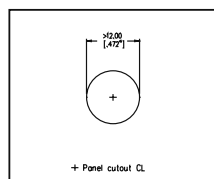

ACJM-PVB-2
ACJM-PVB-2S
ACJS-PVB-3
ACJS-PVB-3S
ACJS-PVB-5

SCHEMATIC CHART

PART NO.	ACJM-MV35-2 ACJM-MN-2 ACJM-NV35-2 ACJM-PVB-2 ACJM-MV-2 ACJM-MVS-2 ACJM-MIV-2	ACJM-MV35-2S ACJM-MN-2S ACJM-NV35-2S ACJM-PVB-2S ACJM-MV-2S ACJM-MVS-2S ACJM-MIV-2S	ACJS-MV35-3 ACJS-MN-3 ACJS-NV35-3 ACJS-PVB-3 ACJS-MV-3 ACJS-MVS-3 ACJS-MIV-3	ACJS-MV35-3S ACJS-MN-3S ACJS-NV35-3S ACJS-PVB-3S ACJS-MV-3S ACJS-MVS-3S ACJS-MIV-3S	ACJS-MV35-5 ACJS-MN-5 ACJS-NV35-5 ACJS-PVB-5 ACJS-MV-5 ACJS-MVS-5 ACJS-MIV-5
GENERAL SCHEMATIC					

PART NO.	ACJM-MVD985-2	ACJM-MVD985-2S	ACJS-MVD985-3	ACJS-MVD985-3S	ACJS-MVD985-5
SCHEMATIC					

PART NO.	ACJM-HHOP-1 ACJM-PHOP-1 ACJM-MHOP-1	ACJS-HHOP-1 ACJS-PHOP-1 ACJS-MHOP-1	ACJM-HHOP ACJM-PHOP ACJM-MHOP	ACJS-HHOP ACJS-PHOP ACJS-MHOP
GENERAL SCHEMATIC				



PCB FOOTPRINT - CONNECTOR SIDE OF PCB

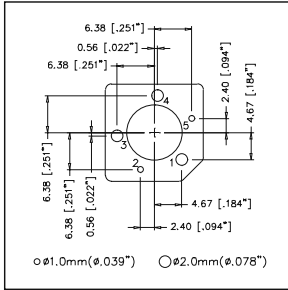

ACJM-MV
ACJS-MV
ACJM-MN-2
ACJS-MN-3
ACJM-MN-2S
ACJS-MN-3S
ACJM-MN-5
ACJS-MN-5
ACJM-NV35-XX
ACJS-NV35-XX
ACJM-MIV-2
ACJS-MIV-2S
ACJM-MIV-3
ACJS-MIV-3S
ACJM-MIV-3
ACJS-MIV-5

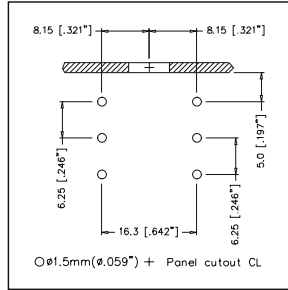

ACJM-PH
ACJM-MH
ACJS-PH
ACJS-MH
ACJM-PC
ACJM-MC
ACJS-PC
ACJS-MC

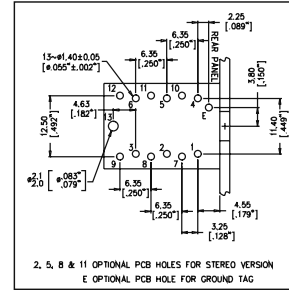

ACJM-MHD
ACJS-MHD
ACJM-MHDE
ACJS-MHDE
ACJM-MHDEM
ACJS-MHDEM
ACJM-MHDC
ACJS-MHDC
ACJM-MHDCM
ACJS-MHDCM
ACJM-MHDM
ACJS-MHDM

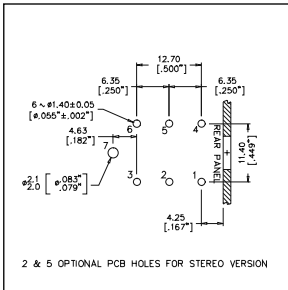

ACJM-MHDR
ACJS-MHDR
ACJM-PHR
ACJM-MHR
ACJS-PHR
ACJS-MHR
ACJM-HHDR
ACJS-HHDR
ACJM-MHDM
ACJS-MHDM

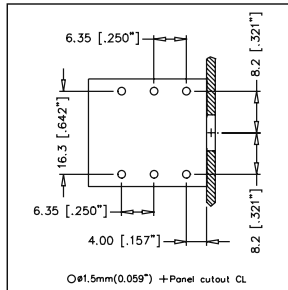

ACJS-IH
ACJM-IH

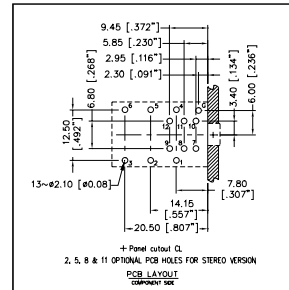

ACJS-MHD985
ACJM-MHD985

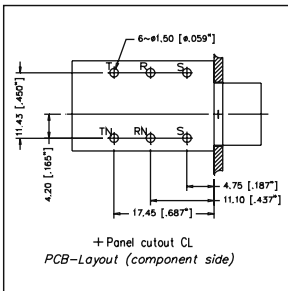

ACJS-MHOM
ACJM-MHOM

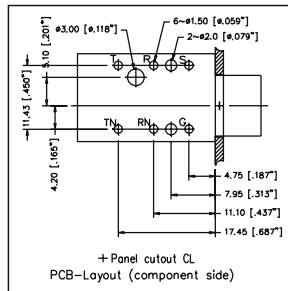

ACJS-MHOP-1
ACJS-PHOP-1
ACJS-HHOP-1
ACJM-MHOP-1
ACJM-PHOP-1
ACJM-HHOP-1

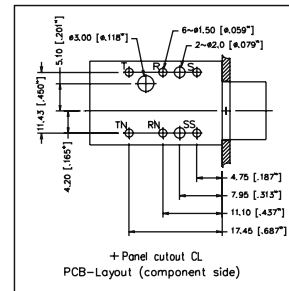

ACJS-MHOP
ACJS-PHOP
ACJM-MHOP
ACJM-PHOP
ACJM-HHOP
ACJS-HHOP

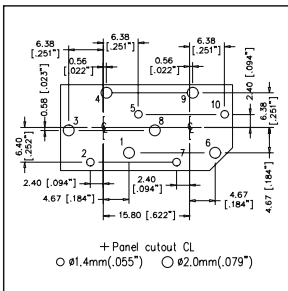

ACJS-MVD985
ACJM-MVD985

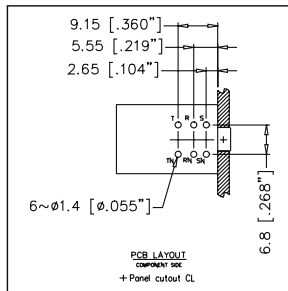

ACJS-NH35
ACJM-NH35

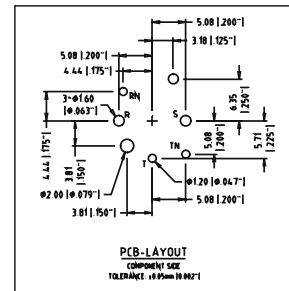

ACJM-PVB-2
ACJS-PVB-2S
ACJS-PVB-3
ACJS-PVB-3S
ACJM-PVB-5

1/4" PLUGS TECHNICAL DATA

		VALUE
GENERAL CHARACTERISTICS	Number of Contacts	2 Pole (Mono) 3 Pole Tip Ring Sleeve (Stereo)
	Termination	Solder
	Max. Wire Gauge - Stranded Wire	2 Pole (Mono): AWG 16 ~ 1.5mm ² 3 Pole (Stereo): AWG 18 ~ 1mm ²
	Flammability rating of insulating plastics	UL94V-0
	Solderability, complies with	IEC 68-2-20
	Environmental	Complies with EU RoHS 2 Directive 2011/65/EU
ELECTRICAL CHARACTERISTICS	Current Carrying Capacity	10A (Depends on Mating Connector and Cable)
	Typical Contact Resistance	Depends on Mating Connector
	Insulation resistance (initial) After Damp Heat Test	> 2GΩ ≥ 1GΩ
	Dielectric Withstand Voltage	2 Pole : 1.5 kV dc 3 Pole : 1 kV dc
CLIMATIC CHARACTERISTICS	Protection Class	IP40
	Operating Temperature	-25°C to +70°C (-13°F to 158°F)
MECHANICAL CHARACTERISTICS	Insertion and Withdrawal Force	≥ 10N - ≤ 30N
	Mating Cycles	Min. of 1000 cycles without any physical damage
	Cable O.D. - M Series - M Series II	3mm to 6.5mm (0.118" to 0.256") 6.5mm to 8mm (0.256" to 0.315")
MATERIALS	Connector Shell Material	Diecast Zinc Alloy EZDA No.3
	Connector Shell Finish	Satin Nickel or Black Polyester
	Insulators	UL94 V-0 PBT Resin or Modified PPE Resin and fibreglass laminate
	Cable Bushing	Santoprene
	Contact Plating	Brass / Ni over Cu (Copper)

Rev 4 - 05/2014

¹⁾Approximate weight only, does not include packaging. Please contact us for exact weight for shipping purposes.



1/4" JACKS TECHNICAL DATA

		VALUE
GENERAL CHARACTERISTICS	Number of Contacts	2 Pole (Mono) 3 Pole Tip Ring Sleeve (Stereo)
	Termination	Solder, PCB or Combo
	Flammability rating of insulating plastics	UL94V-0
	Solderability, complies with	IEC 68-2-20
	Environmental	Complies with EU RoHS 2 Directive 2011/65/EU
ELECTRICAL CHARACTERISTICS	Current Carrying Capacity	10A (Depends on Mating Connector and Cable)
	Typical Contact Resistance	≤10mΩ
	Insulation resistance (initial) After Damp Heat Test	>2GΩ ≥10 ³ Meg Ω
	Rated Voltage Test Voltage AC RMS: Dielectric Strength	34V 500V
CLIMATIC CHARACTERISTICS	Protection Class	IP40
	Operating Temperature	-25°C to +70°C (-13°F to 158°F)
MECHANICAL CHARACTERISTICS	Insertion and Withdrawal Force	≥10N - ≤30N
	Mating Cycles	Min. of 1000 cycles without any physical damage
	Weight - Straight - Right Angle	18g (0.039lb) 25g (0.055lb)
MATERIALS	Connector Shell Material	Nylon PA66 30% Glass Filled
	Insulators	UL94 V-0 PBT Resin or Modified PPE Resin and fiberglass laminate
	Metal Nut	Brass
	Plastic Nut	Nylon PA66 30% Glass Filled
	Washer	Fiber / Brass / Nylon PA66 30% Glass Filled
	Contact Plating	Tin - 4μm Min. over 2μm Min.Cu (Copper) Silver - 0.3μm Min. over 2μm Min.Cu (Copper) Nickel - 2μm Min. over 2μm Min.Cu (Copper) Gold Flash - 0.05μm Min. over 2μm Min.Cu (Copper)
	Contacts	Brass / Sn (Tin) over Cu (Copper)

Rev 4 - 05/2014

¹Approximate weight only, does not include packaging. Please contact us for exact weight for shipping purposes.





PLUGS AND SOCKETS

Amphenol's plugs and sockets range continually expands to meet the needs of our customers. The success of the M-Series phone plugs led to the RCA series being developed. The Miniature XLR range was a natural progression from our standard XLR series as demand for smaller interconnects increased. The latest addition to the range is a professional grade 3.5mm phone plug designed for applications that require a robust interconnect.

Applications

- Audio Cables and Snakes
- Amplifiers
- Speakers
- Mixing desks
- Rack mount equipment
- Patch panel

Features / Options – RCA Plugs and Jacks

- Red, Black, White, Yellow, Blue or Green shell colours
- Stylish shell design
- Flexible grommet cable protection
- Gold Plated Contacts

Features / Options – Miniature XLR

- 3,4,5, or 6 contacts
- Solder cup
- Printed Circuit Board
- Vertical or Horizontal mounting
- Positive locking latch
- Flexible cable clamp
- Metal cable clamp
- Locking rings
- Chassis front mount
- Chassis middle or rear mount (on request)
- Optional black finish (on request)

Features / Options – 3.5mm Plugs Phone Jack

- Mono / Stereo TRS
- Solder contacts
- Suits cable O.D 2.5mm to 5mm
- Stylised shell design
- Flexible cable grommet
- Metal cable clamp
- Nickel or Gold contact plating
- Satin Nickel or Black finish

Cable Clamp Options



RCA Cable Clamp - M-Series, Cable O.D 3mm to 6.5mm (0.118" to 0.256")

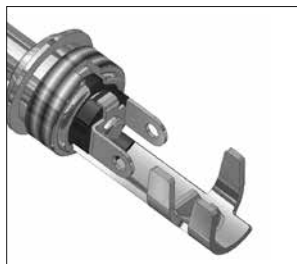

K-Series, Cable O.D 3mm to 5mm (0.118" to 0.196")

Ordering Codes

We have listed the more common ordering codes in each section. Please contact us if you need any further assistance.

Simple steps to guide you in using this catalogue

- 1) Identify the product group listed in Contents on page 1 and go directly to that page number.
- 2) Each product group cover page then details information and options available.
- 3) Refer to the product detail pages and identify the product you require pictorially.
- 4) Read the product description column for the products standard features.
- 5) Use variations column to determine your choice.
- 6) Identify part number.
- 7) In the event the particular option you require is not listed please refer to the part number breakdown page at the end of each section.
- 8) Please contact us directly if you have any further problems.



3.5mm K-SERIES



Features:

- Mono or TRS (Stereo).
- AX Series inspired shell design.
- Suits Cable O.D from 2.5mm to 5mm (0.098" to 0.196")
- Robust diecast shell in Satin nickel or Black finish.
- Nickel or Gold contact plating.
- Flexible grommet cable protection.
- Improved solderability.
- Precision machined contacts.
- Standard or Bulk packaging.

Options: Black Shell, Gold contacts.

PRODUCT - FIGURE	DRAWING	Dimensions in mm (inches)	DESCRIPTION	VARIATIONS	PART NUMBER
		49 [1.911"] 35 [1.370"] ø10.3 [ø.406"]	3.5mm, Mono Phone plug, Diecast Shell, Satin finish, Flexible grommet.	Standard Gold Plated Contacts Bulk Pack	KM2P KM2P-AU KM2P BULK
		49 [1.911"] 35 [1.370"] ø10.3 [ø.406"]	3.5mm, Mono Phone plug, Diecast Shell, Black finish, Flexible grommet.	Standard Gold Plated Contacts Bulk Pack	KM2PB KM2PB-AU KM2PB BULK
		49 [1.911"] 35 [1.370"] ø10.3 [ø.406"]	3.5mm, Stereo Phone plug, Diecast Shell, Satin finish, Flexible grommet.	Standard Gold Plated Contacts Bulk Pack	KS3P KS3P-AU KS3P BULK
		49 [1.911"] 35 [1.370"] ø10.3 [ø.406"]	3.5mm, Stereo Phone plug, Diecast Shell, Black finish, Flexible grommet.	Standard Gold Plated Contacts Bulk Pack	KS3PB KS3PB-AU KS3PB BULK
		51 [2.008"] 37 [1.467"] 3.10 [.122"] ø10.3 [ø.406"]	3.5mm, Stereo Phone plug with extended shaft for mobile phones fitted with covers. Diecast Shell, Black Chrome finish, Flexible grommet	Standard Gold Plated Contacts	KS3PC KS3PC-AU



PART NUMBER BREAKDOWN

K-SERIES

E. G. **KS3P-AU BULK**
K (Series Prefix), **S3**(Stereo), Plug,
AU (Gold Plated Contacts), **Bulk** Packaged.

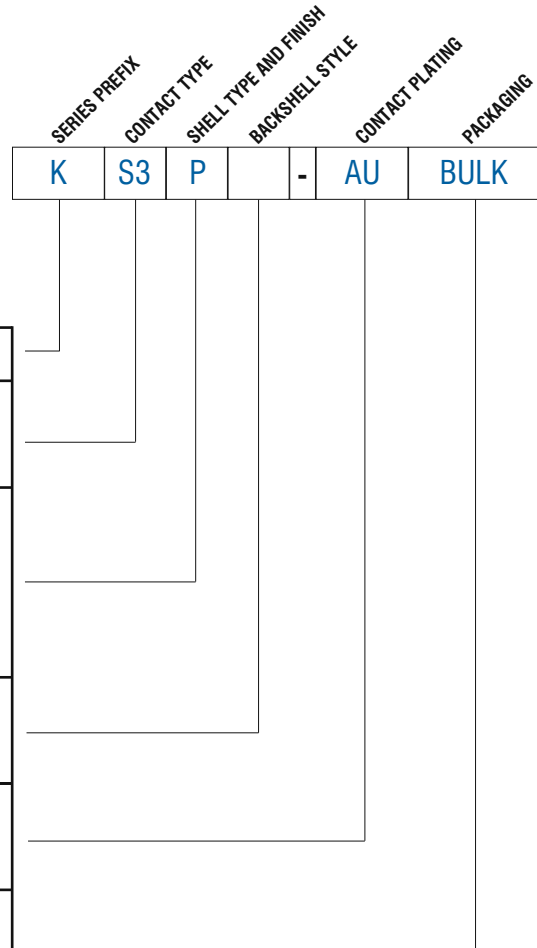

SERIES PREFIX	K	=	Series Prefix
CONTACT TYPE	M2	=	2 Pole (mono)
	S3	=	3 pole TRS (Stereo)
SHELL TYPE AND FINISH	P	=	Plug Satin Nickel
	PB	=	Plug Matt Black
	PC	=	Plug Black Chrome
BACKSHELL TYPE AND CABLE CLAMP	Blank	=	K Series to suit Cable O.D 2.5mm to 5mm (0.098" to 0.196")
CONTACT PLATING	Blank	=	Nickel Plated Contacts (Standard)
	AU	=	Gold Plated Contacts
PACKAGING	Blank	=	Individual Bags
	BULK	=	Bulk Packed

ISO VIEW OF KS3P

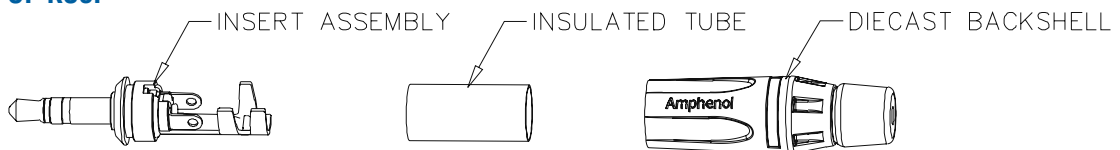

3.5mm PLUG TECHNICAL DATA

		VALUE
GENERAL CHARACTERISTICS	Number of Contacts	2 Pole (Mono) 3 Pole Tip Ring Sleeve (Stereo)
	Termination	Solder
	Wire Gauge - Stranded Wire	2 Pole (Mono): AWG 16 - 1.5mm ² 3 Pole (Stereo): AWG 18 - 1mm ²
	Flammability rating of insulating plastics	UL94V-0
	Solderability, complies with	IEC 68-2-20
	Environmental	Complies with EU RoHS 2 Directive 2011/65/EU
ELECTRICAL CHARACTERISTICS	Current Carrying Capacity	>0.5mA (Depends on Mating Connector and Cable)
	Typical Contact Resistance	≤20mΩ (Depends on Mating Connector and Cable)
	Insulation resistance (initial) After Damp Heat Test	>200M Ω >100M Ω
	Test Voltage AC RMS: Dielectric Strength	250VAC
CLIMATIC CHARACTERISTICS	Protection Class	IP40
	Operating Temperature	-20°C to +65°C (-4°F to +149°F)
MECHANICAL CHARACTERISTICS	Insertion and Withdrawal Force	<20N / >3N (depends on mating connector)
	Cable O.D.	3mm to 5mm (0.118" to 0.196")
	Mechanical Operations	1000 mating cycles
	Weight	8g (0.017lb)
MATERIALS	Connector Shell Material (Plugs)	Diecast Zinc Alloy EZDA No.3
	Connector Shell Finish	Satin Nickel or Black Polyester
	Insulators	PA66
	Cable Bushing	Santoprene
	Contacts	Brass
	Plating	Nickel or Gold Flash

¹ Approximate weight only, does not include packaging. Please contact us for exact weight for shipping purposes.











RCA SERIES

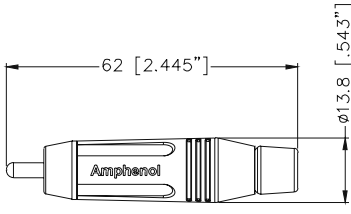

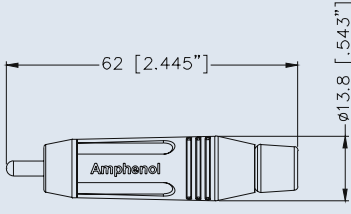
Features:

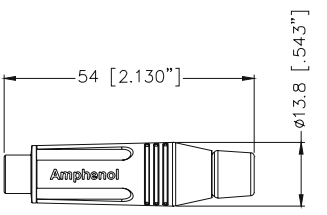
- Stylish design
- Flexible grommet cable protection
- Robust diecast shell
- Gold plated contacts
- Colour coded
- Good solderability
- Quick and easy assembly
- Panel mount utilises standard 'D' type housing

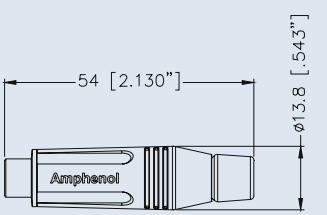
Part Number Breakdown: Page 116

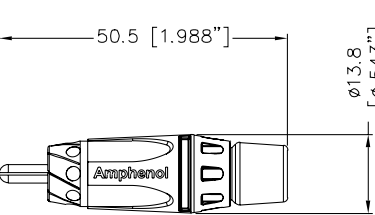
PRODUCT - FIGURE	DRAWING	Dimensions in mm (inches)	DESCRIPTION	VARIATIONS	PART NUMBER
		62 [2.445"] ø13.8 [.543"]	RCA Plug, Diecast Shell, Gold plated contacts, Coloured finish, Flexible coloured grommet	Red Black Yellow White Blue Green	ACPR-RED ACPR-BLK ACPR-YEL ACPR-WHT ACPR-BLU ACPR-GRN
		62 [2.445"] ø13.8 [.543"]	RCA Plug, Diecast Shell, Gold plated contacts, Satin finish, Flexible coloured grommet	Satin / Red Satin / Black Satin / Yellow Satin / White Satin / Blue Satin / Green	ACPR-SRD ACPR-SBK ACPR-SYL ACPR-SWH ACPR-SBL ACPR-SGR
		54 [2.130"] ø13.8 [.543"]	RCA Jack, Diecast Shell, Gold plated contacts, Coloured finish, Flexible coloured grommet	Red Black Yellow White Blue Green	ACJR-RED ACJR-BLK ACJR-YEL ACJR-WHT ACJR-BLU ACJR-GRN
		54 [2.130"] ø13.8 [.543"]	RCA Jack, Diecast Shell, Gold plated contacts, Satin finish, Flexible coloured grommet	Satin / Red Satin / Black Satin / Yellow Satin / White Satin / Blue Satin / Green	ACJR-SRD ACJR-SBK ACJR-SYL ACJR-SWH ACJR-SBL ACJR-SGR
		50.5 [1.988"] ø13.8 [ø.543"]	RCA Plug, Shortened Diecast Shell, Gold plated contacts, Black Chrome finish, Flexible coloured grommet	Red Black Yellow White Blue Green	ACPL-CRD ACPL-CBK ACPL-CYL ACPL-CWH ACPL-CBL ACPL-CGR

NOTE: RCA Series comply with EU RoHS 2 Directive 2011/65/EU

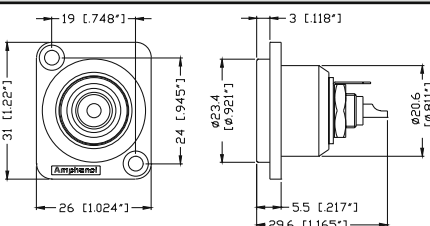
PRODUCT - FIGURE	DRAWING	Dimensions in mm (inches)	DESCRIPTION	VARIATIONS	PART NUMBER
			RCA Jack, Diecast Shell, Gold plated contacts, Nickel finish shell, coloured insulator.	<ul style="list-style-type: none"> Red Black Yellow White Blue Green 	<ul style="list-style-type: none"> ACJD-RED ACJD-BLK ACJD-YEL ACJD-WHT ACJD-BLU ACJD-GRN

NOTE: RCA Series comply with EU RoHS 2 Directive 2011/65/EU

PART NUMBER BREAKDOWN

M SERIES RCA

E. G. **ACPR-RED BULK**
AC (Series Prefix), **P** (Plug), **R** (Shell type), **RED** (Shell and Grommet Colour), **Bulk** Packaged.

SERIES PREFIX	CONTACT TYPE	SHELL TYPE	SHELL FINISH	PACKAGING	
AC	P	R	-	RED	BULK

SERIES PREFIX	AC	=	Series Prefix
CONTACT TYPE	J	=	RCA Female Jack
	P	=	RCA Male Plug
SHELL TYPE	R	=	Regular Shell Length
	L	=	Short Shell Length
	D	=	Chassis Jack 'D' Shell
SHELL AND GROMMET COLOUR	RED	=	Red, Red Grommet
	BLK	=	Black, Black Grommet
	YEL	=	Yellow, Yellow Grommet
	WHT	=	White, White Grommet
	BLU	=	Blue, Blue Grommet
	GRN	=	Green, Green Grommet
	SRD	=	Satin Nickel, Red Grommet
	CRD	=	Black Chrome, Red Grommet
	SBK	=	Satin Nickel, Black Grommet
	CBK	=	Black Chrome, Black Grommet
	SYL	=	Satin Nickel, Yellow Grommet
	CYL	=	Black Chrome, Yellow Grommet
	SWH	=	Satin Nickel, White Grommet
	CWH	=	Black Chrome, White Grommet
	SBL	=	Satin Nickel, Blue Grommet
	CBL	=	Black Chrome, Blue Grommet
	SGR	=	Satin Nickel, Green Grommet
	CGR	=	Black Chrome, Green Grommet
	NOTE: Denotes colour of insulator only on shell type D, Chassis Jack 'D' Shell. Shell finish is Nickel.		
PACKAGING	Blank	=	Individual Bags
	BULK	=	Bulk Packed

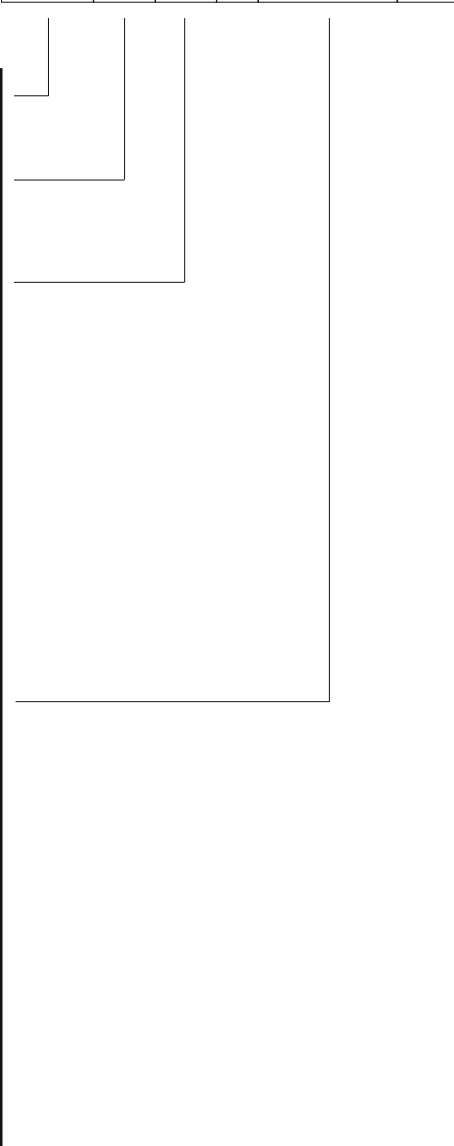

RCA TECHNICAL DATA

		VALUE
GENERAL CHARACTERISTICS	Number of Contacts	2
	Termination	Solder
	Max. Wire Gauge - Stranded Wire	AWG 14 - 2.5mm ²
	Flammability rating of insulating plastics	UL94V-0
	Solderability, complies with	IEC 68-2-20
	Environmental	Complies with EU RoHS 2 Directive 2011/65/EU
ELECTRICAL CHARACTERISTICS	Current Carrying Capacity	10A (Depends on Mating Connector)
	Typical Contact Resistance	≤10mΩ (Depends on Mating Connector)
	Insulation resistance (initial) After Damp Heat Test	> 2GΩ ≥ 10 ³ Meg Ω
	Dielectric Strength	1500 V dc
CLIMATIC CHARACTERISTICS	Protection Class	IP40
	Operating Temperature	-25°C to +75°C (-13°F to +167°F)
MECHANICAL CHARACTERISTICS	Insertion and Withdrawal Force	≥10N - ≤30N (depends on mating connector)
	Cable O.D.	3mm to 7mm (0.118" to 0.275")
	Mechanical Operations	500 mating cycles
	Weight - Cable Mount - Panel Mount	18g (0.039lb) 30g (0.066lb)
MATERIALS	Connector Shell Material (Plugs)	Diecast Zinc Alloy EZDA No.3
	Connector Shell Finish	Satin Nickel or Coloured Polyester
	Insulators	PA66
	Cable Bushing	Thermoplastic Polyurethane
	Contacts	Brass Alloy
	Plating	Gold Flash

Rev 4 - 05/2014

¹⁾Approximate weight only, does not include packaging. Please contact us for exact weight for shipping purposes.







Features:

- Miniature version of the standard XLR series
- Diecast or Precision machined metal housings
- Metal cable clamp
- Precision machined pin contacts
- Stamped socket contacts
- Solder cup or Printed Circuit board contacts
- Available in 3, 4, 5 or 6 contacts
- Postive latchlock
- Flexible cable grommet

Part Number Breakdown: Page 119 Specifications: Page 120
PCB Footprints: Page 121 Panel Cutouts: Page 121

PRODUCT - FIGURE	DRAWING	DESCRIPTION	VARIATIONS	PART NUMBER
		Male cable connector, Machined contacts, Nickel Finish	3 pole 4 pole 5 pole 6 pole	AG3M AG4M AG5M AG6M
		Female cable connector, Stamped contacts, Nickel Finish	3 pole 4 pole 5 pole 6 pole	AG3F AG4F AG5F AG6F
		Female cable connector with locking ring, Stamped contacts, Nickel Finish.	3 pole 4 pole 5 pole 6 pole	AG3FL AG4FL AG5FL AG6FL
		Male chassis connector, Machined contacts, Nickel Finish	3 pole 4 pole 5 pole 6 pole	AG3MCC AG4MCC AG5MCC AG6MCC
		Female chassis connector, Stamped contacts, Nickel Finish	3 pole 4 pole 5 pole 6 pole	AG3FCE AG4FCE AG5FCE AG6FCE
		Male chassis connector, Horizontal PCB, Machined contacts, Nickel Finish	3 pole 4 pole 5 pole 6 pole	AG3MCCH AG4MCCH AG5MCCH AG6MCCH
		Female chassis connector, Horizontal PCB, Stamped contacts, Nickel Finish	3 pole 4 pole 5 pole 6 pole	AG3FCCH AG4FCCH AG5FCCH AG6FCCH

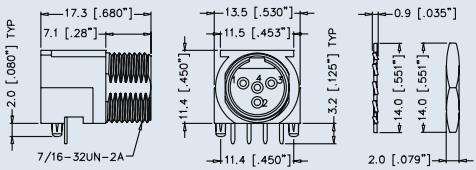
Amphenol

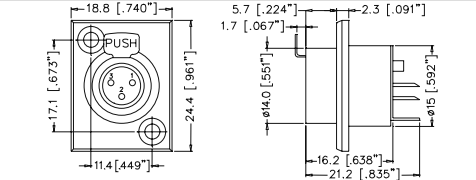
		<p>Male chassis connector, Horizontal PCB, Machined contacts, Thermoplastic shell</p>	<p>4 pole</p>	<p>AG4MPCH</p>
		<p>Female chassis connector, Stamped contacts, Nickel Finish</p>	<p>3 pole</p>	<p>AG3FCRV</p>
			<p>4 pole</p>	<p>AG4FCRV</p>
			<p>5 pole</p>	<p>AG5FCRV</p>
			<p>6 pole</p>	<p>AG6FCRV</p>

PART NUMBER BREAKDOWN

G TYPE CONNECTORS

E. G. **AG3MCCHB**
AG (Series Prefix), **3** contacts, **Male**, **Chassis Connector**, **Horizontal PCB Contacts**, **Black finish**.

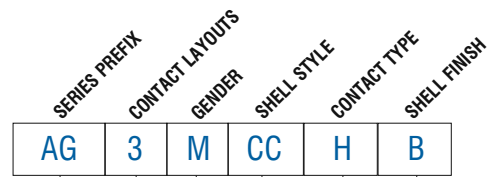

SERIES PREFIX	AG	=	Series Prefix
CONTACT LAYOUTS	3	=	3 Contacts
	4	=	4 Contacts
	5	=	5 Contacts
	6	=	6 Contacts
GENDER	F	=	Female Socket Contacts
	M	=	Male Pin Contacts
	Blank	=	Cable Connector Standard (Male or Female)
SHELL STYLE	J	=	Cable Connector Large Cable clamp / boot O.D (Male or Female)
	L	=	Cable Connector with locking ring (Female)
	LL	=	Latchless (Chassis Connector)
	CC	=	Chassis Connector Circular Metal (Male)
	CE	=	Rear Mount (Chassis Connector)
	CM	=	Mid Mount (Chassis Connector)
	CR	=	Chassis Connector Rectangular Metal (Female)
	PC	=	Chassis Connector Plastic (Male)
Blank	=	Solder Buckets (All styles except PC, CR)	
CONTACT TYPE	H	=	Horizontal PCB (Style CC, PC only)
	V	=	Vertical PCB (Style CR only)
	Blank	=	Nickel Plated Finish
SHELL FINISH	B	=	Black Finish



STANDARD DATA G TYPE

		VALUE			
GENERAL CHARACTERISTICS	Number of Contacts	3	4	5	6
	Termination	Printed Circuit Board (PCB) or Solder Bucket			
	Max. Wire Gauge - Stranded Wire	AWG 24 - 0.5mm ²			AWG 28 - 0.38mm ²
	Flammability	UL94V-0			
	Environmental	Complies with EU RoHS 2 Directive 2011/65/EU			
ELECTRICAL CHARACTERISTICS	Service Voltage RMS	1000V			250V
	Test Voltage AC RMS	125V AC			
	Current Carrying Capacity	5A	5A	4A	1.2A
	Typical Contact Resistance	≤10mΩ			
	Insulation resistance (initial) After Damp Heat Test	≥510MΩ ≥10MΩ			
	Dielectric Strength	1500 V dc			
CLIMATIC CHARACTERISTICS	Protection Class	IP00			
	Operating Temperature	-30°C to +80°C (-20F - +176F)			
MECHANICAL CHARACTERISTICS	Insertion Spring Separating Force	≥20N			
	Cable O.D.	2mm to 3.5mm (0.078" to 0.137")		3mm to 5mm (0.118" to 0.196")	
	Mechanical Operations	5000 mating cycles			2000 mating cycles
	Weight	13.5g (0.029lb)			
MATERIALS	Connector Shell	Bronze & Zinc			
	Connector Shell Finish	Nickel Plated			
	Insulators	PPS - Black			
	Male Contact	Material - Brass C3604 Plating - Gold over Silver Plated			
	Female Contact	Material - Brass C5210P Plating - Gold over Silver Plated			
	Latch Lock and Spring	SUS (AISI - 301) - Nickel Plated			
	Adaptor	PPS - Black			
	Cable Clamp	Bronze - Nickel Plated			
	Boot/Backshell	ABS - Black			
Grommet	PU - Black				

Rev 4 - 05/2014

¹⁾ Approximate weight only, does not include packaging. Please contact us for exact weight for shipping purposes.



PANEL CUTOUTS - CONNECTOR SIDE OF PCB

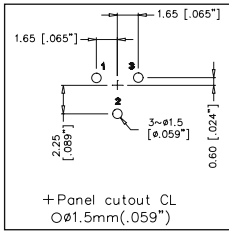

AG3MCC

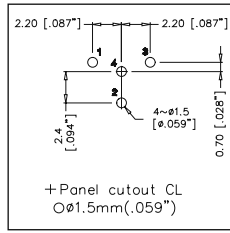

AG4MCC

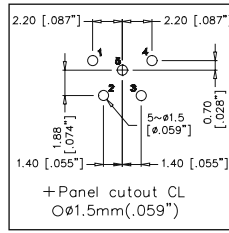

AG5MCC

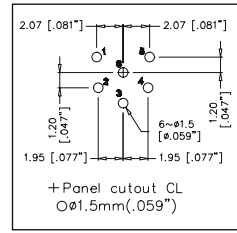

AG6MCC

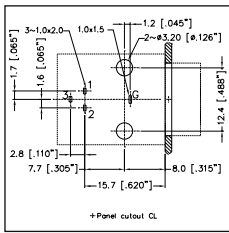

AG3FCCH

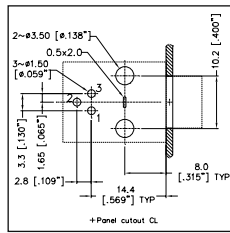

AG3MCCCH

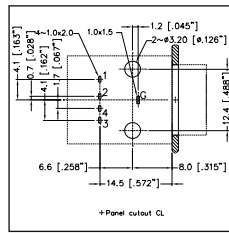

AG4FCCH

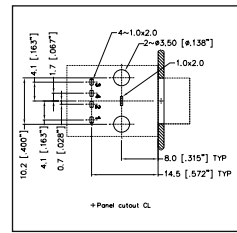

AG4MCCCH

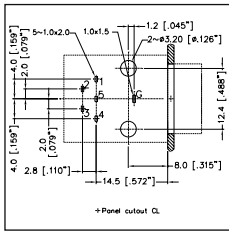

AG5FCCH

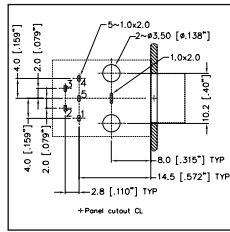

AG5MCCCH

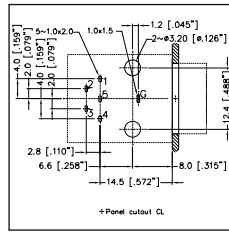

AG6FCCH

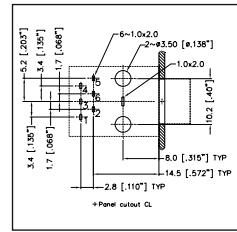

AG6MCCCH

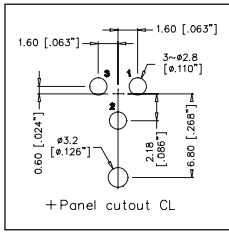

AG3FCRV

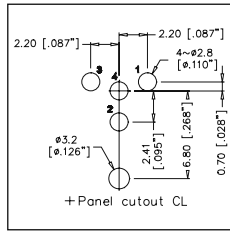

AG4FCRV

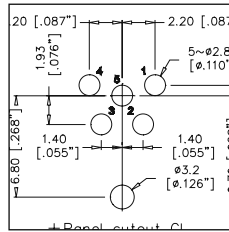

AG5FCRV

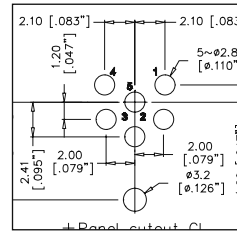

AG6FCRV

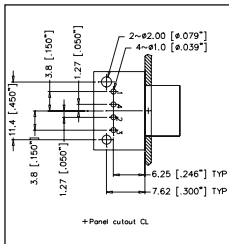

AG4MPCH

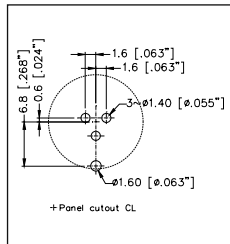

AG3FCE

PANEL CUTOUTS - FRONT VIEW

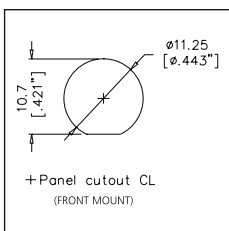

**AG3MCC
AG4MCC
AG5MCC
AG6MCC**

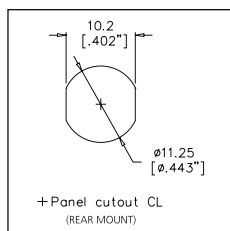

**AG3MCCCH
AG4MCCCH
AG5MCCCH
AG6MCCCH
AG4MPCH**

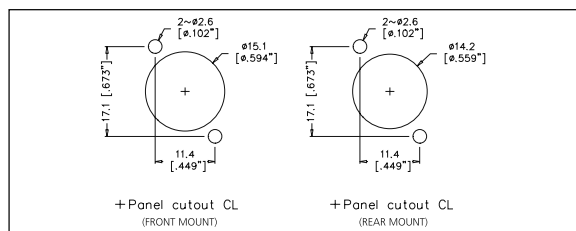

**AG3FCRV
AG4FCRV
AG5FCRV
AG6FCRV**



MULTIPIN CONNECTORS

Amphenol has an extensive range of circular and rectangular multi-pin connectors ideally suited to the entertainment industry. Featuring rugged housings and precision made contacts these connectors have proven themselves in the most demanding of applications. The extensive arrangement of different connector sizes and contact numbers ensure we can offer a solution to your multi-pin wiring applications.

Applications

- Audio Cables and Snakes
- Lighting control
- Concert Touring Systems
- Outside Broadcast Systems

Features / Options - MP-41 Series

- 13 to 85 pins with Crimp / Solder bucket contacts
- 150 pins with Crimp contacts only
- 4 to 48 channel
- Gold plated contacts
- Synthetic inserts
- Environmental resistant
- Positive Bayonet locking
- PG cable gland
- 2000 mating cycles
- Bayonet wear pins
- Extended coupling ring
- Metal Housings

Features / Options - MP-62 Series

- 39 or 61 Solder bucket contacts
- Gold plated contacts
- Neoprene inserts
- Environmental resistant
- Positive Bayonet locking
- PG cable gland or NPT thread
- Metal Housings

Ordering Codes

We have listed the more common ordering codes in each section. For further options please contact us.

Simple steps to guide you in using this catalogue

- 1) Identify the product group listed in Contents on page 1 and go directly to that page number.
- 2) Each product group cover page then details information and options available.
- 3) Refer to the product detail pages and identify the product you require pictorially.
- 4) Read the product description column for the products standard features.
- 5) Use pins column to determine number of contacts.
- 6) Identify part number.
- 7) In the event the particular option you require is not listed please refer to the part number breakdown page at the end of each section.
- 8) Please contact us directly if you have any further problems.



Amphenol's MP-41 series of multipin connectors utilise the same design principals of the rugged Mil-C-5015 military connectors. They can withstand high shock and vibration environments and are ideal for tough on-road applications. Featuring a quick mating bayonet coupling with an audible full mating feature ensures a positive connection every time. Available from 13 to 150 pins with contacts supplied with each connector as standard.



Features:

- 13 to 85 pins with Crimp/Solder bucket contacts
- 150 pins with Crimp contacts only
- 4 to 48 channels
- Gold plated contacts
- Synthetic insert
- Protective dust caps
- Industry standard compatible
- 2000 mating cycles
- Black finish
- Positive bayonet locking
- PG cable glands
- IP67 rated
- Metal housings

Options: NPT threaded backshells.

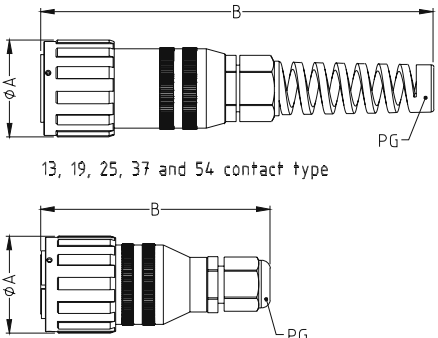
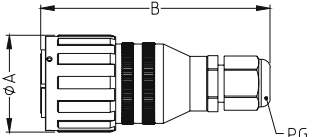

Specifications: Page 127 **Part Number Breakdown:** Page 126 **Wiring Information:** Page 136

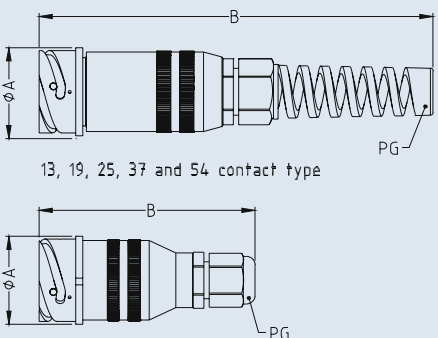
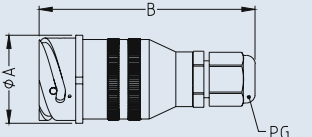

Crimp Tooling: Page 126

PRODUCT - FIGURE	Dimensions in mm (inches) DRAWING	Dimensions in mm (inches)			PINS	PART NUMBER	PART NUMBER With Dustcap
		A	B	PG			
	Straight cable plug with socket contacts, Black finish, supplied complete with contacts.  13, 19, 25, 37 and 54 contact type  85 and 150 contact type	40.5 (1.60)	160 (6.30)	11	13	MP-4106-13S	MP-4106-13S-C
		44 (1.73)	171 (6.73)	13.5	19	MP-4106-19S	MP-4106-19S-C
		46.6 (1.83)	193 (7.60)	16	25	MP-4106-25S	MP-4106-25S-C
		54.3 (2.14)	210 (8.26)	21	37	MP-4106-37S	MP-4106-37S-C
		60.1 (2.36)	210 (8.26)	21	54	MP-4106-54S	MP-4106-54S-C
		73.3 (2.88)	137 (5.40)	29	85	MP-4106-85S	MP-4106-85S-C
		73.3 (2.88)	145 (5.70)	36	150	MP-4106-150S	MP-4106-150S-C
			Cable connecting receptacle with pin contacts, black finish, supplied complete with contacts.  13, 19, 25, 37 and 54 contact type  85 and 150 contact type	37.8 (1.49)	160 (6.30)	11	13
41.1 (1.62)	171 (6.73)			13.5	19	MP-4101-19P	MP-4101-19P-C
41.5 (1.63)	193 (7.60)			16	25	MP-4101-25P	MP-4101-25P-C
51 (2.00)	210 (8.26)			21	37	MP-4101-37P	MP-4101-37P-C
57.1 (2.25)	210 (8.26)			21	54	MP-4101-54P	MP-4101-54P-C
70 (2.75)	137 (5.40)			29	85	MP-4101-85P	MP-4101-85P-C
70 (2.75)	145 (5.70)			36	150	MP-4101-150P	MP-4101-150P-C

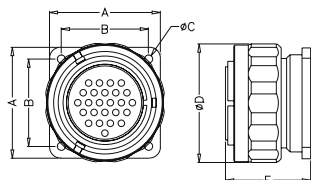
Note: NPT threaded backshells available on request. Please contact us.

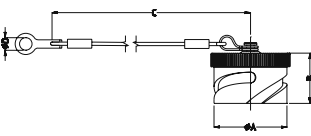

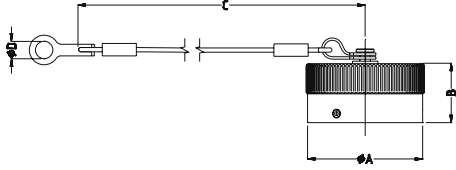
PRODUCT - FIGURE	Dimensions in mm (inches) DRAWING	Dimensions in mm (inches)						PINS	PART NUMBER	PART NUMBER With Dustcap
		A	B	C	D	E	F			
	<p>Panel plug with socket contacts, black finish, supplied complete with contacts.</p> 	38 (1.49)	29.4 (1.15)	3.2 (0.13)	40.5 (1.60)	38.8 (1.53)	N/A	13	MP-4164-13S	MP-4164-13S-C
		41 (1.61)	31.8 (1.25)	3.2 (0.13)	44 (1.73)	38.8 (1.53)	N/A	19	MP-4164-19S	MP-4164-19S-C
		44.5 (1.75)	34.9 (1.37)	3.73 (0.14)	48.51 (1.91)	40.6 (1.60)	N/A	25	MP-4164-25S	MP-4164-25S-C
		50.8 (1.99)	39.7 (1.56)	3.73 (0.14)	54.3 (2.14)	42 (1.65)	N/A	37	MP-4164-37S	MP-4164-37S-C
		57 (2.24)	44.5 (1.75)	4.39 (0.17)	60.8 (2.40)	45 (1.77)	N/A	54	MP-4164-54S	MP-4164-54S-C
		69.8 (2.74)	55.5 (2.18)	4.39 (0.17)	73.3 (2.88)	45 (1.77)	N/A	85	MP-4164-85S	MP-4164-85S-C
		69.8 (2.74)	55.5 (2.18)	4.39 (0.17)	73.3 (2.88)	45 (1.77)	N/A	150	MP-4164-150S	MP-4164-150S-C
		38 (1.49)	29.4 (1.15)	3.23 (0.13)	34.2 (1.34)	34.5 (1.35)	29 (1.14)	13	MP-4102-13P	MP-4102-13P-C
		41 (1.61)	31.8 (1.25)	3.23 (0.13)	37.4 (1.47)	34.5 (1.35)	32.2 (1.26)	19	MP-4102-19P	MP-4102-19P-C
		44.5 (1.75)	34.9 (1.37)	3.73 (0.14)	40.9 (1.61)	35.7 (1.40)	35.3 (1.38)	25	MP-4102-25P	MP-4102-25P-C
50.8 (1.99)	39.7 (1.56)	3.73 (0.14)	46.7 (1.83)	36.5 (1.44)	41.4 (1.62)	37	MP-4102-37P	MP-4102-37P-C		
57 (2.24)	44.5 (1.75)	4.30 (0.17)	53.4 (2.10)	38.5 (1.52)	47.8 (1.88)	54	MP-4102-54P	MP-4102-54P-C		
69.8 (2.74)	55.5 (2.18)	4.30 (0.17)	65.5 (2.57)	38.5 (1.52)	59 (2.32)	85	MP-4102-85P	MP-4102-85P-C		
69.8 (2.74)	55.5 (2.18)	4.30 (0.17)	65.5 (2.57)	38.5 (1.52)	59 (2.32)	150	MP-4102-150P	MP-4102-150P-C		
	<p>Plug protective dustcap to suit MP-4164 type.</p> 	34.16 (1.35)	31.5 (1.24)	110 (4.33)	4.7 (0.18)	-	-	13	MP-25042-13S	-
		37.36 (1.47)	31.5 (1.24)	110 (4.33)	4.7 (0.18)	-	-	19	MP-25042-19S	-
		40.87 (1.61)	31.5 (1.24)	110 (4.33)	4.7 (0.18)	-	-	25	MP-25042-25S	-
		46.68 (1.84)	31.5 (1.24)	110 (4.33)	4.7 (0.18)	-	-	37	MP-25042-37S	-
		53.36 (2.10)	31.5 (1.24)	110 (4.33)	5.5 (0.22)	-	-	54	MP-25042-54S	-
		65.48 (2.58)	31.5 (1.24)	110 (4.33)	5.5 (0.22)	-	-	85	MP-25042-85S	-
		65.48 (2.58)	31.5 (1.24)	110 (4.33)	5.5 (0.22)	-	-	150	MP-25042-150S	-
		38.8 (1.53)	20.7 (0.81)	255 (8.07)	-	-	-	13	MP-25042-13L	-
41.6 (1.64)	20.7 (0.81)	255 (8.07)	-	-	-	19	MP-25042-19L	-		
45.3 (1.78)	20.7 (0.81)	255 (8.07)	-	-	-	25	MP-25042-25L	-		
52.15 (2.05)	20.7 (0.81)	255 (8.07)	-	-	-	37	MP-25042-37L	-		
58.6 (2.30)	20.7 (0.81)	255 (8.07)	-	-	-	54	MP-25042-54L	-		
70.7 (2.78)	20.7 (0.81)	255 (8.07)	-	-	-	85	MP-25042-85L	-		
70.7 (2.78)	20.7 (0.81)	255 (8.07)	-	-	-	150	MP-25042-150L	-		

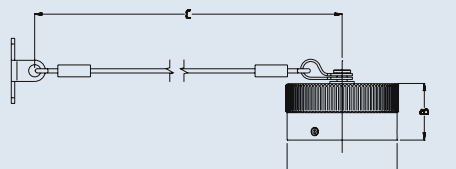
PRODUCT - FIGURE	Dimensions in mm (inches) DRAWING	Dimensions in mm (inches)						PINS	PART NUMBER
		A	B	C	D	E	F		
	<p>Plug protective dustcap to suit MP-4102 types.</p> 	34.16 (1.35)	31.5 (1.24)	110 (4.33)	4.7 (0.18)	-	-	13	MP-25043-13S
		37.36 (1.47)	31.5 (1.24)	110 (4.33)	4.7 (0.18)	-	-	19	MP-25043-19S
		40.87 (1.61)	31.5 (1.24)	110 (4.33)	4.7 (0.18)	-	-	25	MP-25043-25S
		46.68 (1.84)	31.5 (1.24)	110 (4.33)	4.7 (0.18)	-	-	37	MP-25043-37S
		53.36 (2.10)	31.5 (1.24)	110 (4.33)	5.5 (0.22)	-	-	54	MP-25043-54S
		65.48 (2.58)	31.5 (1.24)	110 (4.33)	5.5 (0.22)	-	-	85	MP-25043-85S
		65.48 (2.58)	31.5 (1.24)	110 (4.33)	5.5 (0.22)	-	-	150	MP-25043-150S
			<p>Receptacle protective dustcap to suit MP-4101 types.</p> 	38.8 (1.53)	20.7 (0.81)	255 (8.07)	-	-	-
41.6 (1.64)	20.7 (0.81)			255 (8.07)	-	-	-	19	MP-25043-19L
45.3 (1.78)	20.7 (0.81)			255 (8.07)	-	-	-	25	MP-25043-25L
52.15 (2.05)	20.7 (0.81)			255 (8.07)	-	-	-	37	MP-25043-37L
58.6 (2.30)	20.7 (0.81)			255 (8.07)	-	-	-	54	MP-25043-54L
70.7 (2.78)	20.7 (0.81)			255 (8.07)	-	-	-	85	MP-25043-85L
70.7 (2.78)	20.7 (0.81)			255 (8.07)	-	-	-	150	MP-25043-150L



PRODUCT - FIGURE	DRAWING	DESCRIPTION	NO. OF PINS	PART NUMBER
	N/A	Crimp Tool	All	M22520/1-01
	N/A	Positioner / Turret	All	TH29-1
	N/A	Insertion tool	13-85	MP-INS-16
			150	MP-INS-18
	N/A	Extraction tool	All	MP-EXT-16/18
	N/A	Contact Pilot Pin	13-85	MP-GUIDE-16
			150	MP-GUIDE-18
	N/A	Solder/Crimp Pin Contact	13-85 (Size 16)	MP-108400
		Crimp Pin Contact (Soldering of this contact is not recommended)	150 (Size 18)	MP-108300
	N/A	Solder/Crimp Socket Contact	13-85 (Size 16)	MP-108600
		Crimp Socket Contact (Soldering of this contact is not recommended)	150 (Size 18)	MP-108500

NOTE: Complete instructions for providing reliable crimped wire to contact terminations and inserting proprietary contacts in MP-41 Series connectors are available in publication PI523 located on our website www.amphenolaudio.com.

PART NUMBER BREAKDOWN MP-41 SERIES

MULTIPIN CIRCULAR CONNECTORS

E. G. **MP-4106-85S**
 Multipin, **4106** Cable Plug, **85** Contacts, **S** Female Socket Contacts,

SERIES PREFIX	MP	=	Series Prefix
HOUSING TYPE	4101	=	Inline cable connecting receptacle
	4102	=	Panel receptacle
	4106	=	Cable plug
	4164	=	Panel plug
	25042S	=	Dustcap for panel plug
	25042L	=	Dustcap for cable plug
	25043S	=	Dustcap for panel receptacle
25043L	=	Dustcap for cable receptacle	
NO. OF CONTACTS			13, 19, 25, 37, 54, 85, 150
GENDER *Not required for dustcap part numbers	P	=	Male pin contacts
	S	=	Female socket contacts
OPTIONS	C	=	Supplied with Dustcap

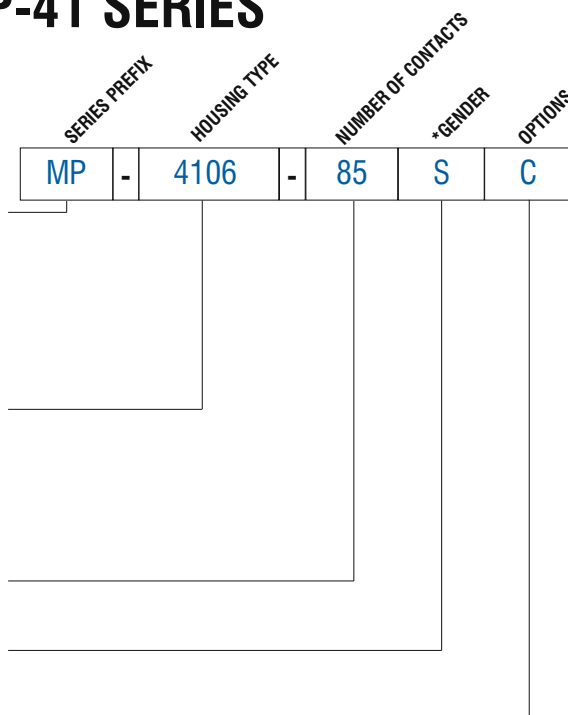

STANDARD DATA MP-41 SERIES

		VALUE						
GENERAL CHARACTERISTICS	Number of contacts	13	19	25	37	54	85	150
	Number of channels	4	6	8	12	16	28	48
	Termination	Solder / Crimp "Combo"						Crimp
	Wire Gauge - Stranded Wire	16AWG - 20AWG						18AWG
	Environmental	Complies with EU RoHS 2 Directive 2011/65/EU						
ELECTRICAL CHARACTERISTICS	Operating Voltage at Sea level - DC	250V*						250V*
	Operating Voltage at Sea level - AC	200V*						200V*
	Test Voltage AC RMS	1000V						1000V
	Current Carrying Capacity	13A						7.5A
	Typical Contact Resistance	3.46mΩ						11.25mΩ
	Insulation Resistance	5000MΩ						
CLIMATIC CHARACTERISTICS	Protection Class	IP67 (when mated)						
	Operating Temperature	-55°C to +125°C (-67°F to +257°F)						
MECHANICAL CHARACTERISTICS	Cable Retention	PG Gland						
	Mechanical Operations	2000 mating cycles						
MATERIALS	Connector / Shell Finish	Aluminium Alloy / Black						
	Insert	Synthetic Insert to MIL-R-3065						
	Male pin contact / Plating	Brass / Gold plated						
	Female socket contact / Plating	Brass / Gold plated						
CLAMPING CHARACTERISTICS	PG Gland	11	13.5	16	21	29	36	
	Cable Clamping range	mm	4-10	5-12	9-14	13-18	14-25	19-32
	(inches)	(0.15"-0.39")	(0.19"-0.47")	(0.35"-0.55")	(0.51"-0.70")	(0.55"-0.98")	(0.74"-1.25")	

Rev 2 - 03/2013

*Not suitable for domestic applications above 50V











Amphenol's Multipin MP-62 series of circular connectors utilise the same design principles as the Mil-C-26482 military connectors. Featuring a three point quick mating bayonet coupling and five key polarisation ensuring a positive connection every time. Available in two contact pin layouts 39 and 61 with gold plated solder contacts fitted as standard.



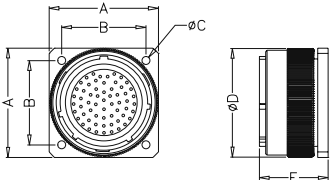

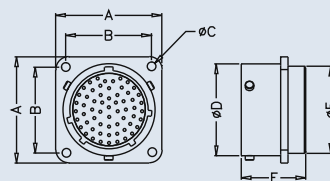

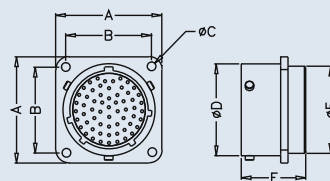

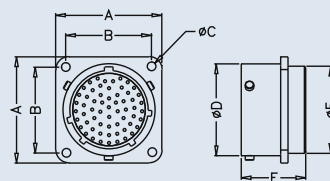

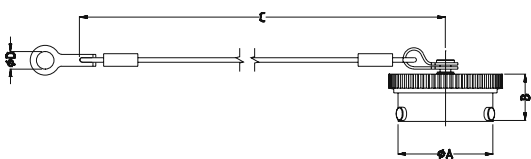

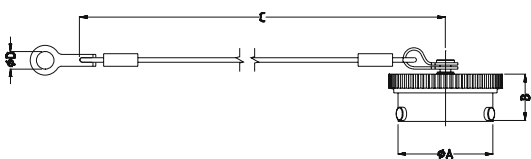

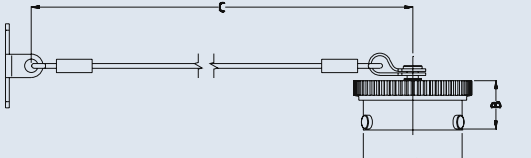
Features:

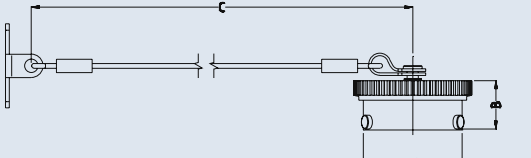
- 39 or 61 pins.
- Gold plated solder contacts.
- Neoprene insert.
- Protective dust caps
- Metal housings
- Environmental resistant.
- Black finish.
- Positive bayonet locking
- PG cable glands

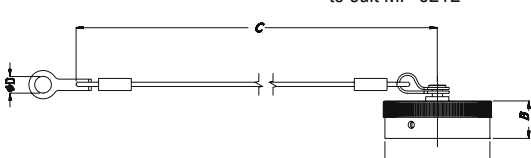
Specifications: Page 130 Wiring Info: Page 135

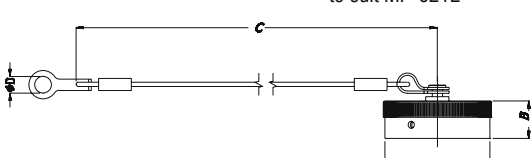
PRODUCT - FIGURE	Dimensions in mm (inches) DRAWING	Dimensions in mm (inches)			PINS	PART NUMBER	PART NUMBER With Dustcap
		A	B	PG			
	<p>Straight cable plug with pin contacts, Black finish, Gold plated solder contacts.</p>	38.9	181.5	16	39	MP-6216-39P	MP-6216-39P-C
		(1.53)	(7.15)				
	<p>Cable connecting receptacle with socket contacts, Black finish, Gold plated solder contacts.</p>	45.5	193	21	61	MP-6216-61P	MP-6216-61P-C
		(1.80)	(7.60)				
	<p>Cable connecting receptacle with socket contacts, Black finish, Gold plated solder contacts.</p>	36.7	181.5	16	39	MP-6211-39S	MP-6211-39S-C
		(1.45)	(7.15)				
	<p>Cable connecting receptacle with socket contacts, Black finish, Gold plated solder contacts.</p>	43.0	193	21	61	MP-6211-61S	MP-6211-61S-C
		(1.70)	(7.60)				
	<p>Straight cable plug with pin contacts, NPT 3/4" threaded backshell, Black finish, Gold plated solder contacts.</p>	38.9	90	NPT	39	MP-6516-39P	MP-6516-39P-C
		(1.53)	(3.54)	3/4"			
	<p>Cable connecting receptacle with socket contacts, NPT 3/4" threaded backshell, Black finish, Gold plated solder contacts.</p>	45.5	100	NPT	61	MP-6516-61P	MP-6516-61P-C
		(1.80)	(3.94)	3/4"			
	<p>Straight cable plug with pin contacts, NPT 3/4" threaded backshell, Black finish, Gold plated solder contacts.</p>	36.7	90	NPT	39	MP-6511-39S	MP-6511-39S-C
		(1.45)	(3.54)	3/4"			
	<p>Cable connecting receptacle with socket contacts, NPT 3/4" threaded backshell, Black finish, Gold plated solder contacts.</p>	43.0	100	NPT	61	MP-6511-61S	MP-6511-61S-C
		(1.70)	(3.94)	3/4"			

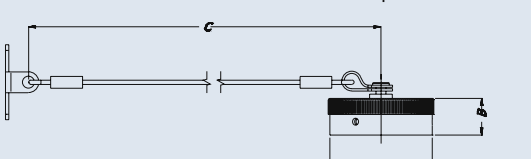
PRODUCT - FIGURE	Dimensions in mm (inches) DRAWING	Dimensions in mm (inches)						PINS	PART NUMBER	PART NUMBER With Dustcap
		A	B	C	D	E	F			
	Panel plug with pin contacts, Black finish, Gold plated solder contacts. 	38.86	29.36	6-32	39.0	32	-	39	MP-6256-39P	MP-6256-39P-C
		(1.53)	(1.16)	UNC	(1.54)	(1.26)	-			
	Panel receptacle plug with socket contacts, Black finish, Gold plated solder contacts. 	43.94	34.93	6-32	45.5	35	-	61	MP-6256-61P	MP-6256-61P-C
		(1.73)	(1.38)	UNC	(1.80)	(1.38)	-			
	Panel receptacle plug with socket contacts, Black finish, Gold plated solder contacts. 	36.7	29.36	3.05	31.8	22.3	30.1	39	MP-6212-39S	MP-6212-39S-C
		(1.44)	(1.15)	(0.12)	(1.25)	(0.87)	(1.18)			
	Panel receptacle plug with socket contacts, Black finish, Gold plated solder contacts. 	43.0	34.93	3.74	38.1	22.3	36.4	61	MP-6212-61S	MP-6212-61S-C
		(1.69)	(1.38)	(0.15)	(1.50)	(0.87)	(1.43)			

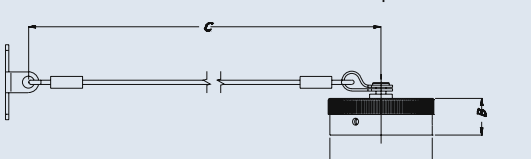
PRODUCT - FIGURE	DRAWING Dimensions in mm (inches)	DESCRIPTION	Dimensions in mm (inches)				PINS	PART NUMBER
			A	B	C	D		
		Plug protective dustcap to suit MP-6256	31.7	15.9	127	4.40	39	MP-742-39S
			(1.25)	(0.62)	(4.99)	(0.17)		
		Plug protective dustcap to suit MP-6256	38.05	16.70	127	4.40	61	MP-742-61S
			(1.50)	(0.66)	(4.99)	(0.17)		
		Receptacle protective dustcap to suit MP-6216	36.9	13.13	127	-	39	MP-742-39L
			(1.45)	(0.52)	(4.99)	-		
		Receptacle protective dustcap to suit MP-6216	43.14	14.15	127	-	61	MP-742-61L
			(1.70)	(0.56)	(4.99)	-		
		Plug protective dustcap to suit MP-6212	31.7	15.9	127	4.40	39	MP-738-39S
			(1.25)	(0.62)	(4.99)	(0.17)		
		Plug protective dustcap to suit MP-6212	38.05	16.70	127	4.40	61	MP-738-61S
			(1.50)	(0.66)	(4.99)	(0.17)		
		Receptacle protective dustcap to suit MP-6211	36.9	13.13	127	-	39	MP-738-39L
			(1.45)	(0.52)	(4.99)	-		
		Receptacle protective dustcap to suit MP-6211	43.14	14.15	127	-	61	MP-738-61L
			(1.70)	(0.56)	(4.99)	-		



STANDARD DATA MP-62 SERIES / MP - 65 SERIES

		VALUE	
GENERAL CHARACTERISTICS	Number of contacts	39	61
	Number of channels	12	20
	Termination	Solder	
	Wire Gauge - Stranded Wire	37 x 24AWG-20AWG 2 x 20AWG-16AWG	24AWG-20AWG
	Environmental	Complies with EU RoHS 2 Directive 2011/65/EU	
ELECTRICAL CHARACTERISTICS	Operating Voltage at Sea level - DC	600V*	
	Operating Voltage at Sea level - AC	600V*	
	Test Voltage AC RMS	1500V	
	Current Carrying Capacity	37 x 7.5A 2 x 13A	7.5A
	Insulation Resistance	5000MΩ	
CLIMATIC CHARACTERISTICS	Protection Class	IP67 (when mated)	
	Operating Temperature	-55°C to +125°C (-67°F to +257°F)	
MECHANICAL CHARACTERISTICS	Cable Retention	PG Gland / NPT Thread	
	Mechanical Operations	500 mating cycles (minimum)	
MATERIALS	Connector / Shell Finish	Aluminium Alloy / Black	
	Insert	Neoprene	
	Male pin contact machined - Plating	Brass / Gold plated	
	Female socket contact machined - Plating	Brass / Gold plated	
CLAMPING CHARACTERISTICS	PG Gland	16	21
	Cable Clamping range mm (inches)	9-14 (0.35"-0.55")	13-18 (0.51"-0.70")

*Not suitable for domestic applications above 50V

Rev 3 - 03/2013





146 SERIES RECTANGULAR CONNECTORS

Amphenol Tuchel C146 series rectangular connectors feature modular components ensuring a vast range of different features and benefits for the end user. The zinc diecast aluminum housings are finished in a durable powder coat and available in either top or side entry. Connector coupling is achieved via a positive locking lever ensuring a positive rapid connection. The C146 series is suitable for general-purpose audio and lighting applications and is completely intermateable with all competitor connectors.



FIBRE OPTIC

Amphenol has over 25 years experience in fibre optics dating back to their development of the first industry standard connector, the SMA. Today we can offer a complete range of products including Hybrid Fibre optic connectors for HDTV broadcast cameras SMPTE 304M compliant and ruggedised connectors and cable assemblies for indoor or outdoor applications.



Amphenol

AC SERIES

ACCESSORIES



ACCESSORIES

- Colour coded boots(backshells) and rings to assist in cable identification.
- In-line adaptors. Pre-wired for convenience.
- Termination tool for fast assembly of cable connectors.
- Mounting hardware.
- Metal boots(backshells) for rugged environments.

PRODUCT - FIGURE	DRAWING	Dimensions in mm (inches)	DESCRIPTION	VARIATIONS	PART NUMBER
		60.4 [2.378"] ø19.0 [ø.748"]	XLR 3 pole male to 3 pole male adapter, Pre wired, Metal Shell	Nickel Finish Black Finish	AC3M3MW AC3M3MBW
		60.4 [2.378"] 66.5 [2.616"] ø19.0 [ø.748"]	XLR 3 pole female to 3 pole female adapter, Pre wired, Metal Shell	Nickel Finish Black Finish	AC3F3FW AC3F3FBW
		60.4 [2.378"] 73.5 [2.892"] ø19.0 [ø.748"]	XLR 3 pole female to 3 pole male adapter, Pre wired, Metal Shell	Nickel Finish Black Finish	AC3F3FBW AC3F3MBW
		62.5 [2.461"] 75.7 [2.980"] ø18.9 [ø.744"]	XLR 3 pole female to 5 pole male adapter, Pre wired, Metal Shell	Nickel Finish	AC3F5MW
		62.5 [2.461"] 75.7 [2.980"] ø18.9 [ø.744"]	XLR 3 pole male to 5 pole female adapter, Pre wired, Metal Shell	Nickel Finish	AC3M5FW
		76 [2.991"] ø19 [ø.748"]	XLR 5 pole male to 5 pole male adapter, Pre wired, Metal Shell	Nickel Finish	AC5M5MW
		29 34 75	XLR D shell adapter, 3 pole male to 3 pole male, Pre-wired	Not Applicable	AC3M3MDW
		29 34 75	XLR D shell adapter, 3 pole female to 3 pole female, Pre-wired	Not Applicable	AC3F3FDW
		29 34 75	XLR D shell adapter, 3 pole female to 3 pole male, Pre-wired	Not Applicable	AC3F3MDW
		29 34 75	XLR D shell adapter, 5 pole male to 5 pole male, Pre-wired	Not Applicable	AC5M5MDW
		29 34 75	XLR D shell adapter, 5 pole female to 5 pole female, Pre-wired	Not Applicable	AC5F5FDW

ACC.







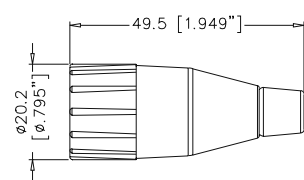

Amphenol

AC SERIES

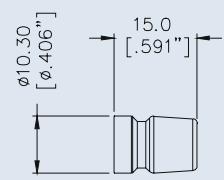
ACCESSORIES

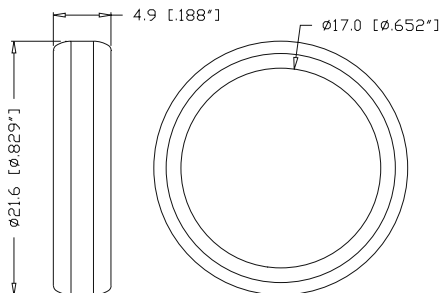
PRODUCT - FIGURE	DRAWING	Dimensions in mm (inches)	DESCRIPTION	VARIATIONS	PART NUMBER
			XLR D shell adapter, 5 pole female to 5 pole male, Pre-wired	Not Applicable	AC5F5MDW
			SP D shell adapter, SP-2 to SP-2, Pre-wired	Not Applicable	SP2F2FDW
			SP D shell adapter, SP-4 to SP-4, Pre-wired	Not Applicable	SP4F4FDW
			BNC D shell adapter, Jack to Jack, Pre-wired	Not Applicable	ACBNCJJDW
			D shell adapter without connectors	Not Applicable	AC-D-ADAPTER
			Termination Tool	For IDC and Solder cable connectors	T2860
			Termination Tool	For AC Series Right Angle cable connectors	T2880
			Termination Tool	For AX Series cable connectors	T2890
			A Type / C Type Connector Mounting, Self-Tapping Screw	2.9 x 1.06 Tri-rondular	52500014-734
			B Type / XLRnet Connector Mounting, Self-Tapping Screw	M2.5	52500005-732
			AX Series Coloured Boot	Brown	AX-BOOT-1
				Red	AX-BOOT-2
				Orange	AX-BOOT-3
				Yellow	AX-BOOT-4
				Green	AX-BOOT-5
				Blue	AX-BOOT-6
				Violet	AX-BOOT-7
				Grey	AX-BOOT-8
				White	AX-BOOT-9
				Black	AX-BOOT
			Clear	AX-BOOT-CLR	

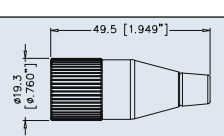
ACC.

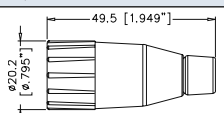
PRODUCT - FIGURE	DRAWING Dimensions in mm (inches)	DESCRIPTION	VARIATIONS	PART NUMBER
	 <p>49.5 [1.949"] ø20.2 [ø.795"]</p>	AC Coloured Boot / Backshell Note: Number Identification optional. (Please contact us.)	Brown	AC-NUT-BRN
			Red	AC-NUT-RED
			Orange	AC-NUT-ORG
			Yellow	AC-NUT-YEL
			Green	AC-NUT-GRN
			Blue	AC-NUT-BLU
			Violet	AC-NUT-VIO
			Grey	AC-NUT-GRY
			White	AC-NUT-WHT
	 <p>ø10.30 [ø.406"] 15.0 [.591"]</p>	Coloured Grommets to suit AC Series, T Series and Musician range	Brown	AC-GROMMET-BRN
			Red	AC-GROMMET-RED
			Orange	AC-GROMMET-ORG
			Yellow	AC-GROMMET-YEL
			Green	AC-GROMMET-GRN
			Blue	AC-GROMMET-GRN
			Violet	AC-GROMMET-VIO
			Grey	AC-GROMMET-GRY
			White	AC-GROMMET-WHT
	 <p>4.9 [188"] ø21.6 [ø.829"] ø17.0 [ø.652"]</p>	AC Coloured Identification Rings – Plain and Numbered Note: Custom number Identification optional. (Please contact us.)	Brown	AC-RING-BRN
			Red	AC-RING-RED
			Orange	AC-RING-ORG
			Yellow	AC-RING-YEL
			Green	AC-RING-GRN
			Blue	AC-RING-BLU
			Violet	AC-RING-VIO
			Grey	AC-RING-GRY
			White	AC-RING-WHT
			Red #1-24	AC-RING-RED-PK1
			Yellow #1-24	AC-RING-YEL-PK1
			Blue #1-24	AC-RING-BLU-PK1
			Red #1-48	AC-RING-RED-PK2
Yellow #1-48	AC-RING-YEL-PK2			
Blue #1-48	AC-RING-BLU-PK2			
	 <p>49.5 [1.949"] ø19.3 [ø.760"]</p>	AC Metal Boot / Backshell, Black Finish	Not Applicable	AC-NUT-METAL
	 <p>49.5 [1.949"] ø20.2 [ø.795"]</p>	AC Thermoplastic Boot / Backshell. Suitable for use with 8.5mm (0.33") O.D. cable.	Not Applicable	AC-NUT-J-BLK

ACC.

NOTE: All accessories comply with EU RoHS 2 Directive 2011/65/EU
 NOTE: Please do not refer to this printed catalogue as a colour reference. For exact colours contact your sales representative.

CONNECTOR WIRING INFORMATION

XLR (Microphone / Patch Cables)

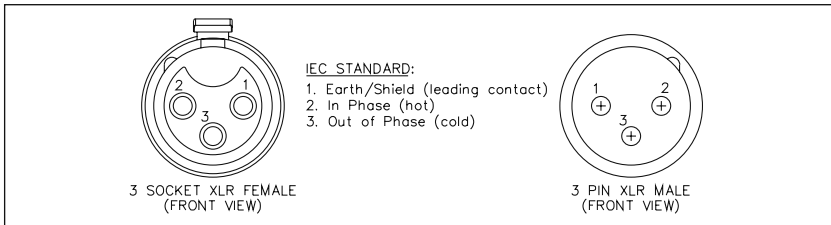

The standard XLR 3 contact pin outs are as shown above for a balanced lead. In such a configuration audio "Hot" (pin 2) is the in-phase connection whilst audio "Cold" (pin 3) is the out-of-phase connection. For an unbalanced lead however, you may connect pin 1 to either pin 2 or pin 3, but not both. In such a configuration the remaining pin is used for the audio signal.

When terminating the cable shielding to pin 1 it is suggested that the shield be only grounded at one end of the cable to avoid inducing "hum". Pin 1 is a leading contact that engages at interconnection, before pin 2 or pin 3.

1/4" Phono (6.35mm) (Standard Applications)

MICROPHONE CABLE - BALANCED

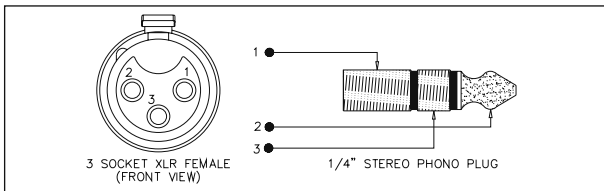

MICROPHONE CABLE - UNBALANCED

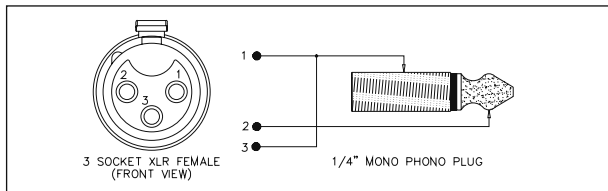

INSTRUMENT / LINE CABLE (MONO)

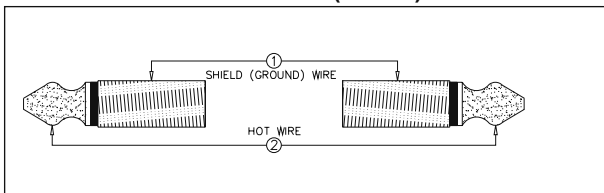

INSTRUMENT / LINE CABLE (STEREO)

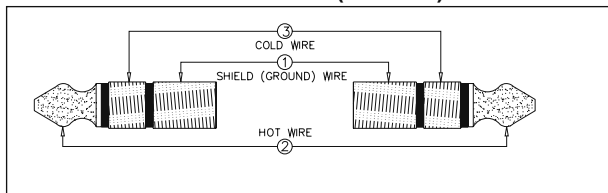

CONNECTOR WIRING INFORMATION

MP Series

MP-41 Series
4 Ch - 13 pin

Ch	+	-	G
1	B	C	E
2	F	K	H
3	J	D	A
4	N	M	G
General			
Ground	L		

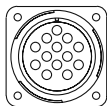

MP-41 Series
6 Ch - 19 pin

Ch	+	-	G
1	L	M	U
2	A	N	B
3	K	J	T
4	V	P	C
5	H	S	G
6	R	D	E
General			
Ground	F		

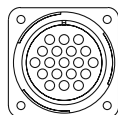

MP-41 Series
8 Ch - 25 pin

Ch	+	-	G
1	A	E	F
2	G	C	B
3	D	H	J
4	M	L	K
5	Q	P	N
6	W	S	R
7	T	X	Y
8	Z	V	U
General			
Ground	a		

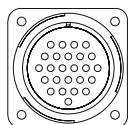

MP-41 Series
12 Ch - 37 pin

Ch	+	-	G
1	E	F	A
2	B	C	G
3	H	J	D
4	S	T	K
5	L	M	U
6	V	W	N
7	P	R	X
8	a	b	g
9	c	d	j
10	e	f	m
11	n	p	h
12	r	s	k
General			
Ground	z		

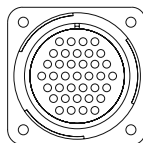

MP-41 Series
16 Ch - 54 pin

Ch	+	-	G
1	W	f	r
2	J	R	a
3	k	v	AC
4	E	M	V
5	e	q	y
6	B	H	P
7	Z	j	u
8	D	L	U
9	d	p	x
10	A	G	O
11	Y	h	t
12	C	K	T
13	c	n	w
14	F	N	X
15	g	s	AB
16	S	b	m
General			
Ground	AG		

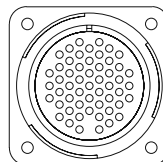

MP-41 Series
28 Ch - 85 pin

Ch	+	-	G
1	A	B	C
2	E	F	H
3	J	K	L
4	N	P	R
5	S	T	U
6	X	Y	Z
7	a	b	c
8	d	f	g
9	h	i	j
10	k	m	n
11	p	q	r
12	t	u	v
13	w	x	y
14	z	AA	AB
15	AC	AD	AE
16	AF	AH	AJ
17	AK	AL	AM
18	AP	AR	AS
19	AT	AU	AV
20	AW	AX	AY
21	AZ	BA	BB
22	BC	BD	BE
23	BJ	BK	BL
24	BM	BN	BP
25	BS	BT	BU
26	BV	BR	BF
27	BH	AN	s
28	W	M	D
General			
Ground	V		

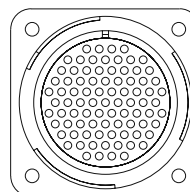

MP-41 Series
48 Ch - 150 pin

Ch	+	-	G
1	1	2	3
2	5	6	7
3	8	9	10
4	11	12	13
5	14	15	16
6	17	18	19
7	21	22	23
8	24	25	26
9	27	28	29
10	20	30	31
11	32	33	34
12	35	36	37
13	38	39	40
14	41	42	43
15	44	45	46
16	47	48	49
17	50	51	52
18	53	54	55
19	57	58	59
20	60	61	62
21	63	64	65
22	66	67	68
23	69	70	71
24	72	73	74
25	75	76	77
26	78	79	80
27	82	83	84
28	85	86	87
29	88	89	90
30	91	92	93
31	94	95	96
32	97	98	99
33	100	101	102
34	103	104	105
35	56	81	106
36	107	108	109
37	110	111	112
38	113	114	115
39	116	117	118
40	119	120	121
41	122	123	124
42	125	126	127
43	139	128	129
44	130	131	132
45	133	134	135
46	136	137	138
47	140	141	142
48	143	144	145
General			
Ground	150		

MP-62 Series
12 Ch - 39 pin

Ch	+	-	G
1	p	n	q
2	W	A	X
3	N	f	P
4	L	e	M
5	J	d	K
6	G	c	H
7	E	b	F
8	D	a	Z
9	C	B	Y
10	U	j	V
11	i	h	T
12	R	g	S
General			
Ground	N/A		

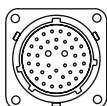

MP-62 Series
20 Ch - 61 pin

Ch	+	-	G
1	JJ	HH	NN
2	MM	KK	PP
3	BB	AA	CC
4	s	FF	W
5	r	EE	V
6	e	D	x
7	f	E	y
8	q	DD	U
9	S	p	T
10	P	N	R
11	m	k	n
12	L	K	M
13	J	i	j
14	H	G	h
15	g	F	z
16	d	C	w
17	B	A	c
18	b	a	Z
19	v	u	Y
20	t	GG	X
General			
Ground	N/A		

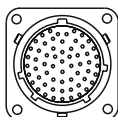

Symbols	AC3FDZB-AU	19	AC4FB BULK	12	AC5MPB	23	AC-BNC20BP75	84
47-10070	AC3FDZB BULK	19	AC4FBJ	12	AC5MPNZ	23	AC-BNC20M	84
47-10090	AC3FDZ BULK	19	AC4F BULK	12	AC5MPNZB	23	AC-BNC20MJ75	84
47-10110	AC3FJ	11	AC4FDZ	20	AC6AF	13	AC-BNC20MP75	84
47-10120	AC3FPZ	22	AC4FDZ-AU	20	AC6AF-AU	13	AC-BNC40A	84
47-10150	AC3FPZB	22	AC4FDZB	20	AC6AFB	13	AC-BNC40AJ75	84
112119	AC3M	11	AC4FDZB-AU	20	AC6AFB-AU	13	AC-BNC40AP75	84
112133	AC3M3MBW	132	AC4FDZB BULK	20	AC6AFB BULK	13	AC-BNC40B	84
112133	AC3M3MDW	132	AC4FDZ BULK	20	AC6AFBJ	13	AC-BNC40BJ75	84
112507	AC3M3MW	132	AC4FDZV	20	AC6AF BULK	13	AC-BNC40BP75	84
112508	AC3M5FW	132	AC4FDZVB	20	AC6AFDZ	21	AC-BNC40M	84
112509	AC3MA-AU-PRE	30	AC4FJ	12	AC6AFDZ-AU	21	AC-BNC40MJ75	84
112519	AC3MAH1-AU-PRE	29	AC4FPZ	23	AC6AFDZB	21	AC-BNC40MP75	84
112521	AC3MAH2-AU-PRE	29	AC4FPZB	23	AC6AFDZB-AU	21	AC-BNC-JJ-75	83
112565	AC3MAH4-SW-B	29	AC4M	12	AC6AFDZB BULK	21	AC-BNC-JJ-75B	83
112606	AC3MAH-AU-PRE	29	AC4M-AU	12	AC6AFDZ BULK	21	AC-BNC-JJA-75T	83
112950	AC3M-AU	11	AC4MB	12	AC6AFDZV	21	ACBNCJJDW	133
112951	AC3MAV2-AU-PRE	30	AC4MB-AU	12	AC6AFDZVB	21	AC-BNC-JS-75	83
112952	AC3MAV-AU-PRE	29	AC4MB BULK	12	AC6AFJ	13	AC-BNC-JS-75B	83
112953	AC3MB	11	AC4MBJ	12	AC6AFPZ	23	AC-BNC-LABEL	84
112955	AC3MB-AU	11	AC4M BULK	12	AC6AFPZB	23	AC-BNC-PJ-75	83
112956	AC3MB BULK	11	AC4MDZ	20	AC6AM	13	AC-BNC-PJ-75B	83
112957	AC3MBH1-AU-B	32	AC4MDZ-AU	20	AC6AM-AU	13	AC-BNC-PJA-75T	83
52500002-734	AC3MBH2-AU-B	32	AC4MDZB	20	AC6AMB	13	AC-D-ADAPTER	133
52500005-732	AC3MBH3-AU-B	32	AC4MDZB-AU	20	AC6AMB-AU	13	AC-GROMMET-BRN	134
	AC3MBH-AU-B	32	AC4MDZB BULK	20	AC6AMB BULK	13	AC-GROMMET-GRN	134
A	AC3MBHL-AU-B	32	AC4MDZV	20	AC6AMB BULK	13	AC-GROMMET-GRY	134
	AC3MBJ	11	AC4MDZVB	20	AC6AMBJ	13	AC-GROMMET-ORG	134
	AC3M BULK	11	AC4MJ	12	AC6AMDZ	21	AC-GROMMET-RED	134
AC3F	AC3MBV1-AU-B	33	AC4MP	23	AC6AMDZ-AU	21	AC-GROMMET-VIO	134
AC3F3FBW	AC3MBV2-AU-B	33	AC4MPB	23	AC6AMDZB	21	AC-GROMMET-WHT	134
AC3F3FDW	AC3MBV3-AU-B	33	AC4MPNZ	22	AC6AMDZB-AU	21	AC-GROMMET-YEL	134
AC3F3FW	AC3MBV-AU-B	32	AC4MPNZB	22	AC6AMDZB BULK	21	ACJC5H BULK	46
AC3F3MBW	AC3MCP	15	AC5F	12	AC6AMDZ BULK	21	ACJC5HL BULK	46
AC3F3MDW	AC3MCP-AU	15	AC5F5FDW	132	AC6AMDZV	21	ACJC5S BULK	46
AC3F5MW	AC3MCP BULK	15	AC5F5MDW	133	AC6AMDZVB	21	ACJC5SL BULK	46
AC3FAH1-AU-PRE	AC3MCPJ	15	AC5FAH-AU-B	36	AC6AMJ	13	ACJC5V BULK	46
AC3FAH2-AU-PRE	AC3MDZ	19	AC5FAH-AU-B	36	AC6AMP	23	ACJC5VL BULK	46
AC3FAH-AU-PRE	AC3MDZ-AU	19	AC5FAV-AU-B	36	AC6AMPB	23	ACJC6AH BULK	44
AC3FAHL1-AU-PRE	AC3MDZB	19	AC5FB	12	AC6AMPNZ	23	ACJC6AHL BULK	44
AC3FAHL2-AU-PRE	AC3MDZB-AU	19	AC5FB-AU	12	AC6AMPNZB	23	ACJC6AV2 BULK	44
AC3FAHL-AU-PRE	AC3MDZB BULK	19	AC5FB BULK	12	AC7F	13	ACJC6AV2L BULK	44
AC3F-AU	AC3MDZ BULK	19	AC5FBJ	12	AC7FB	13	ACJC6AV BULK	44
AC3FAV1-AU-PRE	AC3MJ	11	AC5F BULK	12	AC7FB BULK	13	ACJC6AVL BULK	44
AC3FAV2-AU-PRE	AC3MM	11	AC5FDZ	20	AC7FBJ	13	ACJC6H BULK	47
AC3FAV-AU-PRE	AC3MM-AU	11	AC5FDZ-AU	20	AC7FB BULK	13	ACJC6HL BULK	47
AC3FAVL1-AU-PRE	AC3MMB	11	AC5FDZB	20	AC7FDZ	21	ACJC6S BULK	47
AC3FAVL2-AU-PRE	AC3MMB-AU	11	AC5FDZB-AU	20	AC7FDZB	21	ACJC6SL BULK	47
AC3FAVL-AU-PRE	AC3MMB BULK	11	AC5FDZB BULK	20	AC7FDZB BULK	21	ACJC6V BULK	47
AC3F-AU	AC3MMBJ	11	AC5FDZ BULK	20	AC7FDZ BULK	21	ACJC6VL BULK	47
AC3FB-AU	AC3MM BULK	11	AC5FDZV	20	AC7FDZV	21	ACJC9AH BULK	44
AC3FB BULK	AC3MMCP	15	AC5FDZVB	20	AC7FDZVB	21	ACJC9AHL BULK	44
AC3FBH1-AU-B	AC3MMCP-AU	15	AC5FJ	12	AC7FJ	13	ACJC9AV2 BULK	45
AC3FBH2-AU-B	AC3MMCP BULK	15	AC5FPZ	23	AC7FPZ	24	ACJC9AV2L BULK	45
AC3FBH3-AU-B	AC3MMCPJ	15	AC5FPZB	23	AC7FPZB	24	ACJC9AVL BULK	45
AC3FBH-AU-B	AC3MMDZ	19	AC5M	12	AC7M	13	ACJC9H BULK	47
AC3FBHL1-AU-B	AC3MMDZ-AU	19	AC5M5MDW	132	AC7MB	13	ACJC9HL BULK	47
AC3FBHL2-AU-B	AC3MMDZB	19	AC5M5MDW	132	AC7MB BULK	13	ACJC9S BULK	48
AC3FBHL3-AU-B	AC3MMDZB-AU	19	AC5MAH-AU-B	36	AC7MBJ	13	ACJC9SL BULK	48
AC3FBHL-AU-B	AC3MMDZB BULK	19	AC5M-AU	12	AC7M BULK	13	ACJC9V BULK	48
AC3FBJ	AC3MMDZ BULK	19	AC5MAV-AU-B	36	AC7MDZ	21	ACJC9VL BULK	48
AC3F BULK	AC3MMDZV	19	AC5MB	12	AC7MDZB	21	ACJC10AH BULK	45
AC3FBV1-AU-B	AC3MMDZVB	19	AC5MB-AU	12	AC7MDZB BULK	21	ACJC10AHL BULK	45
AC3FBV2-AU-B	AC3MMJ	11	AC5MB BULK	12	AC7MDZ BULK	21	ACJC10AV2 BULK	45
AC3FBV3-AU-B	AC3MMP	22	AC5MBJ	12	AC7MDZV	21	ACJC10AV2L BULK	45
AC3FBV-AU-B	AC3MMPB	22	AC5M BULK	12	AC7MDZVB	21	ACJC10AV BULK	45
AC3FBVL1-AU-B	AC3MMPNZ	22	AC5MDZ	20	AC7MPJ	13	ACJC10AVL BULK	45
AC3FBVL2-AU-B	AC3MMPNZB	22	AC5MDZ-AU	20	AC7MP	24	ACJC10H BULK	48
AC3FBVL3-AU-B	AC3MP	22	AC5MDZB	20	AC7MPB	24	ACJC10HL BULK	48
AC3FBVL-AU-B	AC3MPNZ	22	AC5MDZB BULK	20	AC7MPNZ	24	ACJC10S BULK	49
AC3FCP	AC3MPNZB	22	AC5MDZ BULK	20	AC7MPNZB	24	ACJC10SL BULK	49
AC3FCP-AU	AC4F	12	AC5MDZV	20	AC-BNC20A	84	ACJC10V BULK	48
AC3FCP BULK	AC4F-AU	12	AC5MDZVB	20	AC-BNC20AJ75	84	ACJC10V BULK	48
AC3FCPJ	AC4FB	12	AC5MJDZ	20	AC-BNC20AP75	84	ACJD-BLK	116
AC3FDZ	AC4FB BULK	12	AC5MJB	12	AC-BNC20B	84	ACJD-BLU	116
AC3FDZ-AU	AC4FB-AU	12	AC5MP	23	AC-BNC20BJ75	84	ACJD-GRN	116
AC3FDZB								

Amphenol

INDEX

ACJD-RED	116	ACJS-MHOP	103	ACPR-BLK	115	AG6F	118	AX-BOOT-8	133
ACJD-WHT	116	ACJS-MHOP-1	103	ACPR-BLU	115	AG6FCCH	118	AX-BOOT-9	133
ACJD-YEL	116	ACJS-MHR	104	ACPR-GRN	115	AG6FCE	118	AX-BOOT-CLR	133
ACJM-HHDR	102	ACJS-MHS	104	ACPR-RED	115	AG6FCRV	119		
ACJM-HHOP	103	ACJS-MIV-3	105	ACPR-SBK	115	AG6FL	118		
ACJM-HHOP-1	103	ACJS-MIV-3S	105	ACPR-SBL	115	AG6M	118	B	
ACJM-IH	104	ACJS-MIV-5	105	ACPR-SGR	115	AG6MCC	118	BNC-U-LINK 75*1	83
ACJM-IHS	104	ACJS-MN-3	105	ACPR-SRD	115	AG6MCCH	118	E	
ACJM-MC	104	ACJS-MN-3S	105	ACPR-SWH	115	AP-4-11	66		
ACJM - MH	103	ACJS-MN-5	105	ACPR-SYL	115	AP-4-12	66		
ACJM-MHD	105	ACJS-MV-3	105	ACPR-WHT	115	AP-4-13	66	EP-3-11P	64
ACJM-MHD985	102	ACJS-MV-3S	105	ACPR-YEL	115	AP-4-14	66	EP-3-11PB	64
ACJM-MHDC*	104	ACJS-MV-5	105	ACPS-GB	98	AP-4-21	66	EP-3-12	64
ACJM-MHDCM	104	ACJS-MV35-3	102	ACPS-GB-AU	98	AP-4-22	66	EP-3-12B	64
ACJM-MHDE	105	ACJS-MV35-3S	102	ACPS-GB BULK	98	AP-5-11	66	EP-3-13P	65
ACJM-MHDEM	105	ACJS-MV35-5	102	ACPS-GN	98	AP-5-12	66	EP-3-13PB	65
ACJM-MHDM	105	ACJS-MVD985-3	102	ACPS-GN-AU	98	AP-5-13	66	EP-3-14	65
ACJM-MHDR	103	ACJS-MVD985-3S	102	ACPS-GN BULK	98	AP-5-14	66	EP-3-14B	65
ACJM-MHDRM	103	ACJS-MVD985-5	102	ACPS-KB	96	AP-5-21	66	EP-4-11P	64
ACJM-MHOM	103	ACJS-MVS-3	106	ACPS-KB-AU	96	AP-5-22	66	EP-4-11PB	64
ACJM-MHOP	103	ACJS-MVS-3S	106	ACPS-KB BULK	96	AP-6-11	66	EP-4-12	64
ACJM-MHOP-1	103	ACJS-MVS-5	106	ACPS-KN	96	AP-6-12	66	EP-4-12B	64
ACJM-MHR	104	ACJS-NH35	102	ACPS-KN-AU	96	AP-6-13	66	EP-4-13P	65
ACJM-MHS	104	ACJS-NV35-3	102	ACPS-KN BULK	96	AP-6-14	66	EP-4-13PB	65
ACJM-MIV-2	105	ACJS-NV35-3S	102	ACPS-RB	99	AP-6-21	66	EP-4-14	65
ACJM-MIV-2S	105	ACJS-NV35-5	102	ACPS-RB-AU	99	AP-6-22	66	EP-4-14B	65
ACJM-MN-2	105	ACJS-PC	104	ACPS-RB BULK	99	AP-8-11	66	EP-5-11P	64
ACJM-MN-2S	105	ACJS - PH	104	ACPS-RN	99	AP-8-12	66	EP-5-11PB	64
ACJM-MV-2	105	ACJS-PHOP	103	ACPS-RN-AU	99	AP-8-13	66	EP-5-12	64
ACJM-MV-2S	105	ACJS-PHOP-1	103	ACPS-RN BULK	99	AP-8-14	66	EP-5-12B	64
ACJM-MV35-2	102	ACJS-PHR	104	ACPS-TB	97	AP-8-21	66	EP-5-13P	65
ACJM-MV35-2S	102	ACJS-PHS	104	ACPS-TB-AU	97	AP-8-22	66	EP-5-13PB	65
ACJM-MVD985-2	102	ACJS-PVB-3	105	ACPS-TB BULK	97	AX3F	4	EP-5-14	65
ACJM-MVD985-2S	102	ACJS-PVB-3S	105	ACPS-TN	97	AX3F-AU	4	EP-5-14B	65
ACJM-MVS-2	106	ACJS-PVB-5	105	ACPS-TN-AU	97	AX3FB	4	EP-6-11P	64
ACJM-MVS-2S	106	AC-NUT-BLU	134	ACPS-TN BULK	97	AX3FB-AU	4	EP-6-11PB	64
ACJM-NH35	102	AC-NUT-BRN	134	AC-RING-BLU	134	AX3FB BULK	4	EP-6-12	64
ACJM-NV35-2	102	AC-NUT-GRN	134	AC-RING-BLU-PK1	134	AX3F BULK	4	EP-6-12B	64
ACJM-NV35-2S	102	AC-NUT-GRY	134	AC-RING-BLU-PK2	134	AX3M	4	EP-6-13P	65
ACJM-PC	104	AC-NUT-J-BLK	134	AC-RING-BRN	134	AX3M-AU	4	EP-6-13PB	65
ACJM - PH	103	AC-NUT-METAL	134	AC-RING-GRN	134	AX3MB	4	EP-6-14	65
ACJM-PHOP	103	AC-NUT-ORG	134	AC-RING-GRY	134	AX3MB-AU	4	EP-6-14B	65
ACJM-PHOP-1	103	AC-NUT-RED	134	AC-RING-ORG	134	AX3MB BULK	4	EP-8-11P	64
ACJM-PHR	104	AC-NUT-VIO	134	AC-RING-RED	134	AX3M BULK	4	EP-8-11PB	64
ACJM-PHS	104	AC-NUT-WHT	134	AC-RING-RED-PK1	134	AX4F	5	EP-8-12	64
ACJM-PVB-2	105	AC-NUT-YEL	134	AC-RING-RED-PK2	134	AX4F-AU	5	EP-8-12B	64
ACJM-PVB-2S	105	ACPL-CBK	115	AC-RING-VIO	134	AX4FB	5	EP-8-13P	65
ACJR-BLK	115	ACPL-CBL	115	AC-RING-WHT	134	AX4FB-AU	5	EP-8-13PB	65
ACJR-BLU	115	ACPL-CGR	115	AC-RING-YEL	134	AX4FB BULK	5	EP-8-14	65
ACJR-GRN	115	ACPL-CRD	115	AC-RING-YEL-PK1	134	AX4F BULK	5	EP-8-14B	65
ACJR-RED	115	ACPL-CWH	115	AC-RING-YEL-PK2	134	AX4M	4		
ACJR-SBK	115	ACPL-CYL	115	AG3F	118	AX4M-AU	4	H	
ACJR-SBL	115	ACPM-GB	98	AG3FCCH	118	AX4MB	5	HP-3-F	62
ACJR-SGR	115	ACPM-GB-AU	98	AG3FCE	118	AX4MB-AU	5	HP-3-FG	62
ACJR-SRD	115	ACPM-GB BULK	98	AG3FCRV	119	AX4MB BULK	5	HP-3-MD	62
ACJR-SWH	115	ACPM-GN	98	AG3FL	118	AX4M BULK	4	HP-3-MDG	62
ACJR-SYL	115	ACPM-GN-AU	98	AG3M	118	AX5F	5	HP-3-MDGW	62
ACJR-WHT	115	ACPM-GN BULK	98	AG3MCC	118	AX5F-AU	5	HP-3-MDW	62
ACJR-YEL	115	ACPM-KB	96	AG3MCCH	118	AX5FB	5		
ACJS-HHDR	102	ACPM-KB-AU	96	AG4F	118	AX5FB-AU	5	J	
ACJS-HHOP	103	ACPM-KB BULK	96	AG4FCCH	118	AX5FB BULK	5		
ACJS-HHOP-1	103	ACPM-KN	96	AG4FCE	118	AX5F BULK	5	JM2P	93
ACJS-IH	104	ACPM-KN-AU	96	AG4FCRV	119	AX5M	5	JM2P-AU	93
ACJS-IHS	104	ACPM-KN-BULK	96	AG4FL	118	AX5M-AU	5	JM2PB	93
ACJS-MC	104	ACPM-RB	99	AG4M	118	AX5MB	5	JM2PB-AU	93
ACJS - MH	104	ACPM-RB-AU	99	AG4MCC	118	AX5MB-AU	5	JM2PB BULK	93
ACJS-MHD	105	ACPM-RB BULK	99	AG4MCCH	118	AX5MB BULK	5	JM2P BULK	93
ACJS-MHD985	102	ACPM-RN	99	AG4MPCH	119	AX5M BULK	5	JS3P	93
ACJS-MHDC*	104	ACPM-RN-AU	99	AG5F	118	AX-BOOT	133	JS3P-AU	93
ACJS-MHDCM	104	ACPM-RN BULK	99	AG5FCCH	118	AX-BOOT-1	133	JS3PB	93
ACJS-MHDE	105	ACPM-TB	97	AG5FCE	118	AX-BOOT-2	133	JS3PB-AU	93
ACJS-MHDEM	105	ACPM-TB-AU	97	AG5FCRV	119	AX-BOOT-3	133	JS3P BULK	93
ACJS-MHDM	105	ACPM-TB BULK	97	AG5FL	118	AX-BOOT-4	133		
ACJS-MHDR	103	ACPM-TN	97	AG5M	118	AX-BOOT-5	133	K	
ACJS-MHDRM	103	ACPM-TN-AU	97	AG5MCC	118	AX-BOOT-6	133		
ACJS-MHOM	103	ACPM-TN BULK	97	AG5MCCH	118	AX-BOOT-7	133	KM2P	112

KM2P-AU	112	MP-4164-54S-C	124	RJX8FB5HRGB	73	SP-2-FBSL	53	TM2PJ	89
KM2PB	112	MP-4164-85S	124	RJX8FB5HRGEB	74	SP-2-FG	53	TM2PN	90
KM2PB-AU	112	MP-4164-85S-C	124	RJX8FB5HRRB	73	SP-2-FL	53	TM2PN-AU	90
KM2PB BULK	112	MP-4164-150S	124	RJX8FB5HRREB	74	SP-2-FN	53	TM2PN BULK	90
KM2P BULK	112	MP-4164-150S-C	124	RJX8FB5HRYB	73	SP-2-FNG	53	TM2PNJ	90
KS3P	112	MP-6211-39S	128	RJX8FB5HRYEB	74	SP-2-FNL	53	TM2R	90
KS3P-AU	112	MP-6211-39S-C	128	RJX8FB5HUUB	73	SP-2-FNS	53	TM2RB	90
KS3PB	112	MP-6211-61S	128	RJX8FB5HUUEB	74	SP-2-FNSG	53	TM2RBJ	90
KS3PB-AU	112	MP-6211-61S-C	128	RJX8FB5VB	74	SP-2-FNSL	53	TM2RBJ-AU	90
KS3PB BULK	112	MP-6216-39P	128	RJX8FB5VEB	74	SP-2-FS	53	TM2RBJ BULK	90
KS3P BULK	112	MP-6216-39P-C	128	RJX8FB5VGRB	74	SP-2-FSG	53	TM2RJ	90
KS3PC	112	MP-6216-61P	128	RJX8FB5VGREB	75	SP-2-FSL	53	TM2RJ-AU	90
KS3PC-AU	112	MP-6216-61P-C	128	RJX8FB5VGYB	74	SP-2-MD	55	TM2RJ BULK	90
		MP-6511-39S	128	RJX8FB5VGYEB	75	SP-2-MDH	55	TS3P	89
M		MP-6511-39S-C	128	RJX8FB5VRGB	74	SP-2-MDV	55	TS3P-AU	89
		MP-6511-61S	128	RJX8FB5VRGEB	75	SP-4-F	54	TS3PB	89
M22520/1-01	126	MP-6511-61S-C	128	RJX8FB5VRRB	74	SP4F4FDW	133	TS3PB-AU	89
MP-738-39L	129	MP-6516-39P	128	RJX8FB5VRREB	75	SP-4-FB	54	TS3PB BULK	89
MP-738-39S	129	MP-6516-39P-C	128	RJX8FB5VRYB	74	SP-4-FBG	54	TS3PBJ	89
MP-738-61L	129	MP-6516-61P	128	RJX8FB5VRYEB	75	SP-4-FBL	54	TS3PBM	90
MP-738-61S	129	MP-6516-61P-C	128	RJX8FB5VUUB	74	SP-4-FBS	54	TS3PBM-AU	90
MP-742-39L	129	MP-25042-13L	124	RJX8FB5VUUEB	75	SP-4-FBSG	54	TS3PBM BULK	90
MP-742-39S	129	MP-25042-13S	124	RJX8FB6HB	73	SP-4-FBSL	54	TS3PBMJ	90
MP-742-61L	129	MP-25042-19L	124	RJX8FB6HEB	73	SP-4-FG	54	TS3P BULK	89
MP-742-61S	129	MP-25042-19S	124	RJX8FB6HGRB	73	SP-4-FL	54	TS3PJ	89
MP-4101-13P	123	MP-25042-25L	124	RJX8FB6HGREB	74	SP-4-FN	54	TS3PN	90
MP-4101-13P-C	123	MP-25042-25S	124	RJX8FB6HGYB	73	SP-4-FNG	54	TS3PN-AU	90
MP-4101-19P	123	MP-25042-37L	124	RJX8FB6HGYEB	74	SP-4-FNL	54	TS3PN BULK	90
MP-4101-19P-C	123	MP-25042-37S	124	RJX8FB6HRGB	73	SP-4-FNS	54	TS3PNJ	90
MP-4101-25P	123	MP-25042-54L	124	RJX8FB6HRGEB	74	SP-4-FNSG	54	TS3R	90
MP-4101-25P-C	123	MP-25042-54S	124	RJX8FB6HRRB	73	SP-4-FNSL	54	TS3RB	90
MP-4101-37P	123	MP-25042-85L	124	RJX8FB6HRRREB	74	SP-4-FS	54	TS3RBJ	90
MP-4101-37P-C	123	MP-25042-85S	124	RJX8FB6HRYB	73	SP-4-FSG	54	TS3RBJ-AU	90
MP-4101-54P	123	MP-25042-150L	124	RJX8FB6HRYEB	74	SP-4-FSL	54	TS3RBJ BULK	90
MP-4101-54P-C	123	MP-25042-150S	124	RJX8FB6HUUB	73	SP-4-MC	56	TS3RJ	90
MP-4101-85P	123	MP-25043-13L	125	RJX8FB6HUUEB	74	SP-4-MD	55	TS3RJ-AU	90
MP-4101-85P-C	123	MP-25043-13S	125	RJX8FB6VB	74	SP-4-MD-8	55	TS3RJ BULK	90
MP-4101-150P	123	MP-25043-19L	125	RJX8FB6VEB	74	SP-4-MDH	55		
MP-4101-150P-C	123	MP-25043-19S	125	RJX8FB6VGRB	74	SP-4-MDHT	56		
MP-4102-13P	124	MP-25043-25L	125	RJX8FB6VGREB	75	SP-4-MDHT-8	55		
MP-4102-13P-C	124	MP-25043-25S	125	RJX8FB6VGYB	75	SP-4-MDT	55		
MP-4102-19P	124	MP-25043-37L	125	RJX8FB6VGYEB	75	SP-4-MDV	56		
MP-4102-19P-C	124	MP-25043-37S	125	RJX8FB6VRGB	74	SP-4-MDV-2	56		
MP-4102-25P	124	MP-25043-54L	125	RJX8FB6VRGEB	75	SP-4-MDVT-8	56		
MP-4102-25P-C	124	MP-25043-54S	125	RJX8FB6VRRB	74				
MP-4102-37P	124	MP-25043-85L	125	RJX8FB6VRREB	75	T			
MP-4102-37P-C	124	MP-25043-85S	125	RJX8FB6VRYB	74				
MP-4102-54P	124	MP-25043-150L	125	RJX8FB6VRYEB	75	T2860	133		
MP-4102-54P-C	124	MP-25043-150S	125	RJX8FB6VUUB	74	T2880	133		
MP-4102-85P	124	MP-108300	126	RJX8FB6VUUEB	75	T2890	133		
MP-4102-85P-C	124	MP-108400	126	RJX8FD3HB	77	TH29-1	126		
MP-4106-13S	123	MP-108500	126	RJX8FD3VB	77	TM1P	91		
MP-4106-13S-C	123	MP-108600	126	RJX8FD5HB	77	TM1P-AU	91		
MP-4106-19S	123	MP-EXT-16/18	126	RJX8FD5I	77	TM1PB	91		
MP-4106-19S-C	123	MP-GUIDE-16	126	RJX8FD5T	77	TM1PB-AU	91		
MP-4106-25S	123	MP-GUIDE-18	126	RJX8FD5VB	77	TM1PB BULK	91		
MP-4106-25S-C	123	MP-INS-16	126	RJX8FD6HB	77	TM1PBJ	91		
MP-4106-37S	123	MP-INS-18	126	RJX8FD6I	77	TM1P BULK	91		
MP-4106-37S-C	123	R		RJX8FD6T	77	TM1PJ	91		
MP-4106-54S	123			RJX8FD6VB	77	TM1RBJ	91		
MP-4106-54S-C	123			RJX8FD6VB	77	TM1RBJ-AU	91		
MP-4106-85S	123	RJX8FA3HB	73	RJX8FD5110	77	TM1RBJ BULK	91		
MP-4106-85S-C	123	RJX8FA3VB	74	RJX8FD6110	77	TM1RBJ BULK	91		
MP-4106-85S-C	123	RJX8FA5VB	74	RJX8M	70	TM1RJ	91		
MP-4106-150S	123	RJX8FA6HB	73	RJX8MB	70	TM1RJ-AU	91		
MP-4106-150S-C	123	RJX8FA6VB	74	RJX8MB BULK	70	TM1RJ BULK	91		
MP-4164-13S	124	RJX8FB3HB	73	RJX8M BULK	70	TM2P	89		
MP-4164-13S-C	124	RJX8FB3HEB	73	S		TM2P-AU	89		
MP-4164-19S	124	RJX8FB3VB	74	SP-2-F	53	TM2PB	89		
MP-4164-19S-C	124	RJX8FB3VEB	74	SP2F2FDW	133	TM2PB-AU	89		
MP-4164-25S	124	RJX8FB5HB	73	SP-2-FB	53	TM2PB BULK	89		
MP-4164-25S-C	124	RJX8FB5HGRB	73	SP-2-FBG	53	TM2PBJ	89		
MP-4164-37S	124	RJX8FB5HEB	73	SP-2-FB	53	TM2PBM	90		
MP-4164-37S-C	124	RJX8FB5HGREB	74	SP-2-FBL	53	TM2PBM-AU	90		
MP-4164-54S	124	RJX8FB5HGYB	73	SP-2-FBS	53	TM2PBM BULK	90		
		RJX8FB5HGYEB	74	SP-2-FBSL	53	TM2PBMJ	90		
						TM2P BULK	89		

PRODUCT SAFETY INFORMATION

This should be read in conjunction with Data Sheet information contained in individual product brochures. Failure to observe the advice in this information sheet and the operating conditions specified in the Data Sheets could result in hazardous situations.

1. Material Content and Physical Form

Electrical connectors do not usually contain hazardous materials. They contain conducting and non-conducting materials. Shells are manufactured in metal and plastic. Insulators can be formed in either natural rubber, synthetic rubber, plastic or glass insulating materials. Contact materials vary with the type of connector and its application. They are usually manufactured from either copper alloys, nickel, alumel, chromel or steel. In special applications, other alloys may be specified.

2. Fire Characteristics and Electric Shock Hazard

There is no fire hazard when the connector is correctly wired and used within the specified parameters. Incorrect wiring or assembly of the connector or careless use of metal tools or conductive fluids, or transit damage to any of the component parts may cause electric shock or burns. Live circuits must not be broken by separating mated connectors as this may cause arcing, ionisation and burning. Heat dissipation is greater at maximum resistance in a circuit. Hot spots may occur when resistance is raised locally by damage, e.g. cracked or deformed contacts, or broken strands of wire. Local overheating may also result from the use of the incorrect application tools or from poor quality soldering.

Overheating may occur if the ratings in the Data Sheets are exceeded and can cause breakdown of insulation and hence electric shock.

If heating is allowed to continue it intensifies by further increasing the local resistance through loss of temper or spring contact, formation of oxide film on contacts and wires, and leakage currents through carbonisation of insulation and tracking points. Fire can then result in the presence of combustible materials and this may release noxious fumes. Overheating may not be visually apparent. Burns may result from touching overheated components.

3. Handling

Care must be taken to avoid damage to any component parts of electrical connectors during installation and use. Although there are normally no sharp edges, care must be taken when handling certain components to avoid injury to fingers. Electrical connectors may be damaged in transit to customers, and damage may result in creation of hazards. Products should therefore be examined prior to installation/use and rejected if found to be damaged.

4. Disposal

Incineration of certain materials may release noxious or even toxic fumes.

5. Application

Connectors with exposed contacts should not be selected for use on the current supply side of an electrical circuit, because an electric shock could result from touching exposed contacts of an unmated connector. Voltages in excess of 30 V.A.C. or 42.5

V.D.C. are potentially hazardous and care should be taken to ensure that such voltages cannot be transmitted in any way to exposed metal parts of the connector body. The connector and wiring should be checked, before making live, to have no damage to metal parts or insulators, no solder blobs, loose strands, conducting lubricants, swarf, or any other undesired conducting particles. Circuit resistance and continuity check should be made to make certain that there are no low resistance joints or spurious conducting paths. Always use the correct application tools as specified in the Data Sheets. Do not permit untrained personnel to wire, assemble or tamper with connectors. For operation voltage please see appropriate national regulations.

Important General Information

A) Air and creepage paths / Operating voltage.

The admissible operating voltages depend on the individual applications and the valid national and other applicable safety regulations. For this reason the air and creepage path data are only reference values. Observe reduction of air and creepage paths due to PC board and/or harnessing.

B) Other important information

Amphenol Australia Pty Ltd continuously endeavours to improve its products. Therefore, products may deviate from the description, technical data and shape as shown in product brochures.

C) Assembly instructions

If applicable, special assembly instructions have been included in or on the connector packaging. See also separate instructions in product brochures.

DISTRIBUTED BY

Amphenol Australia Pty Ltd

22 Industry Blvd.
Carrum Downs VIC 3201
Australia

Phone: +61 3 8796 8888
Fax: +61 3 8796 8801
E-mail: info@amphenol.com.au
Web: www.amphenolaudio.com

Amphenol Audio USA

Sales Office

P.O. Box 11401
Denver CO 80211 USA

Phone: +1 720 508 3443
Email: sales@amphenolaudio.com

Warehouse

5069 Maureen Lane, Unit B
Moorpark CA 93021 USA

© 2015 Amphenol Australia Pty Ltd

Subject to all applicable laws and regulations Amphenol Australia Pty Ltd reserves the right to change specifications of any product, system or service contained in this brochure without liability.

Catalogue Part Number: CAT-AUDIO-01