

SinglFuse™ SF-2410SPxxxW Series Features

- Single blow fuse for overcurrent protection
- 6125 (EIA 2410) footprint
- Time lag fuse
- UL 248-14 listed
- RoHS compliant* and halogen free**
- Wire core SMD design
- Surface mount packaging for automated assembly
- High AC power one-time protection fuse

SF-2410SPxxxW Series - Time Lag Wire Core Surface Mount Fuses

Electrical Characteristics

Model	Rated Current (Amps)	Fusing Time	Resistance (Ω) Typ.***	Rated Voltage	Interrupting Rating	Voltage Drop Max. (mV)	Typical I ² t (A ² s)****
SF-2410SP050W-2	0.50	Open within 120 sec. at 200 % rated current	0.206	AC 250 V	AC 250 V 100 A DC 125 V 50 A	166	0.11
SF-2410SP063W-2	0.63		0.148			144	0.20
SF-2410SP080W-2	0.80		0.109			139	0.35
SF-2410SP100W-2	1.00		0.084			129	0.62
SF-2410SP125W-2	1.25		0.065			128	1.00
SF-2410SP160W-2	1.60		0.049			127	1.80
SF-2410SP200W-2	2.00		0.038			123	3.00

*** Resistance value measured with ≤10 % rated current at 25 °C ambient.

**** Melting I²t calculated at 0.001 second pre-arcing time.

Reliability Testing

No.	Test	Requirement	Test Condition	Test Reference
1	Reflow and bend	DCR change ≤ 20 % (≤ 10 % for ≤1 A) No mechanical damage	3 reflows at 245 °C followed by a 2 mm bend	Refer to STP document
2	Solderability	Minimum 90 % coverage	One dip at 245 °C for 5 seconds	MIL-STD-202 Method 208
3	Soldering heat resistance	DCR change ≤ 20 % (≤ 10 % for ≤1 A) New solder coverage ≤ 75 %	One dip at 260 °C for 10 seconds	MIL-STD-202 Method 210
4	Moisture resistance	DCR change ≤ ±15 % No excessive corrosion	10 cycles	MIL-STD-202 Method 106
5	Salt spray	DCR change ≤ ±10 % No excessive corrosion	48 hour exposure, 5 % salt solution	MIL-STD-202 Method 101
6	Mechanical vibration	DCR change ≤ ±10 % No mechanical damage	0.4 inch D.A. or 30 G between 5-3000 Hz	MIL-STD-202 Method 204
7	Mechanical shock	DCR change ≤ ±10 % No mechanical damage	1500 G, 0.5 ms, half-sine shocks	MIL-STD-202 Method 213
8	Thermal Shock	DCR change ≤ ±10 % No mechanical damage	100 cycles between -65 °C and +125 °C	MIL-STD-202 Method 107
9	Life	No electrical "opens" during testing Voltage drop change shall be less than ±20 % of initial value	80 % rated current (75 % for < 1 A fuses) for 2000 hours at ambient temperature +25 °C	Refer to STP document

Agency Recognition

UL File Number E198545

<http://www.ul.com/> Follow link to Online Certificates Directory, then enter UL File No. E198545, or [click here](#)

BOURNS®

Asia-Pacific: Tel: +886-2 2562-4117 • Email: asiacus@bourns.com

EMEA: Tel: +36 88 520 390 • Email: eurocus@bourns.com

The Americas: Tel: +1-951 781-5500 • Email: americus@bourns.com

www.bourns.com

* RoHS Directive 2002/95/EC Jan. 27, 2003 including annex and RoHS Recast 2011/65/EU June 8, 2011.

** Bourns considers a product to be "halogen free" if (a) the Bromine (Br) content is 900 ppm or less; (b) the Chlorine (Cl) content is 900 ppm or less; and (c) the total Bromine (Br) and Chlorine (Cl) content is 1500 ppm or less.

"SinglFuse" is a trademark of Bourns, Inc.

Specifications are subject to change without notice.

The device characteristics and parameters in this data sheet can and do vary in different applications and actual device performance may vary over time.

Users should verify actual device performance in their specific applications.

SingIFuse™ SF-2410SPxxxW Series Applications

- White goods
- Lighting ballasts
- LED drivers
- Medical equipment (excluding critical life support)
- DC/DC converters
- Power chargers
- Power adapters
- Industrial equipment

SF-2410SPxxxW Series - Time Lag Wire Core Surface Mount Fuses BOURNS®

Environmental Characteristics

Operating Temperature.....	-55 °C to +125 °C
Storage Conditions	
Temperature	+5 °C to +35 °C
Humidity.....	40 % to 75 %
Shelf Life.....	2 years from manufacturing date
Moisture Sensitivity Level.....	1
ESD Classification (HBM).....	Class 6

Typical Part Marking

Represents total content. Layout may vary.



RATED CURRENT (A)	
C = 0.50	F = 1.25
S = 0.63	T = 1.60
H = 0.80	I = 2.00
E = 1.00	

How to Order

SF - 2410 SP 100 W - 2

SingIFuse™
 Product Designator
 SMD Footprint
 2410 = 6125 (EIA 2410) size
 Fuse Blow Type
 SP = Time Lag
 Rated Current
 050 ~ 200 (0.5 A ~ 2.0 A)
 Structure Type
 W = Wire Core
 Packaging Type
 - 2 = Tape & Reel

Construction

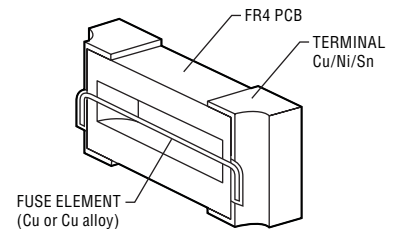

Packaging Quantity

2,000 pieces per 7-inch reel

Product Dimensions

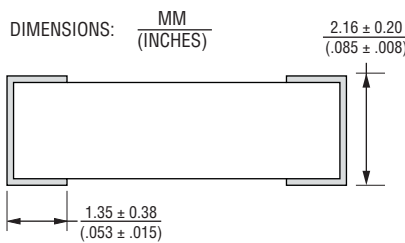
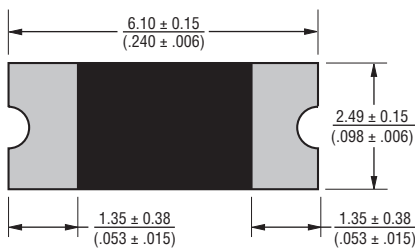

Recommended Pad Layout

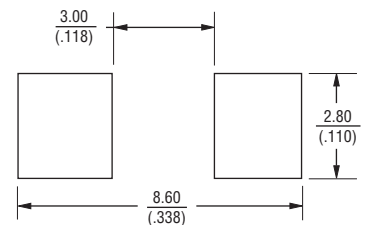

Current Rating Thermal Derating Curve

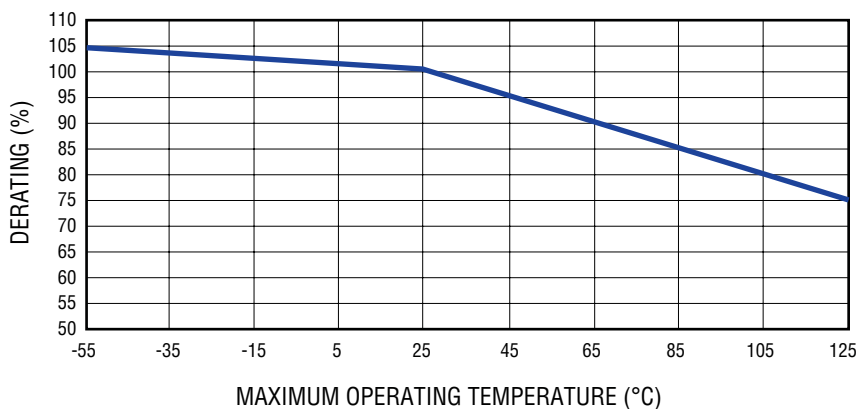

Specifications are subject to change without notice. The device characteristics and parameters in this data sheet can and do vary in different applications and actual device performance may vary over time. Users should verify actual device performance in their specific applications.

Solder Reflow Recommendations



Profile Feature	Pb-Free Assembly
Preheat / Soak: Temperature Min. (T_{smin}) Temperature Max. (T_{smax}) Time (t_s) from (T_{smin} to T_{smax})	150 °C 200 °C 60~120 seconds
Ramp Up Rate (T_l to T_d)	3 °C / second max.
Liquidous Temperature (T_l) Time (t_L) maintained above T_l	217 °C 60~150 seconds
Peak Package Body Temperature (T_d)	260 °C
Time (t_p)* within 5 °C of the specified classification temperature (T_c)	30 seconds*
Ramp Down Rate (T_d to T_l)	6 °C / second max.
Time 25 °C to Peak Temperature	8 minutes max.

* Tolerance for peak profile temperature (T_p) is defined as a supplier minimum and a user maximum.

Recommended Temperature Profile for Wave Soldering



Wave soldering is suitable for 2410 size models.

Average Pre-Arcing Time vs. Current Curves

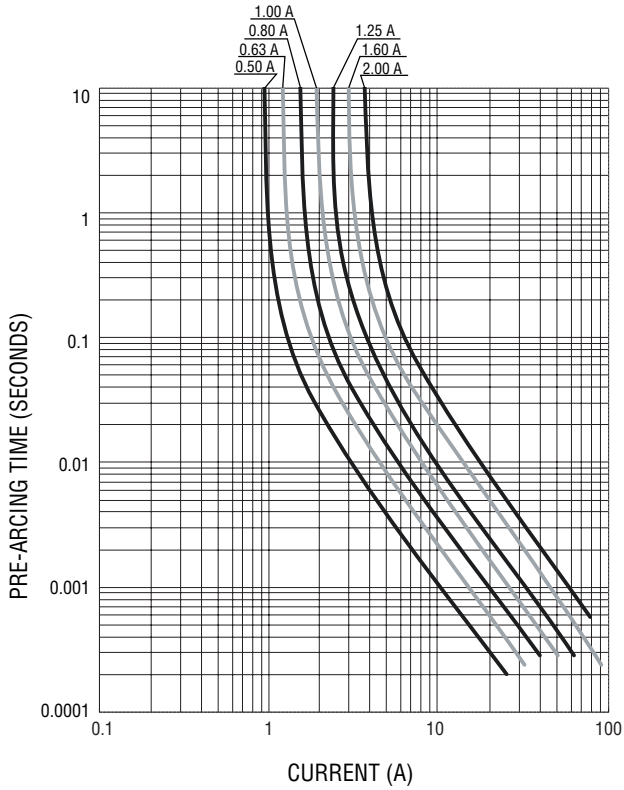

Average I²t vs. t Curves

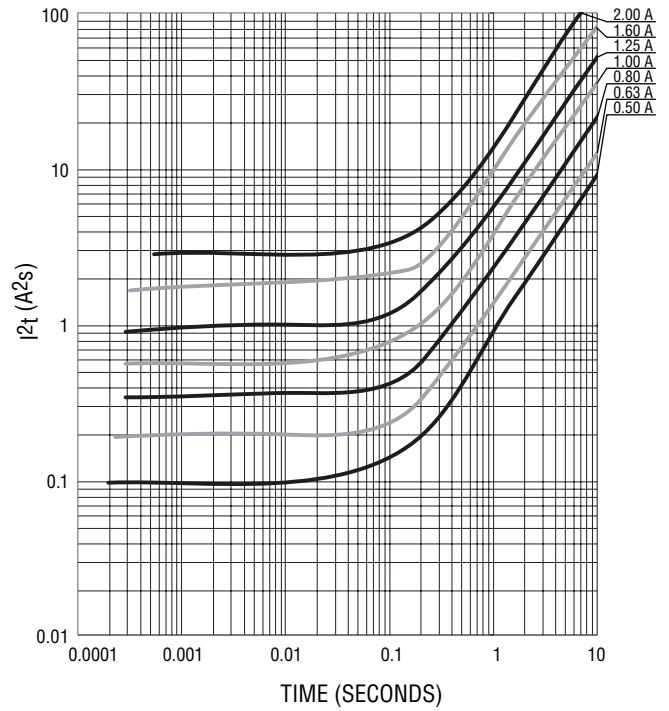

SF-2410SPxxxW Series Tape and Reel Packaging Specifications



SF-2410SPxxxW Series per EIA 481-2

Tape Dimensions

W	$\frac{12.00 \pm 0.10}{(.48 \pm .004)}$
P ₀	$\frac{4.0 \pm 0.10}{(.157 \pm .004)}$
P ₁	$\frac{4.0 \pm 0.10}{(.157 \pm .004)}$
P ₂	$\frac{2.0 \pm 0.05}{(.079 \pm .002)}$
A ₀	$\frac{2.85 \pm 0.10}{(.114 \pm .004)}$
B ₀	$\frac{6.40 \pm 0.10}{(.256 \pm .004)}$
F	$\frac{5.50 \pm 0.10}{(.220 \pm .004)}$
E	$\frac{1.75 \pm 0.10}{(.069 \pm .004)}$
D ₀	$\frac{1.55 \pm 0.10}{(.059 \pm .004)}$
D ₁	$\frac{1.55 \pm 0.10}{(.059 \pm .004)}$
K ₀	$\frac{2.35 \pm 0.10}{(.094 \pm .004)}$
T	$\frac{0.25 \pm 0.05}{(.010 \pm .002)}$

PACKAGING: Plastic tape, 2,000 pcs. per reel

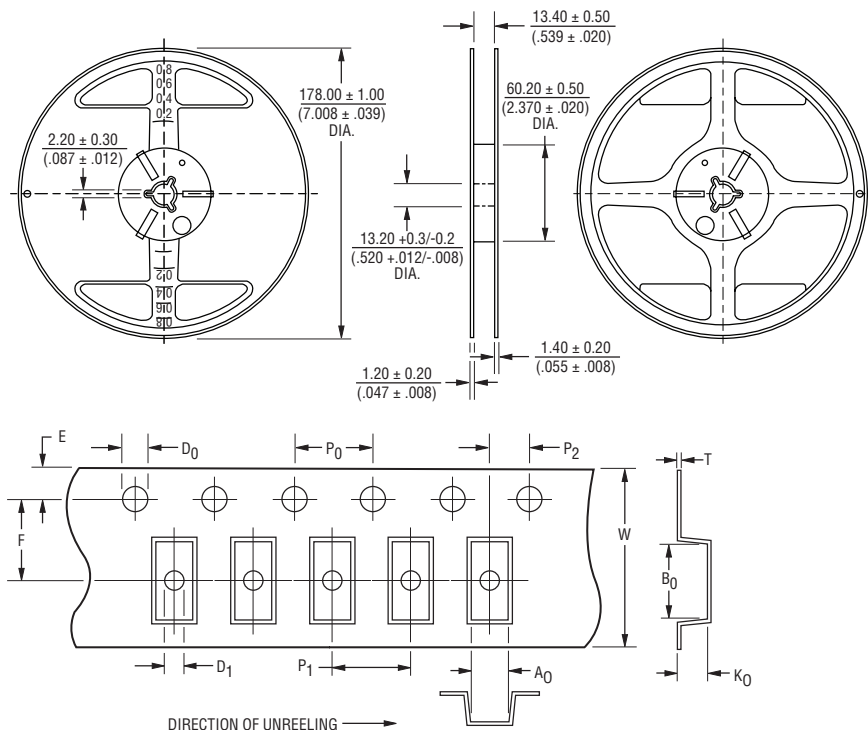

DIMENSIONS: $\frac{\text{MM}}{(\text{INCHES})}$

Specifications are subject to change without notice.

The device characteristics and parameters in this data sheet can and do vary in different applications and actual device performance may vary over time. Users should verify actual device performance in their specific applications.