



TruStability[®] Board Mount Pressure Sensors

TSC Series, Compensated/Unamplified

± 60 mbar to ± 10 bar | ± 6 kPa to ± 1 MPa | ± 1 psi to ± 150 psi
Millivolt Analog Output

NSC Series, Uncompensated/Unamplified

± 2.5 mbar to ± 10 bar | ± 250 Pa to ± 1 MPa | ± 1 inH₂O to ± 150 psi
Millivolt Analog Output



TruStability® Board Mount Pressure Sensors

Honeywell's TruStability® TSC Series and NSC Series are piezoresistive silicon pressure sensors offering a ratiometric analog output for reading pressure over the specified full scale pressure span and temperature range.

TSC Series:

- Temperature compensated and unamplified.
- Compensation makes it easier to integrate the sensor into a system by eliminating the need to calibrate the system over temperature and also offers reduced part-to-part variation.
- Compensated temperature range is 0 °C to 85 °C [-32 °F to 185 °F].
- Operating temperature range is -40 °C to 85 °C [-40 °F to 185 °F].
- Measures differential or gage pressures

NSC Series:

- Uncompensated and unamplified.
- Allows customers the flexibility of performing their own calibration while still benefiting from the industry-leading stability, accuracy, and repeatability that the Honeywell TruStability® Pressure Sensors provide.
- Operates as specified from -40 °C to 85 °C [-40 °F to 185 °F].
- Measures absolute, differential or gage pressures.

The absolute versions have an internal vacuum reference and an output value proportional to absolute pressure. Differential versions allow measurement of pressure between two pressure ports. Gage versions are referenced to atmospheric pressure and provide an output proportional to pressure variations from atmosphere.

The TSC Series and NSC Series sensors are intended for use with non-corrosive, non-ionic gases, such as air. Port 1 can also be used for non-corrosive, non-ionic liquids on sensors rated above 60 mbar | 6 kPa | 1 psi.

The TSC and NSC Series offer numerous package styles and mounting options, making it easier for device manufacturers to integrate the product into their applications. These sensors offer infinite resolution on the pressure signal. Frequency response is also typically limited only by the end user's system. All products are designed and manufactured according to ISO 9001.

Table of Contents

Features and Benefits	3-4
Potential Applications	5
TSC Series and NSC Series General Specifications	6-7
TSC Series Nomenclature and Order Guide	8
NSC Series Nomenclature and Order Guide	9
TSC Series Pressure Range Specifications	
±60 mbar to ±10 bar	10
±6 kPa to ±1 MPa	11
±1 psi to ±150 psi	12
NSC Series Pressure Range Specifications	
±2.5 mbar to ±10 bar	13
±250 Pa to ±1 MPa	14
±1 inH ₂ O to ±150 psi	15
Available Standard Configurations	16-17
Dimensional Drawings	
DIP Packages	18-20
SMT Packages	21-23
SIP Packages	24-28
Pinouts, PCB Layouts, Circuit Examples	29
TruStability® Board Mount Pressure Sensors Portfolio Overview	30
Additional Information	back cover

What makes our sensors better?

- Stability and reliability you can count on
- Industry-leading accuracy down to ±0.15 %FSS BFSL
- Port and housing options simplify integration
- Wide pressure range from ±2.5 mbar to ±10 bar | ±250 Pa to ±1 MPa | ±1 inH₂O to ±150 psi
- Small package size
- Low power consumption

STABILITY • ACCURACY • FLEXIBILITY • SMALL SIZE

Features and Benefits

INDUSTRY-LEADING LONG-TERM STABILITY

Even after long-term use and thermal extremes, these sensors perform substantially better relative to stability than any other pressure sensor available in the industry today:

- Minimizes system calibration needs and maximizes system performance.
- Helps support system uptime by eliminating the need to service or replace the sensor during its application life.

INDUSTRY-LEADING ACCURACY

Extremely tight accuracy down to ± 0.15 %FSS BFSL:

- Reduces software needed to correct system inaccuracies, minimizing system design time.
- Supports system accuracy and warranty requirements.

Minimizes system calibration and design needs; supports system uptime.

INDUSTRY-LEADING FLEXIBILITY

- Modular, flexible design with numerous package styles, pressure ports, and options simplifies integration into the device manufacturer's application.
- Single side wet media allows the end customer to use one port of the sensor with condensing humidity or directly with non-corrosive liquid media.

Simplifies product integration.

INSENSITIVE TO MOUNTING ORIENTATION

Allows flexibility of use within the application.

SMALL SIZE

Miniature 10 mm x 10 mm [0.39 in x 0.39 in] package is very small when compared to most board mount pressure sensors:

- Occupies less area on the PCB.
- Typically allows for easy placement on crowded PCBs or in small devices.

REPEATABILITY

Provides **excellent repeatability, high accuracy and reliability** under many demanding conditions.

SUPPORTS LEAN MANUFACTURING

- J-STD-020-D MSL 1 unlimited shelf life after packaging is opened.
- System can be calibrated within one hour after reflow solder.
- Compatible with modern lead-free and no-clean solder processes.

Features and Benefits

EXTREMELY LOW POWER CONSUMPTION

- Operating supply voltage as low as 1.5 Vdc.
- Reduces power consumption, provides extended battery life, and promotes energy efficiency.

ABSOLUTE, DIFFERENTIAL AND GAGE TYPES

- Provides flexibility of use within the application.
- Absolute type on NSC Series only.

PRESSURE RANGES FROM ± 2.5 MBAR TO ± 10 BAR | ± 250 PA TO ± 1 MPA | ± 1 INH₂O TO ± 150 PSI

Optimizes the customer's system performance by maximizing pressure resolution with more available pressure ranges.

ROHS AND ISO9001 COMPLIANCE

Potential Applications



MEDICAL

- NEBULIZERS
- SPIROMETERS
- PATIENT MONITORING EQUIPMENT
- THERAPEUTIC HOSPITAL BEDS
- HOSPITAL GAS SUPPLY
- OXYGEN CONCENTRATORS
- BLOOD ANALYSIS
- GAS CHROMATOGRAPHY
- ANALYTICAL INSTRUMENTS

INDUSTRIAL

- VALVES
- PUMPS
- ACTUATORS
- HVAC TRANSMITTERS
- AUTOMATED PNEUMATIC ASSEMBLY EQUIPMENT
- PNEUMATIC OPERATOR CONTROL SYSTEMS
- INDUSTRIAL GAS SUPPLY
- BAROMETRY
- GAS CHROMATOGRAPHY
- ANALYTICAL INSTRUMENT SAMPLING SYSTEMS

TSC Series and NSC Series General Specifications

Table 1. Absolute Maximum Ratings¹

Characteristic	Min.	Max.	Unit
Supply voltage (V_{supply}) ² : pressure ranges ≥ 60 mbar 6 kPa 1 psi pressure ranges ≤ 40 mbar 4 kPa 20 inH ₂ O	-12.0 0	12.0 7	Vdc
Storage temperature	-40 [-40]	85 [185]	°C [°F]
Soldering time and temperature: lead solder temperature (SIP, DIP) peak reflow temperature (SMT)		4 s max. at 250 °C [482 °F] 15 s max. at 250 °C [482 °F]	

¹Absolute maximum ratings are the extreme limits the device will withstand without damage.

²Incorrect application of supply voltage or ground to the wrong pin may cause electrical failure.

Table 2. Operating Specifications

Characteristic	Min.	Typ.	Max.	Unit
Supply voltage (V_{supply}) ^{1,2} : pressure ranges ≥ 60 mbar 6 kPa 1 psi pressure ranges ≤ 40 mbar 4 kPa 20 H ₂ O	1.5 2.7	5.0 5.0	12.0 6.5	Vdc
Supply current (at 5.0 Vdc supply) TSC Series NSC Series	— —	0.6 1.5	1 2.2	mA
Operating temperature range ³	-40 [-40]	—	85 [185]	°C [°F]
TSC Series compensated temperature range ⁴	0 [32]	—	85 [185]	°C [°F]
Startup time	—	—	5	ms
TSC Series output resistance	—	2.5	—	kOhm

¹Ratiometricity of the sensor (the ability of the device output to scale to the supply voltage) is achieved within the specified operating voltage.

²Incorrect application of supply voltage or ground to the wrong pin may cause electrical failure.

³Operating temperature range: The temperature range over which the sensor will produce an output proportional to pressure.

⁴Compensated temperature range: The temperature range over which the sensor will produce an output proportional to pressure within the specified performance limits.

Table 3. Environmental Specifications

Characteristic	Parameter
Humidity	0% to 95% RH, non-condensing
Vibration	MIL-STD-202G, Method 204D, Condition B (15 g, 10 Hz to 2 kHz)
Shock	MIL-STD-202G, Method 213B, Condition C (100 g, 6 ms duration)
Life ¹	1 million pressure cycles minimum
Solder reflow	J-STD-020-D MSL1 (unlimited shelf life when stored at less than 30 °C and 85 %RH)

¹Life may vary depending on the specific application in which the sensor is utilized.

TSC Series and NSC Series General Specifications

Table 4. Wetted Materials¹

Component	Port 1 (Pressure Port)	Port 2 (Reference Port)
Ports and covers	high temperature polyamide	high temperature polyamide
Substrate	alumina ceramic	alumina ceramic
Adhesives	epoxy, RTV	epoxy, RTV
Electronic components	silicon	silicon, glass, gold

¹Contact Honeywell Customer Service for detailed material information.

CAUTION

PRODUCT DAMAGE

- Ensure liquid media is applied to Port 1 only; Port 2 is not compatible with liquids.
- Ensure liquid media contains no particulates. All TruStability® sensors are dead-ended devices. Particulates can accumulate inside the sensor, causing damage or affecting sensor output.
- Recommend that the sensor be positioned with Port 1 facing downwards; any particulates in the system are less likely to enter and settle within the pressure sensor if it is in this position.
- Ensure liquid media does not create a residue when dried; build-up inside the sensor may affect sensor output. Rinsing of a dead-ended sensor is difficult and has limited effectiveness for removing residue.
- Ensure liquid media are compatible with wetted materials. Non-compatible liquid media will degrade sensor performance and may lead to sensor failure.

Failure to comply with these instructions may result in product damage.

Table 5. Sensor Pressure Types

Pressure Type	Description
Absolute	Output is proportional to the difference between applied pressure and a built-in reference to vacuum.
Differential	Output is proportional to the difference between the pressures applied to each port (Port 1 – Port 2).
Gage	Output is proportional to the difference between applied pressure and atmospheric (ambient) pressure.

TSC Series Nomenclature and Order Guide

Figure 1. TSC Series Nomenclature and Order Guide¹

































For example, **TSCDNNN150PGUCV** defines a TSC Series TruStability® Pressure Sensor, DIP package, NN pressure port, no special options, 150 psi gage pressure range, unamplified, compensated, constant supply voltage.

T S C D N N N 1 5 0 P G U C V

Series
TSC Compensated/Unamplified

Package
D DIP (Dual Inline Pin)
M SMT (Surface Mount Technology)
S SIP (Single Inline Pin)

Pressure Port

DIP	SMT	SIP
NN No ports 	NN No ports 	NN No ports 
—	—	AA Dual axial barbed ports, opposite sides 
AN Single axial barbed port 	AN Single axial barbed port 	AN Single axial barbed port 
LN Single axial barbless port 	LN Single axial barbless port 	LN Single axial barbless port 
—	—	FF Fastener mount, dual axial barbed ports, opposite sides 
—	—	FN Fastener mount, single axial barbed port 
—	—	GN Ribbed fastener mount, single axial barbed port 
—	—	NB Fastener mount, dual axial ports, same side 
RN Single radial barbed port 	RN Single radial barbed port 	RN Single radial barbed port 
RR Dual radial barbed ports, same side 	RR Dual radial barbed ports, same side 	RR Dual radial barbed ports, same side 
DR Dual radial barbed ports, opposite sides 	DR Dual radial barbed ports, opposite sides 	DR Dual radial barbed ports, opposite sides 
JN Single radial barbless port 	JN Single radial barbless port 	JN Single radial barbless port 
JJ Dual radial barbless ports, same side 	JJ Dual radial barbless ports, same side 	JJ Dual radial barbless ports, same side 
—	—	HH Fastener mount, dual radial barbed ports, same side 
—	—	HN Fastener mount, single radial barbed port 
—	—	MN Manifold mount, outer diameter seal 
—	—	SN Manifold mount, inner diameter seal 

Options
N No special options

Supply Voltage
V Constant

Compensation
C Compensated

Output Type
U Unamplified

Pressure Range

60 mbar to 10 bar <i>Differential</i>	6 kPa to 1 MPa <i>Differential</i>	1 psi to 150 psi <i>Differential</i>
060MD ±60 mbar	006KD ±6 kPa	001PD ±1 psi
100MD ±100 mbar	010KD ±10 kPa	005PD ±5 psi
160MD ±160 mbar	016KD ±16 kPa	015PD ±15 psi
250MD ±250 mbar	025KD ±25 kPa	030PD ±30 psi
400MD ±400 mbar	040KD ±40 kPa	060PD ±60 psi
600MD ±600 mbar	060KD ±60 kPa	100PD ±100 psi
001BD ±1 bar	100KD ±100 kPa	150PD ±150 psi
1.6BD ±1.6 bar	160KD ±160 kPa	
2.5BD ±2.5 bar	250KD ±250 kPa	
004BD ±4 bar	400KD ±400 kPa	
006BD ±6 bar	600KD ±600 kPa	
010BD ±10 bar	001GD ±1 MPa	

<i>Gage</i>	<i>Gage</i>	<i>Gage</i>
060MG 0 mbar to 60 mbar	006KG 0 kPa to 6 kPa	001PG 0 psi to 1 psi
100MG 0 mbar to 100 mbar	010KG 0 kPa to 10 kPa	005PG 0 psi to 5 psi
160MG 0 mbar to 160 mbar	016KG 0 kPa to 16 kPa	015PG 0 psi to 15 psi
250MG 0 mbar to 250 mbar	025KG 0 kPa to 25 kPa	030PG 0 psi to 30 psi
400MG 0 bar to 400 mbar	040KG 0 kPa to 40 kPa	060PG 0 psi to 60 psi
600MG 0 bar to 600 mbar	060KG 0 kPa to 60 kPa	100PG 0 psi to 100 psi
001BG 0 bar to 1 bar	100KG 0 kPa to 100 kPa	150PG 0 psi to 150 psi
1.6BG 0 bar to 1.6 bar	160KG 0 kPa to 160 kPa	
2.5BG 0 bar to 2.5 bar	250KG 0 kPa to 250 kPa	
004BG 0 bar to 4 bar	400KG 0 kPa to 400 kPa	
006BG 0 bar to 6 bar	600KG 0 kPa to 600 kPa	
010BG 0 bar to 10 bar	001GG 0 kPa to 1 MPa	

¹See Table 5 for an explanation of sensor pressure types.

NSC Series Nomenclature and Order Guide

Figure 2. NSC Series Nomenclature and Order Guide¹

For example, **NSCDNNN150PGUNV** defines an NSC Series TruStability® Pressure Sensor, DIP package, NN pressure port, no special options, 150 psi gage pressure range, unamplified, uncompensated, constant supply voltage.

N S C D N N N 1 5 0 P G U N V

Series
NSC Uncompensated/Unamplified

Package
D DIP (Dual Inline Pin)
M SMT (Surface Mount Technology)
S SIP (Single Inline Pin)

Pressure Port

DIP	SMT	SIP
NN No ports	NN No ports	NN No ports
AN Single axial barbed port	AN Single axial barbed port	AN Single axial barbed port
LN Single axial barbless port	LN Single axial barbless port	LN Single axial barbless port
—	—	FF Fastener mount, dual axial barbed ports, opposite sides
—	—	FN Fastener mount, single axial barbed port
—	—	GN Ribbed fastener mount, single axial barbed port
—	—	NB Fastener mount, dual axial ports, same side
RN Single radial barbed port	RN Single radial barbed port	RN Single radial barbed port
RR Dual radial barbed ports, same side	RR Dual radial barbed ports, same side	RR Dual radial barbed ports, same side
DR Dual radial barbed ports, opposite sides	DR Dual radial barbed ports, opposite sides	DR Dual radial barbed ports, opposite sides
JN Single radial barbless port	JN Single radial barbless port	JN Single radial barbless port
JJ Dual radial barbless ports, same side	JJ Dual radial barbless ports, same side	JJ Dual radial barbless ports, same side
—	—	HH Fastener mount, dual radial barbed ports, same side
—	—	HN Fastener mount, single radial barbed port
—	—	MN Manifold mount, outer diameter seal
—	—	SN Manifold mount, inner diameter seal

Options
N No special options

Supply Voltage
V Constant

Compensation
N Uncompensated

Output Type
U Unamplified

Pressure Range

2.5 mbar to 10 bar	400 Pa to 1 MPa	1 in H ₂ O to 150 psi
<i>Absolute</i>	<i>Absolute</i>	<i>Absolute</i>
001BA 0 bar to 1 bar	100KA 0 kPa to 100 kPa	015PA 0 psi to 15 psi
1.6BA 0 bar to 1.6 bar	160KA 0 kPa to 160 kPa	030PA 0 psi to 30 psi
2.5BA 0 bar to 2.5 bar	250KA 0 kPa to 250 kPa	060PA 0 psi to 60 psi
004BA 0 bar to 4 bar	400KA 0 kPa to 400 kPa	100PA 0 psi to 100 psi
006BA 0 bar to 6 bar	600KA 0 kPa to 600 kPa	150PA 0 psi to 150 psi
010BA 0 bar to 10 bar	001GA 0 kPa to 1 MPa	
<i>Differential</i>	<i>Differential</i>	<i>Differential</i>
2.5MD ±2.5 mbar	250LD ±250 Pa	001ND ±1 inH ₂ O
004MD ±4 mbar	400LD ±400 Pa	002ND ±2 inH ₂ O
006MD ±6 mbar	600LD ±600 Pa	004ND ±4 inH ₂ O
010MD ±10 mbar	001KD ±1 kPa	005ND ±5 inH ₂ O
016MD ±16 mbar	1.6KD ±1.6 kPa	010ND ±10 inH ₂ O
025MD ±25 mbar	2.5KD ±2.5 kPa	020ND ±20 inH ₂ O
040MD ±40 mbar	004KD ±4 kPa	030ND ±30 inH ₂ O
060MD ±60 mbar	006KD ±6 kPa	001PD ±1 psi
100MD ±100 mbar	010KD ±10 kPa	005PD ±5 psi
160MD ±160 mbar	016KD ±16 kPa	015PD ±15 psi
250MD ±250 mbar	025KD ±25 kPa	030PD ±30 psi
400MD ±400 mbar	040KD ±40 kPa	060PD ±60 psi
600MD ±600 mbar	060KD ±60 kPa	100PD ±100 psi
001BD ±1 bar	100KD ±100 kPa	150PD ±150 psi
1.6BD ±1.6 bar	160KD ±160 kPa	
2.5BD ±2.5 bar	250KD ±250 kPa	
004BD ±4 bar	400KD ±400 kPa	
006BD ±6 bar	600KD ±600 kPa	
010BD ±10 bar	001GD ±1 MPa	
<i>Gage</i>	<i>Gage</i>	<i>Gage</i>
004MG 0 mbar to 4 mbar	400LG 0 Pa to 400 Pa	002NG 0 inH ₂ O to 2 inH ₂ O
006MG 0 mbar to 6 mbar	600LG 0 Pa to 600 Pa	004NG 0 inH ₂ O to 4 inH ₂ O
010MG 0 mbar to 10 mbar	001KG 0 kPa to 1 kPa	005NG 0 inH ₂ O to 5 inH ₂ O
016MG 0 mbar to 16 mbar	1.6KG 0 kPa to 1.6 kPa	010NG 0 inH ₂ O to 10 inH ₂ O
025MG 0 mbar to 25 mbar	004KG 0 kPa to 4 kPa	020NG 0 inH ₂ O to 20 inH ₂ O
040MG 0 mbar to 40 mbar	006KG 0 kPa to 6 kPa	030NG 0 inH ₂ O to 30 inH ₂ O
060MG 0 mbar to 60 mbar	010KG 0 kPa to 10 kPa	001PG 0 psi to 1 psi
100MG 0 mbar to 100 mbar	016KG 0 kPa to 16 kPa	005PG 0 psi to 5 psi
160MG 0 mbar to 160 mbar	025KG 0 kPa to 25 kPa	015PG 0 psi to 15 psi
250MG 0 mbar to 250 mbar	040KG 0 kPa to 40 kPa	030PG 0 psi to 30 psi
400MG 0 bar to 400 mbar	060KG 0 kPa to 60 kPa	060PG 0 psi to 60 psi
600MG 0 bar to 600 mbar	100KG 0 kPa to 100 kPa	100PG 0 psi to 100 psi
001BG 0 bar to 1 bar	160KG 0 kPa to 160 kPa	150PG 0 psi to 150 psi
1.6BG 0 bar to 1.6 bar	250KG 0 kPa to 250 kPa	
2.5BG 0 bar to 2.5 bar	400KG 0 kPa to 400 kPa	
004BG 0 bar to 4 bar	600KG 0 kPa to 600 kPa	
006BG 0 bar to 6 bar	001GG 0 kPa to 1 MPa	
010BG 0 bar to 10 bar		

¹See Table 5 for an explanation of sensor pressure types.

TSC Series Specifications

±60 mbar to ±10 bar

Table 6. TSC Series Pressure Range Specifications for ±60 mbar to ±10 bar

Pressure Range Order Code (see Figure 1)	Pressure Range		Unit	Over Pressure	Burst Pressure	Common Mode Pressure	Pressure Accuracy (%FSS)	Offset ¹ (mV/V)	Full Scale Span (mV/V)			Thermal Effect on Offset ² (%FSS)		Thermal Effect on Span ³ (%FSS)		Long-Term Stability 1000 hr, 25 °C (%FSS)	Thermal Hysteresis ⁴ (%FSS)	
	Pmin.	Pmax.							Min.	Nom.	Max.	10 °C to 50 °C	0 °C to 85 °C	10 °C to 50 °C	0 °C to 85 °C			
Differential																		
060MD	-60	60	mbar	872	1370	10,000	±0.20	±0.075	2.46	2.60	2.80	±0.60	±1.15	±1.00	±2.00	±0.15	±0.15	
100MD	-100	100	mbar	872	1370	10,000	±0.20	±0.075	4.12	4.40	4.66	±0.35	±0.70	±1.00	±2.00	±0.10	±0.10	
160MD	-160	160	mbar	2000	4000	10,000	±0.15	±0.12	4.36	4.60	4.92	±0.80	±1.65	±0.75	±2.00	±0.10	±0.10	
250MD	-250	250	mbar	2000	4000	10,000	±0.15	±0.12	6.82	7.30	7.70	±0.55	±1.05	±0.75	±2.00	±0.10	±0.10	
400MD	-400	400	mbar	2000	4000	10,000	±0.15	±0.12	10.90	11.60	12.30	±0.35	±0.65	±0.75	±2.00	±0.10	±0.10	
600MD	-600	600	mbar	4000	8000	10,000	±0.15	±0.075	5.88	16.10	6.36	±0.40	±0.85	±0.50	±1.25	±0.10	±0.10	
001BD	-1	1	bar	4	8	10	±0.15	±0.075	9.80	10.20	10.60	±0.25	±0.50	±0.50	±1.25	±0.10	±0.10	
1.6BD	-1.6	1.6	bar	4	8	10	±0.15	±0.075	15.68	16.30	16.96	±0.15	±0.30	±0.50	±1.25	±0.10	±0.10	
2.5BD	-2.5	2.5	bar	8	17	10	±0.15	±0.075	12.20	12.70	13.18	±0.20	±0.40	±0.50	±1.50	±0.10	±0.10	
004BD	-4	4	bar	10	17	15	±0.15	±0.075	11.14	11.60	12.08	±0.25	±0.50	±0.50	±1.25	±0.10	±0.10	
006BD	-6	6	bar	17	17	15	±0.15	±0.075	10.16	10.60	11.08	±0.35	±0.50	±0.50	±1.00	±0.10	±0.10	
010BD	-10	10	bar	17	17	15	±0.15	±0.075	16.94	17.70	18.44	±0.20	±0.3	±0.5	±1.00	±0.10	±0.10	
Gage																		
060MG	0	60	mbar	872	1370	10,000	±0.20	±0.075	1.23	1.30	1.40	±1.15	±2.35	±1.00	±2.00	±0.30	±0.30	
100MG	0	100	mbar	872	1370	10,000	±0.20	±0.075	2.06	2.20	2.33	±0.70	±1.40	±1.00	±2.00	±0.20	±0.20	
160MG	0	160	mbar	2000	4000	10,000	±0.15	±0.12	2.18	2.30	2.46	±1.65	±3.30	±0.75	±2.00	±0.20	±0.20	
250MG	0	250	mbar	2000	4000	10,000	±0.15	±0.12	3.41	3.65	3.85	±1.05	±2.10	±0.75	±2.00	±0.15	±0.15	
400MG	0	400	mbar	2000	4000	10,000	±0.15	±0.12	5.45	5.80	6.15	±0.65	±1.30	±0.75	±2.00	±0.10	±0.10	
600MG	0	600	mbar	4000	8000	10,000	±0.15	±0.075	2.94	3.05	3.18	±0.85	±1.65	±0.50	±1.25	±0.15	±0.15	
001BG	0	1	bar	4	8	10	±0.15	±0.075	4.90	5.10	5.30	±0.50	±1.00	±0.50	±1.25	±0.10	±0.10	
1.6BG	0	1.6	bar	4	8	10	±0.15	±0.075	7.84	8.15	8.48	±0.30	±0.65	±0.50	±1.25	±0.10	±0.10	
2.5BG	0	2.5	bar	8	17	10	±0.15	±0.075	6.10	6.35	6.59	±0.40	±0.80	±0.50	±1.50	±0.10	±0.10	
004BG	0	4	bar	10	17	15	±0.15	±0.075	5.57	5.80	6.04	±0.50	±1.00	±0.50	±1.25	±0.10	±0.10	
006BG	0	6	bar	17	17	15	±0.15	±0.075	5.08	5.30	5.54	±0.65	±1.00	±0.50	±1.00	±0.15	±0.15	
010BG	0	10	bar	17	17	15	±0.15	±0.075	8.47	8.85	9.22	±0.40	±0.60	±0.50	±1.00	±0.10	±0.10	

¹Offset: The output signal obtained when the reference pressure is applied to all available pressure ports. Also known as “null” or “zero”.

²Thermal effect on offset: The deviation in offset due to changes in temperature over the compensated temperature range, relative to offset measured at 25 °C.

³Thermal effect on span: The deviation in full scale span due to changes in temperature over the compensated temperature range, relative to full scale span measured at 25 °C.

⁴Thermal hysteresis: The maximum difference between output readings when the same temperature is reached consecutively, under the same operating conditions, with temperature approaching from opposite directions within the operating temperature range. Validated over the full operating temperature and pressure ranges using a -5 °C/minute ramp and 30 minute dwell. Application performance may be affected by the thermal mass of the end user system.

TSC Series Specifications

±6 kPa to ±1 MPa

Table 7. TSC Series Pressure Range Specifications for ±6 kPa to ±1 MPa

Pressure Range Order Code (see Figure 1)	Pressure Range		Unit	Over Pressure	Burst Pressure	Common Mode Pressure	Pressure Accuracy (%FSS)	Offset ¹ (mV/V)	Full Scale Span (mV/V)			Thermal Effect on Offset ² (%FSS)		Thermal Effect on Span ³ (%FSS)		Long-Term Stability 1000 hr, 25 °C (%FSS)	Thermal Hysteresis ⁴ (%FSS)
	Pmin.	Pmax.							Min.	Nom.	Max.	10 °C to 50 °C	0 °C to 85 °C	10 °C to 50 °C	0 °C to 85 °C		
Differential																	
006KD	-6	6	kPa	87	137	1000	±0.20	±0.075	2.46	2.60	2.80	±0.60	±1.15	±1.00	±2.00	±0.15	±0.15
010KD	-10	10	kPa	87	137	1000	±0.20	±0.075	4.12	4.40	4.66	±0.35	±0.70	±1.00	±2.00	±0.10	±0.10
016KD	-16	16	kPa	200	400	1000	±0.15	±0.12	4.36	4.60	4.92	±0.80	±1.65	±0.75	±2.00	±0.10	±0.10
025KD	-25	25	kPa	200	400	1000	±0.15	±0.12	6.82	7.30	7.70	±0.55	±1.05	±0.75	±2.00	±0.10	±0.10
040KD	-40	40	kPa	200	400	1000	±0.15	±0.12	10.90	11.60	12.30	±0.35	±0.65	±0.75	±2.00	±0.10	±0.10
060KD	-60	60	kPa	400	800	1000	±0.15	±0.075	5.88	16.10	6.36	±0.40	±0.85	±0.50	±1.25	±0.10	±0.10
100KD	-100	100	kPa	400	800	1000	±0.15	±0.075	9.80	10.20	10.60	±0.25	±0.50	±0.50	±1.25	±0.10	±0.10
160KD	-160	160	kPa	400	800	1000	±0.15	±0.075	15.68	16.30	16.96	±0.15	±0.30	±0.50	±1.25	±0.10	±0.10
250KD	-250	250	kPa	800	1700	1000	±0.15	±0.075	12.20	12.70	13.18	±0.20	±0.40	±0.50	±1.50	±0.10	±0.10
400KD	-400	400	kPa	1000	1700	1600	±0.15	±0.075	11.14	11.60	12.08	±0.25	±0.50	±0.50	±1.25	±0.10	±0.10
600KD	-600	600	kPa	1700	1700	1700	±0.15	±0.075	10.16	10.60	11.08	±0.35	±0.50	±0.50	±1.00	±0.10	±0.10
001GD	-1	1	MPa	1.70	1.70	1.7	±0.15	±0.075	16.94	17.70	18.44	±0.20	±0.30	±0.50	±1.00	±0.10	±0.10
Gage																	
006KG	0	6	kPa	87	137	1000	±0.20	±0.075	1.23	1.30	1.40	±1.15	±2.35	±1.00	±2.00	±0.30	±0.30
010KG	0	10	kPa	87	137	1000	±0.20	±0.075	2.06	2.20	2.33	±0.70	±1.40	±1.00	±2.00	±0.20	±0.20
016KG	0	16	kPa	200	400	1000	±0.15	±0.12	2.18	2.30	2.46	±1.65	±3.30	±0.75	±2.00	±0.20	±0.20
025KG	0	25	kPa	200	400	1000	±0.15	±0.12	3.41	3.65	3.85	±1.05	±2.10	±0.75	±2.00	±0.15	±0.15
040KG	0	40	kPa	200	400	1000	±0.15	±0.12	5.45	5.80	6.15	±0.65	±1.30	±0.75	±2.00	±0.10	±0.10
060KG	0	60	kPa	400	800	1000	±0.15	±0.075	2.94	3.05	3.18	±0.85	±1.65	±0.50	±1.25	±0.15	±0.15
100KG	0	100	kPa	400	800	1000	±0.15	±0.075	4.90	5.10	5.30	±0.50	±1.00	±0.50	±1.25	±0.10	±0.10
160KG	0	160	kPa	400	800	1000	±0.15	±0.075	7.84	8.15	8.48	±0.30	±0.65	±0.50	±1.25	±0.10	±0.10
250KG	0	250	kPa	800	1700	1000	±0.15	±0.075	6.10	6.35	6.59	±0.40	±0.80	±0.50	±1.50	±0.10	±0.10
400KG	0	400	kPa	1000	1700	1600	±0.15	±0.075	5.57	5.80	6.04	±0.50	±1.00	±0.50	±1.25	±0.10	±0.10
600KG	0	600	kPa	1700	1700	1700	±0.15	±0.075	5.08	5.30	5.54	±0.65	±1.00	±0.50	±1.00	±0.15	±0.15
001GG	0	1	MPa	1.70	1.70	1.7	±0.15	±0.075	8.47	8.85	9.22	±0.40	±0.60	±0.50	±1.00	±0.10	±0.10

¹Offset: The output signal obtained when the reference pressure is applied to all available pressure ports. Also known as “null” or “zero”.

²Thermal effect on offset: The deviation in offset due to changes in temperature over the compensated temperature range, relative to offset measured at 25 °C.

³Thermal effect on span: The deviation in full scale span due to changes in temperature over the compensated temperature range, relative to full scale span measured at 25 °C.

⁴Thermal hysteresis: The maximum difference between output readings when the same temperature is reached consecutively, under the same operating conditions, with temperature approaching from opposite directions within the operating temperature range. Validated over the full operating temperature and pressure ranges using a ~5 °C/minute ramp and 30 minute dwell. Application performance may be affected by the thermal mass of the end user system.

TSC Series Specifications

±1 psi to ±150 psi

Table 8. TSC Series Pressure Range Specifications for ±1 psi to ±150 psi

Pressure Range Order Code (see Figure 1)	Pressure Range		Unit	Over Pressure	Burst Pressure	Common Mode Pressure	Pressure Accuracy (%FSS)	Offset ¹ (mV/V)	Full Scale Span (mV/V)			Thermal Effect on Offset ² (%FSS)		Thermal Effect on Span ³ (%FSS)		Long-Term Stability 1000 hr, 25 °C (%FSS)	Thermal Hysteresis ⁴ (%FSS)
	Pmin.	Pmax.							Min.	Nom.	Max.	10 °C to 50 °C	0 °C to 85 °C	10 °C to 50 °C	0 °C to 85 °C		
Differential																	
001PD	-1	1	psi	12.5	20	145	±0.20	±0.075	2.84	3.00	3.22	±0.50	±1.00	±1.00	±2.00	±0.15	±0.15
005PD	-5	5	psi	30	60	145	±0.15	±0.12	9.40	10.00	10.60	±0.40	±0.75	±0.75	±2.00	±0.10	±0.10
015PD	-15	15	psi	60	115	145	±0.15	±0.075	10.12	10.50	10.98	±0.25	±0.50	±0.50	±1.25	±0.10	±0.10
030PD	-30	30	psi	115	245	145	±0.15	±0.075	10.10	10.50	10.90	±0.25	±0.50	±0.50	±1.50	±0.10	±0.10
060PD	-60	60	psi	145	245	230	±0.15	±0.075	11.52	12.00	12.48	±0.25	±0.50	±0.50	±1.25	±0.10	±0.10
100PD	-100	100	psi	245	245	245	±0.15	±0.075	11.66	12.00	12.72	±0.30	±0.45	±0.50	±1.00	±0.10	±0.10
150PD	-150	150	psi	245	245	245	±0.15	±0.075	17.50	18.30	19.08	±0.20	±0.30	±0.50	±1.00	±0.10	±0.10
Gage																	
001PG	0	1	psi	12.7	20	145	±0.20	±0.075	1.42	1.50	1.61	±1.00	±2.05	±1.00	±2.00	±0.25	±0.25
005PG	0	5	psi	30	60	145	±0.15	±0.12	4.70	5.00	5.30	±0.75	±1.50	±0.75	±2.00	±0.10	±0.10
015PG	0	15	psi	60	115	145	±0.15	±0.075	5.06	5.25	5.49	±0.50	±0.95	±0.50	±1.25	±0.10	±0.10
030PG	0	30	psi	115	245	145	±0.15	±0.075	5.05	5.25	5.45	±0.50	±0.95	±0.50	±1.50	±0.10	±0.10
060PG	0	60	psi	145	245	230	±0.15	±0.075	5.76	6.00	6.24	±0.50	±0.95	±0.50	±1.25	±0.10	±0.10
100PG	0	100	psi	245	245	245	±0.15	±0.075	5.83	6.10	6.36	±0.60	±0.85	±0.50	±1.00	±0.10	±0.10
150PG	0	150	psi	245	245	245	±0.15	±0.075	8.75	9.15	9.54	±0.40	±0.60	±0.50	±1.00	±0.10	±0.10

¹Offset: The output signal obtained when the reference pressure is applied to all available pressure ports. Also known as “null” or “zero”.

²Thermal Effect on Offset: The deviation in offset due to changes in temperature over the compensated temperature range, relative to offset measured at 25 °C.

³Thermal Effect on Span: The deviation in full scale span due to changes in temperature over the compensated temperature range, relative to full scale span measured at 25 °C.

⁴Thermal Hysteresis: The maximum difference between output readings when the same temperature is reached consecutively, under the same operating conditions, with temperature approaching from opposite directions within the operating temperature range. Validated over the full operating temperature and pressure ranges using a ~5 °C/minute ramp and 30 minute dwell. Application performance may be affected by the thermal mass of the end user system.

Figure 3. TSC Series Typical Temperature Performance

The graph below indicates typical error multipliers for Thermal Effect on Offset (TEO) and Thermal Effect on Span (TES) outside the Compensated Temperature Range. See Tables 6-8 for details of the specified maximum errors within the Compensated Temperature Range.

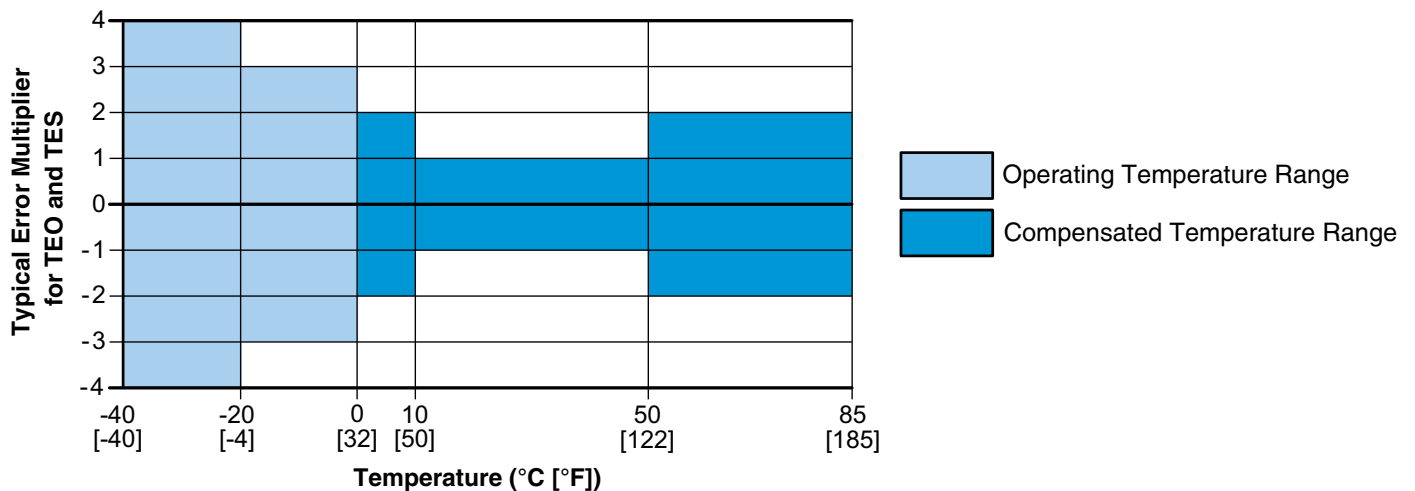

NSC Series Specifications

±2.5 mbar to ±10 bar

Table 9. NSC Series Pressure Range Specifications for ±2.5 mbar to ±10 bar

Pressure Range Order Code (see Figure 2)	Pressure Range		Unit	Working Pressure	Over Pressure	Burst Pressure	Common Mode Pressure	Offset ¹ (mV/V)			Full Scale Span (mV/V)			TCO ² (%FSS/25 °C)			TCS ³ (%FSS/25 °C)			Input Resistance ⁴ (kOhm)			TCR ⁵ (-40 °C to 25 °C) (ppm/°C)			TCR ⁵ (25 °C to 85 °C) (ppm/°C)			Long-Term Stability 1000 hr, 25 °C (%FSS)	Accuracy (%FSS)
	Pmin.	Pmax.						Min.	Nom.	Max.	Min.	Nom.	Max.	Min.	Nom.	Max.	Min.	Nom.	Max.	Min.	Nom.	Max.	Min.	Nom.	Max.	Min.	Nom.	Max.		
Absolute																														
001BA	0	1	bar	-	2	4.1	N/A	-6.0	0.0	6.0	10.0	14.5	19.0	-3.8	0.0	3.8	-7.5	-5	-3.0	2.6	3.5	4.4	500	1000	1500	1500	2000	2500	±0.25	±0.25
1.6BA	0	1.6	bar	-	4.1	8	N/A	-6.0	0.0	6.0	7.7	11.4	15.2	-4.9	0.0	4.9	-7.5	-5	-3.0	2.6	3.5	4.4	500	1000	1500	1500	2000	2500	±0.25	±0.25
2.5BA	0	2.5	bar	-	4.1	8	N/A	-6.0	0.0	6.0	12.0	17.9	23.8	-3.1	0.0	3.1	-7.5	-5	-3.0	2.6	3.5	4.4	500	1000	1500	1500	2000	2500	±0.20	±0.25
004BA	0	4	bar	-	8	17	N/A	-6.0	0	6.0	10.3	14.7	19.0	-3.6	0.0	3.6	-7.5	-5	-3.0	2.6	3.5	4.4	500	1000	1500	1500	2000	2500	±0.25	±0.25
006BA	0	6	bar	-	17	17	N/A	-6.0	0.0	6.0	7.9	11.0	14.0	-4.8	0.0	4.8	-7.5	-5	-3.0	2.6	3.5	4.4	500	1000	1500	1500	2000	2500	±0.25	±0.25
010BA	0	10	bar	-	17	17	N/A	-6.0	0.0	6.0	13.2	18.3	23.4	-2.9	0.0	2.9	-7.5	-5	-3.0	2.6	3.5	4.4	500	1000	1500	1500	2000	2500	±0.20	±0.25
Differential																														
2.5MD	-2.5	2.5	mbar	335	675	1000	3450	-24	-4	16	10.5	15.8	21.	-3.0	5.1	13.3	-8.9	-6	-3.8	2.5	3.3	4	1800	2175	2550	1300	1525	1750	±0.50	±0.25
004MD	-4	4	mbar	335	675	1000	3450	-24	-4	16	16.9	25.3	33.7	-1.9	3.2	8.3	-8.9	-6	-3.8	2.5	3.3	4	1800	2175	2550	1300	1525	1750	±0.30	±0.25
006MD	-6	6	mbar	335	675	1000	3450	-24	-4	16	25.3	37.9	50.6	-1.2	2.1	5.5	-8.9	-6	-3.8	2.5	3.3	4	1800	2175	2550	1300	1525	1750	±0.20	±0.25
010MD	-10	10	mbar	375	745	1250	5450	-24	-4	16	35.2	52.6	70.0	-1.9	1.8	5.5	-8.9	-6	-3.8	2.5	3.3	4	1800	2175	2550	1300	1525	1750	±0.25	±0.25
016MD	-16	16	mbar	435	850	1350	10,450	-8.0	-2.0	4.0	6.7	10.1	13.5	-3.1	0.8	4.7	-8.9	-6	-3.8	2.5	3.3	4	1800	2175	2550	1300	1525	1750	±0.40	±0.25
025MD	-25	25	mbar	435	850	1350	10,450	-8.0	-2.0	4.0	10.5	15.8	21.1	-2.0	0.5	3.0	-8.9	-6	-3.8	2.5	3.3	4	1800	2175	2550	1300	1525	1750	±0.25	±0.25
040MD	-40	40	mbar	435	850	1380	10,450	-8.5	-2.5	3.5	5.2	7.5	9.9	-1.9	0.9	1.9	-6.3	-5	-3.8	4	5	6	1200	1700	2550	2220	2700	3200	±0.30	±0.25
060MD	-60	60	mbar	435	850	1380	10,450	-8.5	-2.5	3.5	7.8	11.3	14.8	-1.3	0.6	1.3	-6.3	-5	-3.8	4	5	6	1200	1700	2200	2220	2700	3200	±0.20	±0.25
100MD	-100	100	mbar	435	850	1380	10,450	-8.5	-2.5	3.5	13.1	18.9	24.7	-0.8	0.3	0.8	-6.3	-5	-3.8	4	5	6	1200	1700	2200	2220	2700	3200	±0.15	±0.25
160MD	-160	160	mbar	435	850	1380	10,450	-8.5	-2.5	3.5	20.9	30.2	39.5	-0.5	0.2	0.5	-6.3	-5	-3.8	4	5	6	1200	1700	2200	2220	2700	3200	±0.15	±0.25
250MD	-250	250	mbar	-	1380	2760	10,000	-8.5	-2.5	3.5	14.5	21.8	29.0	-0.7	0.3	0.7	-6.3	-5	-3.8	4	5	6	1200	1700	2200	2220	2700	3200	±0.25	±0.25
400MD	-400	400	mbar	-	1380	2760	10,000	-8.5	-2.5	3.5	23.2	34.8	46.4	-0.4	0.2	0.4	-6.3	-5	-3.8	4	5	6	1200	1700	2200	2220	2700	3200	±0.15	±0.25
600MD	-600	600	mbar	-	2060	4100	10,000	-7.0	-0.85	5.3	12.0	18.0	24.0	-0.8	0.5	0.8	-6.0	-5	-3.8	2.4	3	5.5	1200	1700	2200	2220	2700	3200	±0.20	±0.25
001BD	-1	1	bar	-	2	4.1	10	-7.0	-0.85	5.3	20.0	30.0	40.0	-0.6	0.3	0.5	-6.0	-5	-3.8	2.4	3	5.5	1200	1700	2200	2220	2700	3200	±0.15	±0.25
1.6BD	-1.6	1.6	bar	-	4.1	8	10	-7.0	-0.85	5.3	24.0	32.0	40.0	-0.4	0.3	0.4	-6.0	-5	-3.8	2.4	3	5.5	1200	1700	2200	2220	2700	3200	±0.15	±0.25
2.5BD	-2.5	2.5	bar	-	4.1	8	10	-7.0	-0.85	5.3	37.5	50.0	62.5	-0.3	0.2	0.3	-6.0	-5	-3.8	2.4	3	5.5	1200	1700	2200	2220	2700	3200	±0.10	±0.25
004BD	-4	4	bar	-	8	17	17	-7.0	-0.85	5.3	33.6	40.0	46.4	-0.3	0.2	0.3	-6.0	-5	-3.8	2.4	3	5.5	1200	1700	2200	2220	2700	3200	±0.15	±0.25
006BD	-6	6	bar	-	17	17	17	-7.0	-0.85	5.3	25.2	30.0	34.8	-0.4	0.3	0.4	-6.0	-5	-3.8	2.4	3	5.5	1200	1700	2200	2220	2700	3200	±0.15	±0.25
010BD	-10	10	bar	-	17	17	17	-7.0	-0.85	5.3	42.0	50.0	58.0	-0.2	0.1	0.2	-6.0	-5	-3.8	2.4	3	5.5	1200	1700	2200	2220	2700	3200	±0.10	±0.25
Gage																														
004MG	0	4	mbar	335	675	1000	3440	-24	-4	16	8.4	12.6	16.9	-3.7	6.4	16.6	-8.9	-6	-3.8	2.5	3.3	4	1800	2175	2550	1300	1525	1750	±0.50	±0.25
006MG	0	6	mbar	335	675	1000	3440	-24	-4	16	12.6	19.0	25.3	-2.5	4.3	11.0	-8.9	-6	-3.8	2.5	3.3	4	1800	2175	2550	1300	1525	1750	±0.40	±0.25
010MG	0	10	mbar	375	745	1245	5440	-24	-4	16	17.6	26.3	35.0	-3.8	3.6	11.0	-8.9	-6	-3.8	2.5	3.3	4	1800	2175	2550	1300	1525	1750	±0.50	±0.25
016MG	0	16	mbar	435	850	1350	10,440	-8.5	-2.0	4.0	3.4	5.1	6.7	-6.2	1.6	9.3	-8.9	-6	-3.8	2.5	3.3	4	1800	2175	2550	1300	1525	1750	±0.50	±0.25
025MG	0	25	mbar	435	850	1350	10,440	-8.5	-2.0	4.0	5.3	7.9	10.5	-4.0	1.0	6.0	-8.9	-6	-3.8	2.5	3.3	4	1800	2175	2550	1300	1525	1750	±0.50	±0.25
040MG	0	40	mbar	435	850	1380	10,440	-8.5	-2.5	3.5	2.6	3.8	4.9	-3.8	1.7	3.8	-6.3	-5	-3.8	4	5	6	1200	1700	2200	2220	2700	3200	±0.50	±0.25
060MG	0	60	mbar	435	850	1380	10,440	-8.5	-2.5	3.5	3.9	5.7	7.4	-2.6	1.1	2.6	-6.3	-5	-3.8	4	5	6	1200	1700	2200	2220	2700	3200	±0.40	±0.25
100MG	0	100	mbar	435	850	1380	10,440	-8.5	-2.5	3.5	6.5	9.4	12.3	-1.5	0.7	1.5	-6.3	-5	-3.8	4	5	6	1200	1700	2200	2220	2700	3200	±0.25	±0.25
160MG	0	160	mbar	435	850	1380	10,440	-8.5	-2.5	3.5	10.4	15.1	19.7	-1.0	0.4	1.0	-6.3	-5	-3.8	4	5	6	1200	1700	2200	2220	2700	3200	±0.15	±0.25
250MG	0	250	mbar	-	1380	2760	10,000	-8.5	-2.5	3.5	7.3	10.9	14.5	-1.4	0.6	1.4	-6.3	-5	-3.8	4	5	6	1200	1700	2200	2220	2700	3200	±0.35	±0.25
400MG	0	400	mbar	-	1380	2760	10,000	-8.5	-2.5	3.5	11.6	17.4	23.2	-0.9	0.3	0.9	-6.3	-5	-3.8	4	5	6	1200	1700	2200	2220	2700	3200	±0.30	±0.25
600MG	0	600	mbar	-	2060	4100	10,000	-7.0	-0.85	5.3	6.0	9.0	12.0	-1.7	1.0	1.7	-6.0	-5	-3.8	2.4	3	5.5	1200	1700	2200	2220	2700	3200	±0.25	±0.25
001BG	0	1	bar	-	2	4.1	10	-7.0	-0.85	5.3	10.0	15.0	20.0	-1.0	0.6	1.0	-6.0	-5	-3.8	2.4	3	5.5	1200	1700	2200	2220	2700	3200	±0.25	±0.25
1.6BG	0	1.6	bar	-	4.1	8	10	-7.0	-0.85	5.3	12.0	16.0	20.0	-0.8	0.5	0.8	-6.0	-5	-3.8	2.4	3	5.5	1200	1700	2200	2220	2700	3200	±0.25	±0.25
2.5BG	0	2.5	bar	-	4.1	8	10	-7.0	-0.85	5.3	18.8	25.0	31.3	-0.6	0.3	0.5	-6.0	-5	-3.8	2.4	3	5.5	1200	1700	2200	2220	2700	3200	±0.20	±0.25
004BG	0	4	bar	-	8	17	17	-7.0	-0.85	5.3	16.8	20.0	23.2	-0.6	0.4	0.6	-6.0	-5	-3.8	2.4	3	5.5	1200	1700	2200	2220	2700	3200	±0.25	±0.25
006BG	0	6	bar	-	17	17	17	-7.0	-0.85	5.3	12.6	15.0	17.4	-0.8	0.6	0.8	-6.0	-6	-3.8	2.4	3	5.5	1200	1700	2200	2220	2700	3200	±0.25	±0.25
010BG	0	10	bar	-	17	17	17	-7.0	-0.85	5.3	21.0	25.0	29.0	-0.5	0.4	0.5	-6.0	-6	-3.8	2.4	3	5.5	1200	1700	2200	2220	2700	3200	±0.20	±0.25

¹Offset: The output signal obtained when the reference pressure is applied to all available pressure ports. Also known as “null” or “zero”.

²TCO (Thermal Coefficient of Offset): The deviation in offset due to changes in temperature over the compensated temperature range, relative to offset measured at 25 °C.

³TCS (Thermal Coefficient of Span): The deviation in full scale span due to changes in temperature over the compensated temperature range, relative to full scale span measured at 25 °C.

⁴Input Resistance at 25 °C, 5 Vdc supply.

⁵TCR (Thermal Coefficient of Resistance): The deviation in input resistance due to changes in temperature over the specified temperature range, relative to input resistance measured at 25 °C.

NSC Series Specifications

±250 Pa to ±1 Mpa

Table 10. NSC Series Pressure Range Specifications for ±250 Pa to ±1 MPa

Pressure Range Order Code (see Figure 2)	Pressure Range		Unit	Working Pressure	Over Pressure	Burst Pressure	Common Mode Pressure	Offset ¹ (mV/V)			Full Scale Span (mV/V)			TCO ² (%FSS/25 °C)			TCS ³ (%FSS/25 °C)			Input Resistance ⁴ (kOhm)			TCR ⁵ (-40 °C to 25 °C) (ppm/°C)			TCR ⁵ (25 °C to 85 °C) (ppm/°C)			Long-Term Stability 1000 hr, 25 °C(%FSS)	Accuracy (%FSS)
	Pmin.	Pmax.						Min.	Nom.	Max.	Min.	Nom.	Max.	Min.	Nom.	Max.	Min.	Nom.	Max.	Min.	Nom.	Max.	Min.	Nom.	Max.	Min.	Nom.	Max.		
Absolute																														
100KA	0	100	kPa	-	200	400	N/A	-6	0	6	10.0	14.5	19.0	-3.8	0.0	3.8	-7.5	-5	-3.0	2.6	3.5	4.4	500	1000	1500	1500	2000	2500	±0.25	±0.25
160KA	0	160	kPa	-	400	800	N/A	-6	0	6	7.7	11.4	15.2	-4.9	0.0	4.9	-7.5	-5	-3.0	2.6	3.5	4.4	500	1000	1500	1500	2000	2500	±0.25	±0.25
250KA	0	250	kPa	-	400	800	N/A	-6	0	6	12.0	17.9	23.8	-3.1	0.0	3.1	-7.5	-5	-3.0	2.6	3.5	4.4	500	1000	1500	1500	2000	2500	±0.20	±0.25
400KA	0	400	kPa	-	800	1700	N/A	-6	0	6	10.3	14.7	19.0	-3.6	0.0	3.6	-7.5	-5	-3.0	2.6	3.5	4.4	500	1000	1500	1500	2000	2500	±0.25	±0.25
600KA	0	600	kPa	-	1700	1700	N/A	-6	0	6	7.9	11.0	14.0	-4.8	0.0	4.8	-7.5	-5	-3.0	2.6	3.5	4.4	500	1000	1500	1500	2000	2500	±0.25	±0.25
001GA	0	1	MPa	-	1.7	1.7	N/A	-6	0	6	13.2	18.3	23.4	-2.9	0.0	2.9	-7.5	-5	-3.0	2.6	3.5	4.4	500	1000	1500	1500	2000	2500	±0.20	±0.25
Differential																														
250LD	-250	250	Pa	33,500	67,500	100,000	345,000	-24	-4	16	10.5	15.8	21.1	-3.0	5.1	13.3	-8.9	-6	-3.8	2.5	3.3	4	1800	2175	2550	1300	1525	1750	±0.50	±0.25
400LD	-400	400	Pa	33,500	67,500	100,000	345,000	-24	-4	16	16.9	25.3	33.7	-1.9	3.2	8.3	-8.9	-6	-3.8	2.5	3.3	4	1800	2175	2550	1300	1525	1750	±0.30	±0.25
600LD	-600	600	Pa	33,500	67,500	100,000	345,000	-24	-4	16	25.3	37.9	50.6	-1.2	2.1	5.5	-8.9	-6	-3.8	2.5	3.3	4	1800	2175	2550	1300	1525	1750	±0.20	±0.25
001KD	-1	1	kPa	40	75	125	560	-24	-4	16	35.2	52.6	70.0	-1.9	1.8	5.5	-8.9	-6	-3.8	2.5	3.3	4	1800	2175	2550	1300	1525	1750	±0.25	±0.25
1.6KD	-1.6	1.6	kPa	40	75	125	560	-24	-4	16	56.3	84.1	112.0	-1.2	1.1	3.4	-8.9	-6	-3.8	2.5	3.3	4	1800	2175	2550	1300	1525	1750	±0.15	±0.25
2.5KD	-2.5	2.5	kPa	45	85	135	1040	-8	-2	-4	10.5	15.8	21.1	-2.0	0.5	3.0	-8.9	-6	-3.8	2.5	3.3	4	1800	2175	2550	1300	1525	1750	±0.25	±0.25
004KD	-4	4	kPa	45	85	140	1040	-8.5	-2.5	3.5	5.2	7.5	9.9	-1.9	0.9	1.9	-6.3	-5	-3.8	4	5	6	1200	1700	2200	2220	2700	3200	±0.30	±0.25
006KD	-6	6	kPa	45	85	140	1040	-8.5	-2.5	3.5	7.8	11.3	14.8	-1.3	0.6	1.3	-6.3	-5	-3.8	4	5	6	1200	1700	2200	2220	2700	3200	±0.20	±0.25
010KD	-10	10	kPa	45	85	140	1040	-8.5	-2.5	3.5	13.1	18.9	24.7	-0.8	0.3	0.8	-6.3	-5	-3.8	4	5	6	1200	1700	2200	2220	2700	3200	±0.15	±0.25
016KD	-16	16	kPa	45	85	140	1040	-8.5	-2.5	3.5	20.9	30.2	39.5	-0.5	0.2	0.5	-6.3	-5	-3.8	4	5	6	1200	1700	2200	2220	2700	3200	±0.15	±0.25
025KD	-25	25	kPa	-	140	275	1000	-8.5	-2.5	3.5	14.5	21.8	29.0	-0.7	0.3	0.7	-6.3	-5	-3.8	4	5	6	1200	1700	2200	2220	2700	3200	±0.25	±0.25
040KD	-40	40	kPa	-	140	275	1000	-8.5	-2.5	3.5	23.2	34.8	46.4	-0.4	0.2	0.4	-6.3	-5	-3.8	4	5	6	1200	1700	2200	2220	2700	3200	±0.15	±0.25
060KD	-60	60	kPa	-	200	400	1000	-7	-0.85	5.3	12.0	18.0	24.0	-0.8	0.5	0.8	-6.0	-5	-3.8	2.4	3	5.5	1200	1700	2200	2220	2700	3200	±0.20	±0.25
100KD	-100	100	kPa	-	200	400	1000	-7	-0.85	5.3	20.0	30.0	40.0	-0.5	0.3	0.5	-6.0	-5	-3.8	2.4	3	5.5	1200	1700	2200	2220	2700	3200	±0.15	±0.25
160KD	-160	160	kPa	-	410	800	1000	-7	-0.85	5.3	24.0	32.0	40.0	-0.4	0.3	0.4	-6.0	-5	-3.8	2.4	3	5.5	1200	1700	2200	2220	2700	3200	±0.15	±0.25
250KD	-250	250	kPa	-	410	800	1000	-7	-0.85	5.3	37.5	50.0	62.5	-0.2	0.2	0.2	-6.0	-5	-3.8	2.4	3	5.5	1200	1700	2200	2220	2700	3200	±0.10	±0.25
400KD	-400	400	kPa	-	800	1700	1700	-7	-0.85	5.3	33.6	40.0	46.4	-0.3	0.2	0.3	-6.0	-5	-3.8	2.4	3	5.5	1200	1700	2200	2220	2700	3200	±0.15	±0.25
600KD	-600	600	kPa	-	1700	1700	1700	-7	-0.85	5.3	25.2	30.0	34.8	-0.4	0.3	0.4	-6.0	-5	-3.8	2.4	3	5.5	1200	1700	2200	2220	2700	3200	±0.15	±0.25
001GD	-1	1	MPa	-	1.7	1.7	17	-7	-0.85	5.3	42.0	50.0	58.0	-0.2	0.2	0.2	-6.0	-5	-3.8	2.4	3	5.5	1200	1700	2200	2220	2700	3200	±0.10	±0.25
Gage																														
400LG	0	400	Pa	33,500	67,500	100,000	345,000	-24	-4	16	8.4	12.6	16.9	-3.7	6.4	16.6	-8.9	-6	-3.8	2.5	3.3	4	1800	2175	2550	1300	1525	1750	±0.50	±0.25
600LG	0	600	Pa	33,500	67,500	100,000	345,000	-24	-4	16	12.6	19.0	25.3	-2.5	4.3	11.0	-8.9	-6	-3.8	2.5	3.3	4	1800	2175	2550	1300	1525	1750	±0.40	±0.25
001KG	0	1	kPa	40	75	125	560	-24	-4	16	17.6	26.3	35.0	-3.8	3.6	11.0	-8.9	-6	-3.8	2.5	3.3	4	1800	2175	2550	1300	1525	1750	±0.50	±0.25
1.6KG	0	1.6	kPa	40	75	125	560	-24	-4	16	28.1	42.1	56.0	-2.4	2.2	6.9	-8.9	-6	-3.8	2.5	3.3	4	1800	2175	2550	1300	1525	1750	±0.30	±0.25
004KG	0	4	kPa	45	85	140	1040	-8.5	-2.5	3.5	2.6	3.8	4.9	-3.8	1.7	3.8	-6.3	-5	-3.8	4	5	6	1200	1700	2200	2220	2700	3200	±0.50	±0.25
006KG	0	6	kPa	45	85	140	1040	-8.5	-2.5	3.5	3.9	5.7	7.4	-2.5	1.1	2.5	-6.3	-5	-3.8	4	5	6	1200	1700	2200	2220	2700	3200	±0.35	±0.25
010KG	0	10	kPa	45	85	140	1040	-8.5	-2.5	3.5	6.5	9.4	12.3	-1.5	0.7	1.5	-6.3	-5	-3.8	4	5	6	1200	1700	2200	2220	2700	3200	±0.25	±0.25
016KG	0	16	kPa	45	85	140	1040	-8.5	-2.5	3.5	10.4	15.1	19.7	-0.9	0.4	0.9	-6.3	-5	-3.8	4	5	6	1200	1700	2200	2220	2700	3200	±0.15	±0.25
025KG	0	25	kPa	-	140	275	1000	-8.5	-2.5	3.5	7.3	10.9	14.5	-1.4	0.6	1.4	-6.3	-5	-3.8	4	5	6	1200	1700	2200	2220	2700	3200	±0.35	±0.25
040KG	0	40	kPa	-	140	275	1000	-8.5	-2.5	3.5	11.6	17.4	23.2	-0.9	0.3	0.9	-6.3	-5	-3.8	4	5	6	1200	1700	2200	2220	2700	3200	±0.30	±0.25
060KG	0	60	kPa	-	200	400	1000	-7	-0.85	5.3	6.0	9.0	12.0	-1.7	1.0	1.7	-6	-5	-3.8	2.4	3	5.5	1200	1700	2200	2220	2700	3200	±0.25	±0.25
100KG	0	100	kPa	-	200	400	1000	-7	-0.85	5.3	10.0	15.0	20.0	-1.0	0.6	1.0	-6	-5	-3.8	2.4	3	5.5	1200	1700	2200	2220	2700	3200	±0.25	±0.25
160KG	0	160	kPa	-	410	800	1000	-7	-0.85	5.3	12.0	16.0	20.0	-0.8	0.5	0.8	-6	-5	-3.8	2.4	3	5.5	1200	1700	2200	2220	2700	3200	±0.25	±0.25
250KG	0	250	kPa	-	410	800	1000	-7	-0.85	5.3	18.8	25.0	31.3	-0.5	0.3	0.5	-6	-5	-3.8	2.4	3	5.5	1200	1700	2200	2220	2700	3200	±0.20	±0.25
400KG	0	400	kPa	-	800	1800	1720	-7	-0.85	5.3	16.8	20.0	23.2	-0.6	0.4	0.6	-6	-5	-3.8	2.4	3	5.5	1200	1700	2200	2220	2700	3200	±0.25	±0.25
600KG	0	600	kPa	-	1700	1800	1720	-7	-0.85	5.3	12.6	15.0	17.4	-0.8	0.6	0.8	-6	-6	-3.8	2.4	3	5.5	1200	1700	2200	2220	2700	3200	±0.25	±0.25
001GG	0	1	MPa	-	1.7	1.8	1.7	-7	-0.85	5.3	21.0	25.0	29.0	-0.5	0.3	0.5	-6	-6	-3.8	2.4	3	5.5	1200	1700	2200	2220	2700	3200	±0.20	±0.25

¹Offset: The output signal obtained when the reference pressure is applied to all available pressure ports. Also known as “null” or “zero”.

²TCO (Thermal Coefficient of Offset): The deviation in offset due to changes in temperature over the compensated temperature range, relative to offset measured at 25 °C.

³TCS (Thermal Coefficient of Span): The deviation in full scale span due to changes in temperature over the compensated temperature range, relative to full scale span measured at 25 °C.

⁴Input Resistance at 25 °C, 5 Vdc supply.

⁵TCR (Thermal Coefficient of Resistance): The deviation in input resistance due to changes in temperature over the specified temperature range, relative to input resistance measured at 25 °C.

NSC Series Specifications

±1 in H₂O to ±150 psi

Table 11. NSC Series Pressure Range Specifications for ±1 inH₂O to ±150 psi

Pressure Range Order Code (see Figure 2)	Pressure Range		Unit	Working Pressure	Over Pressure	Burst Pressure	Common Mode Pressure	Offset ¹ (mV/V)			Full Scale Span (mV/V)			TCO ² (%FSS/25 °C)			TCS ³ (%FSS/25 °C)			Input Resistance ³ (kOhm)			TCR ⁴ (-40°C to 25°C) (ppm/°C)			TCR ⁵ (25 °C to 85 °C) (ppm/°C)			Long-Term Stability 1000 hr, 25 °C (%FSS)	Accuracy (%FSS)
	Pmin.	Pmax.						Min.	Nom.	Max.	Min.	Nom.	Max.	Min.	Nom.	Max.	Min.	Nom.	Max.	Min.	Nom.	Max.	Min.	Nom.	Max.	Min.	Nom.	Max.		
Absolute																														
015PA	0	15	psi	-	30	60	N/A	-6.0	0	6.0	10.3	15.0	19.7	-3.6	0.0	3.6	-7.5	-5.0	-3.0	2.6	3.5	4.4	500	1000	1500	1500	2000	2500	±0.25	±0.25
030PA	0	30	psi	-	60	120	N/A	-6.0	0	6.0	9.9	14.8	19.7	-3.8	0.0	3.8	-7.5	-5.0	-3.0	2.6	3.5	4.4	500	1000	1500	1500	2000	2500	±0.25	±0.25
060PA	0	60	psi	-	120	250	N/A	-6.0	0	6.0	10.7	15.2	19.7	-3.5	0.0	3.5	-7.5	-5.0	-3.0	2.6	3.5	4.4	500	1000	1500	1500	2000	2500	±0.25	±0.25
100PA	0	100	psi	-	250	250	N/A	-6.0	0	6.0	9.1	12.6	16.1	-4.10	0.0	4.10	-7.5	-5.0	-3.0	2.6	3.5	4.4	500	1000	1500	1500	2000	2500	±0.25	±0.25
150PA	0	150	psi	-	250	250	N/A	-6.0	0	6.0	13.6	18.9	24.2	-2.8	0.0	2.8	-7.5	-5.0	-3.0	2.6	3.5	4.4	500	1000	1500	1500	2000	2500	±0.20	±0.25
Differential																														
001ND	-1	1	inH ₂ O	135	270	415	1400	-24	-4	16	10.5	15.7	21.0	-3.0	5.2	13.3	-8.9	-6	-3.8	2.5	3.3	4	1800	2175	2550	1300	1525	1750	0.50	±0.25
002ND	-2	2	inH ₂ O	135	270	415	1400	-24	-4	16	21.0	31.5	42.0	-1.5	2.6	6.7	-8.9	-6	-3.8	2.5	3.3	4	1800	2175	2550	1300	1525	1750	0.25	±0.25
004ND	-4	4	inH ₂ O	150	300	500	2200	-24	-4	16	35.0	52.4	69.8	-1.3	1.8	5.5	-8.9	-6	-3.8	2.5	3.3	4	1800	2175	2550	1300	1525	1750	0.25	±0.25
005ND	-5	5	inH ₂ O	150	300	500	2200	-24	-4	16	43.8	65.5	87.2	-1.5	1.4	4.4	-8.9	-6	-3.8	2.5	3.3	4	1800	2175	2550	1300	1525	1750	0.20	±0.25
010ND	-10	10	inH ₂ O	175	340	550	4200	-8.0	-2.0	4.0	10.5	15.7	21.0	-2.0	0.5	3.0	-8.9	-6	-3.8	2.5	3.3	4	1800	2175	2550	1300	1525	1750	0.25	±0.25
020ND	-20	20	inH ₂ O	175	340	550	4200	-8.5	-2.5	3.5	6.5	9.4	12.3	-1.5	0.7	1.5	-6.3	-5	-3.8	4	5	6	1200	1700	2200	2200	2700	3200	0.25	±0.25
030ND	-30	30	inH ₂ O	175	340	550	4200	-8.5	-2.5	3.5	9.8	14.1	18.4	-1.0	0.5	1.0	-6.3	-5	-3.8	4	5	6	1200	1700	2200	2200	2700	3200	0.15	±0.25
001PD	-1	1	psi	5	10	20	150	-8.5	-2.5	3.5	9.0	13.0	17.0	-1.1	0.5	1.1	-6.3	-5	-3.8	4	5	6	1200	1700	2200	2200	2700	3200	0.20	±0.25
005PD	-5	5	psi	-	20	40	150	-8.5	-2.5	3.5	20.0	30.0	40.0	-0.5	0.2	0.5	-6.3	-5	-3.8	4	5	6	1200	1700	2200	2200	2700	3200	0.20	±0.25
015PD	-15	15	psi	-	30	60	150	-7.0	-0.85	5.3	20.7	31.0	41.4	-0.5	0.3	0.5	-6	-5	-3.8	2.4	3	5.5	1200	1700	2200	2200	2700	3200	0.15	±0.25
030PD	-30	30	psi	-	60	120	150	-7.0	-0.85	5.3	31.0	41.4	51.7	-0.3	0.2	0.3	-6	-5	-3.8	2.4	3	5.5	1200	1700	2200	2200	2700	3200	0.15	±0.25
060PD	-60	60	psi	-	120	250	250	-7.0	-0.85	5.3	34.8	41.4	48.0	-0.3	0.2	0.3	-6	-5	-3.8	2.4	3	5.5	1200	1700	2200	2200	2700	3200	0.15	±0.25
100PD	-100	100	psi	-	250	250	250	-7.0	-0.85	5.3	29.0	34.5	40.0	-0.3	0.3	0.3	-6	-5	-3.8	2.4	3	5.5	1200	1700	2200	2200	2700	3200	0.15	±0.25
150PD	-150	150	psi	-	250	250	250	-7.0	-0.85	5.3	43.4	51.7	60.0	-0.2	0.2	0.2	-6	-5	-3.8	2.4	3	5.5	1200	1700	2200	2200	2700	3200	0.10	±0.25
Gage																														
002NG	0	2	inH ₂ O	135	270	415	1400	-24	-4	16	10.5	15.7	21.0	-3.0	5.2	13.3	-8.9	-6	-3.8	2.5	3.3	4	1800	2175	2550	1300	1525	1750	0.50	±0.25
004NG	0	4	inH ₂ O	150	300	500	2200	-24	-4	16	17.5	26.2	34.9	-3.8	3.6	11.0	-8.9	-6	-3.8	2.5	3.3	4	1800	2175	2550	1300	1525	1750	0.50	±0.25
005NG	0	5	inH ₂ O	150	300	500	2200	-24	-4	16	21.9	32.7	43.6	-3.0	2.9	8.8	-8.9	-6	-3.8	2.5	3.3	4	1800	2175	2550	1300	1525	1750	0.40	±0.25
010NG	0	10	inH ₂ O	175	340	550	4200	-8.0	-2.0	4.0	5.2	7.9	10.5	-4.0	1.0	6.0	-8.9	-6	-3.8	2.5	3.3	4	1800	2175	2550	1300	1525	1750	0.50	±0.25
020NG	0	20	inH ₂ O	175	340	550	4200	-8.5	-2.5	3.5	3.3	4.7	6.1	-3.0	1.4	3.0	-6.3	-5	-3.8	4	5	6	1200	1700	2200	2200	2700	3200	0.50	±0.25
030NG	0	30	inH ₂ O	175	340	550	4200	-8.5	-2.5	3.5	4.9	7.0	9.2	-2.0	0.9	2.0	-6.3	-5	-3.8	4	5	6	1200	1700	2200	2200	2700	3200	0.30	±0.25
001PG	0	1	psi	5	10	20	150	-8.5	-2.5	3.5	4.5	6.5	8.5	-2.2	1.0	2.2	-6.3	-5	-3.8	4	5	6	1200	1700	2200	2200	2700	3200	0.35	±0.25
005PG	0	5	psi	-	20	40	150	-8.5	-2.5	3.5	10.0	15.0	20.0	-1.0	0.4	1.0	-6.3	-5	-3.8	4	5	6	1200	1700	2200	2200	2700	3200	0.35	±0.25
015PG	0	15	psi	-	30	60	150	-7.0	-0.85	5.3	10.3	15.5	20.7	-1.0	0.6	1.0	-6.0	-5	-3.8	2.4	3	5.5	1200	1700	2200	2200	2700	3200	0.25	±0.25
030PG	0	30	psi	-	60	120	150	-7.0	-0.85	5.3	15.5	20.7	25.9	-0.6	0.4	0.6	-6.0	-5	-3.8	2.4	3	5.5	1200	1700	2200	2200	2700	3200	0.25	±0.25
060PG	0	60	psi	-	120	250	250	-7.0	-0.85	5.3	17.4	20.7	24.0	-0.6	0.4	0.6	-6.0	-5	-3.8	2.4	3	5.5	1200	1700	2200	2200	2700	3200	0.25	±0.25
100PG	0	100	psi	-	250	250	250	-7.0	-0.85	5.3	14.5	17.2	20.0	-0.7	0.5	0.7	-6.0	-5	-3.8	2.4	3	5.5	1200	1700	2200	2200	2700	3200	0.25	±0.25
150PG	0	150	psi	-	250	250	250	-7.0	-0.85	5.3	21.7	25.9	30.0	-0.6	0.3	0.6	-6.0	-5	-3.8	2.4	3	5.5	1200	1700	2200	2200	2700	3200	0.20	±0.25

¹Offset: The output signal obtained when the reference pressure is applied to all available pressure ports. Also known as “null” or “zero”.

²TCO (Thermal Coefficient of Offset): The deviation in offset due to changes in temperature over the compensated temperature range, relative to offset measured at 25 °C.













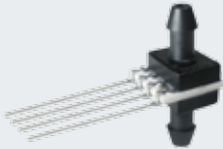

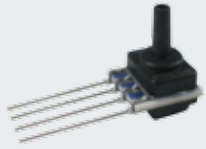

³TCS (Thermal Coefficient of Span): The deviation in full scale span due to changes in temperature over the compensated temperature range, relative to full scale span measured at 25 °C.

⁴Input Resistance at 25 °C, 5 Vdc supply.

⁵TCR (Thermal Coefficient of Resistance): The deviation in input resistance due to changes in temperature over the specified temperature range, relative to input resistance measured at 25 °C.

Available Standard Configurations

Figure 4. All Available Standard Configurations (Dimensional drawings on pages noted below.)

Package Code	Pressure Port		
	DIP	SMT	SIP
NN	 <i>page 18</i>	 <i>page 20</i>	 <i>page 23</i>
AA	—	—	 <i>page 23</i>
AN	 <i>page 18</i>	 <i>page 21</i>	 <i>page 24</i>
LN	 <i>page 18</i>	 <i>page 21</i>	 <i>page 24</i>
FF	—	—	 <i>page 24</i>
FN	—	—	 <i>page 25</i>
GN	—	—	 <i>page 25</i>
NB	—	—	 <i>page 25</i>
RN	 <i>page 19</i>	 <i>page 21</i>	 <i>page 26</i>

Available Standard Configurations

Figure 4. All Available Standard Configurations (Continued; dimensional drawings on pages noted below.)

Package Code	Pressure Port		
	DIP	SMT	SIP
RR	 <i>page 19</i>	 <i>page 22</i>	 <i>page 26</i>
DR	 <i>page 19</i>	 <i>page 22</i>	 <i>page 26</i>
JN	 <i>page 20</i>	 <i>page 22</i>	 <i>page 27</i>
JJ	 <i>page 20</i>	 <i>page 23</i>	 <i>page 27</i>
HH	—	—	 <i>page 27</i>
HN	—	—	 <i>page 28</i>
MN	—	—	 <i>page 28</i>
SN	—	—	 <i>page 28</i>

Dimensional Drawings

DIP Packages

Figure 5. DIP Package Dimensional Drawings (For reference only: mm [in])

Dimensions

DIP NN: No ports



DIP AN: Single axial barbed port

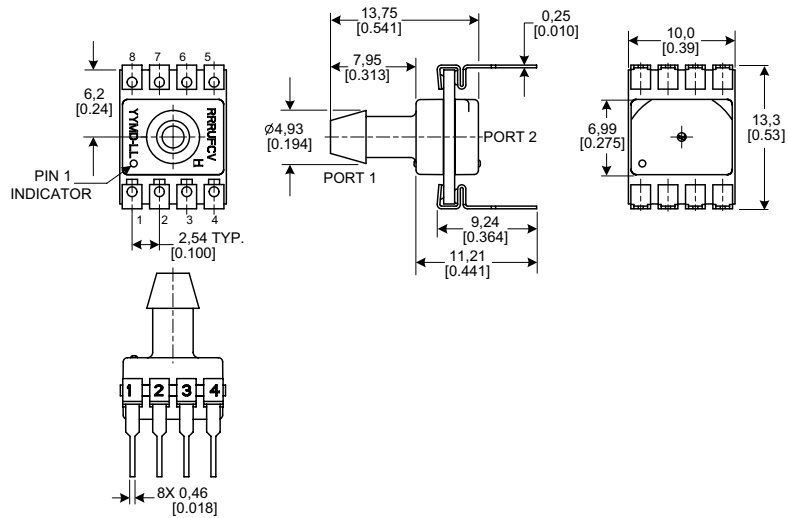

DIP LN: Single axial barbless port



Dimensional Drawings

DIP Packages

Figure 5. DIP Package Dimensional Drawings (continued)

Dimensions

DIP RN: Single radial barbed port

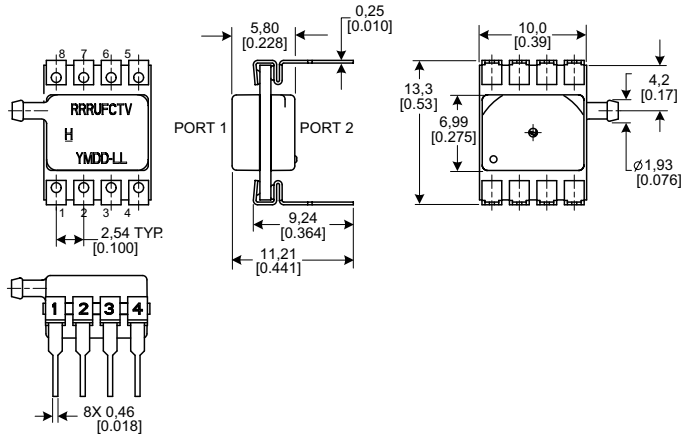
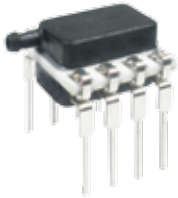

DIP RR: Dual radial barbed ports, same side

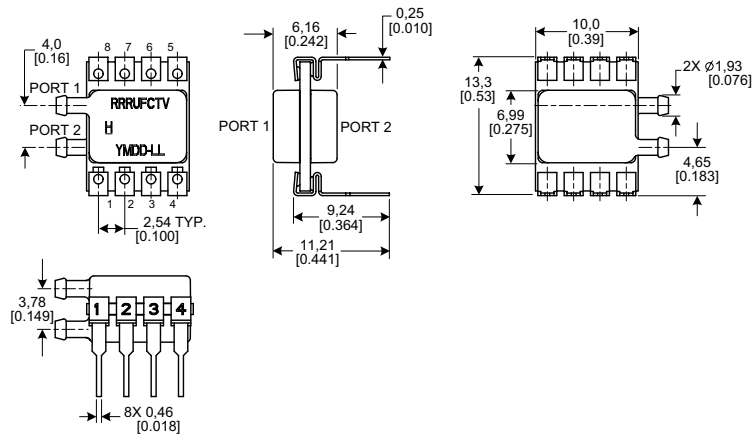
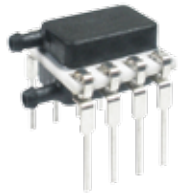

DIP DR: Dual radial barbed ports, opposite sides

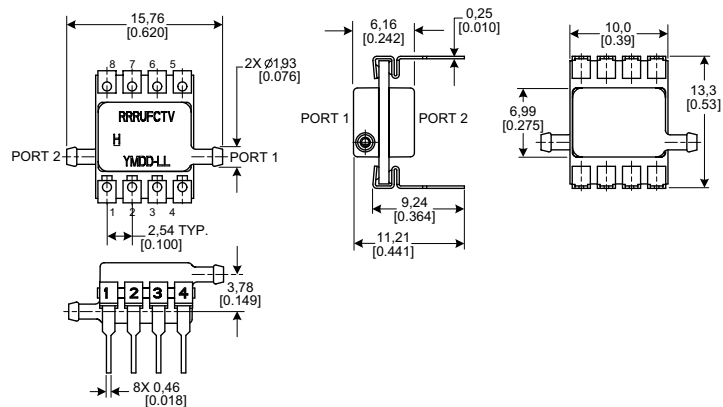

Dimensional Drawings

DIP and SMT Packages

Figure 5. DIP Package Dimensional Drawings (continued)

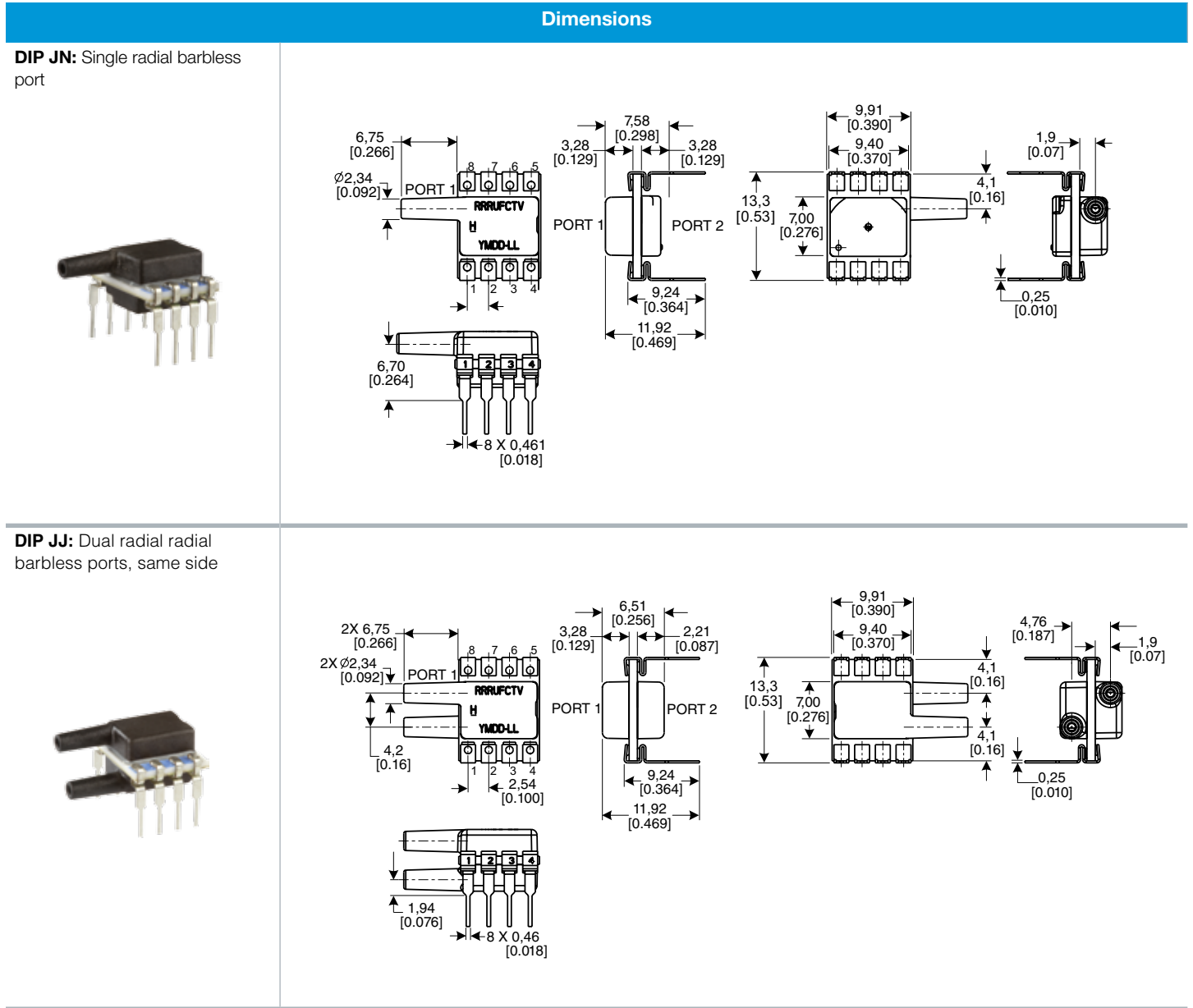
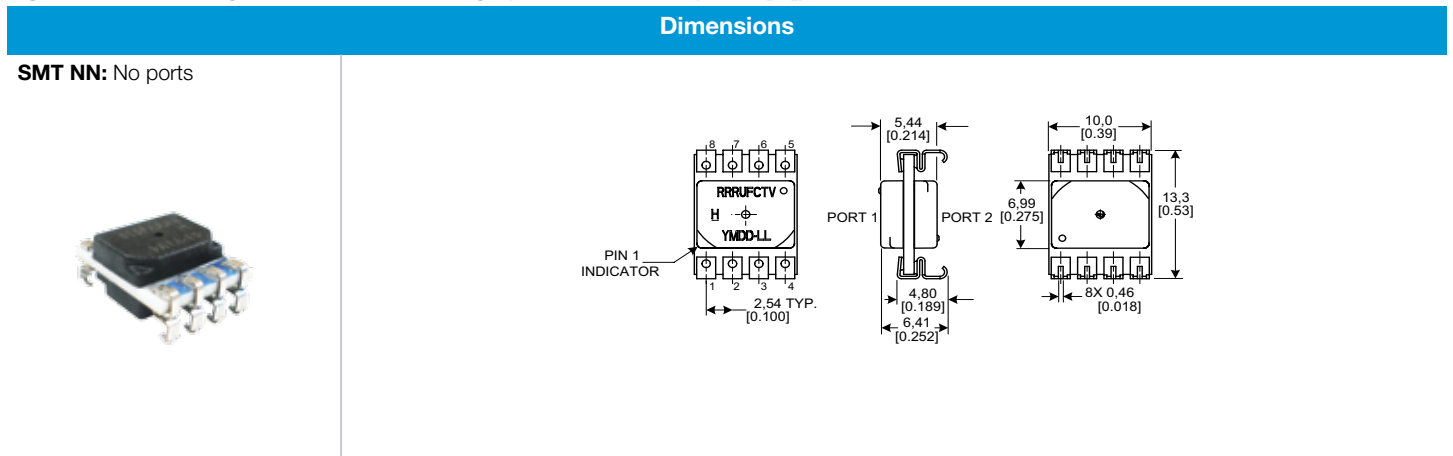

Figure 6. SMT Package Dimensional Drawings (For reference only: mm [in])



Dimensional Drawings

SMT Packages

Figure 6. SMT Package Dimensional Drawings (continued)

Dimensions

SMT AN: Single axial barbless port

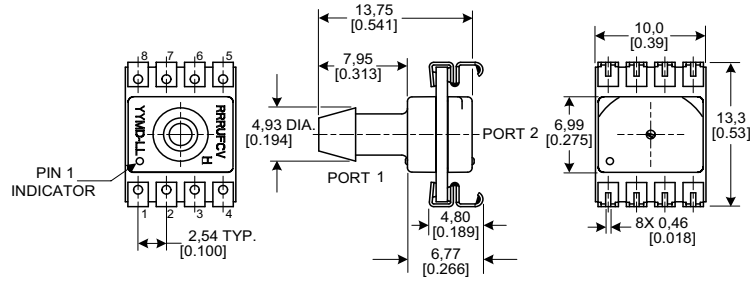

SMT LN: Single axial barbless port

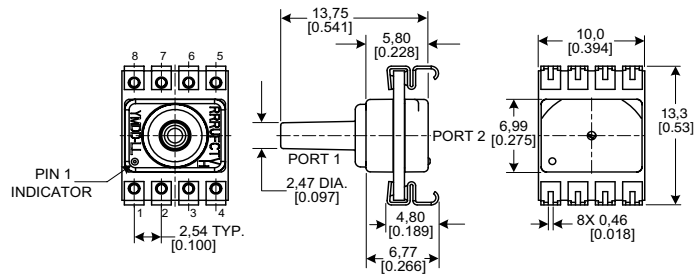

SMT RN: Single radial barbed port

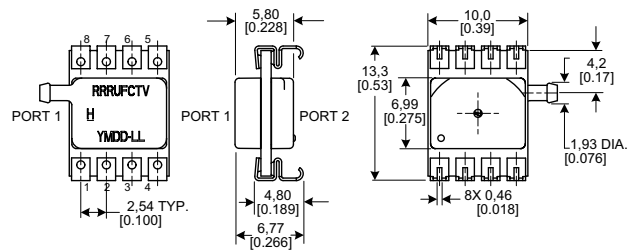

Dimensional Drawings

SMT Packages

Figure 6. SMT Package Dimensional Drawings (continued)

Dimensions

SMT RR: Dual radial barbed ports, same side



SMT DR: Dual radial barbed ports, opposite sides



SMT JN: Single radial barbless port



Dimensional Drawings

SMT and SIP Packages

Figure 6. SMT Package Dimensional Drawings (continued)



Figure 7. SIP Package Dimensional Drawings (For reference only: mm [in.]



Dimensional Drawings

SIP Packages

Figure 7. SIP Package Dimensional Drawings (continued)

Dimensions

SIP AN: Single axial barbed port

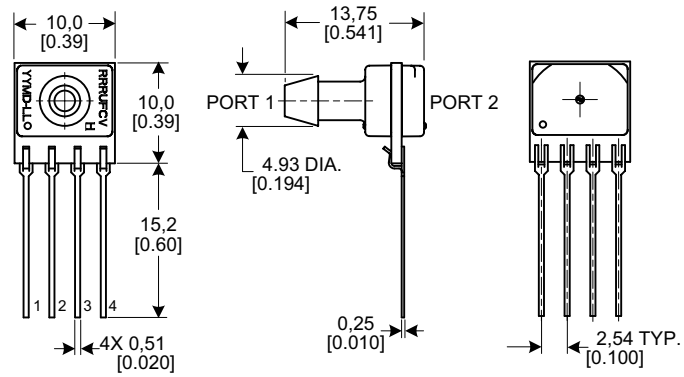

SIP LN: Single axial barbless port

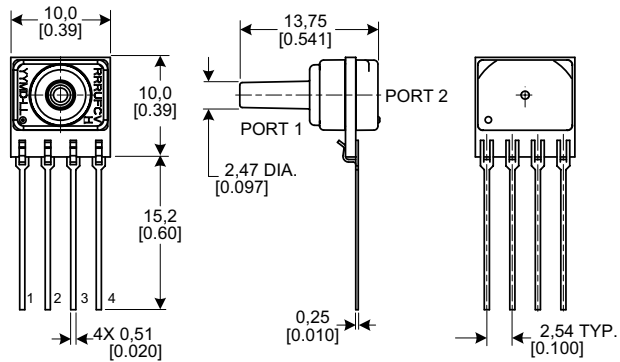

SIP FF: Fastener mount, dual axial barbed ports, opposite sides

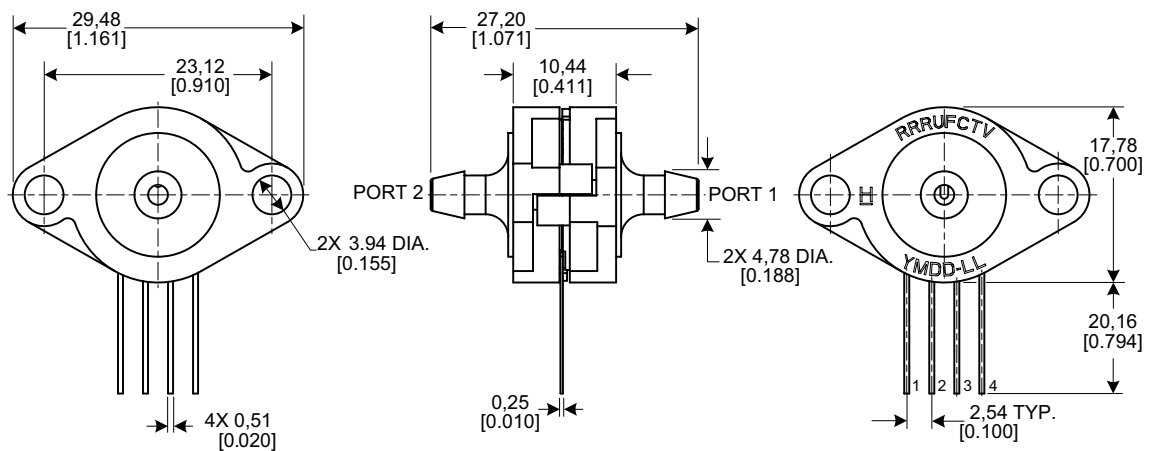

Dimensional Drawings

SIP Packages

Figure 7. SIP Package Dimensional Drawings (continued)

Dimensions

SIP FN: Fastener mount, single axial barbed port



SIP GN: Ribbed fastener mount, single axial barbed port

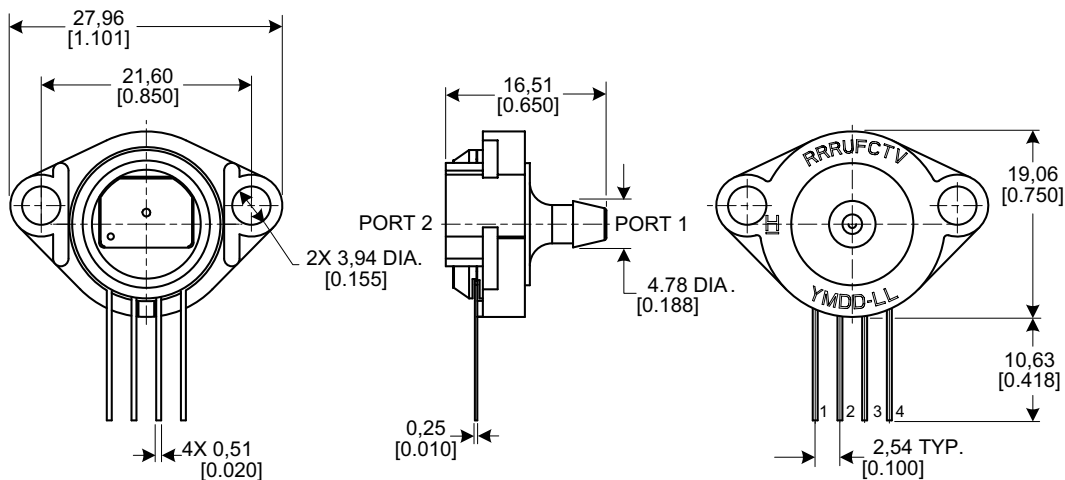

SIP NB: Fastener mount, dual axial ports, same side

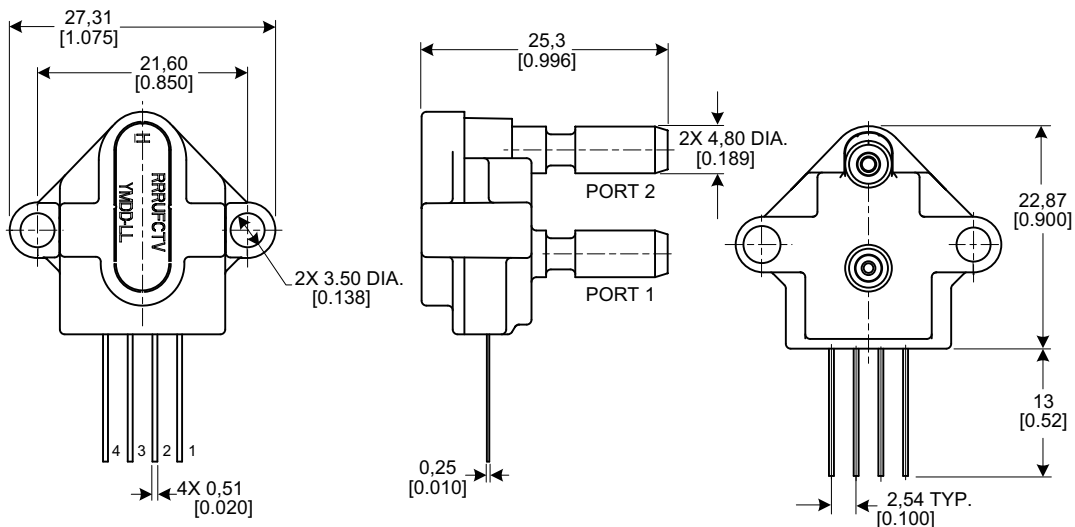

Dimensional Drawings

SIP Packages

Figure 7. SIP Package Dimensional Drawings (continued)

Dimensions

SIP RN: Single radial barbed port

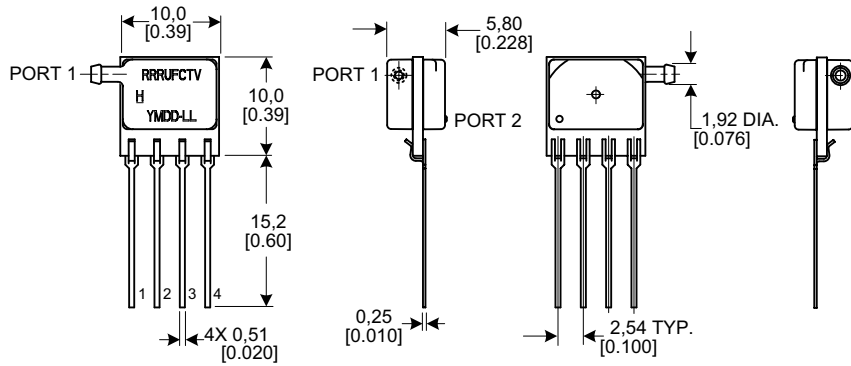

SIP RR: Dual radial barbed ports, same side

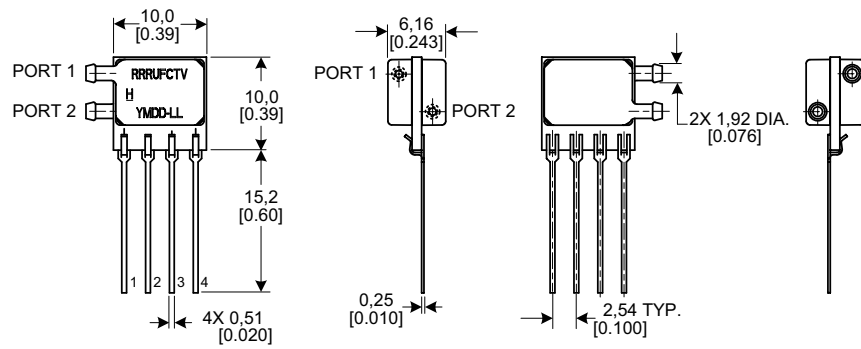

SIP DR: Dual radial barbed ports, opposite sides



Dimensional Drawings

SIP Packages

Figure 7. SIP Package Dimensional Drawings (continued)

Dimensions

SIP JN: Single radial barbless port

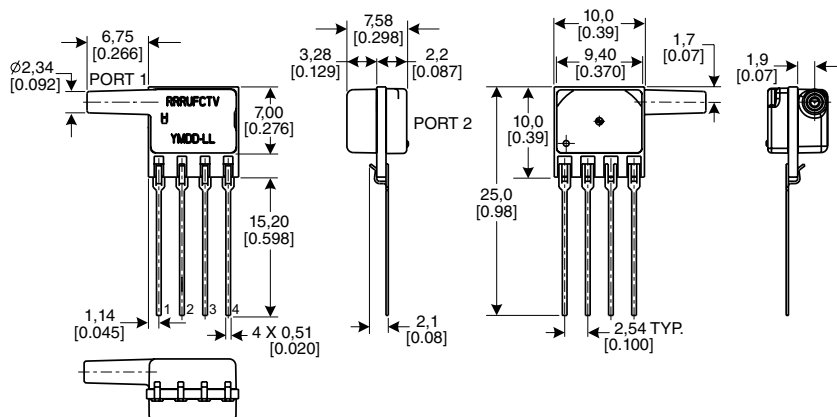

SIP JJ: Dual radial barbless ports, same side

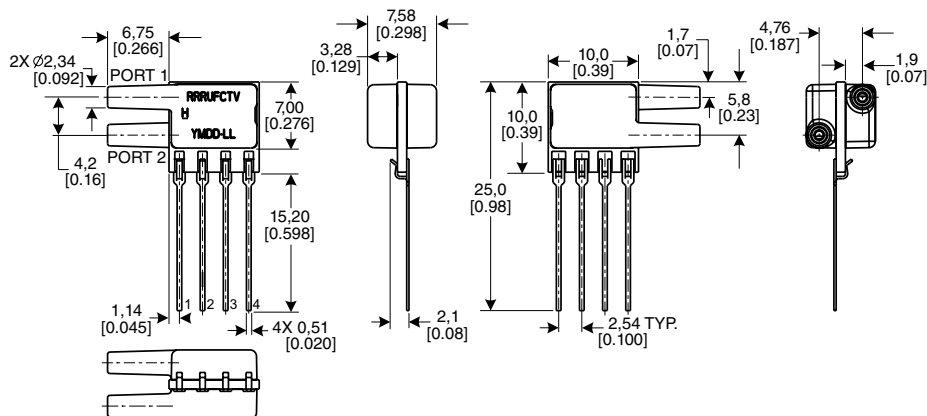
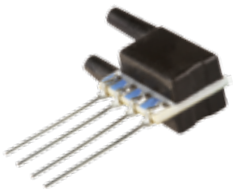



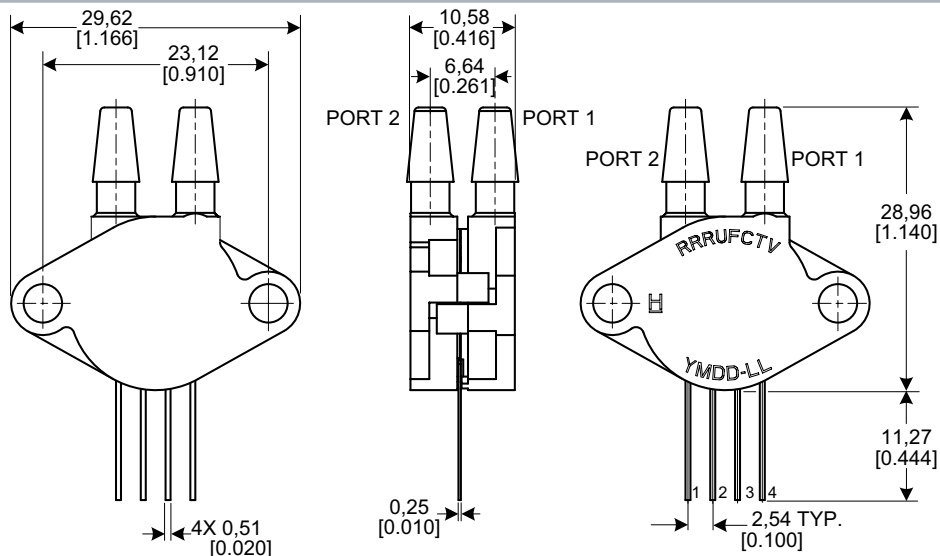

SIP HH: Fastener mount dual radial barbed ports, same side

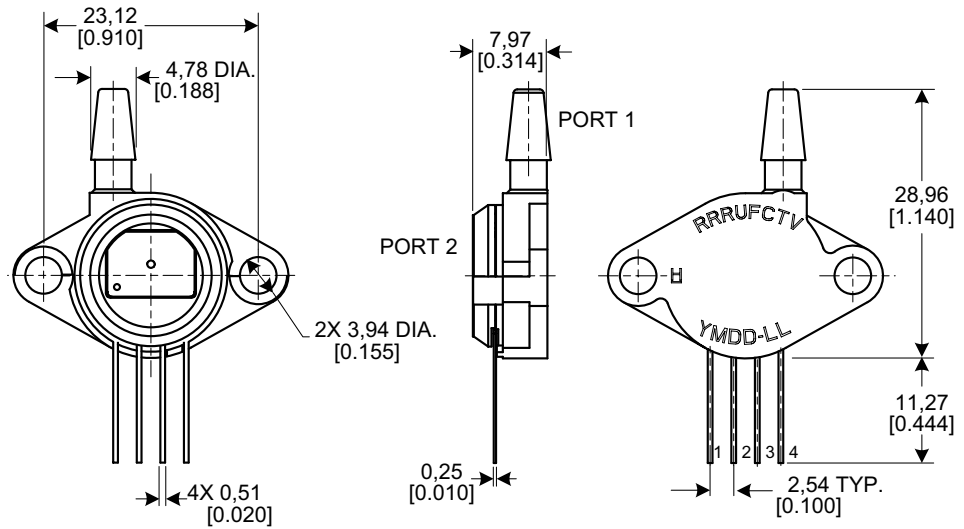

Dimensional Drawings

SIP Packages

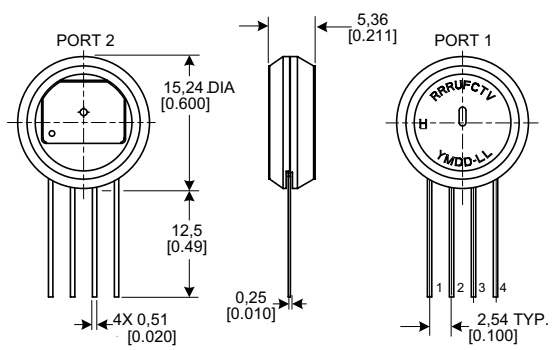
Figure 7. SIP Package Dimensional Drawings (continued)

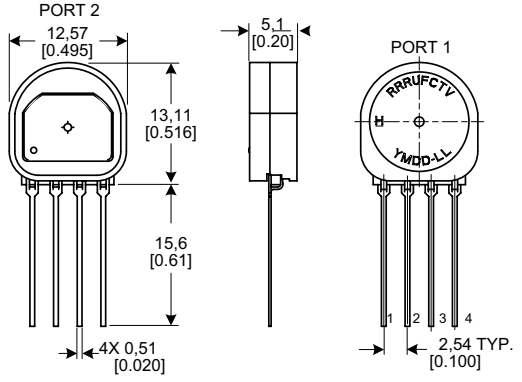
Dimensions	
<p>SIP HN: Fastener mount single radial barbed port</p> 	 <p>23,12 [0.910] 4,78 DIA. [0.188] 7,97 [0.314] PORT 1 PORT 2 2X 3,94 DIA. [0.155] 28,96 [1.140] 11,27 [0.444] 4X 0,51 [0.020] 0,25 [0.010] 2,54 TYP. [0.100]</p>
<p>SIP MN: Manifold mount, outer diameter seal</p> 	 <p>PORT 2 15,24 DIA. [0.600] 12,5 [0.49] 4X 0,51 [0.020] 5,36 [0.211] PORT 1 2,54 TYP. [0.100] 0,25 [0.010]</p>
<p>SIP SN: Manifold mount, inner diameter seal</p> 	 <p>PORT 2 12,57 [0.495] 13,11 [0.516] 15,6 [0.61] 4X 0,51 [0.020] 5,1 [0.20] PORT 1 2,54 TYP. [0.100]</p>

Pinout, PCB Pad Layout, Circuit Examples

Table 12. Pinout for DIP and SMT Packages

Output Type	Pin 1	Pin 2	Pin 3	Pin 4	Pin 5	Pin 6	Pin 7	Pin 8
analog	GND	V _{out+}	V _{supply}	V _{out-}	NC	NC	NC	NC

Table 13. Pinout for SIP Packages

Output Type	Pin 1	Pin 2	Pin 3	Pin 4
analog	GND	V _{out+}	V _{supply}	V _{out-}

Figure 8. Recommended PCB Pad Layouts

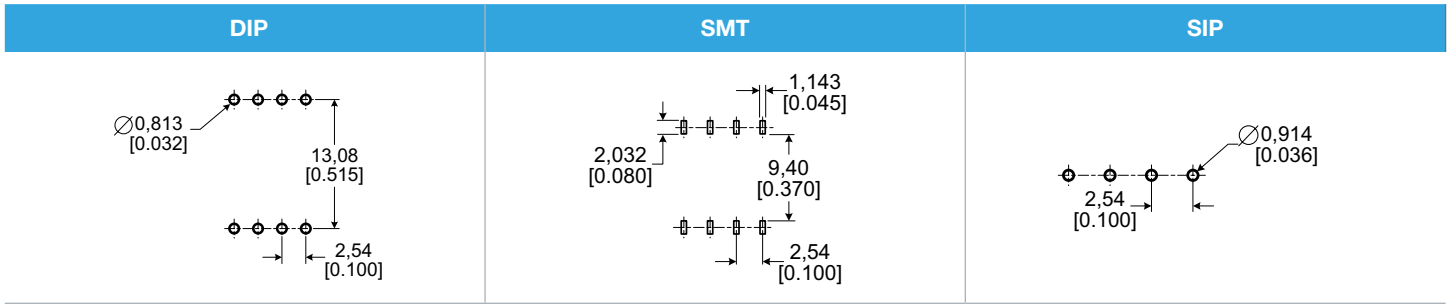
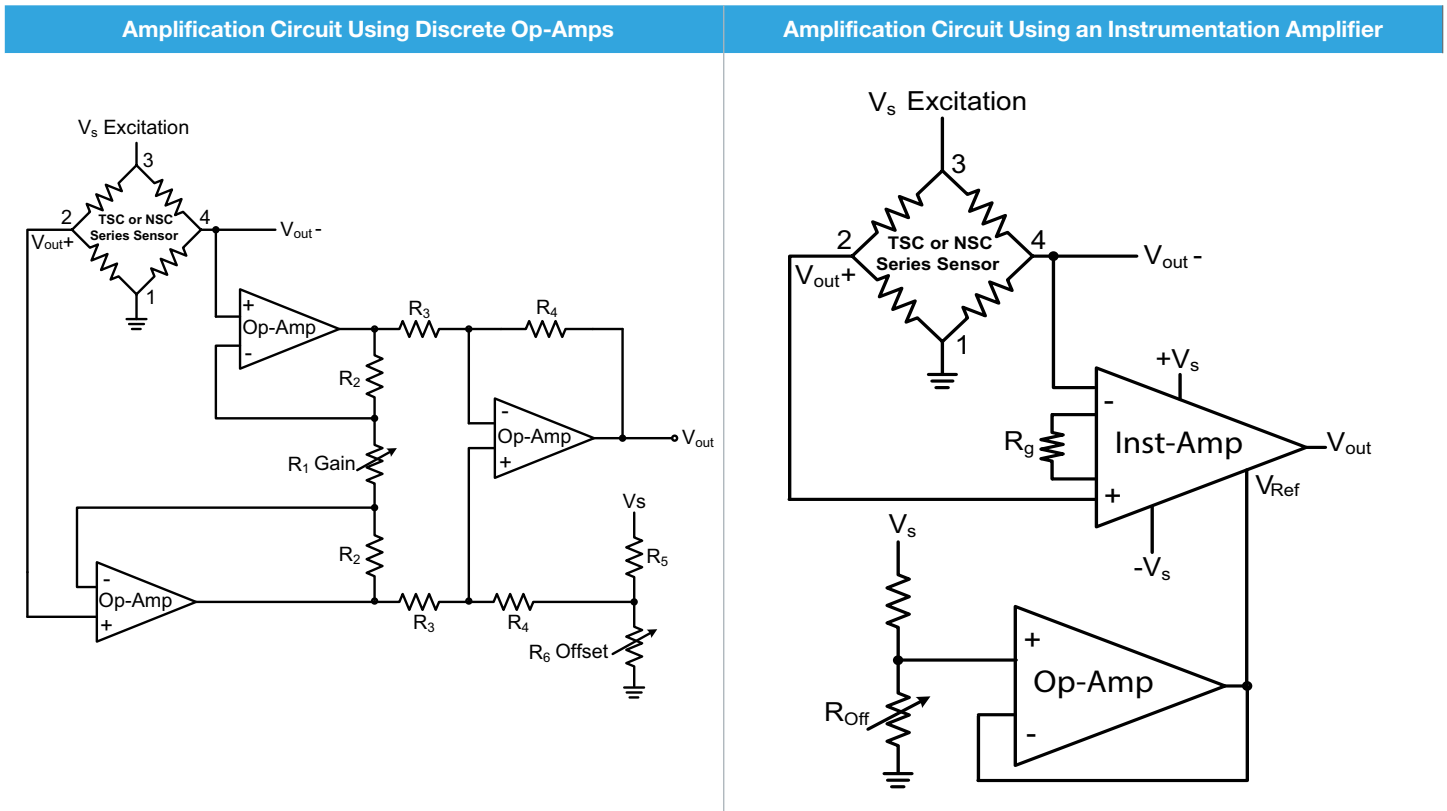

Figure 9. Circuit Examples



TruStability® Board Mount Pressure Sensors Portfolio Overview

Table 14. TruStability® Board Mount Pressure Sensors Portfolio Overview

Characteristic	Series			
	HSC	SSC	TSC	NSC
Package:				
DIP (Dual In-Line Pin)	✓	✓	✓	✓
SMT (Surface Mount Technology)	✓	✓	✓	✓
SIP (Single In-Line Pin)	✓	✓	✓	✓
Option:				
dry gases only, no diagnostics (all pressure ranges)	✓	✓	✓	✓
dry gases only, diagnostics on (all pressure ranges)	✓	✓	—	—
liquid media on port 1, no diagnostics (±60 mbar to ±10 bar ±6 kPa to ±1 MPa ±1 psi to ±150 psi)	✓	✓	✓	✓
liquid media on port 1, diagnostics on (±60 mbar to ±10 bar ±6 kPa to ±1 MPa ±1 psi to ±150 psi)	✓	✓	—	—
Pressure range:				
Absolute:				
1 bar to 10 bar 100 kPa to 1 MPa 15 psi to 150 psi	✓	✓	—	✓
Differential:				
±60 mbar to ±10 bar ±6 kPa to ±1 MPa ±1 psi to ±150 psi	✓	✓	✓	✓
±1.6 mbar to ±40 mbar ±160 Pa to ±4 kPa ±0.5 inH ₂ O to ±30 inH ₂ O	✓	✓	—	✓
Gage:				
60 mbar to 10 bar 6 kPa to 1 MPa 1 psi to 150 psi	✓	✓	✓	✓
2.5 mbar to 40 mbar 250 Pa to 4 kPa 1 inH ₂ O to 30 inH ₂ O	✓	✓	—	✓
Temperature compensated	✓	✓	✓	—
Amplified	✓	✓	—	—
Output type:				
analog	✓	✓	✓	✓
digital (SPI and I ² C)	✓	✓	—	—
Transfer function:				
10% to 90% of V _{supply}	✓	✓	—	—
Supply voltage:				
3.3 Vdc	✓	✓	—	—
5.0 Vdc	✓	✓	—	—
1.5 Vdc to 12.0 Vdc (for pressure ranges ≥60 mbar 6 kPa 1 psi)	—	—	✓	✓
2.7 Vdc to 6.5 Vdc (for pressure ranges ≤40 mbar 4 kPa 20 inH ₂ O)	—	—	—	✓
Accuracy ≤ 0.25 %FSS BFSL	✓	✓	✓	✓
Compensated temperature range:				
-20 °C to 85 °C [-4 °F to 185 °F]	—	✓	—	—
0 °C to 85 °C [32 °F to 185 °F]	—	—	✓	—
0 °C to 50 °C [32 °F to 122 °F]	✓	—	—	—
Operating temperature range:				
-20 °C to 85 °C [-4 °F to 185 °F]	✓	—	—	—
-40 °C to 85 °C [-40 °F to 185 °F]	—	✓	✓	✓
Total Error Band:¹				
down to ±1% Full Scale Span max.	✓	—	—	—
down to ±2% Full Scale Span max.	—	✓	—	—

¹Applies only to pressure ranges ≥16 mbar | 1.6 kPa | 5 inH₂O. For complete Total Error Band information, please see the specification tables in the HSC Series and the SSC Series published datasheets.

ADDITIONAL INFORMATION

The following associated literature is available at sensing.honeywell.com:

- Board Mount Pressure Sensors Line Guide
- Airflow, Force, and Pressure Sensors Product Range Guide
- Product Installation Instructions
- Product Nomenclature Tree and Order Guide
- Selection Guides
- Application-specific Information

⚠ WARNING **PERSONAL INJURY**

DO NOT USE these products as safety or emergency stop devices or in any other application where failure of the product could result in personal injury.

Failure to comply with these instructions could result in death or serious injury.

⚠ WARNING **MISUSE OF DOCUMENTATION**

- The information presented in this product sheet is for reference only. Do not use this document as a product installation guide.
- Complete installation, operation, and maintenance information is provided in the instructions supplied with each product.

Failure to comply with these instructions could result in death or serious injury.

Find out more

Honeywell serves its customers through a worldwide network of sales offices, representatives and distributors. For application assistance, current specifications, pricing or name of the nearest Authorized Distributor, contact your local sales office.

To learn more about Honeywell's sensing and control products, call **+1-815-235-6847** or **1-800-537-6945**, visit **sensing.honeywell.com**, or e-mail inquiries to **info.sc@honeywell.com**

Sensing and Control
Honeywell
1985 Douglas Drive North
Golden Valley, MN 55422
honeywell.com

WARRANTY/REMEDY

Honeywell warrants goods of its manufacture as being free of defective materials and faulty workmanship. Honeywell's standard product warranty applies unless agreed to otherwise by Honeywell in writing; please refer to your order acknowledgement or consult your local sales office for specific warranty details. If warranted goods are returned to Honeywell during the period of coverage, Honeywell will repair or replace, at its option, without charge those items it finds defective. **The foregoing is buyer's sole remedy and is in lieu of all other warranties, expressed or implied, including those of merchantability and fitness for a particular purpose. In no event shall Honeywell be liable for consequential, special, or indirect damages.**

While we provide application assistance personally, through our literature and the Honeywell website, it is up to the customer to determine the suitability of the product in the application.

Specifications may change without notice. The information we supply is believed to be accurate and reliable as of this printing. However, we assume no responsibility for its use.

Honeywell