

1 2 3 4 5 6

A

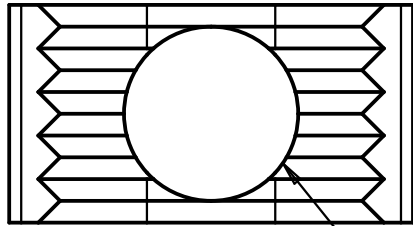

Location of ejector pin

B

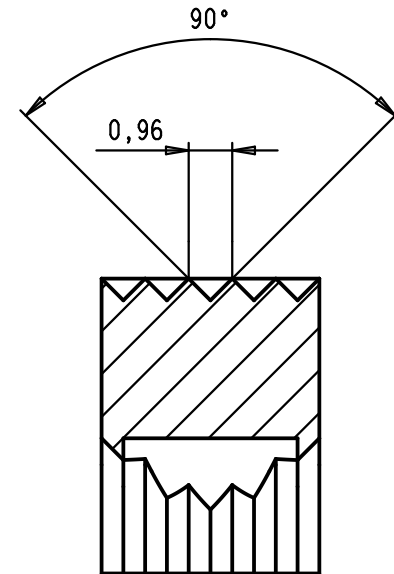
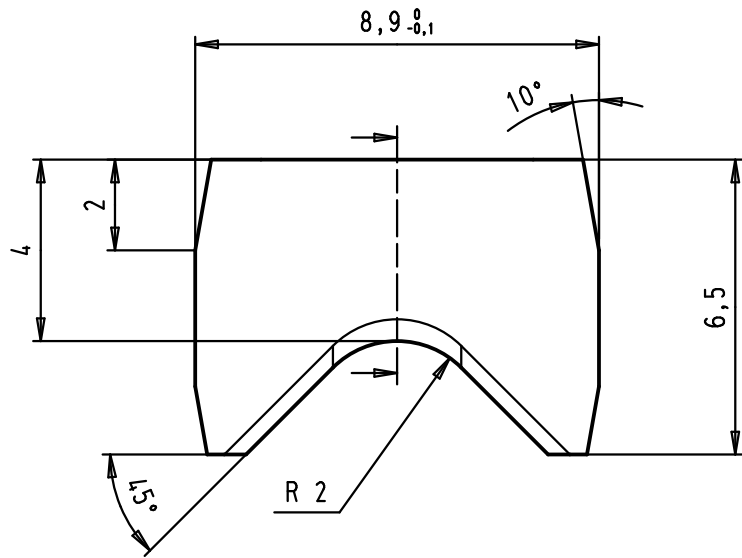



C

Insert to be used for hoods with part numbers 09 67 OXX 0425 and 09 67 OXX 0435 (XX = 09 or 15 poles)

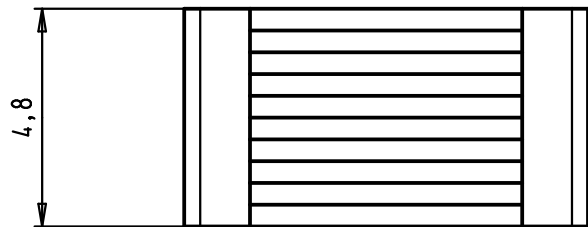
D



				Dot.	Name	 All Dim. in mm Orig. Size DIN A 4	Metallized insert for D-Sub hoods 9 to 15 poles	Maßstab/ Scale 6:1
			Detail.	09/10/09	PK			
			Insp.					
			Stand.					
EC00871	19/10/09	PK	HARTING EURL F-95972 Paris				TB 09 67 002 9103	Blatt/ Page 1 / 1
Mod.	Dot.	Name					Sub.	