

Sales Outline Drawing

Specifications:

Sensitivity Range	-42 ± 3 dB $R_L = 2.2\text{ k}\Omega$ $V_{cc} = 2.0\text{v}$ (1 kHz 0 dB = 1 v/Pa)
Impedance	Max. 2.2k Ω 1 kHz ($R_L = 2.2\text{ k}\Omega$)
Frequency	20 - 16000 Hz
Current Consumption	Max 0.5 mA
Operating Voltage Range	1.0 – 10 V
Max SPL (dB)	120 dB
S/N Ration	More than 58 dB
Sensitivity Reduction	2.0 –1.5V Variation less than 3 dB
Storage Condition	-45 ~ +75°C; R.H. < 90%
Operating Condition	-10 ~ +45°C; R.H. < 90%
Weight (g)	0.3
Options	For other options contact factory

Dimensions: (units: mm)

ROHS Compliant

Filter

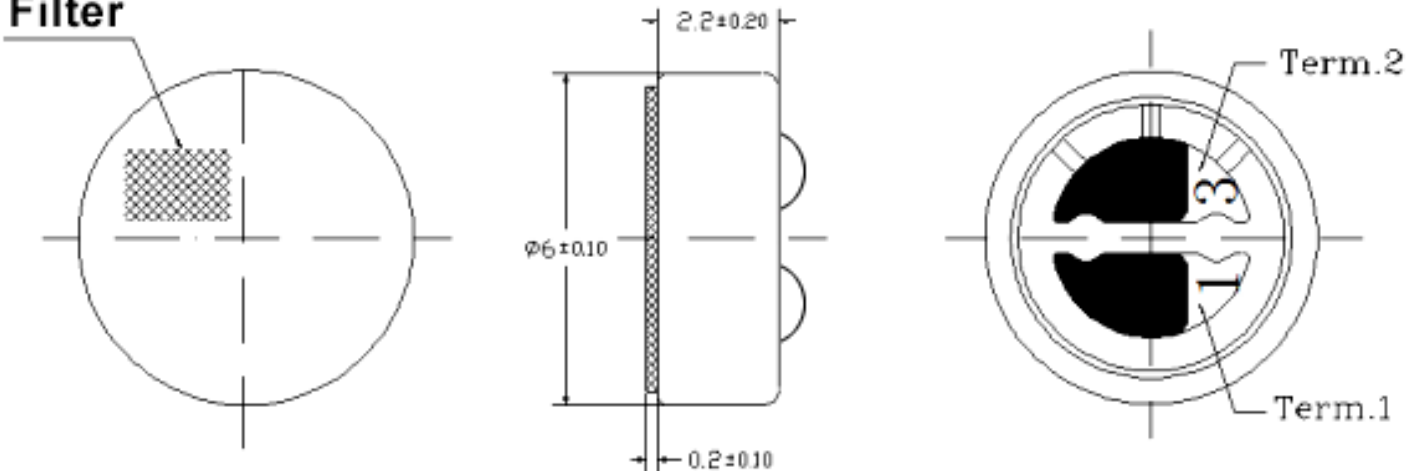

Schematic Diagram:

