



ON Semiconductor

NCL30288LED1GEVB

18 W High Power Factor LED Driver

Evaluation Board User Manual

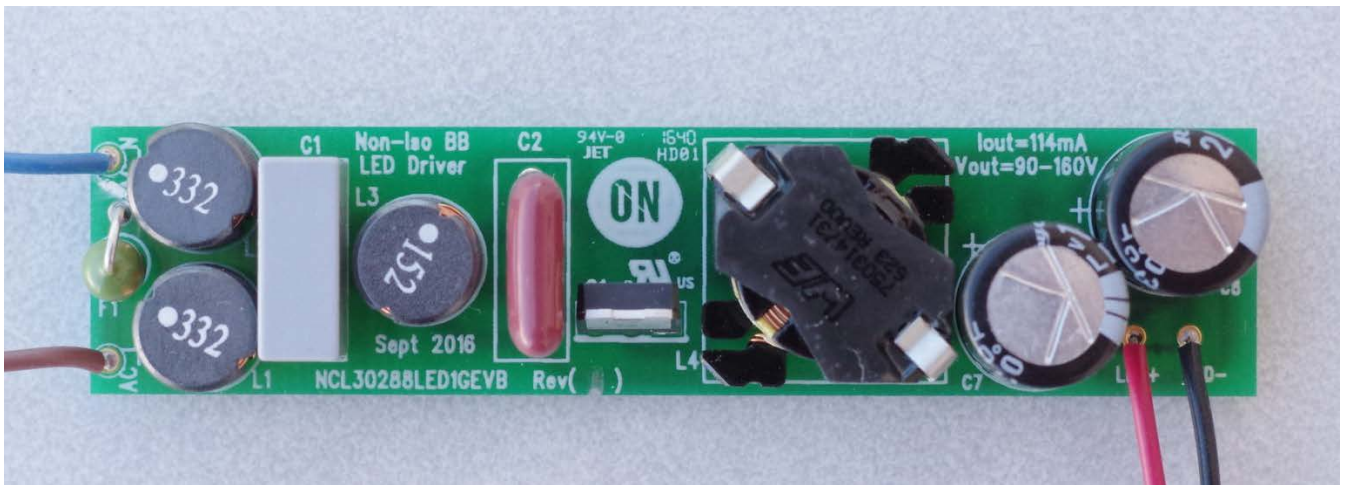

Overview

This manual covers the specification, theory of operation, testing and construction of the NCL30288LED1GEVB demonstration board. The NCL30288 board demonstrates an 18 W high PF buck boost LED driver in a typical T8 outline.

Specifications

Input voltage (Class 2 Input, no ground)	100, 120, 230, 277 V ac	
Line Frequency	50 Hz/60 Hz	
Power Factor (100% Load)	0.95	Min
THD (100% Load)	10%	Max
Output Voltage Range	90 – 160 V dc	
Output Current	114 mA dc	+/- 2 %
Efficiency	92 %	Typ.
Start Up Time	< 500 msec	Typ.
EMI (conducted)	Class B	FCC/ CISPR

As illustrated, the key features of this demo board include:

- Wide Mains
- Low THD across line and load
- High Power Factor across wide line and load
- Integrated Auto recovery Fault Protection
 - Over Current
 - Output and Vcc Over Voltage
 - Integral Over Temperature Protection

Theory of Operation

Power Stage

The power stage for the demo board is a non-isolated buck-boost based. The controller has a built in control algorithm that is specific to the flyback transfer function. Specifically:

$$\frac{V_{out}}{V_{in}} = \frac{Duty}{(1-Duty)}$$

This is applicable to flyback, buck-boost, and SEPIC converters. The control is very similar to the control of the NCL30080-83 with the addition of a power factor correction control loop. The controller has a built in hardware algorithm that relates the output current to a reference on the primary side.

$$I_{out} = \frac{V_{ref} \times N_{ps}}{2 \times R_{sense}}$$
$$N_{ps} = \frac{N_{pri}}{N_{sec}}$$

Where N_{pri} = Primary Turns and N_{sec} = Secondary Turns

We can now find R_{sense} for a given output current.

$$R_{sense} = \frac{V_{ref} \times N_{ps}}{2 \times I_{out}}$$

Line Feedforward

The controller is designed to precisely regulate output current but input line voltage variations do have an impact. R7 sets the line feedforward and compensates for power stage delay times by reducing the current threshold as the line voltage increases. R7 is also used by the shorted pin detection. At start up the controller puts out a current to check for a shorted pin. If the resistance presented on the CS/ZCD pin is too low, the controller will not start because it will

detect a shorted pin. Therefore R7 is required to make the controller operate properly. In practice, R7 should be greater than 250 Ω .

Voltage Sense

The voltage sense pin has several functions:

1. Basis for the reference of the PFC control loop
2. Line Range detection

The reference scaling is automatically controller inside the controller. While the voltage on Vs is not critical for the PFC loop control, it is important for the range detection. Generally the voltage on Vs should be 3.5 V peak at the highest input voltage of interest. The voltage on Vs determines which valley the power stage will operate in. At low line and maximum load, the power stage operates in the first valley (standard CrM operation). At the higher line range, the power stage moves to the second valley to lower the switching frequency while retaining the advantage of CrM soft switching.

The range detection operation is evident if the input voltage is increased gradually between the range of 135Vac and 180Vac for typical resistor divider ratios. A momentary interruption can be seen on the output as the controller changes operating range. This is a normal response to the range change.

Auxiliary Winding

The auxiliary winding has 3 functions:

1. CrM timing
2. Vcc Power
3. Output voltage sense

CrM Timing

During the off time, the voltage on the transformer/inductor forward biases D2, D3, and D4. When the current in the magnetic reaches zero, the winding voltage will collapse to zero. This voltage collapse



ON Semiconductor

triggers a comparator on the CS/ZCD pin to start a new switching cycle. The ZCD pin also counts rings on the auxiliary winding for second valley operation in high range mode. A failure of the CS/ZCD pin to reach a certain threshold also indicates a shorted output condition, activating fault mode operation.

Vcc Power

The auxiliary winding forward biases D3 to provide power for the controller. This arrangement is called a “bootstrap”. Initially the C6 is charged through R8 - R11. When the voltage on C6 reaches the startup threshold, the controller starts switching and providing power to the output circuit and the controller. C6 discharges as the controller draws current. As the output voltage rises, the auxiliary winding starts to provide the energy needed to power the controller. Ideally, this happens before C6 discharges to the under voltage threshold where the controller stops operating allowing C6 to recharge once again. The size of the output capacitor will have a large effect on the startup time. Since the LED driver is a current source, the rise of output voltage is directly dependent on the size of the output capacitor.

There are tradeoffs in the selection of C6, C7, and C8. A low output ripple will require a large C7, C8 value. This requires that C6 be large enough to support Vcc power to the controller while the main output capacitance is charging up. A large value of C6 requires that R8 - R11 be lower in value to allow a fast enough startup time. Smaller values of R8 - R11 have higher static power dissipation which lowers efficiency of the driver. Multiple resistors are used due to voltage and power stress during high input line operation.

Output Voltage Sense

The auxiliary winding voltage is proportional to the output voltage by the turns ratio of the output winding and the auxiliary winding. The controller has an overvoltage limit on the Vcc pin at about 25.5 V minimum. Above that threshold, the controller will stop operation and enter overvoltage fault mode such as when an open LED string occurs.

In cases where the output has a lot of ripple current and the LED has high dynamic resistance, the peak output voltage can be much higher than the average output voltage. The auxiliary winding will charge C6 to the peak of the output voltage which may trigger the OVP sooner than expected so in this case the peak voltage of the LED string is critical.

During fault mode, the bias current of the controller is significantly reduced. If the start resistors R8 - R11 are sufficiently low resistance due to faster startup times, they will deliver excessive current to Vcc under high line conditions. This can initiate the OVP function on the Vcc pin. Once activated, the controller latches off because Vcc is continuously forced above OVP levels. Therefore, if faster startup is required, it may be necessary to add zener diode D5 across Vcc preventing OVP activation. This diode must not clamp below the maximum start voltage of the controller. A 22 volt zener is suggested to meet these requirements. Including resistor R12 in series with zener D5 allows the higher current capacity of the bias winding to initiate an OVP if necessary.

CS/ZCD Pin

The CS/ZCD pin has the dual role of providing current monitoring of the power switch during the on-time and voltage monitoring the transformer during the off-time.

The control algorithm relies on a signal proportional to input switching current during the on-time to control power delivered to the output. A blanking function removes spurious signals relating to turning on the main power switch. Additionally, a line feed-forward signal is impressed on the resistor coupling the CS/ZCD pin to the current sense resistor compensating for input line variation.

Two excess current functions are also provided by the CS/ZCD pin. A maximum peak current limit correlating to 1.00 volt will turn off the power switch protecting against excessive current. A separate circuit detects a shorted winding or output diode for added protection.

Voltage sensing during the off-time provides zero current detection essential for proper Critical Conduction Mode operation. A minimum voltage is monitored to ensure there are no faults on the output. When the voltage on the winding subsequently reduces to a low level indicating demagnetization, an internal comparator signals the beginning of the next switching cycle.

A separate comparator monitors the CS/ZCD winding to detect excessive output voltage. The threshold is established by a divider consisting of R6, D2, and R7. (The voltage drop across R13 and R14 is negligible during the off-time and can be ignored.) The level must be scaled for the turns ratio of the magnetic to represent the output voltage. A blanking function reduces the effect of switching noise affecting this over voltage protection feature.

Circuit Modifications

Output Current

As previously mentioned, the output current is a function of the internal reference voltage and the turns ratio of the transformer. For this buck-boost implementation, the turns ratio is simply '1'. The nominal value for the reference voltage is 0.2 volts. Therefore, the output current can be approximated by the formula below. Empirical adjustments may be required due to feedforward function.

$$R_{\text{sense}} = \frac{0.2}{2 \times I_{\text{out}}}$$

The output current is set by the parallel equivalent value of R13 and R14. Typically R14 is selected slightly above the target value and R13 is chosen to provide a combined value very close to the target. Since the magnetic is designed for 18 W, it is possible to increase the current while reducing the maximum LED forward voltage within limits. Changes of current of $\pm 10\%$ are within the existing EMI

filter design and magnetic, changes of more than 10% may require further adjustments to the transformer or EMI filter.

Thermal Protection

Basic thermal protection is possible by adding a Positive Temperature Coefficient (PTC) thermistor in series with the CS path resistor R7. When the PTC is heated and reaches its transition point, the added resistance effectively rescales the ZCD OVP threshold forcing the converter to shut down and activate the restart timer. When elapsed, the timer will restart the converter. ON/OFF cycling will continue until the PTC cools.

The value of R7 should be reduced by the nominal resistance of the PTC to preserve the over voltage and feedforward functions. Note that the exact thermal shutdown temperature is not well defined due to tolerance of the PTC and will also be a function of output voltage. It is suggested that this PTC thermal protection could be used as a low-cost failsafe for certain applications. Note the PTC thermistor should be located close to the NCL30288 to avoid noise pickup in the sensitive current sense function.

A typical PTC device is the PRF18Bx471QB1RB manufactured by Murata Manufacturing. The 'x' in the part number determines the characteristic temperature where thermal protection will begin. For example, the 'E' device transitions at about 85°C. The actual performance in the circuit will vary depending on tolerance, the value of R7, and the prevailing temperature of the PCB. Empirical testing covering all operating conditions is recommended.



Schematic

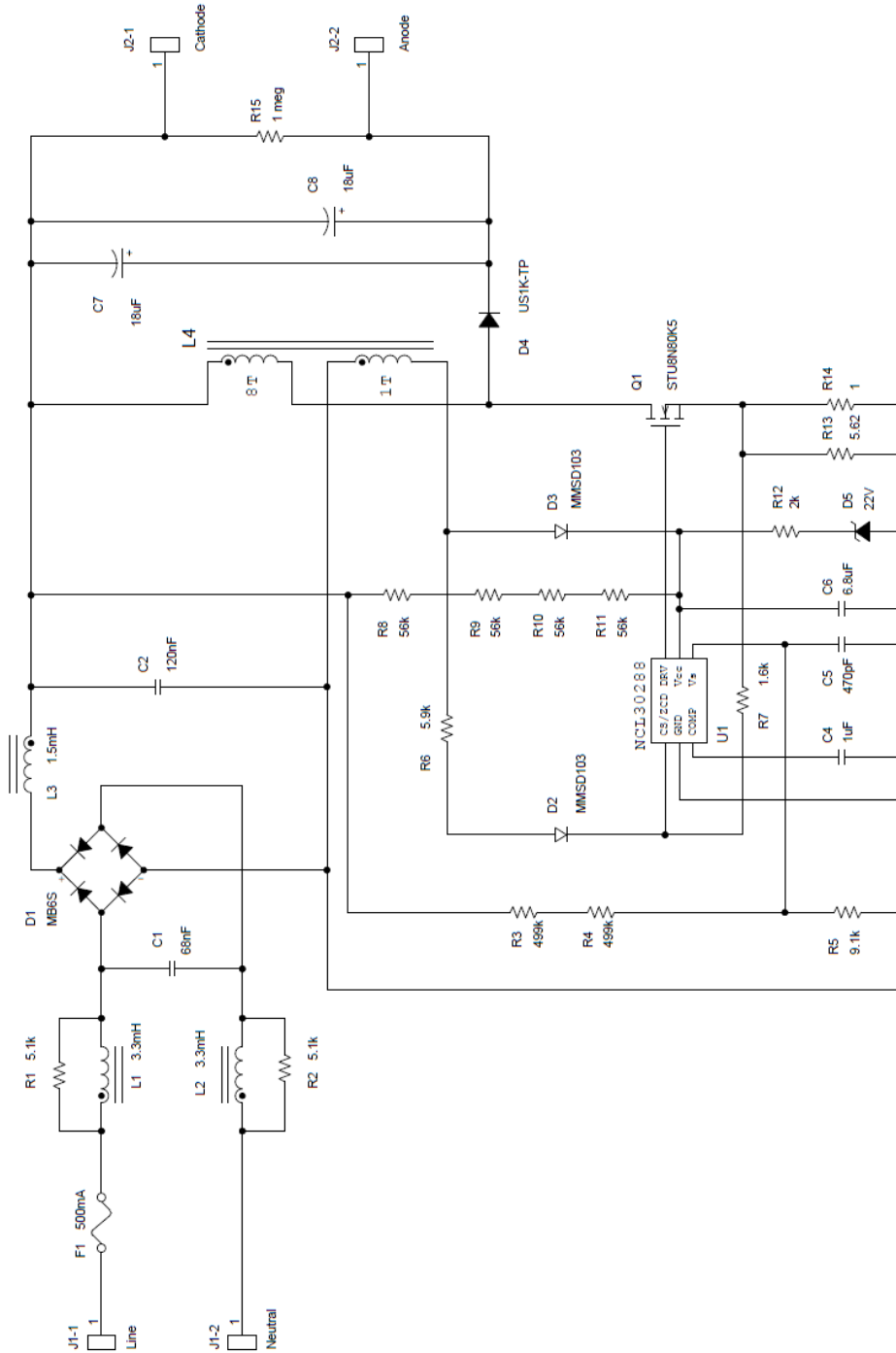

Figure 1. Main Schematic



Bill of Material

Designator	Quantity	Description	Value	Footprint	Manufacturer	Part Number
C1	1	Film Capacitor	68nF 310V	12M5X5_LS10	Vishay	BFC233820683
C2	1	Film Capacitor	120nF 450V	12.6MX4.6M_LS10	Panasonic	ECW-FD2W124KQ
C3	1	Not Fitted	-	0603		
C4	1	Ceramic Capacitor	1uF 50V	0603	TDK	C1608X6S1H105K080AC
C5	1	Ceramic Capacitor	470pF 50V	0603	TDK	C1608C0G1H471K080AA
C6	1	Ceramic Capacitor	6.8uF 35V	1206	TDK	C3216X7R1V685K160AC
C7, C8	2	Electrolytic Capacitor	18uF 200V	10MX12M5_LS5	Rubycon	200LLE18MEFC10X12.5
D1	1	Diode Bridge	0.5A 600V	MBS-1	Micro Commercial	MB6S-TP
D2, D3	2	Diode	200mA 250V	SOD-123	ON Semiconductor	MMSD103T1G
D4	1	Diode	1A 800V	SMA	Micro Commercial	US1K-TP
D5	1	Zener Diode	22V	SOD-123	ON Semiconductor	MMSZ4708T1G
F1	1	Fuse	500mA 250V	Hairpin_LS250	Littelfuse	0263.500WRT1L
L1, L2	2	Inductor	3.3mH	Radial_LS5	Würth	744772332
L3	1	Inductor	1.5mH	Radial_LS5	Würth	744772152
L4	1	Inductor	1.25mH 8:1	RM6_4P	Würth	750314731
Q1	1	MOSFET	6A 800V	IPAK	STMicro	STU8N80K5
R1, R2	2	Resistor	5.1k	1206	ANY	
R3, R4	2	Resistor	499k	1206	ANY	
R5	1	Resistor	9.1k	0603	ANY	
R6	1	Resistor	5.9k	1206	ANY	
R7	1	Resistor	1.6k	0603	ANY	
R8, R9, R10, R11	4	Resistor	56k	1206	ANY	
R12	1	Resistor	2k	0603	ANY	
R13	1	Resistor	5.62	1206	ANY	
R14	1	Resistor	1	1206	ANY	
R15	1	Resistor	1 meg	1206	ANY	
U1	1	Controller		TSOP-6	ON Semiconductor	NCL30288BSNT1G
W1	6"	Wire	Wire, Red	24 AWG	ANY	
W2	6"	Wire	Wire, Black	24 AWG	ANY	
W3,4	12"	Wire	Wire, White	24 AWG	ANY	

Gerber Views

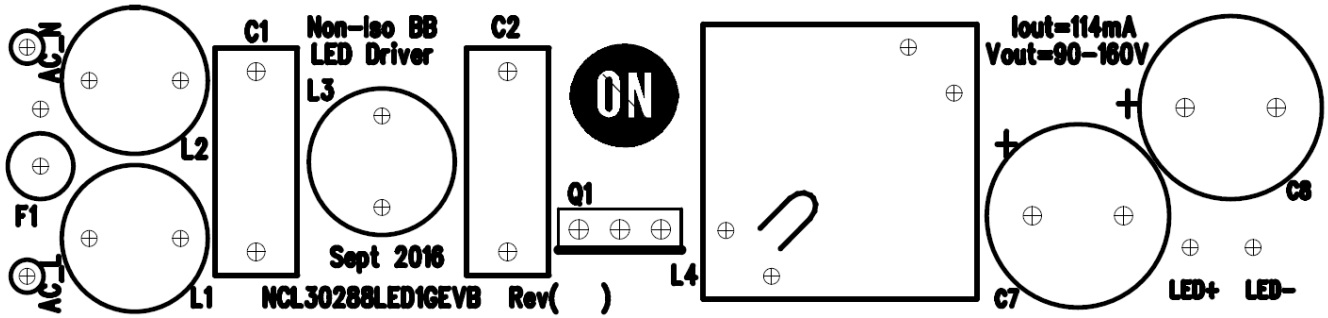

Figure 2. Top Silkscreen

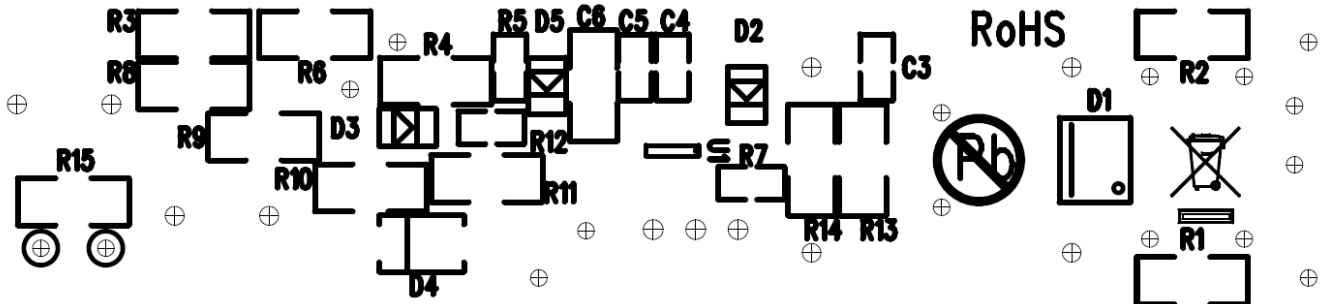

Figure 3. Bottom Silkscreen



ON Semiconductor

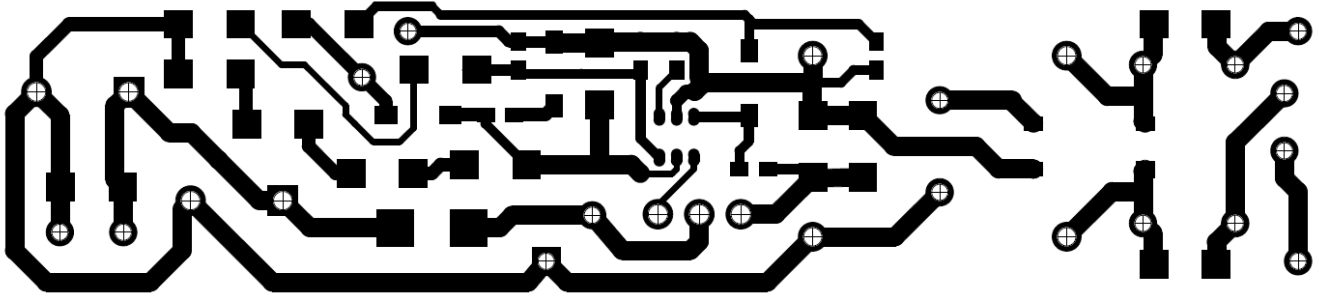
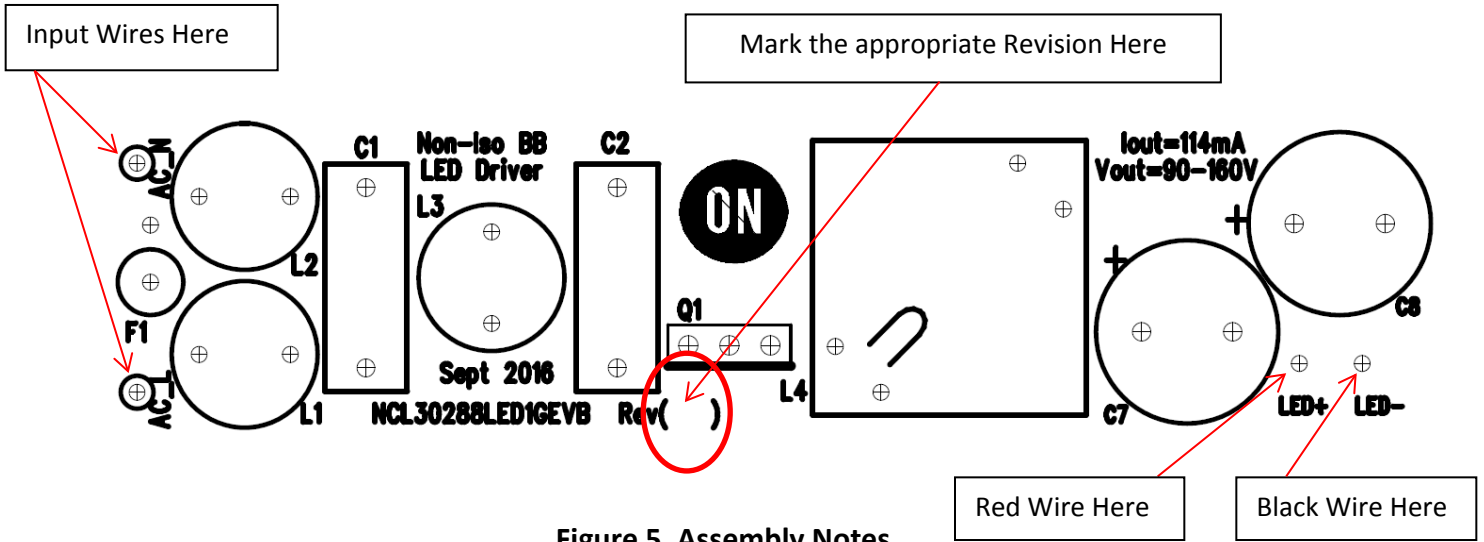

Figure 4. Bottom Copper



ON Semiconductor



1. Strip and tin lead wires to 6" ± 0.5" 4 Places. Red for LED+, Black for LED-, White for AC_L and AC_N

Notch in top of bobbin oriented as shown

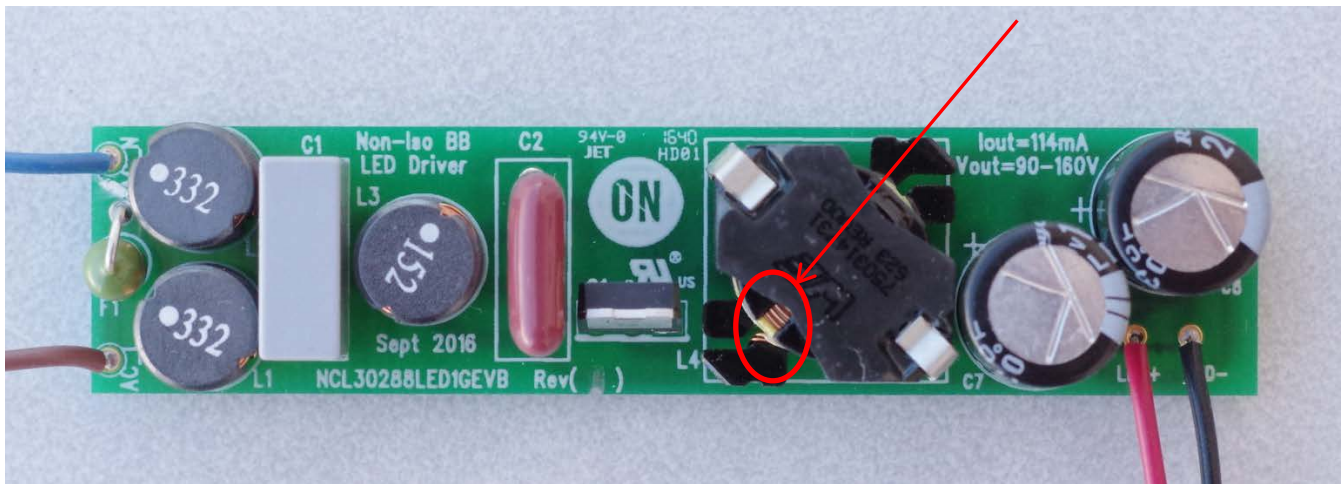



Circuit Board Fabrication Notes

1. Fabricate per IPC-6011 and IPC6012. Inspect to IPA-A-600 Class 2 or updated standard.
2. Printed Circuit Board is defined by files listed in fileset.
3. Modification to copper within the PCB outline is not allowed without permission, except where noted otherwise. The manufacturer may make adjustments to compensate for manufacturing process, but the final PCB is required to reflect the associated gerber file design ± 0.001 in. for etched features within the PCB outline.
4. Material in accordance with IPC-4101/21, FR4, Tg 125° C min.
5. Layer to layer registration shall not exceed ± 0.004 in.
6. External finished copper conductor thickness shall be 0.0026 in. min. (ie 2oz)
7. Copper plating thickness for through holes shall be 0.0013 in. min. (ie 1oz)
8. All holes sizes are finished hole size.
9. Finished PCB thickness 0.031 in.
10. All un-dimensioned holes to be drilled using the NC drill data.
11. Size tolerance of plated holes: ± 0.003 in. : non-plated holes ± 0.002 in.
12. All holes shall be +/- 0.003 in. of their true position U.D.S.
13. Construction to be SMOBC, using liquid photo image (LPI) solder mask in accordance with IPC-SM-B40C, Type B, Class 2, and be green in color.
14. Solder mask mis-registration ± 0.004 in. max.
15. Silkscreen shall be permanent non-conductive white ink.
16. The fabrication process shall be UL approved and the PCB shall have a flammability rating of UL94V0 to be marked on the solder side in silkscreen with date, manufactures approved logo, and type designation.
17. Warp and twist of the PCB shall not exceed 0.0075 in. per in.
18. 100% electrical verification required.
19. Surface finish: electroless nickel immersion gold (ENIG) or HASL
20. RoHS 2002/95/EC compliance required.



Buck Boost Inductor Specification

CUSTOMER	TERMINAL	RoHS	LEAD(Pb)-FREE
Sn96%, Ag4%		Yes	Yes

TERM. NO.'s FOR REF. ONLY

#.020(4) [.50]

PART MUST INSERT FULLY TO SURFACE A IN RECOMMENDED GRID

LOT CODE & DATE CODE

RECOMMENDED P.C. PATTERN, COMPONENT SIDE

ELECTRICAL SPECIFICATIONS @ 25°C unless otherwise noted:

D.C. RESISTANCE (@20°C): 6-2 , 1.35 Ohms ±10%.
 3-5 , 0.425 Ohms ±10%.

DIELECTRIC RATING: 500VAC, 1 minute tested by applying 625VAC for 1 second between pins 6-3.

INDUCTANCE: 1.25mH ±8%, 100kHz, 100mVAC, 0mADC, 6-2, Ls.

SATURATION CURRENT: >1.0ADC saturating current that causes 20% rolloff from initial inductance.

LEAKAGE INDUCTANCE: 85µH typ., 120µH max., 100kHz, 100mVAC, 6-2(tie 3+5), Ls.

TURNS RATIO: (6-2):(3-5), (8):(1.00), ±2%.

OPERATING TEMPERATURE RANGE: -40°C to +125°C including temp rise.

Wire insulation & RoHS status not affected by wire color. Wire insulation color may vary depending on availability.

Würth Electronics Midcom Inc. Watertown, SD USA Toll Free: 800-643-2661 Fax: 605-886-4486	Unless otherwise specified, tolerances are as follows: Angles: ±1° Fractions: ±1/64 Decimals: ±.005(.127mm) Footprint: ±.001(.03mm)	more than you expect
	Drawing Title Inductor	Drawing Number Rev. 750314731 00
This drawing is dual dimensioned. Dimensions in brackets are in millimeters.	Revisions: See Sheet 1	Scale ---- Spec Sheet 1 of 1
Engineer:EJK		04/10/2014



ON Semiconductor

ECA Pictures

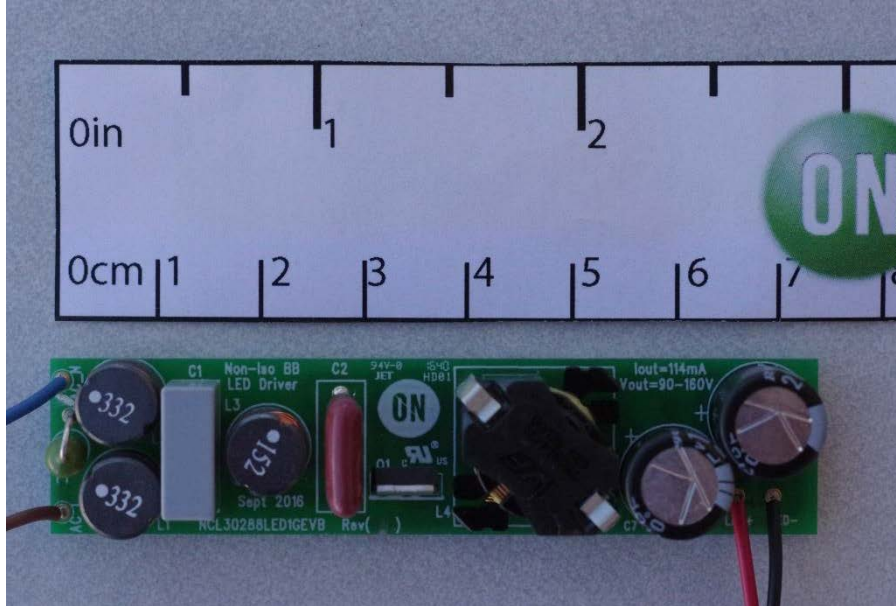

Top View

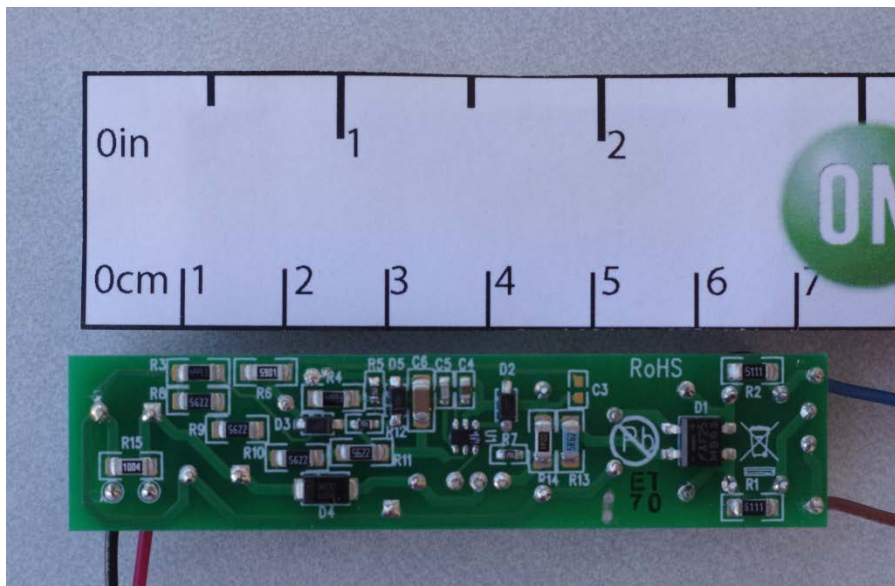

Bottom View

Test Procedure

Equipment Needed

AC Source – 90 to 305 V ac 50/60 Hz Minimum 50 W capability

AC Wattmeter – 100 W Minimum, True RMS Input Voltage, Current, Power Factor, and THDi 0.2% accuracy or better

DC Voltmeter – 300 V dc minimum 0.1% accuracy or better

DC Ammeter – 100 mA dc minimum 0.1% accuracy or better

LED Load – 90 V – 160 V @ 113 mA

Test Connections

1. Connect the LED Load to the red(+) and black(-) leads through the ammeter shown in Figure 7. **Caution: Observe the correct polarity or the load may be damaged.**
2. Connect the AC power to the input of the AC wattmeter shown in Figure 7. Connect the white leads to the output of the AC wattmeter
3. Connect the DC voltmeter as shown in Figure 7.

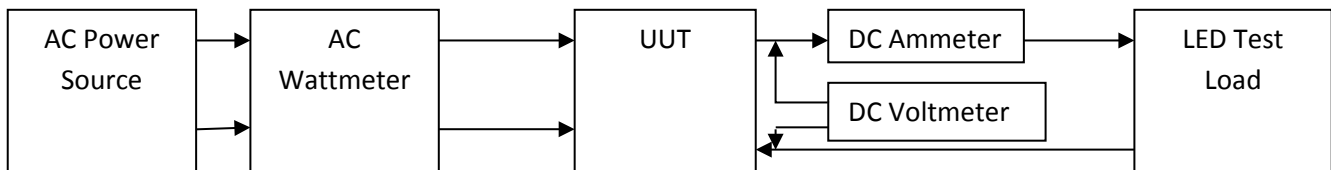

Figure 7. Test Set Up

Note: Unless otherwise specified, all voltage measurements are taken at the terminals of the UUT.



Functional Test Procedure

1. Set the LED Load for ~160V output.
2. Set the input power to 120 V 60 Hz. **Caution: Do not touch the ECA once it is energized because there are hazardous voltages present. This UUT does not provide input/output isolation. Ensure measurement equipment is rated for sufficient common mode voltage.**

Line and Load Regulation

120 V / Max Load

Load Voltage	Output Current 114mA ± 3mA	Output Power	Power Factor	THDi
90V				
135V				
160V				

230V / Max Load

Load Voltage	Output Current 114mA ± 3mA	Output Power	Power Factor	THD < 20%
90V				
135V				
160V				

$$\text{Efficiency} = \frac{V_{out} \times I_{out}}{P_{in}} \times 100\%$$



Test Data

PF and THDi over Line and Load

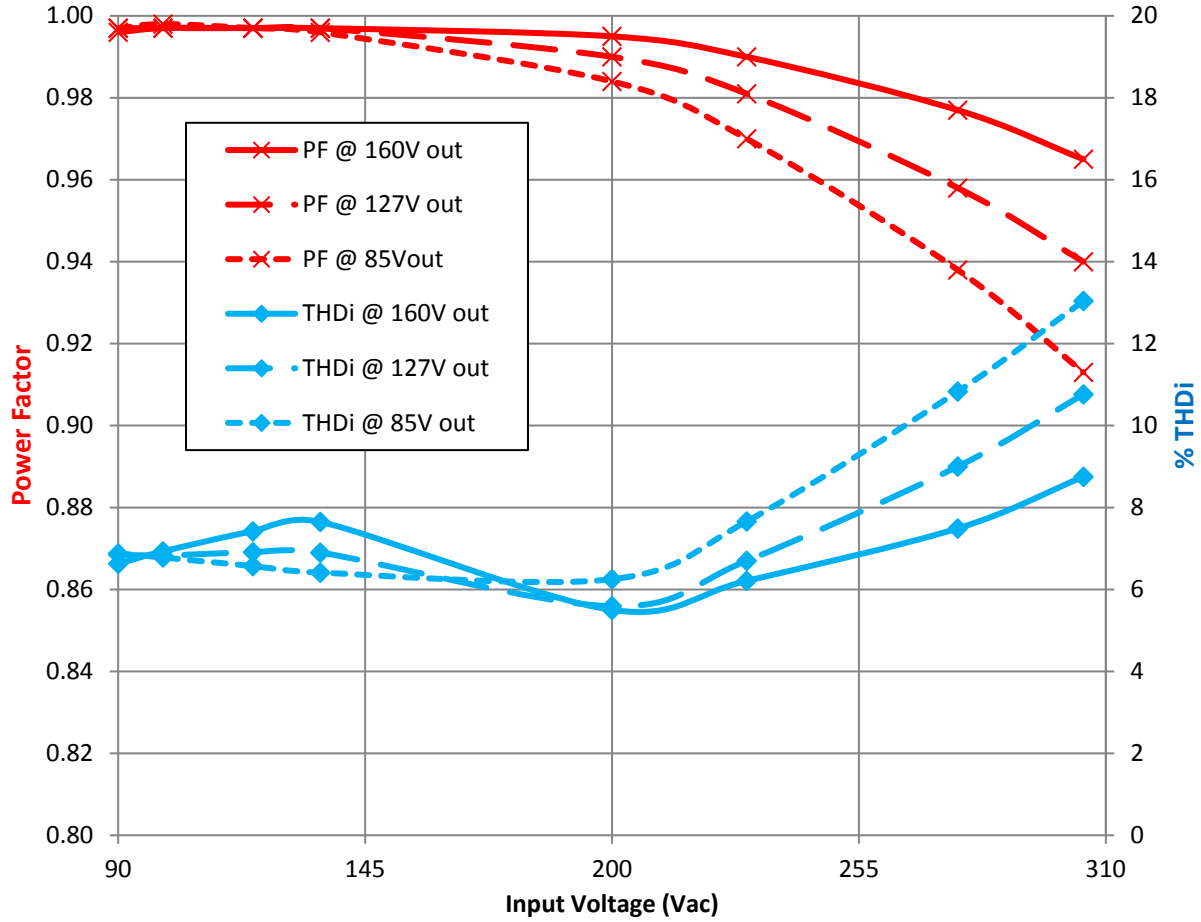

Figure 8. Power Factor and THD over Line and Load



Efficiency

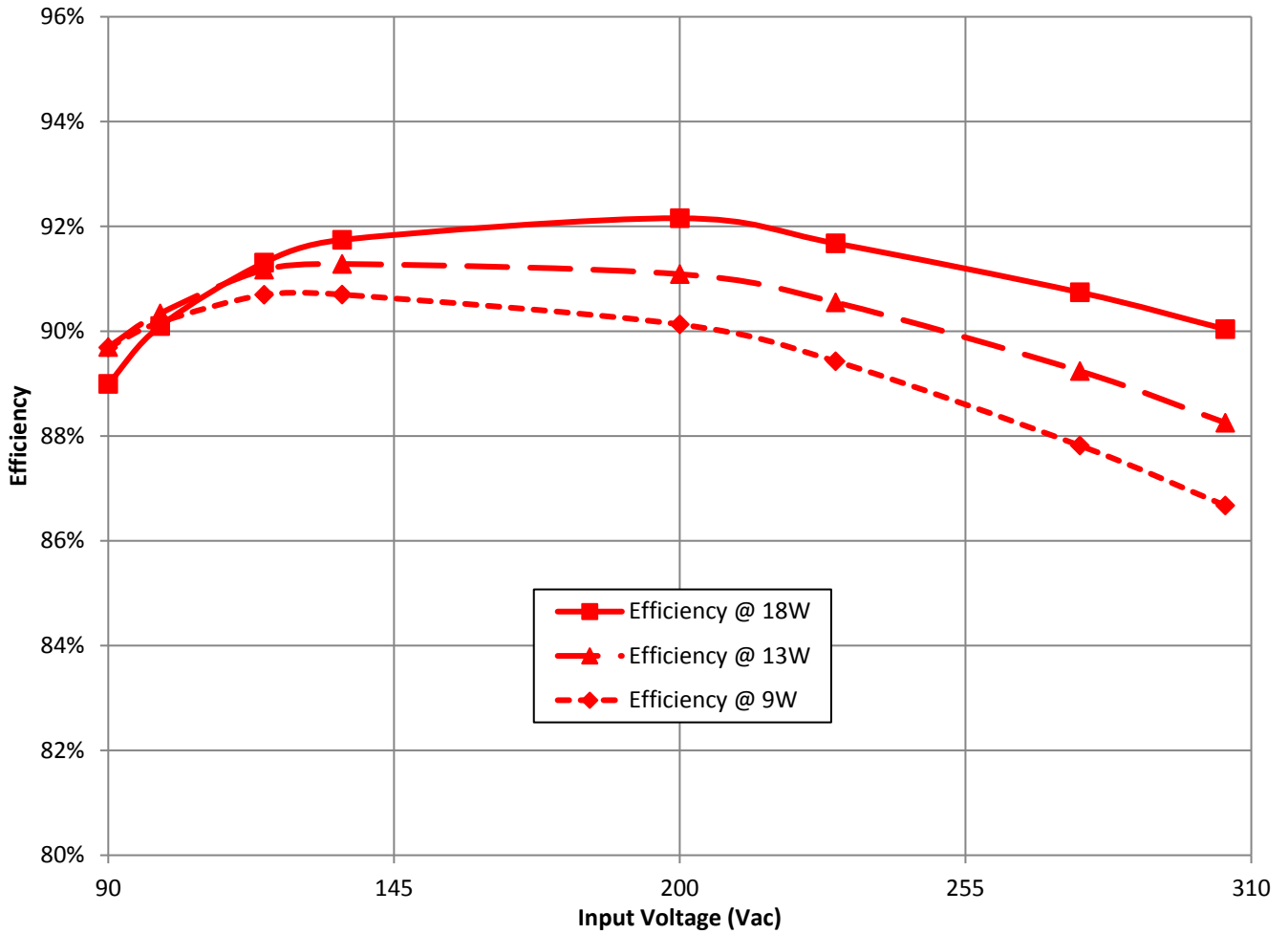

Figure 9. Efficiency over Line and Load



230Vac 50Hz Load Regulation

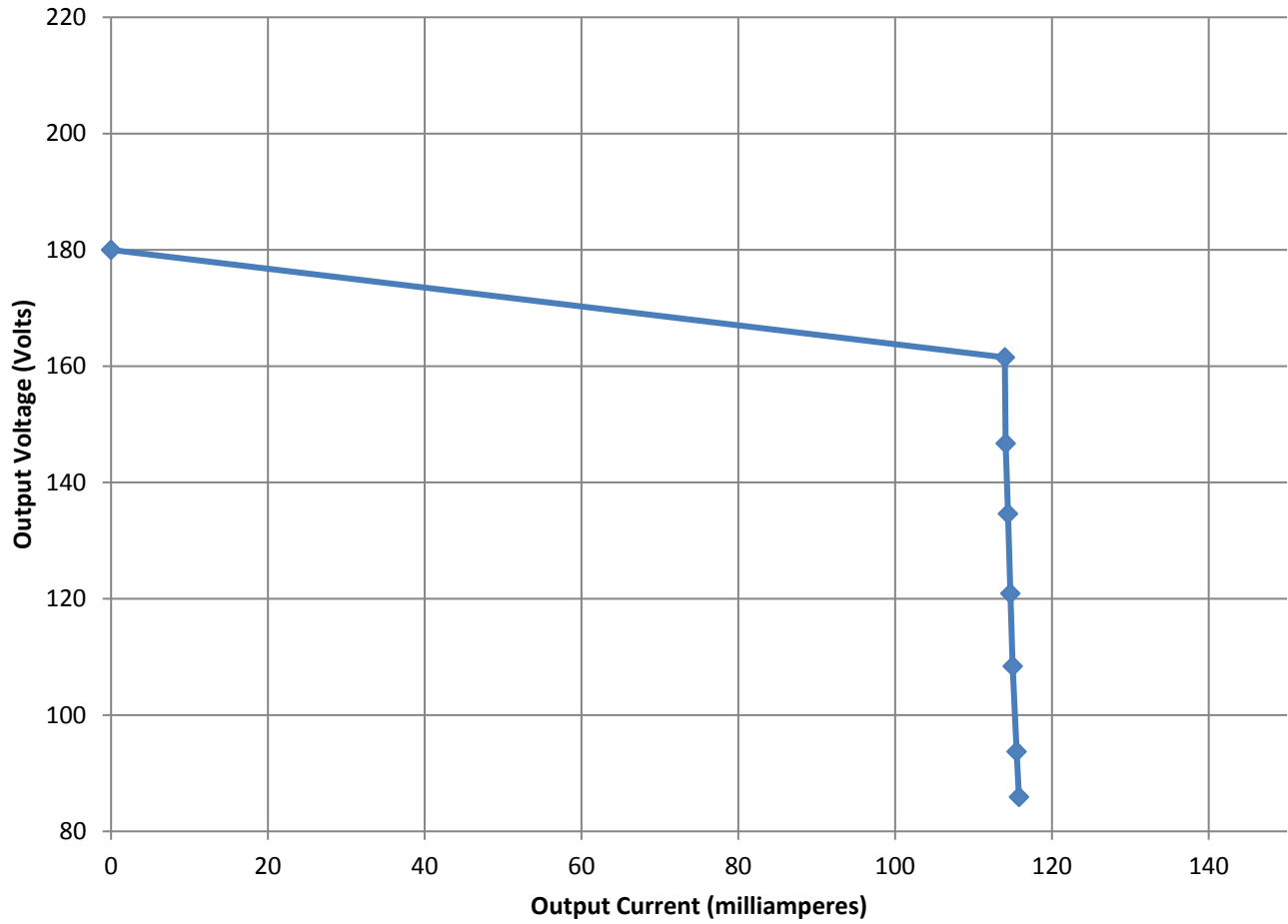
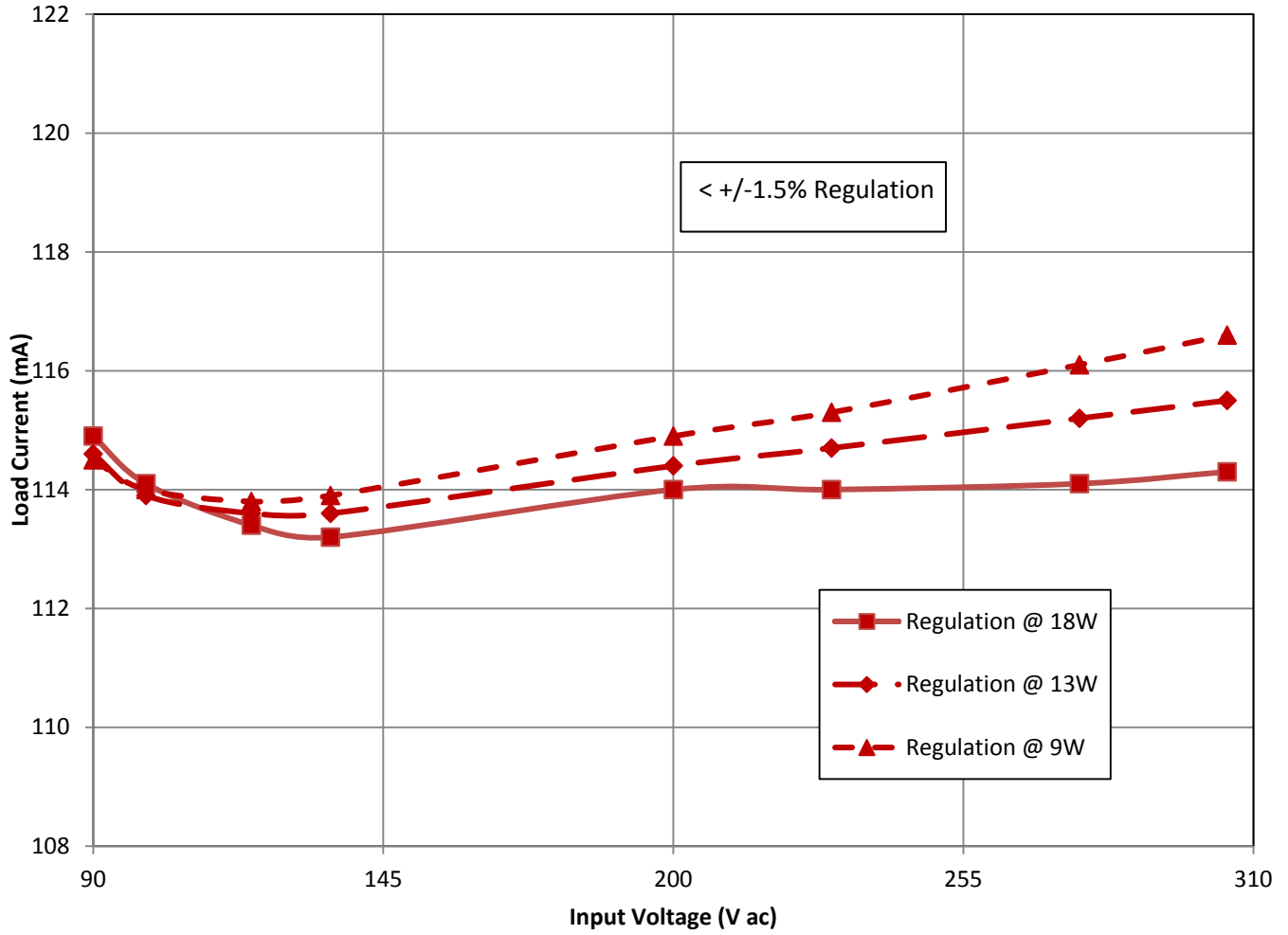

Figure 10. Load Regulation



Figure 11. Line Regulation

Line Regulation



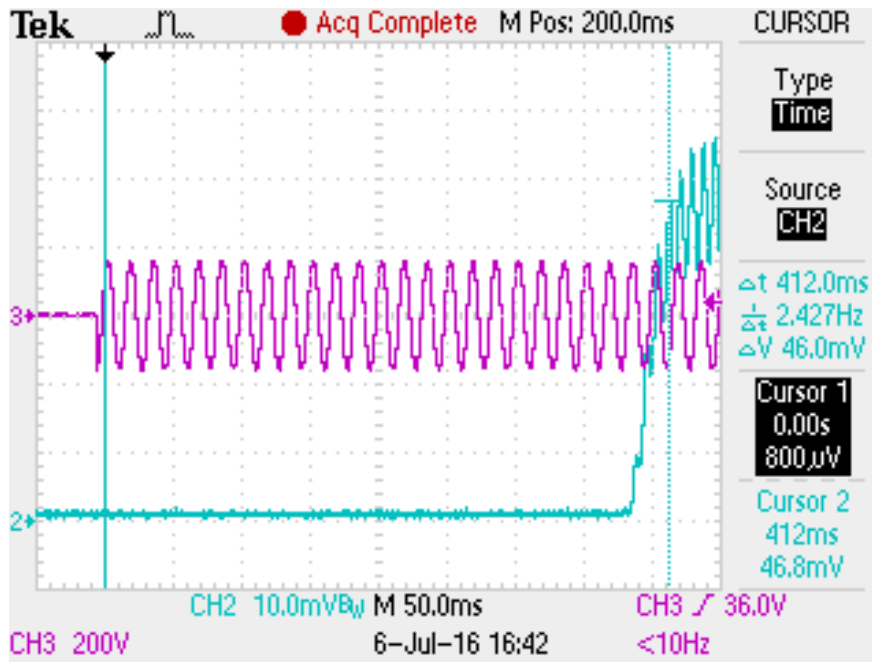

Figure 12. Start Up with AC Applied 120V Maximum Load

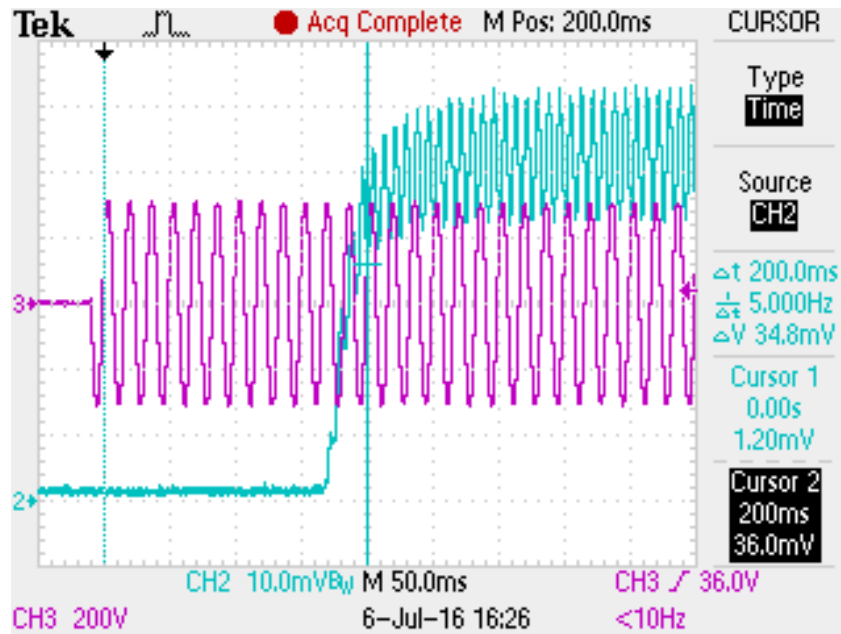
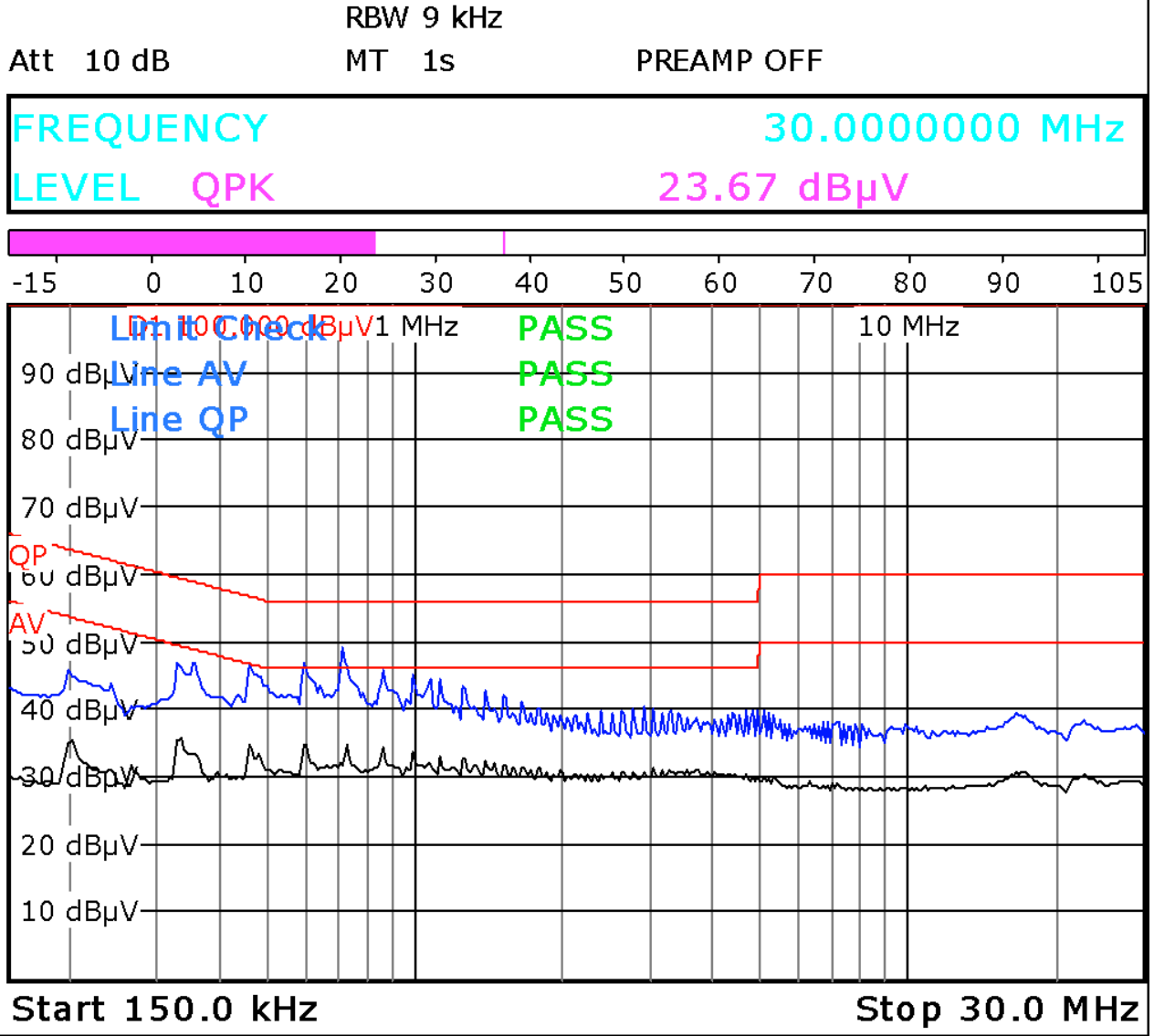

Figure 13. Start Up with AC Applied 230V Maximum Load



Conducted EMI



Date: 10.NOV.2016 14:11:53

Figure 14. Full load Conducted EMI