

Phase leg MOSFET Power Module

$V_{DSS} = 200V$
 $R_{DSon} = 4m\Omega$ typ @ $T_j = 25^\circ C$
 $I_D = 372A$ @ $T_c = 25^\circ C$

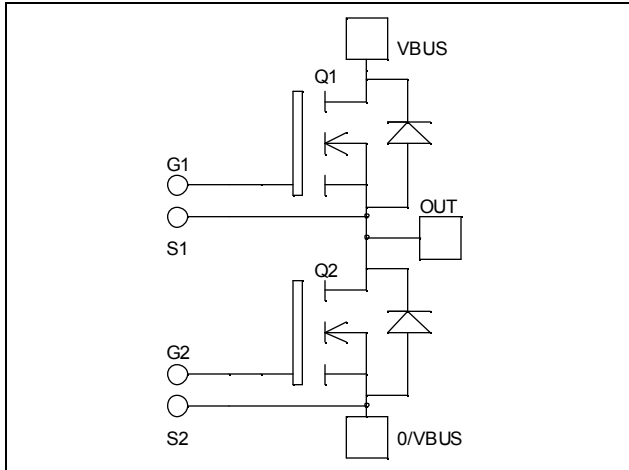

Application

- Welding converters
- Switched Mode Power Supplies
- Uninterruptible Power Supplies
- Motor control

Features

- Power MOS 7[®] FREDFETs
 - Low R_{DSon}
 - Low input and Miller capacitance
 - Low gate charge
 - Fast intrinsic reverse diode
 - Avalanche energy rated
 - Very rugged
- Kelvin source for easy drive
- Very low stray inductance
 - Symmetrical design
 - M5 power connectors
- High level of integration

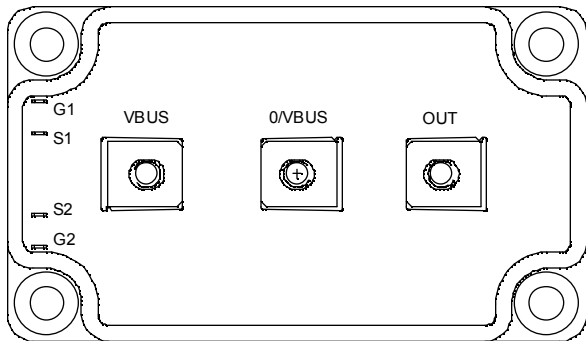

Benefits

- Outstanding performance at high frequency operation
- Direct mounting to heatsink (isolated package)
- Low junction to case thermal resistance
- Low profile
- RoHS Compliant

Absolute maximum ratings

Symbol	Parameter	Max ratings	Unit
V_{DSS}	Drain - Source Breakdown Voltage	200	V
I_D	Continuous Drain Current	$T_c = 25^\circ C$	372
		$T_c = 80^\circ C$	278
I_{DM}	Pulsed Drain current	1488	
V_{GS}	Gate - Source Voltage	± 30	V
R_{DSon}	Drain - Source ON Resistance	5	$m\Omega$
P_D	Maximum Power Dissipation	$T_c = 25^\circ C$	1250
I_{AR}	Avalanche current (repetitive and non repetitive)	100	A
E_{AR}	Repetitive Avalanche Energy	50	mJ
E_{AS}	Single Pulse Avalanche Energy	3000	

CAUTION: These Devices are sensitive to Electrostatic Discharge. Proper Handling Procedures Should Be Followed. See application note APT0502 on www.microsemi.com

All ratings @ $T_j = 25^\circ\text{C}$ unless otherwise specified

Electrical Characteristics

Symbol	Characteristic	Test Conditions	Min	Typ	Max	Unit
I_{DSS}	Zero Gate Voltage Drain Current	$V_{GS} = 0\text{V}, V_{DS} = 200\text{V}$			500	μA
		$V_{GS} = 0\text{V}, V_{DS} = 160\text{V}$			2000	
$R_{DS(on)}$	Drain – Source on Resistance	$V_{GS} = 10\text{V}, I_D = 186\text{A}$		4	5	$\text{m}\Omega$
$V_{GS(th)}$	Gate Threshold Voltage	$V_{GS} = V_{DS}, I_D = 10\text{mA}$	3		5	V
I_{GSS}	Gate – Source Leakage Current	$V_{GS} = \pm 30\text{V}, V_{DS} = 0\text{V}$			± 200	nA

Dynamic Characteristics

Symbol	Characteristic	Test Conditions	Min	Typ	Max	Unit
C_{iss}	Input Capacitance	$V_{GS} = 0\text{V}$		28.9		nF
C_{oss}	Output Capacitance	$V_{DS} = 25\text{V}$		9.32		
C_{rss}	Reverse Transfer Capacitance	$f = 1\text{MHz}$		0.58		
Q_g	Total gate Charge	$V_{GS} = 10\text{V}$		560		nC
Q_{gs}	Gate – Source Charge	$V_{Bus} = 100\text{V}$		212		
Q_{gd}	Gate – Drain Charge	$I_D = 372\text{A}$		268		
$T_{d(on)}$	Turn-on Delay Time	Inductive switching @ 125°C $V_{GS} = 15\text{V}$ $V_{Bus} = 133\text{V}$ $I_D = 372\text{A}$ $R_G = 1.2\Omega$		32		ns
T_r	Rise Time			64		
$T_{d(off)}$	Turn-off Delay Time			88		
T_f	Fall Time			116		
E_{on}	Turn-on Switching Energy	Inductive switching @ 25°C $V_{GS} = 15\text{V}, V_{Bus} = 133\text{V}$ $I_D = 372\text{A}, R_G = 1.2\Omega$		3396		μJ
E_{off}	Turn-off Switching Energy			3716		
E_{on}	Turn-on Switching Energy	Inductive switching @ 125°C $V_{GS} = 15\text{V}, V_{Bus} = 133\text{V}$ $I_D = 372\text{A}, R_G = 1.2\Omega$		3744		μJ
E_{off}	Turn-off Switching Energy			3944		

Source - Drain diode ratings and characteristics

Symbol	Characteristic	Test Conditions	Min	Typ	Max	Unit	
I_S	Continuous Source current (Body diode)	$T_c = 25^\circ\text{C}$			372	A	
		$T_c = 80^\circ\text{C}$			278		
V_{SD}	Diode Forward Voltage	$V_{GS} = 0\text{V}, I_S = -372\text{A}$			1.3	V	
dv/dt	Peak Diode Recovery ①				5	V/ns	
t_{rr}	Reverse Recovery Time	$I_S = -372\text{A}$ $V_R = 133\text{V}$ $di_S/dt = 400\text{A}/\mu\text{s}$	$T_j = 25^\circ\text{C}$			230	ns
			$T_j = 125^\circ\text{C}$			450	
Q_{rr}	Reverse Recovery Charge	$I_S = -372\text{A}$ $V_R = 133\text{V}$ $di_S/dt = 400\text{A}/\mu\text{s}$	$T_j = 25^\circ\text{C}$		3.6	μC	
			$T_j = 125^\circ\text{C}$		13.6		

 ① dv/dt numbers reflect the limitations of the circuit rather than the device itself.

$$I_S \leq -372\text{A} \quad di/dt \leq 700\text{A}/\mu\text{s} \quad V_R \leq V_{DSS} \quad T_j \leq 150^\circ\text{C}$$

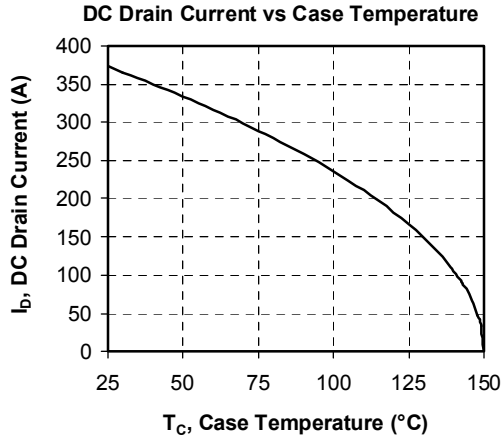
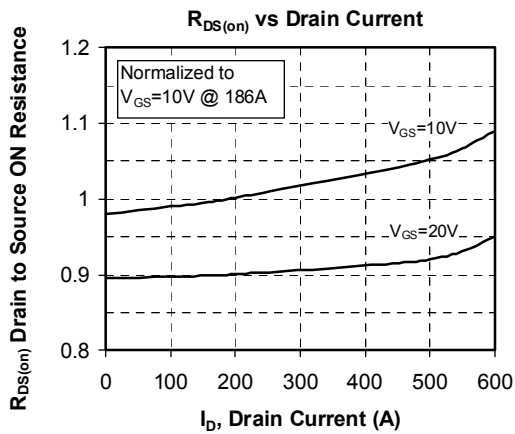
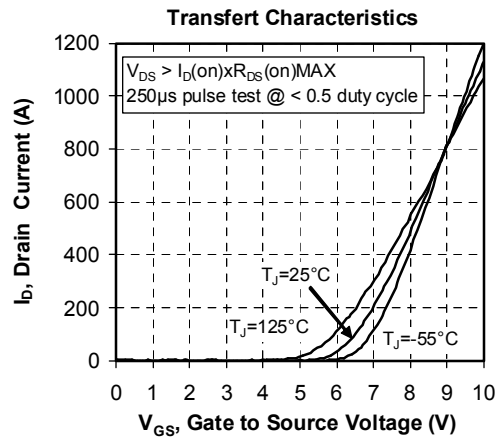
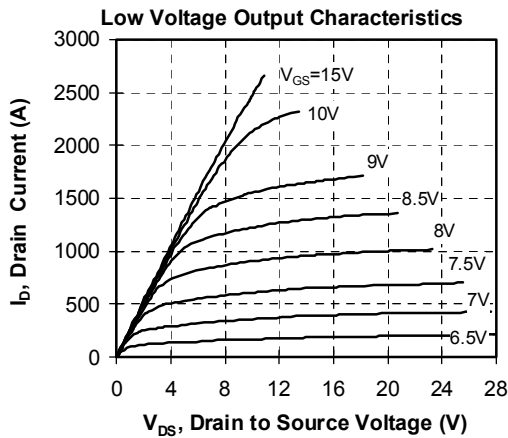
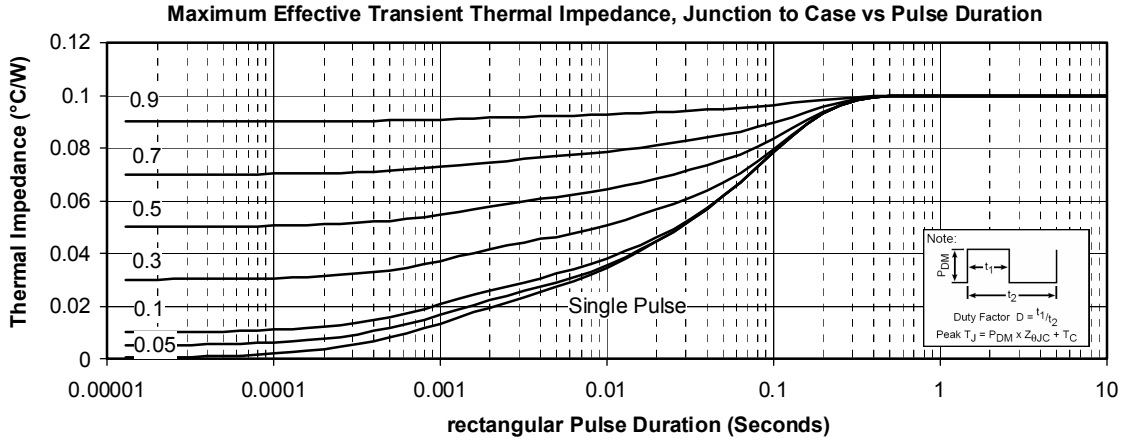
Typical Performance Curve

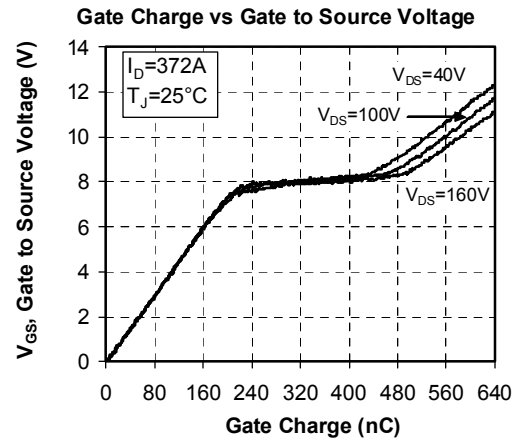
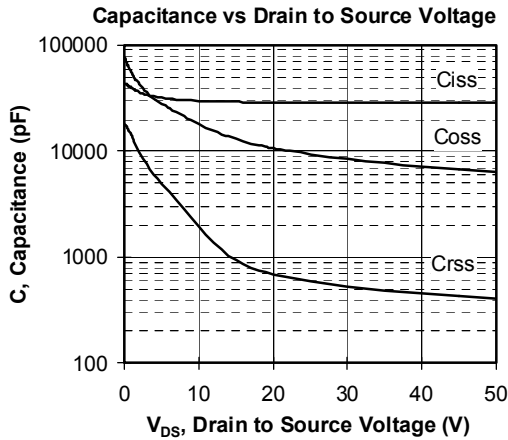
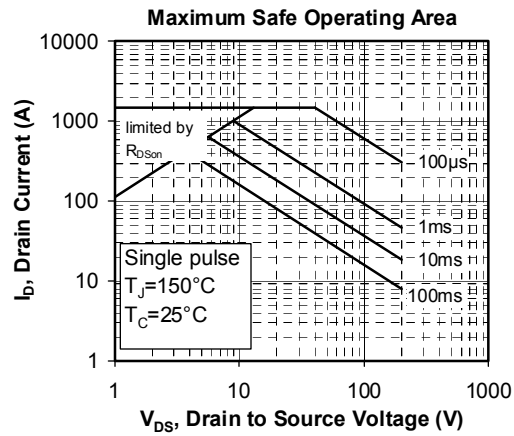
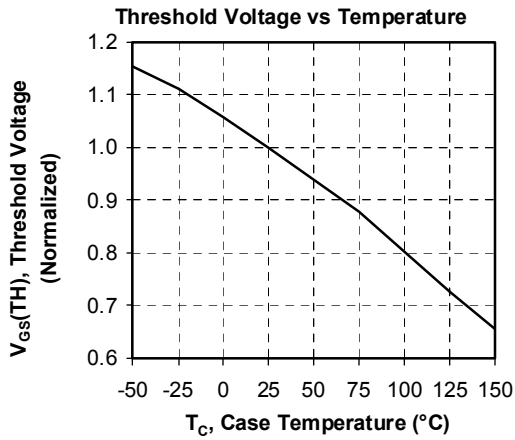
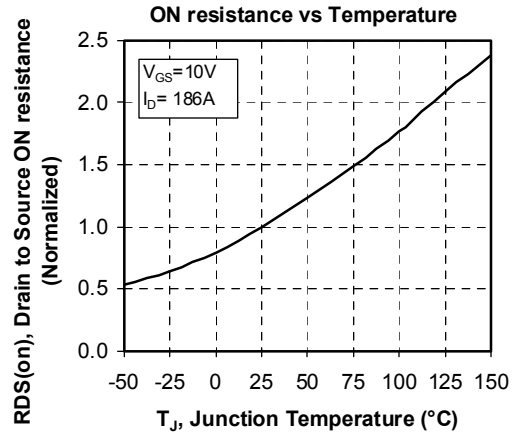

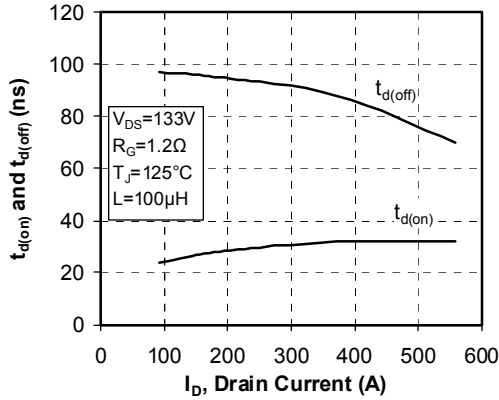
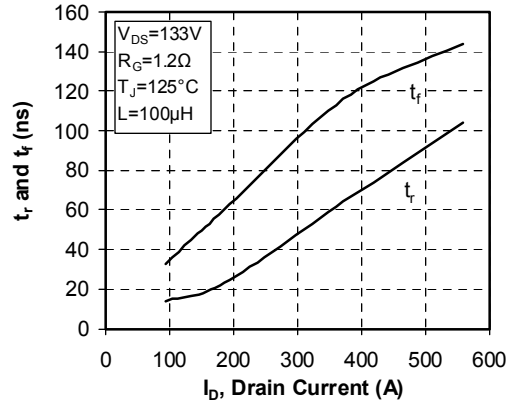
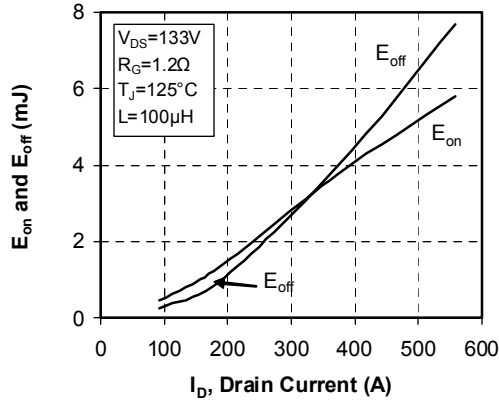
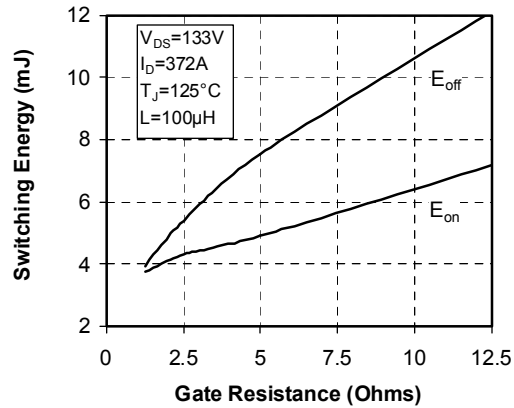
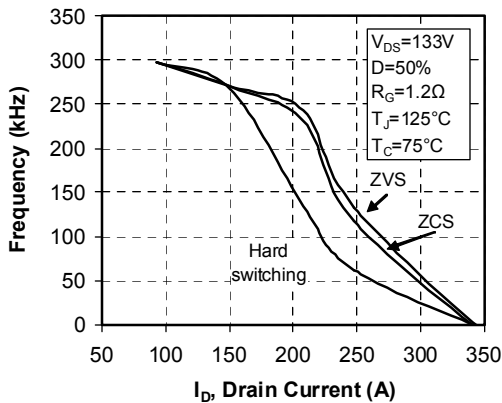
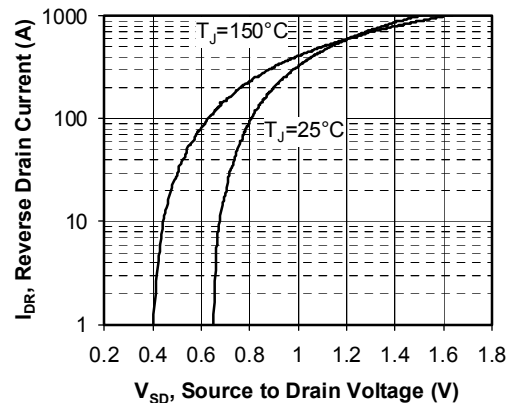
Delay Times vs Current

Rise and Fall times vs Current

Switching Energy vs Current

Switching Energy vs Gate Resistance

Operating Frequency vs Drain Current

Source to Drain Diode Forward Voltage

Microsemi reserves the right to change, without notice, the specifications and information contained herein

Microsemi's products are covered by one or more of U.S. patents 4,895,810 5,045,903 5,089,434 5,182,234 5,019,522 5,262,336 6,503,786 5,256,583 4,748,103 5,283,202 5,231,474 5,434,095 5,528,058 and foreign patents. U.S. and Foreign patents pending. All Rights Reserved.