

TwinChip™ Series - DO-214



Agency Approvals

Agency	Agency File Number
	E133083

Description

TwinChip™ Series DO-214 are very low capacitance SIDACtor® thyristors designed to protect broadband equipment such as VoIP, DSL modems and DSLAMs from damaging overvoltage transients. This series provides a surface mount solution that enables equipment to comply with global regulatory standards, while limiting the impact to broadband signals.

Features and Benefits

- Low voltage overshoot
- Low on-state voltage
- Does not degrade surge capability after multiple surge events within limit.
- Low distortion
- Fails short circuit when surged in excess of ratings
- 40% lower than comparable product
- RoHS Compliant and Halogen-Free
- Pb-free E3 means 2nd level interconnect is Pb-free and the terminal finish material is tin(Sn) (IPC/JEDEC J-STD-609A.01)
- Recognized to UL 497B as an Isolated Loop Circuit Protector

Schematic Symbol



Applicable Global Standards

- TIA/968-A/B
- ITU K.20/21/45
- IEC 61000-4-5 2nd edition
- GR 1089 Intra-building
- YD/T 1082
- YD/T 993
- YD/T 950
- ITU K.20/21/45 Enhanced*
- GR 1089 Inter-building*

* Additional series resistance may be required to comply

Additional Information



Datasheet



Resources



Samples

Electrical Characteristics

Part Number	Marking	V_{DRM} @ $I_{DRM} = 5\mu A$	V_S @ 100V/ μs	I_H	I_S	I_T	V_T @ $I_T = 2.2$ Amps	@ 1MHz, 2V bias	
		V min	V max	mA min	mA max	A max	V max	pF min	pF max
P0642SALRP	P062A	58	77	120	800	2.2	8	25	45
P0722SALRP	P072A	65	88	120	800	2.2	8	20	45
P0902SALRP	P092A	75	98	120	800	2.2	8	20	40
P1102SALRP	P112A	90	130	120	800	2.2	8	15	35
P1302SALRP	P132A	120	160	120	800	2.2	8	15	35
P1502SALRP	P152A	140	180	120	800	2.2	8	15	30
P1802SALRP	P182A	170	220	120	800	2.2	8	10	30
P2302SALRP	P232A	190	260	120	800	2.2	8	10	25
P2602SALRP	P262A	220	300	120	800	2.2	8	10	25
P3002SALRP	P302A	280	360	120	800	2.2	8	10	25
P3502SALRP	P352A	320	400	120	800	2.2	8	10	20
P4202SALRP	P422A	380	500	120	800	2.2	8	10	20
P4802SALRP	P482A	440	600	120	800	2.2	8	5	20
P6002SALRP	P602A	550	700	120	800	2.2	8	5	20
P0642SBLRP	P062B	58	77	120	800	2.2	8	25	45
P0722SBLRP	P072B	65	88	120	800	2.2	8	20	45
P0902SBLRP	P092B	75	98	120	800	2.2	8	20	40
P1102SBLRP	P112B	90	130	120	800	2.2	8	15	35
P1302SBLRP	P132B	120	160	120	800	2.2	8	15	35
P1502SBLRP	P152B	140	180	120	800	2.2	8	15	30
P1802SBLRP	P182B	170	220	120	800	2.2	8	10	30
P2302SBLRP	P232B	190	260	120	800	2.2	8	10	25
P2602SBLRP	P262B	220	300	120	800	2.2	8	10	25
P3002SBLRP	P302B	280	360	120	800	2.2	8	10	25
P3502SBLRP	P352B	320	400	120	800	2.2	8	10	20
P4202SBLRP	P422B	380	500	120	800	2.2	8	10	20
P4802SBLRP	P482B	440	600	120	800	2.2	8	5	20
P6002SBLRP	P602B	550	700	120	800	2.2	8	5	20
P3002SCLRP	P302C	280	360	120	800	2.2	8	20	35
P3502SCLRP	P352C	320	400	120	800	2.2	8	20	30
P4202SCLRP	P422C	380	500	120	800	2.2	8	15	30
P4802SCLRP	P482C	440	600	120	800	2.2	8	15	30
P6002SCLRP	P602C	550	700	120	800	2.2	8	10	25
P7002SCLRP	P702C	640	850	120	800	2.2	8	10	30

Notes:

- Absolute maximum ratings measured at $T_A = 25^\circ C$ (unless otherwise noted).
- Components are bi-directional.

Surge Ratings

Series	I_{PP}									I_{TSM} 50/60 Hz	di/dt
	0.2/310 ¹ 0.5/700 ²	2/10 ¹ 2/10 ²	8/20 ¹ 1.2/50 ²	10/160 ¹ 10/160 ²	10/560 ¹ 10/560 ²	5/320 ¹ 9/720 ²	10/360 ¹ 10/360 ²	10/1000 ¹ 10/1000 ²	5/310 ¹ 10/700 ²		
	A min	A min	A min	A min	A min	A min	A min	A min	A min	A min	A/ μs
A	20	150	150	90	50	75	75	45	75	20	500
B	25	250	250	150	100	100	125	80	100	25	500
C	50	500	400	200	150	200	175	100	200	30	500

Notes:

- Current waveform in μs
 - Voltage waveform in μs
- Peak pulse current rating (I_{PP}) is repetitive and guaranteed for the life of the product that remains in thermal equilibrium.
 - I_{PP} ratings applicable over temperature range of $-40^\circ C$ to $+85^\circ C$
 - The component must initially be in thermal equilibrium with $-40^\circ C \leq T_J \leq +150^\circ C$

Thermal Considerations

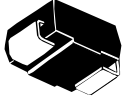
Package	Symbol	Parameter	Value	Unit
 DO-214AA	T_J	Operating Junction Temperature Range	-40 to +150	°C
	T_S	Storage Temperature Range	-65 to +150	°C
	$R_{\theta JA}$	Thermal Resistance: Junction to Ambient	90	°C/W

V-I Characteristics

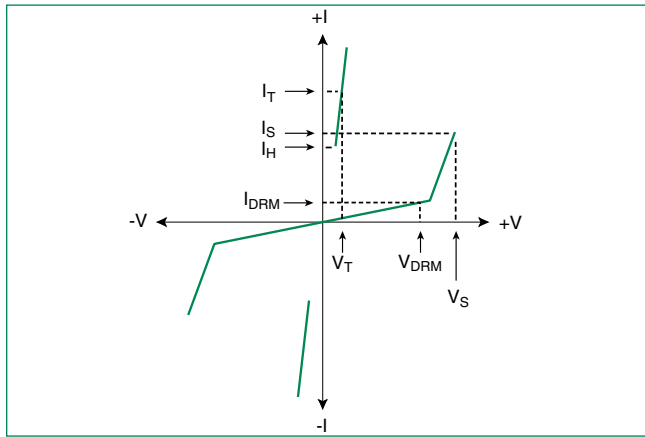

$t_r \times t_d$ Pulse Waveform

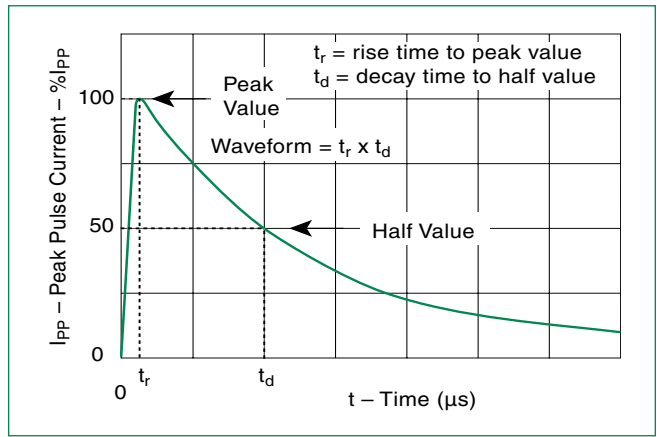

Normalized V_S Change vs. Junction Temperature

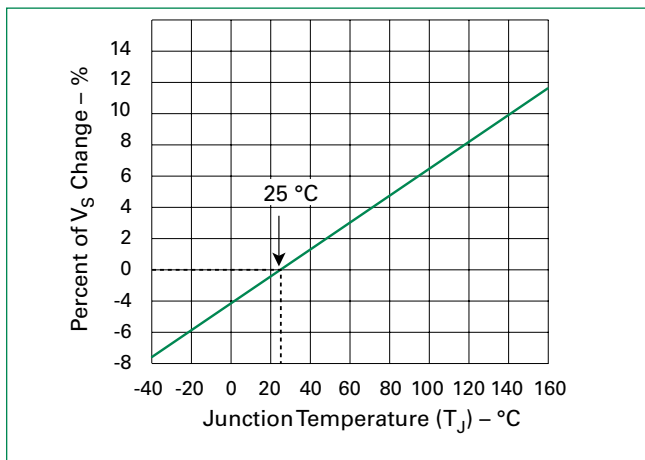

Normalized DC Holding Current vs. Case Temperature

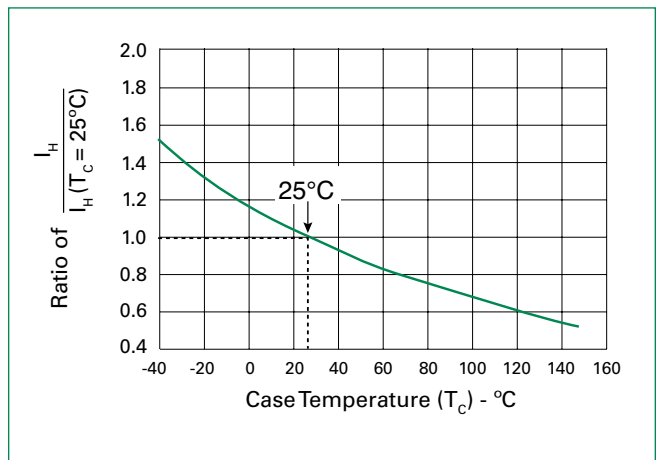

Soldering Parameters

Reflow Condition		Pb-Free assembly
Pre Heat	- Temperature Min ($T_{s(min)}$)	+150°C
	- Temperature Max ($T_{s(max)}$)	+200°C
	- Time (Min to Max) (t_s)	60-180 secs.
Average ramp up rate (Liquidus Temp (T_L) to peak)		3°C/sec. Max.
$T_{s(max)}$ to T_L - Ramp-up Rate		3°C/sec. Max.
Reflow	- Temperature (T_L) (Liquidus)	+217°C
	- Temperature (t_L)	60-150 secs.
Peak Temp (T_p)		+260(+0/-5)°C
Time within 5°C of actual Peak Temp (t_p)		30 secs. Max.
Ramp-down Rate		6°C/sec. Max.
Time 25°C to Peak Temp (T_p)		8 min. Max.
Do not exceed		+260°C

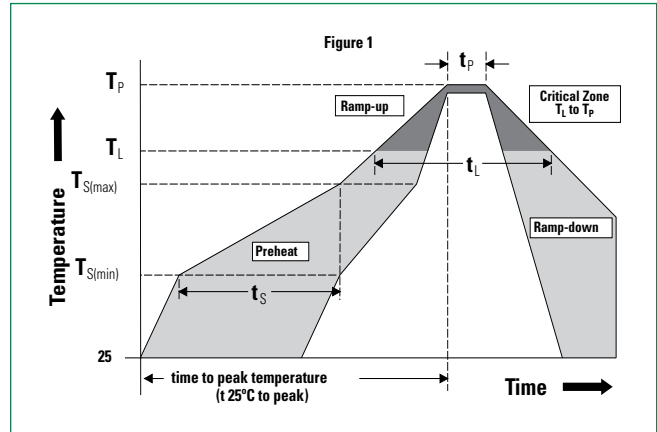

Physical Specifications

Lead Material	Copper Alloy
Terminal Finish	100% Matte-Tin Plated
Body Material	UL Recognized epoxy meeting flammability classification V-0

Environmental Specifications

High Temp Voltage Blocking	80% Rated V_{DRM} (V_{AC} Peak) +125°C or +150°C, 504 or 1008 hrs. MIL-STD-750 (Method 1040) JEDEC, JESD22-A-101
Temp Cycling	-65°C to +150°C, 15 min. dwell, 10 up to 100 cycles. MIL-STD-750 (Method 1051) EIA/JEDEC, JESD22-A104
Biased Temp & Humidity	52 V_{DC} (+85°C) 85%RH, 504 up to 1008 hrs. EIA/JEDEC, JESD22-A-101
High Temp Storage	+150°C 1008 hrs. MIL-STD-750 (Method 1031) JEDEC, JESD22-A-101
Low Temp Storage	-65°C, 1008 hrs.
Thermal Shock	0°C to +100°C, 5 min. dwell, 10 sec. transfer, 10 cycles. MIL-STD-750 (Method 1056) JEDEC, JESD22-A-106
Autoclave (Pressure Cooker Test)	+121°C, 100%RH, 2atm, 24 up to 168 hrs. EIA/JEDEC, JESD22-A-102
Resistance to Solder Heat	+260°C, 30 secs. MIL-STD-750 (Method 2031)
Moisture Sensitivity Level	85%RH, +85°C, 168 hrs., 3 reflow cycles (+260°C Peak). JEDEC-J-STD-020, Level 1

Part Marking

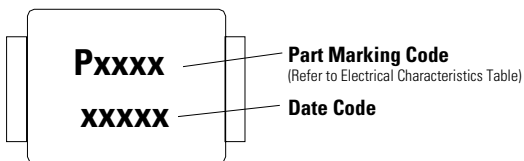

Dimensions – DO-214AA

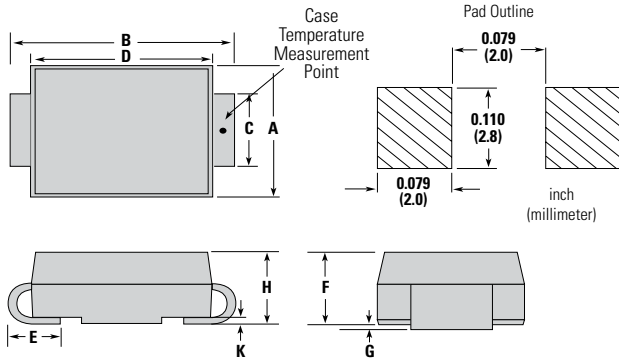

Dimensions	Inches		Millimeters	
	Min	Max	Min	Max
A	0.130	0.156	3.30	3.95
B	0.201	0.220	5.10	5.60
C	0.077	0.087	1.95	2.20
D	0.159	0.181	4.05	4.60
E	0.030	0.063	0.75	1.60
F	0.075	0.096	1.90	2.45
G	0.002	0.008	0.05	0.20
H	0.077	0.104	1.95	2.65
K	0.006	0.016	0.15	0.41

Part Numbering

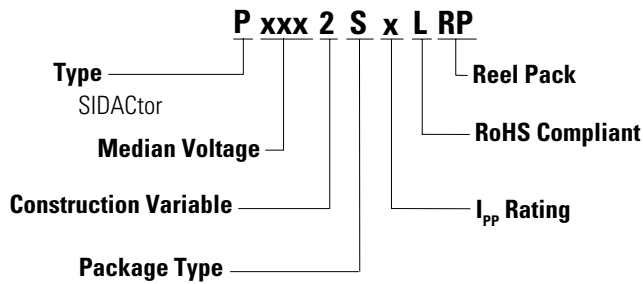

Packing Options

Package Type	Description	Quantity	Added Suffix	Industry Standard
S	DO-214AA Tape & Reel	2500	RP	EIA-481-D

Tape and Reel Specification – DO-214AA

