

PROD NO
SEE NOTE

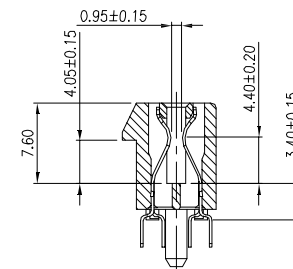

SECTION A-A

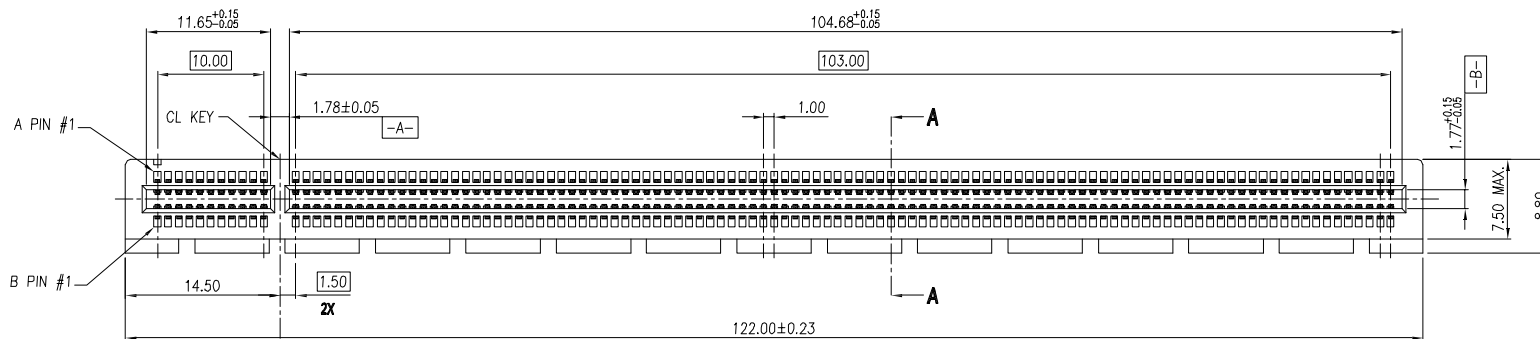
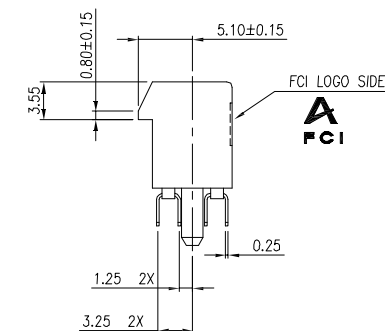

A

A

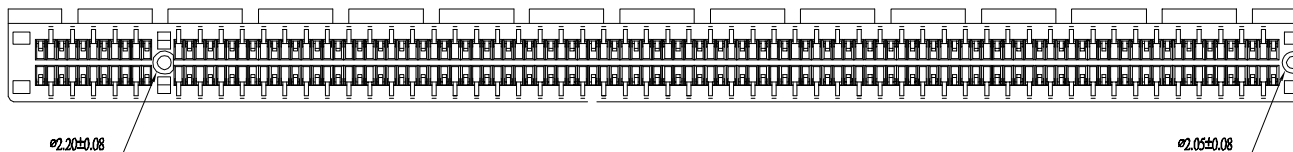
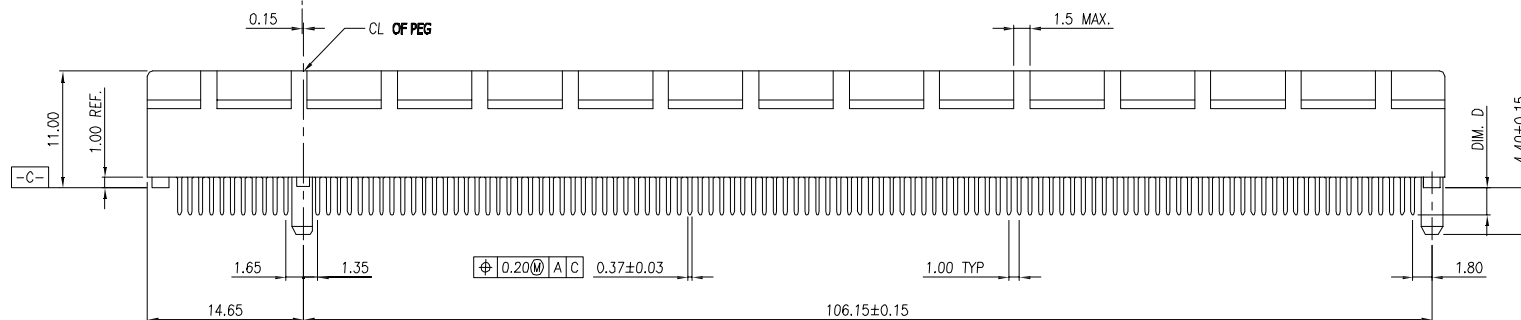

B

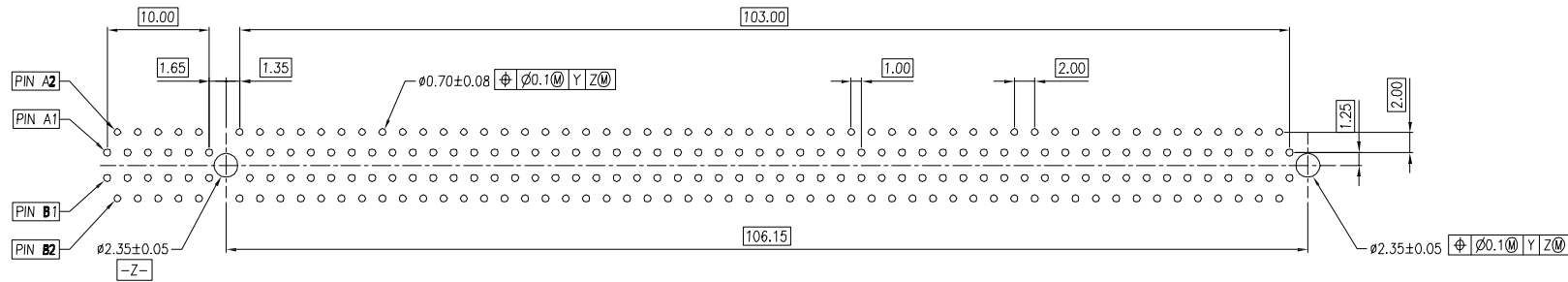

B

mat'l. code				tolerances unless otherwise specified				CUSTOMER COPY		 www.fciconnect.com	
ltr	ecn no	dr	date	linear	.X ±.38			projection	title		
A	T06-0076	J.H	11/30/05		.XX ±.25				PCI-E 230P CARD EDGE GEN3		
B	ELX-DG-2161-1	S T	05/27/15		.XXX ±.10						
				angles	0° ±2'			 MM scale N/A	product family		code
				dr	STONE LI	05/27/15	PCI		-		
				engr	STONE LI	05/27/15	size		-		
				chr	/	/	A4		10063960		
				appd	PM ZHENG	05/27/15	sheet		1 of 4		
sheet index	revision sheet	B	B	B	B						
		1	2	3	4						

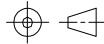

← I/O PANEL DIRECTION

RECOMMENDED FOOTPRINT

mat'l. code				tolerances unless otherwise specified				CUSTOMER COPY		 www.fciconnect.com	
ltr	ecn no	dr	date	linear	.X ±.38			projection	title		
					.XX ±.25				PCI-E 230P CARD EDGE GEN3		
					.XXX ±.10						
				angles	0° ±2°						
				dr	STONE LI	05/27/15	MM	product family		PCI	
				enr	STONE LI	05/27/15		size		dwg no	
				chr	/	/		scale		N/A	
				appd	PM ZHENG	05/27/15	A4		10063960		
sheet index	revision sheet										

cage code
22526

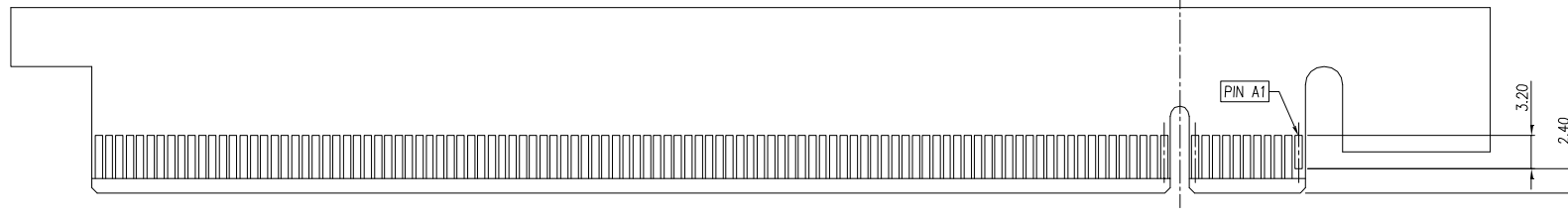

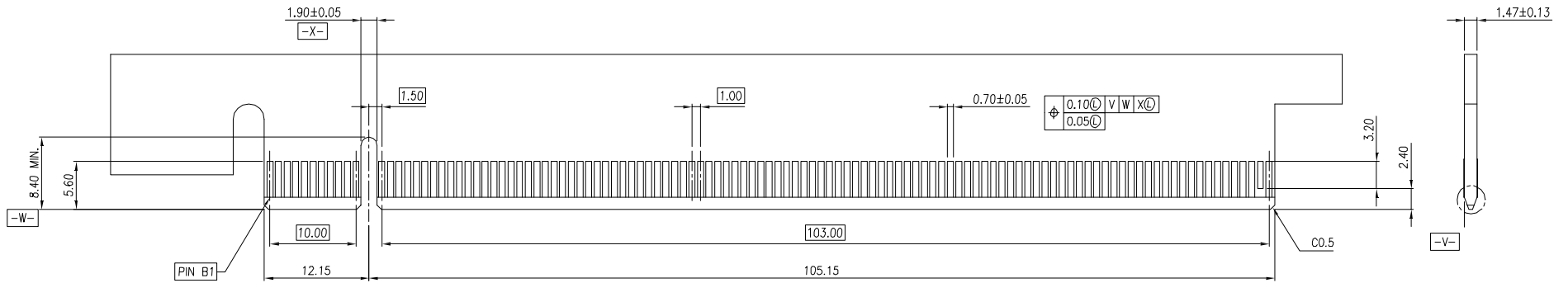

I/O PANEL DIRECTION SECONDARY (SOLDER) SIDE →



← I/O PANEL DIRECTION PRIMARY (COMPONENT) SIDE

ADD-IN CARD EDGE-FINGER DIMENSIONS

SCALE 2:1

mat'l. code				tolerances unless otherwise specified			CUSTOMER COPY		 www.fciconnect.com		
ltr	ecn no	dr	date	linear	.X ±.38		projection	 title PCI-E 230P CARD EDGE GEN3			
					.XX ±.25						
					.XXX ±.10						
				angles	0° ±2°		 scale N/A	product family PCI		code	
				dr	STONE LI	05/27/15		size		dwg no	—
				engr	STONE LI	05/27/15		A4		10063960	sheet 3 of 4
				chr	/	/					
				appd	PM ZHENG	05/27/15					
sheet index		revision sheet									

cage code
22526

NOTES:

1.MATERIAL:

HOUSING: THERMOPLASTIC WITH GLASS FIBER, UL94V-0, COLOR IN BLACK.

CONTACTS: COPPER ALLOY.

2.FINISH:

CONTACTS: GOLD PLATING ON CONTACT AREA, 100u"MIN. TIN/LEAD OR MATTE TIN (LEAD FREE OPTION) PLATING ON SOLDERTAILS, 50u"MIN. NICKEL UNDERPLATING OVER ALL.

3. DURABILITY: 50 CYCLES.

4. RoHS COMPATIBLE PRODUCT SPECIFICATIONS

a. PLATING: "LF" MEANS THE PRODUCT IS LEAD FREE, 2.5um min. MATTE PURE TIN OVER 1.27um MIN. NICKEL UNDERPLATE.

b. MANUFACTURING PROCESS COMPATIBILITY: THE HOUSING WILL WITHSTAND EXPOSURE TO 260C±5C° SOLDER BATH TEMPERATURE FOR 5 SECONDS IN A WAVE SOLDER APPLICATION WITH A 1.60MM THICK CIRCUIT BOARD.

PRODUCT NUMBER CODE
10063960 - X X X X 0 T L F

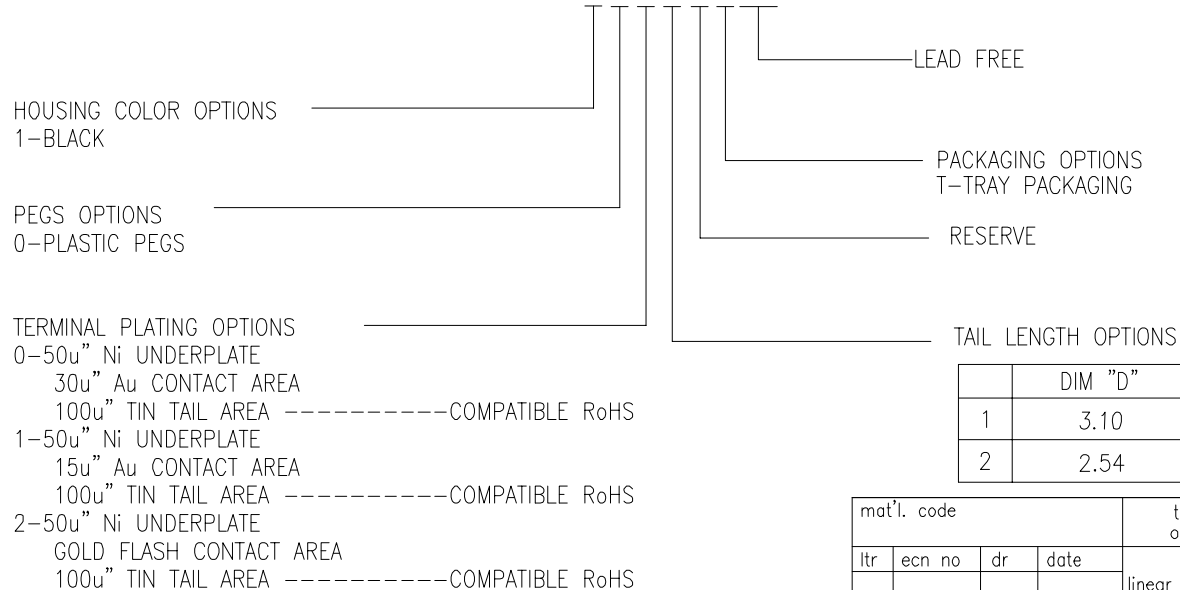

	DIM "D"	SUGGESTED PCB THICKNESS
1	3.10	2.36±0.10
2	2.54	1.56±0.10

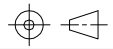
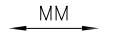
mat'l. code				tolerances unless otherwise specified		CUSTOMER COPY		 www.fciconnect.com	
ltr	ecn no	dr	date	linear	.X ±.38		projection	title	
					.XX ±.25			PCI-E 230P CARD EDGE GEN3	
					.XXX ±.10				
				angles	0° ±2°		 MM	product family PCI	
				dr	STONE LI	05/27/15		code	
				engr	STONE LI	05/27/15		-	
				chr	/	/		sheet	
				appd	PM ZHENG	05/27/15	scale	4 of 4	
sheet index		revision sheet				N/A		A4 10063960	

cage code
22526