

# IS31FL3732A

## AUDIO MODULATED MATRIX LED DRIVER

July 2017

### GENERAL DESCRIPTION

The IS31FL3732A is a compact LED driver for 144 single LEDs. The device can be programmed via an I2C compatible interface. The IS31FL3732A offers two blocks each driving 72 LEDs with 1/9 cycle rate. The required lines to drive all 144 LEDs are reduced to 18 by using the cross-plexing feature optimizing space on the PCB. Additionally each of the 144 LEDs can be dimmed individually with 8-bit allowing 256 steps of linear dimming.

To reduce CPU usage up to 8 frames can be stored with individual time delays between frames to play small animations automatically. LED frames can be modulated with audio signal.

IS31FL3732A is available in QFN-40 (5mm×5mm) package. It operates from 2.7V to 5.5V over the temperature range of -40°C to +85°C.

### FEATURES

- Supply voltage range: 2.7V to 5.5V
- 1MHz I2C-compatible interface
- 144 LEDs in dot matrix
- Individual blink control
- Individual PWM control 256 steps
- Individual on/off control
- Global current control 256 steps
- Cascade for synchronization of chips
- 8 frames memory for animations
- Picture mode and animation mode
- Auto intensity breathing during the switching of different frames
- LED frames displayed can be modulated with audio signal intensity
- LED light intensity can be modulated with audio signal intensity
- QFN-40 (5mm×5mm) package

### APPLICATIONS

- Mobile phones and other hand-held devices for LED display
- LED in home appliances

### TYPICAL APPLICATION CIRCUIT

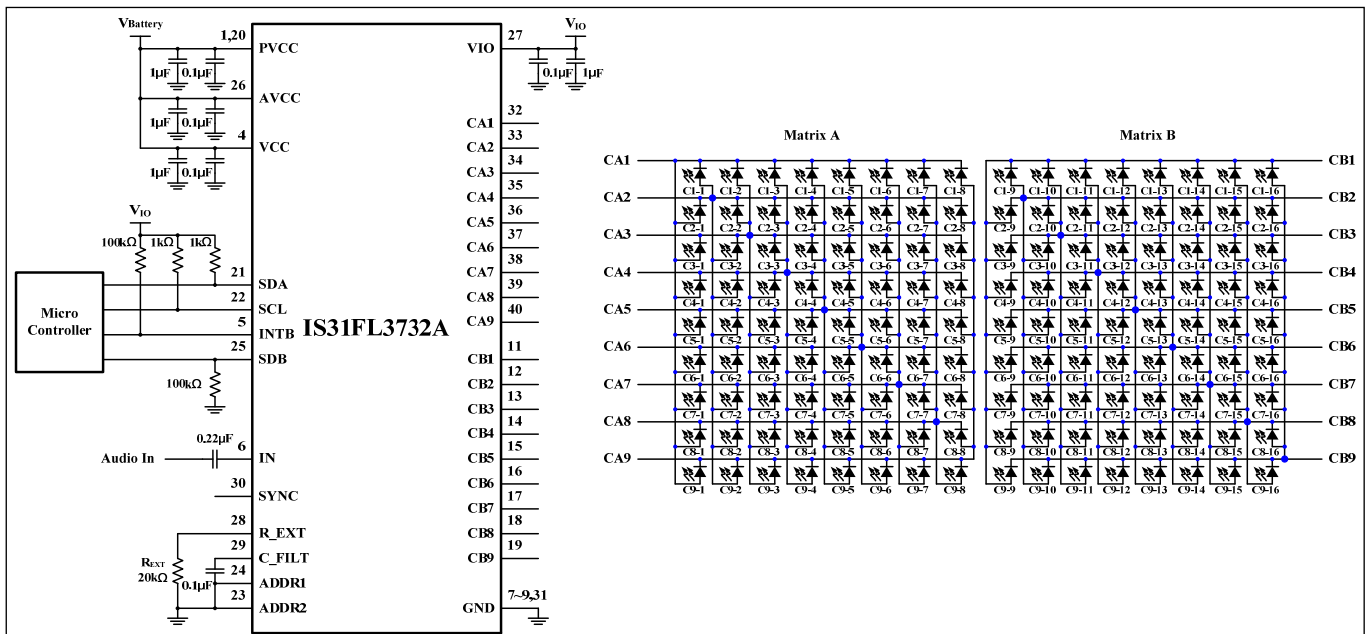

Figure 1 Typical Application Circuit

**Note 1:** For the mobile applications the IC should be placed far away from the mobile antenna in order to prevent the EMI.

**Note 2:** The average current of each LED is 3.2mA when  $R_{EXT} = 20k\Omega$ . The LED current can be modulated by the  $R_{EXT}$ . Please refer to the detail information in Page 18.

**Note 3:** The thermal pad should be connected to GND.

**Note 4:** The  $V_{IO}$  should be  $1.8V \leq V_{IO} \leq V_{CC}$ . And it is recommended to be equal to  $V_{OH}$  of the micro controller. For example, if  $V_{OH} = 1.8V$ , set  $V_{IO} = 1.8V$  is recommended.



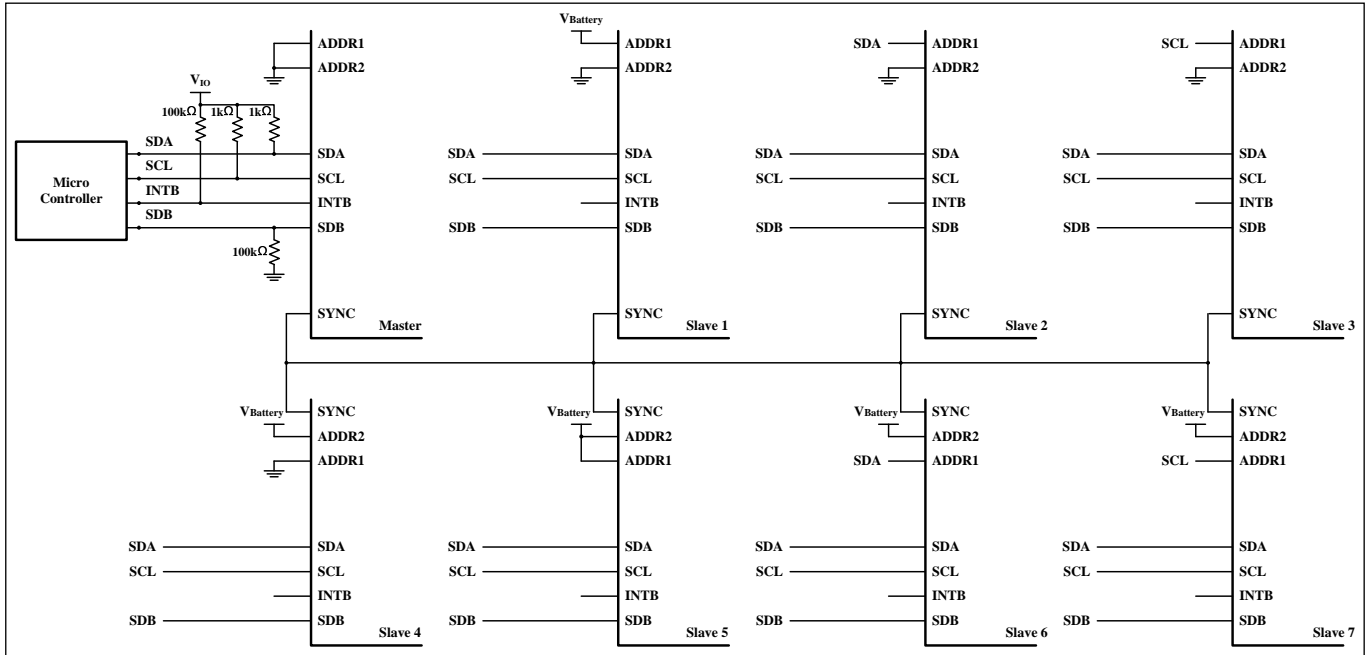
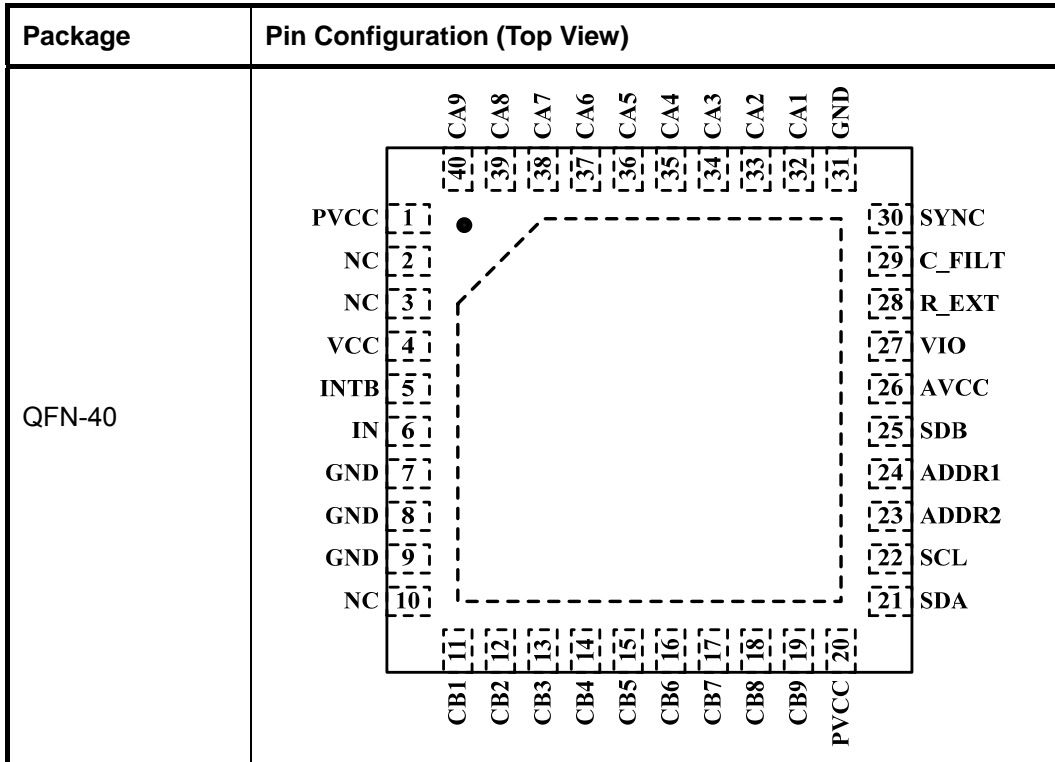

**Figure 3** Typical Application Circuit (Eight Parts Synchronization-Work)

**Note 5:** One part is configured as master, all the other 7 parts configured as slave. Work as master or slave specified by Configuration Register (Function register, 00h), and the detail described in Page 14. Master part output master clock, and all the other parts which work as slave input this master clock. The master clock is used for all parts which are connected synchronize Breath /Blink/ Auto Frame Play Mode related timing spec.

# IS31FL3732A

## PIN CONFIGURATION



# IS31FL3732A

## PIN DESCRIPTION

No.	Pin	Description
1,20	PVCC	Power supply for internal power block.
2,3,10	NC	Not connect.
4	VCC	Digital power supply
5	INTB	Interrupt output. Active low when movie end in Auto Frame Play Mode. Detail information refers to Page 19.
6	IN	Audio input.
7~9,31	GND	Digital ground.
11~19	CB1 ~ CB9	LED Matrix B current output/input port.
21	SDA	I2C compatible serial data.
22	SCL	I2C compatible serial clock.
23	ADDR2	I2C address 2 setting.
24	ADDR1	I2C address 1 setting.
25	SDB	Shutdown the chip when pull to low.
26	AVCC	Analog power supply.
27	VIO	Input logic reference voltage.
28	R_EXT	Input terminal used to connect an external resistor. This regulates the global output current. Detail information refers to Page 18.
29	C_FILT	Filter capacitor for audio control.
30	SYNC	Synchronize signal. It is used for more than one part work synchronize. Detail information refers to Page 20. If it is not used please float this pin.
32~40	CA1 ~ CA9	LED Matrix A current output/input port.
	Thermal Pad	Connect to GND.



# IS31FL3732A

---

## ORDERING INFORMATION

Industrial Range: -40°C to +85°C

---

Order Part No.	Package	QTY/Reel
IS31FL3732A-QFLS2-TR	QFN-40, Lead-free	2500

---

Copyright © 2017 Integrated Silicon Solution, Inc. All rights reserved. ISSI reserves the right to make changes to this specification and its products at any time without notice. ISSI assumes no liability arising out of the application or use of any information, products or services described herein. Customers are advised to obtain the latest version of this device specification before relying on any published information and before placing orders for products. Integrated Silicon Solution, Inc. does not recommend the use of any of its products in life support applications where the failure or malfunction of the product can reasonably be expected to cause failure of the life support system or to significantly affect its safety or effectiveness. Products are not authorized for use in such applications unless Integrated Silicon Solution, Inc. receives written assurance to its satisfaction, that:

- a.) the risk of injury or damage has been minimized;
- b.) the user assume all such risks; and
- c.) potential liability of Integrated Silicon Solution, Inc is adequately protected under the circumstances

# IS31FL3732A

## ABSOLUTE MAXIMUM RATINGS

Supply voltage, $V_{CC}$	-0.3V ~ +6.0V
Voltage at any input pin	-0.3V ~ $V_{CC}+0.3V$
Maximum junction temperature, $T_{JMAX}$	150°C
Storage temperature range, $T_{STG}$	-65°C ~ +150°C
Operating temperature range, $T_A=T_J$	-40°C ~ +85°C
Thermal resistance, junction to ambient, $\theta_{JA}$	24.96°C/W
ESD (HBM)	±8kV
ESD (CDM)	±1kV

### Note:

Stresses beyond those listed under "Absolute Maximum Ratings" may cause permanent damage to the device. These are stress ratings only and functional operation of the device at these or any other condition beyond those indicated in the operational sections of the specifications is not implied. Exposure to absolute maximum rating conditions for extended periods may affect device reliability.

## ELECTRICAL CHARACTERISTICS

The following specifications apply for  $V_{CC} = 3.6V$ ,  $T_A = 25^\circ C$ , unless otherwise noted.

Symbol	Parameter	Conditions	Min.	Typ.	Max.	Unit
$V_{CC}$	Supply voltage		2.7		5.5	V
$I_{CC}$	Quiescent power supply current	Picture Mode, all LEDs off		2.17		mA
$I_{SD}$	Shutdown current	$V_{SDB} = 0V$		0.1	1	$\mu A$
		$V_{SDB} = V_{CC}$ , Software Shutdown 1 Function Register 0Ah written "0000 0000".		370		
		$V_{SDB} = V_{CC}$ , Software Shutdown 2 Function Register 0Ah written "0000 0010".		3		
$I_{OUT}$	Output DC current of CA1~CA9,CB1~CB9	Matrix display mode without audio modulation (Note 1)		34		mA
$V_{HR}$	Current sink headroom voltage C1~C9	$I_{SINK} = 270mA$ (Note 1, 2)		350		mV
	Current source headroom voltage C1~C9	$I_{SOURCE} = 34mA$ (Note 1)		350		
$t_{SCAN}$	Period of scanning	(Figure 4)		43		$\mu s$
$t_{SCANOL}$	Non-overlap blanking time during scan	(Figure 4)		6		$\mu s$
$I_{LED}$	Average current of each LED	$R_{EXT} = 20k\Omega$ , PWM Register written "1111 1111" (Note 3)		3.2		mA

### Logic Electrical Characteristics (SDA, SCL, ADDR1, ADDR2, SYNC, SDB)

$V_{IL}$	Logic "0" input voltage	$V_{IO}=3.6V$	GND		$0.2V_{IO}$	V
$V_{IH}$	Logic "1" input voltage	$V_{IO}=3.6V$	$0.75V_{IO}$		$V_{IO}$	V
$V_{OL}$	Logic "0" output voltage for SYNC	$I_{OL} = 8mA$			0.4	V
$V_{OH}$	Logic "1" output voltage for SYNC	$I_{OH} = 8mA$	$0.75V_{IO}$			V
$I_{IL}$	Logic "0" input current	$V_{INPUT} = 0V$ (Note 4)		5		nA
$I_{IH}$	Logic "1" input current	$V_{INPUT} = V_{IO}$ (Note 4)		5		nA

# IS31FL3732A

## DIGITAL INPUT SWITCHING CHARACTERISTICS (Note 4)

Symbol	Parameter	Fast Mode			Fast Mode Plus			Units
		Min.	Typ.	Max.	Min.	Typ.	Max.	
$f_{SCL}$	Serial-Clock frequency	-		400	-		1000	kHz
$t_{BUF}$	Bus free time between a STOP and a START condition	1.3		-	0.5		-	$\mu$ s
$t_{HD, STA}$	Hold time (repeated) START condition	0.6		-	0.26		-	$\mu$ s
$t_{SU, STA}$	Repeated START condition setup time	0.6		-	0.26		-	$\mu$ s
$t_{SU, STO}$	STOP condition setup time	0.6		-	0.26		-	$\mu$ s
$t_{HD, DAT}$	Data hold time	-		-	-		-	$\mu$ s
$t_{SU, DAT}$	Data setup time	100		-	50		-	ns
$t_{LOW}$	SCL clock low period	1.3		-	0.5		-	$\mu$ s
$t_{HIGH}$	SCL clock high period	0.7		-	0.26		-	$\mu$ s
$t_R$	Rise time of both SDA and SCL signals, receiving (Note 5)	-	$20+0.1C_b$	300	-	$20+0.1C_b$	120	ns
$t_F$	Fall time of both SDA and SCL signals, receiving (Note 5)	-	$20+0.1C_b$	300	-	$20+0.1C_b$	120	ns

**Note 1:** In case of  $R_{EXT} = 20k\Omega$ , Global Current Control Register (Function Register, 04h) written "1111 1111".

**Note 2:** All LEDs are on.

**Note 3:**  $I_{LED} = 680/(10.5 \times R_{EXT})$ ,  $R_{EXT} = 20k\Omega$  is recommended. The recommended minimum value of  $R_{EXT}$  is  $18k\Omega$ .  $I_{LED} = I_{OUT}/10.5$ . Global Current Control Register (Function Register, 04h) written "1111 1111".

**Note 4:** Guaranteed by design.

**Note 5:**  $C_b = C_{I2C} + C_W$ , where  $C_W$  is the parasitic capacitance of SDA/SCL PCB wire and  $C_{I2C}$  (2pF, Typ.) is the capacitance of SDA or SCL pins.  $t_R$  and  $t_F$  measured between  $0.3 \times V_{IO}$  and  $0.7 \times V_{IO}$  and  $I_{SINK} \leq 6mA$ .

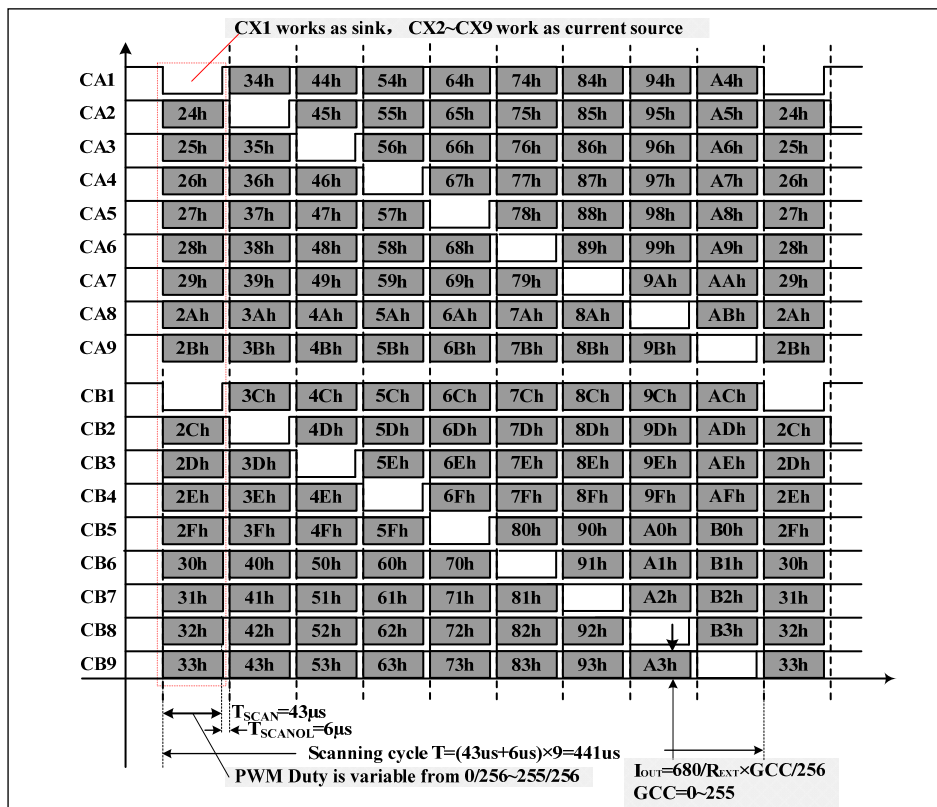

Figure 4 Scanning Timing



# IS31FL3732A

## DETAILED DESCRIPTION

### I2C INTERFACE

The IS31FL3732A uses a serial bus, which conforms to the I2C protocol, to control the chip's functions with two wires: SCL and SDA. The IS31FL3732A has a 7-bit slave address (A7:A1), followed by the R/W bit, A0. Set A0 to "0" for a write command and set A0 to "1" for a read command. The value of bits A1 and A2 are decided by the connection of the ADDR1 pin. The value of bits A3 and A4 are decided by the connection of the ADDR2 pin.

The complete slave address is:

**Table 1 Slave Address:**

ADDR2	ADDR1	A7:A5	A4:A3	A2:A1	A0
GND	GND	101	00	00	0/1
GND	SCL		00	01	
GND	SDA		00	10	
GND	VCC		00	11	
SCL	GND		01	00	
SCL	SCL		01	01	
SCL	SDA		01	10	
SCL	VCC		01	11	
SDA	GND		10	00	
SDA	SCL		10	01	
SDA	SDA		10	10	
SDA	VCC		10	11	
VCC	GND		11	00	
VCC	SCL		11	01	
VCC	SDA		11	10	
VCC	VCC		11	11	

ADDR1/2 connected to GND, (A2:A1)/(A4:A3)=00;

ADDR1/2 connected to VCC, (A2:A1)/(A4:A3)=11;

ADDR1/2 connected to SCL, (A2:A1)/(A4:A3)=01;

ADDR1/2 connected to SDA, (A2:A1)/(A4:A3)=10;

The SCL line is uni-directional. The SDA line is bi-directional (open-collector) with a pull-up resistor (typically 1kΩ). The maximum clock frequency specified by the I2C standard is 1MHz. In this discussion, the master is the microcontroller and the slave is the IS31FL3732A.

The timing diagram for the I2C is shown in Figure 5. The SDA is latched in on the stable high level of the SCL. When there is no interface activity, the SDA line should be held high.

The "START" signal is generated by lowering the SDA signal while the SCL signal is high. The start signal will alert all devices attached to the I2C bus to check the incoming address against their own chip address.

The 8-bit chip address is sent next, most significant bit first. Each address bit must be stable while the SCL level is high.

After the last bit of the chip address is sent, the master checks for the IS31FL3732A's acknowledge. The master releases the SDA line high (through a pull-up resistor). Then the master sends an SCL pulse. If the IS31FL3732A has received the address correctly, then it holds the SDA line low during the SCL pulse. If the SDA line is not low, then the master should send a "STOP" signal (discussed later) and abort the transfer.

Following acknowledge of IS31FL3732A, the register address byte is sent, most significant bit first. IS31FL3732A must generate another acknowledge indicating that the register address has been received.

Then 8-bit of data byte are sent next, most significant bit first. Each data bit should be valid while the SCL level is stable high. After the data byte is sent, the IS31FL3732A must generate another acknowledge to indicate that the data was received.

The "STOP" signal ends the transfer. To signal "STOP", the SDA signal goes high while the SCL signal is high.

### ADDRESS AUTO INCREMENT

To write multiple bytes of data into IS31FL3732A, load the address of the data register that the first data byte is intended for. During the IS31FL3732A acknowledge of receiving the data byte, the internal address pointer will increment by one. The next data byte sent to IS31FL3732A will be placed in the new address, and so on. The auto increment of the address will continue as long as data continues to be written to IS31FL3732A (Figure 8).

### READING OPERATION

All of registers in IS31FL3732A can be read except Command Register (FDh). The Frame Register can only be read in Software Shutdown 1 as SDB pin is high. And the Function Register can be read in all modes.

To read the device data, the bus master must first send the IS31FL3732A address with the  $R/\bar{W}$  bit set to "0", followed by the Command Register (FDh) then send command data which determines which response register is accessed. After a restart, the bus master must send the IS31FL3732A address with the  $R/\bar{W}$  bit set to "0" again, followed by the register address which determines which register is accessed. Then restart I2C, the bus master should send the IS31FL3732A address with the  $R/\bar{W}$  bit set to "1". Data from the register defined by the command byte is then sent from the IS31FL3732A to the master (Figure 9).

# IS31FL3732A

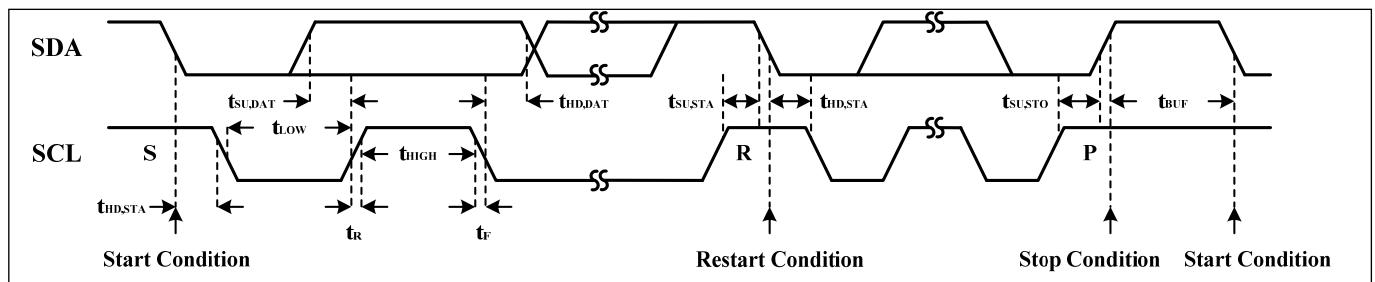

Figure 5 Interface Timing

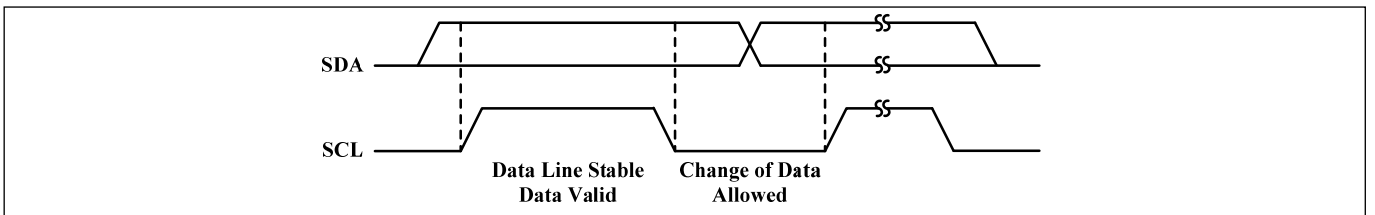

Figure 6 Bit Transfer

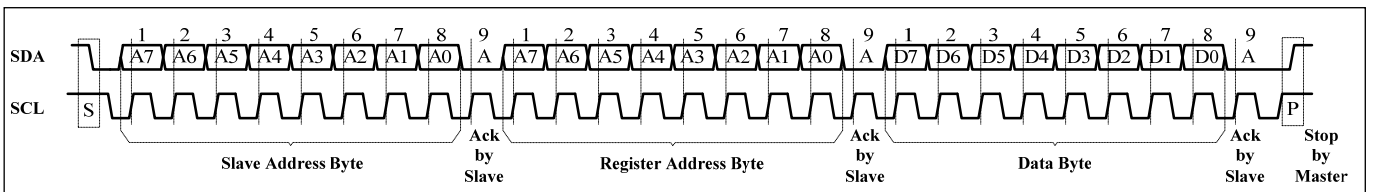

Figure 7 Writing to IS31FL3732A (Typical)

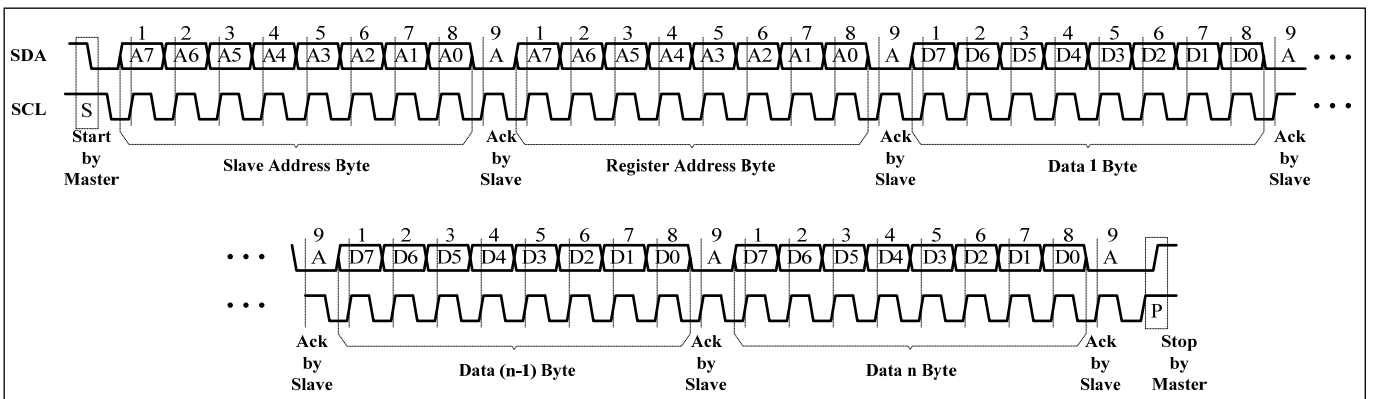

Figure 8 Writing to IS31FL3732A (Automatic Address Increment)

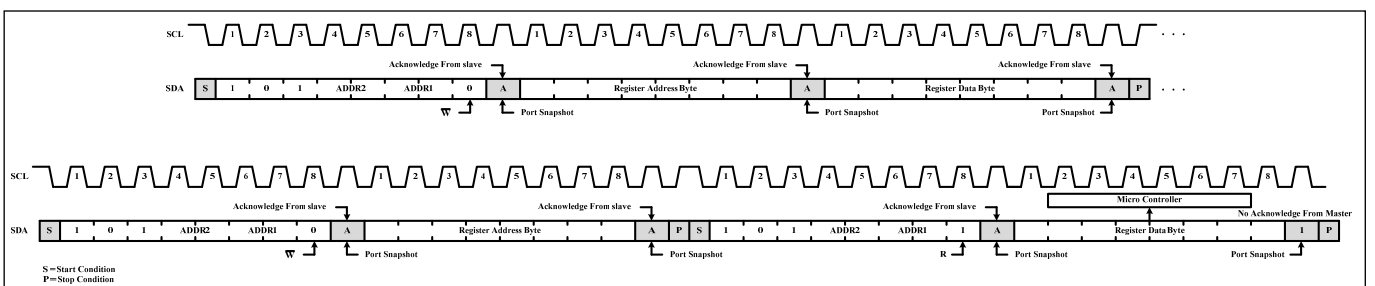

Figure 9 Reading from IS31FL3732A

# IS31FL3732A

## REGISTER DEFINITION

**Table 2 FDh Command Register (Write Only)**

Data	Function	Data	Function
0000 0000	Point to Page One (Frame 1 Register is available)	0000 0001	Point to Page Two (Frame 2 Register is available)
0000 0010	Point to Page Three (Frame 3 Register is available)	0000 0011	Point to Page Four (Frame 4 Register is available)
0000 0100	Point to Page Five (Frame 5 Register is available)	0000 0101	Point to Page Six (Frame 6 Register is available)
0000 0110	Point to Page Seven (Frame 7 Register is available)	0000 0111	Point to Page Eight (Frame 8 Register is available)
0000 1011	Point to Page Nine (Function Register is available)	Others	Reserved

**Note:** The Command Register should be configured first after writing in the slave address to choose the available register (Frame Register and Function Register). Then write data in the choosing register. Power up default state is "0000 0000".

For example, when write "0000 0011" in the Command Register (FDh), the data which writing after will be stored in the Frame 4 Register. Write new data can configure other registers.

**Table 3 Response Register Function**

**(The address of each Page is starting from 00h. Frame Registers have the same format.)**

Address	Name	Function	Table	R/W	Default
<b>Frame Register (Page One to Page Eight) (Note 6)</b>					
00h ~ 11h	LED Control Register	Store on or off state for each LED	4	R/W	xxxx xxxx
12h ~ 23h	Blink Control Register	Control the blink function for each LED	5	R/W	
24h ~ B3h	PWM Register	144 LEDs PWM duty cycle data register	6	R/W	
<b>Function Register (Page Night) (Note 7)</b>					
00h	Configuration Register	Configure the operation mode	8	R/W	0000 0000
01h	Picture Display Register	Set the display frame in Picture Mode	9	R/W	
02h	Auto Play Control Register 1	Set the way of display in Auto Frame Play Mode	10	R/W	
03h	Auto Play Control Register 2	Set the delay time in Auto Frame Play Mode	11	R/W	
04h	Global Current Control	Set the global current for all LEDs	12	R/W	
05h	Display Option Register	Set the display option	13	R/W	
06h	Audio Synchronization Register	Set audio synchronization function	14	R/W	
07h	Frame State Register	Store the frame display information	15	R	
08h	Breath Control Register 1	Set fade in and fade out time for breath function	16	R/W	
09h	Breath Control Register 2	Set the breath function	17	R/W	
0Ah	Shutdown Register	Set software shutdown mode	18	R/W	
0Bh	AGC Control Register	Set the AGC function and the audio gain.	19	R/W	
0Ch	Audio ADC Rate Register	Set the ADC sample rate of the input signal	20	R/W	

**Note 6:** The data of Frame Registers are random after power up. Please initialize the Frame Registers first to ensure operate normally. Frame Register writing operation must be in case of SDB pin high and Function Register (0Ah) written "0000 0000" (Software Shutdown 1) or "0000 0001" (Normal operation). Read operation asks for SDB pin high and Function Register (0Ah) written "0000 0000" (Software Shutdown 1). Due to max address of Frame Registers is B3h, value '110' and '111' are prohibited for Frame Register address 3 MSB.

**Note 7:** Function registers can be written and read after power up. All function registers power up default state are '0000 0000', once V<sub>CC</sub> drop to 1.75V (typical) all function registers are reset to their default state in case of SDB pin pulled high.

# IS31FL3732A

## REGISTER CONTROL

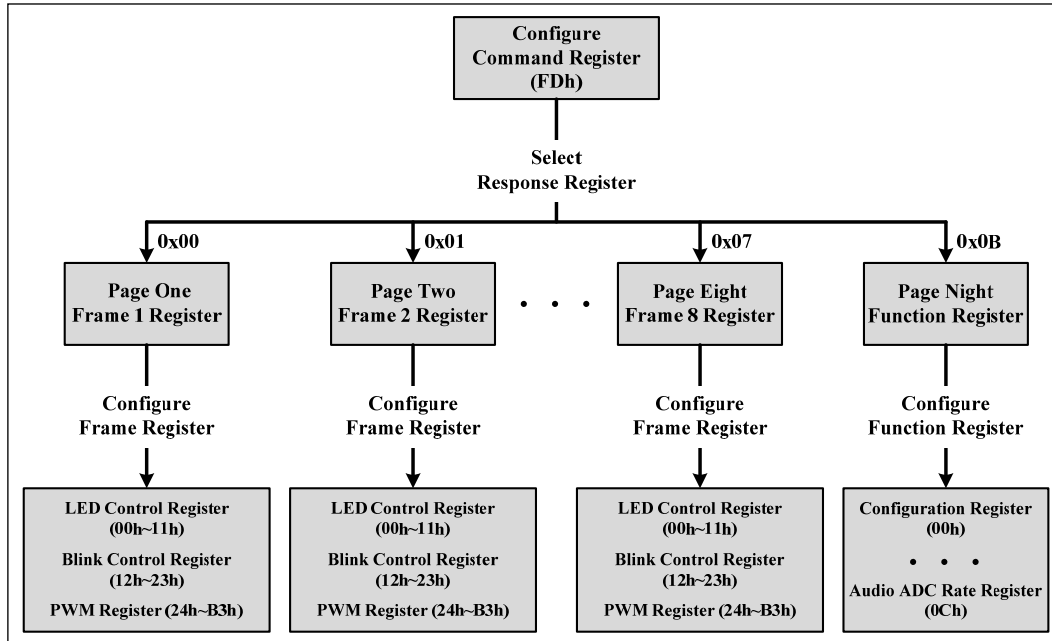

For example, if write “0000 0001” into Command Register (FDh), it means choosing Page Two Frame 2 Register to configure. Then next address and data will take effect only for Frame 2 Register unless re-configure Command Register (FDh).

### FRAME REGISTER

**Table 4 00h ~ 11h LED Control Register**

Bit	D7:D0
Name	$C_{X-8} : C_{X-1}$ or $C_{X-16} : C_{X-9}$
Default	xxxx xxxx

The LED Control Registers store the on or off state of each LED in the Matrix A and B. Please refer to the detail information in Table 7.

$C_{X-Y}$	LED State Bit
0	LED off
1	LED on

Figure 10 in Page 13 shows the ordering of  $C_{X-Y}$ .

**Table 5 12h ~ 23h Blink Control Register**

Bit	D7:D0
Name	$C_{X-8} : C_{X-1}$ or $C_{X-16} : C_{X-9}$
Default	xxxx xxxx

The Blink Control Registers configure the blink function of each LED in the Matrix A and B. Please refer to the detail information in Table 7.

$C_{X-Y}$	Blink Control Bit
0	Disable
1	Enable

Figure 10 in Page 13 shows the ordering of  $C_{X-Y}$ .

**Table 6 24h ~ B3h PWM Register**

Bit	D7:D0
Name	PWM
Default	xxxx xxxx

PWM Registers modulate the 144 LEDs average current in 256 steps.

The value of the PWM Registers decides the output average current of each LED noted  $I_{LED}$ .

$I_{LED}$  computed by Formula (1):

$$I_{LED} = \frac{PWM}{256} \times I_{OUT} \times \frac{1}{10.5} \quad (1)$$

$$PWM = \sum_{n=0}^7 D[n] \cdot 2^n$$

Where  $D[n]$  stands for the individual bit value, 1 or 0, in location  $n$ .

For example: if  $D7:D0 = 10110101$ ,

$$I_{LED} = \frac{2^0 + 2^2 + 2^4 + 2^5 + 2^7}{256} \times I_{OUT} \times \frac{1}{10.5}$$

$I_{OUT}$  is output DC current which can be set by the GCC bit of Global Current Control Register (04h) and  $R_{EXT}$ . Detail information refers to Table 12 in Page 15.

# IS31FL3732A

**Table 7 Address of Frame Register**

LED Location		LED Control Register		Blink Control Register		PWM Register	
Matrix A	Matrix B	Matrix A	Matrix B	Matrix A	Matrix B	Matrix A	Matrix B
CA1(C <sub>1-1</sub> ~C <sub>1-8</sub> )	CB1(C <sub>1-9</sub> ~C <sub>1-16</sub> )	00h	01h	12h	13h	24h ~ 2Bh	2Ch ~ 33h
CA2(C <sub>2-1</sub> ~C <sub>2-8</sub> )	CB2(C <sub>2-9</sub> ~C <sub>2-16</sub> )	02h	03h	14h	15h	34h ~ 3Bh	3Ch ~ 43h
CA3(C <sub>3-1</sub> ~C <sub>3-8</sub> )	CB3(C <sub>3-9</sub> ~C <sub>3-16</sub> )	04h	05h	16h	17h	44h ~ 4Bh	4Ch ~ 53h
CA4(C <sub>4-1</sub> ~C <sub>4-8</sub> )	CB4(C <sub>4-9</sub> ~C <sub>4-16</sub> )	06h	07h	18h	19h	54h ~ 5Bh	5Ch ~ 63h
CA5(C <sub>5-1</sub> ~C <sub>5-8</sub> )	CB5(C <sub>5-9</sub> ~C <sub>5-16</sub> )	08h	09h	1Ah	1Bh	64h ~ 6Bh	6Ch ~ 73h
CA6(C <sub>6-1</sub> ~C <sub>6-8</sub> )	CB6(C <sub>6-9</sub> ~C <sub>6-16</sub> )	0Ah	0Bh	1Ch	1Dh	74h ~ 7Bh	7Ch ~ 83h
CA7(C <sub>7-1</sub> ~C <sub>7-8</sub> )	CB7(C <sub>7-9</sub> ~C <sub>7-16</sub> )	0Ch	0Dh	1Eh	1Fh	84h ~ 8Bh	8Ch ~ 93h
CA8(C <sub>8-1</sub> ~C <sub>8-8</sub> )	CB8(C <sub>8-9</sub> ~C <sub>8-16</sub> )	0Eh	0Fh	20h	21h	94h ~ 9Bh	9Ch ~ A3h
CA9(C <sub>9-1</sub> ~C <sub>9-8</sub> )	CB9(C <sub>9-9</sub> ~C <sub>9-16</sub> )	10h	11h	22h	23h	A4h ~ ABh	ACh ~ B3h

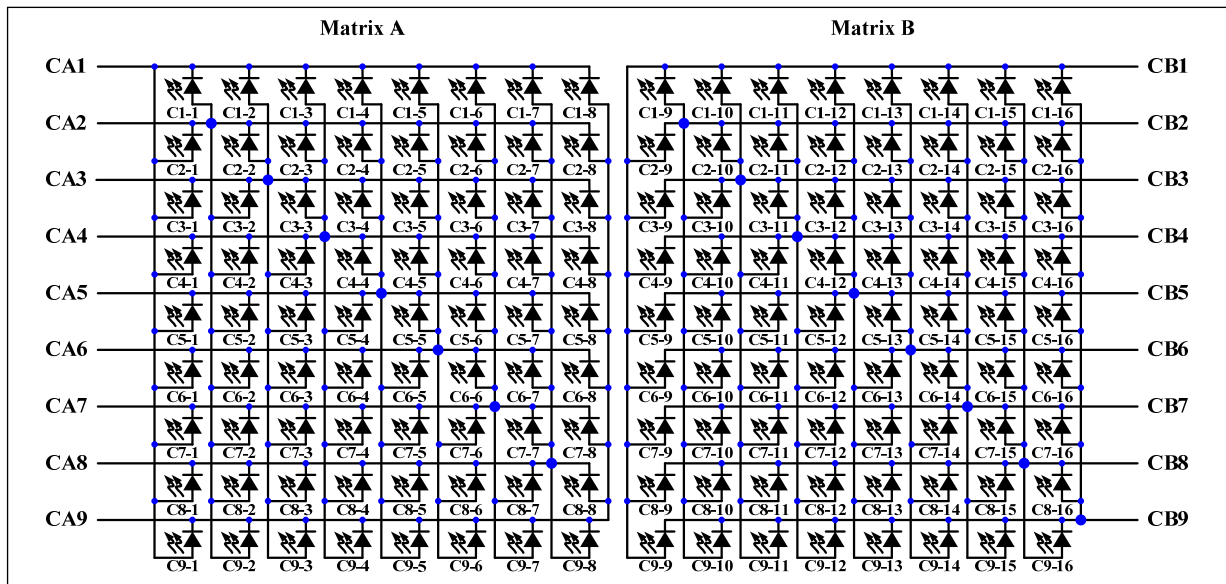

**Figure 10 LED Array**

# IS31FL3732A

## FUNCTION REGISTER

**Table 8 00h Configuration Register**

Bit	D7:D6	D5	D4:D3	D2:D0
Name	SYNC	-	MODE	FS
Default	00	0	00	000

The Configuration Register sets operating mode of IS31FL3732A.

**SYNC** Synchronize Configuration

- 00/11 High Impedance
- 01 Master
- 10 Slave

**MODE** Display Mode

- 00 Picture Mode
- 01 Auto Frame Play Mode
- 10 Audio Frame Play Mode

**FS** Frame Start

(Available in Auto Frame Play Mode)

- 000 Frame 1
- 001 Frame 2
- 010 Frame 3
- 011 Frame 4
- 100 Frame 5
- 101 Frame 6
- 110 Frame 7
- 111 Frame 8

FS bit sets the start frame in Auto Frame Play Mode. Movie starts from Frame 4 when the FS bit is set to "011". The FS bit is only available in Auto Frame Play Mode.

**Table 9 01h Picture Display Register**

Bit	D7:D3	D2:D0
Name	-	PFS
Default	00000	000

The Picture Display Register sets display frame in Picture Mode.

**PFS** Picture Frame Selection  
(Available in Picture Mode)

- 000 Frame 1
- 001 Frame 2
- 010 Frame 3
- 011 Frame 4
- 100 Frame 5
- 101 Frame 6
- 110 Frame 7
- 111 Frame 8

**Table 10 02h Auto Play Control Register 1**

Bit	D7	D6:D4	D3	D2:D0
Name	-	CNS	-	FNS
Default	0	000	0	000

The Auto Play Control Register 1 sets the way of display in Auto Frame Play Mode.

**CNS** Number of Loops Playing Selection  
(Available in Auto Frame Play Mode)

- 000 Play endless
- 001 1 loop
- 010 2 loops
- 011 3 loops
- 100 4 loops
- 101 5 loops
- 110 6 loops
- 111 7 loops

**FNS** Number of Frames Playing Selection  
(Available in Auto Frame Play Mode)

- 000 All Frame
- 001 1 frame
- 010 2 frames
- 011 3 frames
- 100 4 frames
- 101 5 frames
- 110 6 frames
- 111 7 frames

Movie will be stop in the next frame of the cycle. For example, FS bit is set to "011", CNS bit is set to "011" and FNS bit is set to "011". Then the movie will play from Frame 4 to Frame 6 and play three times it stops in Frame 7.

# IS31FL3732A

**Table 11 03h Auto Play Control Register 2**

Bit	D7:D6	D5:D0
Name	-	A
Default	00	000000

The Auto Play Control Register 2 sets the delay time in Auto Frame Play Mode (Figure 14).

**FDT** Frame Delay Time  
(Available in Auto Frame Play Mode)

If A = 0, FDT =  $\tau \times 64$ ;

If A = 1~63, FDT =  $\tau \times A$ ;

A = 0~63 and  $\tau = 8.8\text{ms}$  (Typ.);

For example, when A = 20, FDT is  $8.8\text{ms} \times 20 = 176\text{ms}$

**Table 12 04h Global Current Control Register**

Bit	D7:D0
Name	GCC
Default	0000 0000

The Global Current Control Register modulates all LEDs DC current which is noted as  $I_{OUT}$  in 256 steps.

$I_{OUT}$  is computed by the Formula (2):

$$I_{OUT} = \frac{GCC}{256} \times \frac{680}{R_{EXT}} \quad (2)$$

$$GCC = \sum_{n=0}^7 D[n] \cdot 2^n$$

Where D[n] stands for the individual bit value, 1 or 0, in location n.

For example: if D7:D0 = 10110101,

$$I_{OUT} = \frac{2^0 + 2^2 + 2^4 + 2^5 + 2^7}{256} \times \frac{680}{R_{EXT}}$$

$R_{EXT}$  is the external resistor to set DC current, detail information please refers to Page 18.

**Table 13 05h Display Option Register**

Bit	D7:D6	D5	D4	D3	D2:D0
Name	-	IC	-	BE	A
Default	00	0	0	0	000

The Display Option Register sets display option of IS31FL3732A.

**IC** Intensity Control  
0 Set the intensity of each frame independently  
1 Use intensity setting of frame 1 for all other frames

**BE** Blink Enable  
0 Disable  
1 Enable

**BPT** Blink Period Time

$BPT = \tau \times A$ ;

A = 0~7,  $\tau = 0.21\text{s}$  (Typ.);

For example, when A = 5, BPT is  $0.21\text{s} \times 5 = 1.05\text{s}$ .

The duty cycle for blink function is 50%.

**Table 14 06h Audio Synchronization Register**

Bit	D7:D1	D0
Name	-	AE
Default	0000000	0

The Audio Synchronization Register sets audio synchronization function.

**AE** Audio Synchronization Enable  
0 Audio synchronization disable  
1 Enable audio signal to modulate the intensity of the matrix

The intensity of matrix can be modulated by the audio input signal basing on each LED's current is set by PWM when the AE bit is set to "1".

**Table 15 07h Frame State Register (Read Only)**

Bit	D7:D5	D4	D3	D2:D0
Name	-	INT	-	CFD
Default	-			

The Frame State Register stores the frame display information.

**INT** Interrupt Bit  
(Available in Auto Frame Play Mode)  
0 Movie has not finished  
1 Movie has finished

**CFD** Current Frame Display  
000 Frame 1  
001 Frame 2  
010 Frame 3  
011 Frame 4  
100 Frame 5  
101 Frame 6  
110 Frame 7  
111 Frame 8

The INT bit will be set to "1" automatically when movie is end in Auto Frame Play Mode. The INT bit can be cleared up by reading the Frame State Register.



# IS31FL3732A

**Table 16 08h Breath Control Register 1**

Bit	D7	D6:D4	D3	D2:D0
Name	-	A	-	B
Default	0	000	0	000

The Breath Control Register 1 sets fade in and fade out time for breath function.

**FOT** Fade Out Time

$$FOT = \tau \times 2^A$$

A = 0~7,  $\tau = 20.8\text{ms}$  (Typ.)

For example, when A = 4, FOT is  $20.8\text{ms} \times 2^4 = 332.8\text{ms}$

**FIT** Fade In Time

$$FIT = \tau \times 2^B$$

B = 0~7,  $\tau = 20.8\text{ms}$  (Typ.)

For example, when A = 4, FIT is  $20.8\text{ms} \times 2^4 = 332.8\text{ms}$

**Table 17 09h Breath Control Register 2**

Bit	D7:D5	D4	D3	D2:D0
Name	-	B_EN	-	A
Default	000	0	0	000

The Breath Control Register 2 sets the breath function.

**B\_EN** Breath Enable

(Available in Picture Mode and Auto Frame Play Mode)

0 Disable  
1 Enable

**ET** Extinguish Time

$$ET = \tau \times 2^A$$

A = 0~7,  $\tau = 2.8\text{ms}$  (Typ.)

For example, when A = 4, ET is  $2.8\text{ms} \times 2^4 = 44.8\text{ms}$

**Table 18 0Ah Shutdown Register**

Bit	D7:D2	D1:D0
Name	-	SSD
Default	000000	00

The Shutdown Register sets software shutdown.

**SSD** Software Shutdown Control

00 Software Shutdown 1  
01 Normal Operation  
1x Software Shutdown 2

Frame Register and Function Register all can be written and read during Software Shutdown 1. Frame Register cannot be written during Software Shutdown 2.

**Table 19 0Bh AGC Control Register**

Bit	D7:D5	D4	D3	D2:D0
Name	-	AGCM	AGC	AGS
Default	000	0	0	000

The AGC Control Register sets the AGC function and the audio gain.

**AGCM** AGC Mode

0 Slow Mode  
1 Fast Mode

**AGC** AGC Enable

0 Disable  
1 Enable

**AGS** Audio Gain Selection

000 0dB  
001 3dB  
010 6dB  
011 9dB  
100 12dB  
101 15dB  
110 18dB  
111 21dB

The AGS bit is available in Audio Frame Play Mode and audio synchronization mode.

**Table 20 0Ch Audio ADC Rate Register**

Bit	D7:D0
Name	A
Default	0000 0000

The Audio ADC Rate Register sets the ADC sample rate of the input signal in Audio Frame Play Mode.

**AAR** Audio ADC Rate

(Available in Audio Frame Play Mode)

If A = 0, AAR =  $\tau \times 256$

If A = 1~255, AAR =  $\tau \times A$

$\tau = 36.8\mu\text{s}$  (Typ.)

For example, when A = 10, AAR is  $36.8\mu\text{s} \times 10 = 368\mu\text{s}$



# IS31FL3732A

## FUNCTIONAL BLOCK DIAGRAM

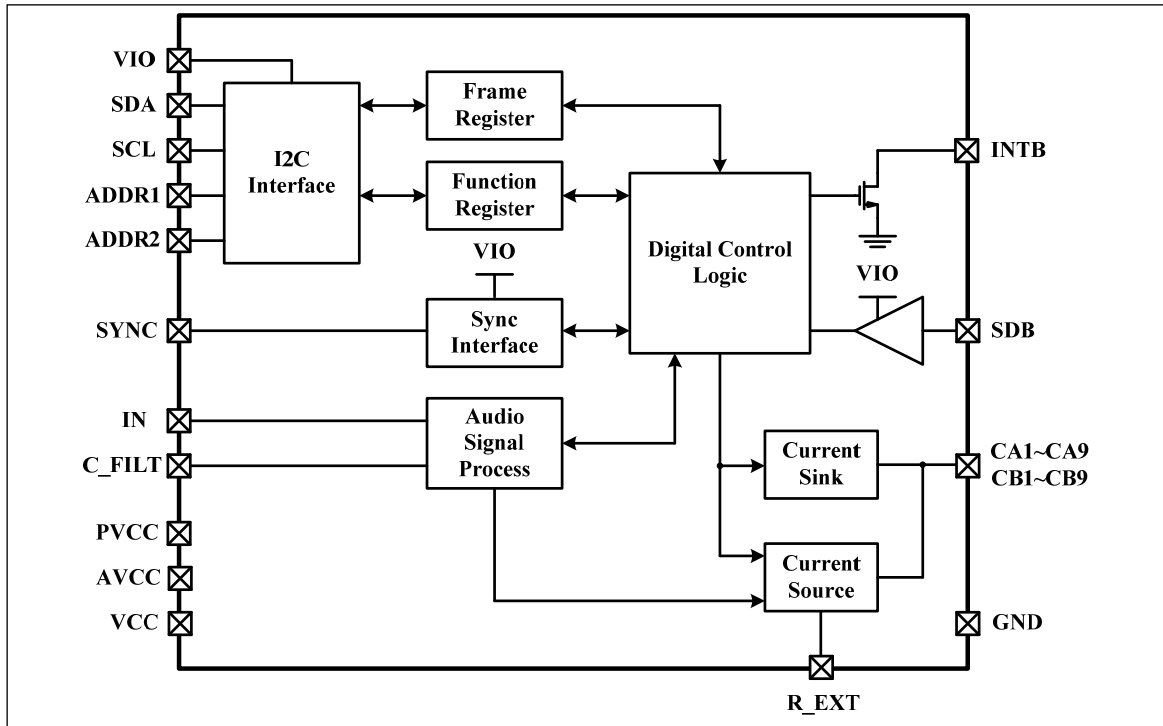

# IS31FL3732A

**APPLICATION INFORMATION (The description below is for the Function Register unless otherwise noted.)**

## PWM CONTROL

The brightness of 144 LEDs can be modulated with 256 steps by PWM Register. For example, if the data in PWM Register is “0000 0100”, then the PWM is the fourth step.

Writing new data continuously to the registers can modulate the brightness of the LEDs to achieve a breathing effect.

## EXTERNAL RESISTOR (R<sub>EXT</sub>)

The average output current of each LED can be adjusted by the external resistor, R<sub>EXT</sub>, as described in Formula (3).

$$I_{LED} = \frac{PWM}{256} \times \frac{GCC}{256} \times \frac{680}{R_{EXT}} \times \frac{1}{10.5} \quad (3)$$

Where PWM is PWM Register (Frame Register, 04h~B3h) data showing in Page 12 Table 6, and GCC is Global Current Control Register (Function Register, 04h) data showing in Page 15 Table 12.

For example, in Figure 1, R<sub>EXT</sub> = 20kΩ,

And PWM=255, GCC=255.

$$\text{So } I_{LED} = \frac{255}{256} \times \frac{255}{256} \times \frac{1}{10.5} \times \frac{680}{20k} = 3.21mA$$

The recommended minimum value of R<sub>EXT</sub> is 18kΩ.

## LED CURRENT (I<sub>LED</sub>)

The LED average current can be set by 3 factors:

1. R<sub>EXT</sub>, resistant which is connected R<sub>EXT</sub> pin and GND. R<sub>EXT</sub> set all LED DC current value.
2. Global Current Control Register (Function Register, 04h). This register control global current, set all LED DC current by 256 steps. Details refer to Page 15.
3. PWM Registers (Frame Register, 04h~B3h), every LED has an own PWM register. PWM Registers set individual LED current by 256 steps. Details refer to Page 12.

$$I_{LED} = \frac{PWM}{256} \times \frac{GCC}{256} \times \frac{680}{R_{EXT}} \times \frac{1}{10.5} \quad (3)$$

## GAMMA CORRECTION

In order to perform a better visual LED breathing effect we recommend using a gamma corrected PWM value to set the LED intensity. This results in a reduced number of steps for the LED intensity setting, but causes the change in intensity to appear more linear to the human eye.

Gamma correction, also known as gamma compression or encoding, is used to encode linear luminance to match the non-linear characteristics of

display. Since the IS31FL3732A can modulate the brightness of the LEDs with 256 steps, a gamma correction function can be applied when computing each subsequent LED intensity setting such that the changes in brightness matches the human eye's brightness curve.

**Table 21 32 Gamma Steps with 256 PWM Steps**

C(0)	C(1)	C(2)	C(3)	C(4)	C(5)	C(6)	C(7)
0	1	2	4	6	10	13	18
C(8)	C(9)	C(10)	C(11)	C(12)	C(13)	C(14)	C(15)
22	28	33	39	46	53	61	69
C(16)	C(17)	C(18)	C(19)	C(20)	C(21)	C(22)	C(23)
78	86	96	106	116	126	138	149
C(24)	C(25)	C(26)	C(27)	C(28)	C(29)	C(30)	C(31)
161	173	186	199	212	226	240	255

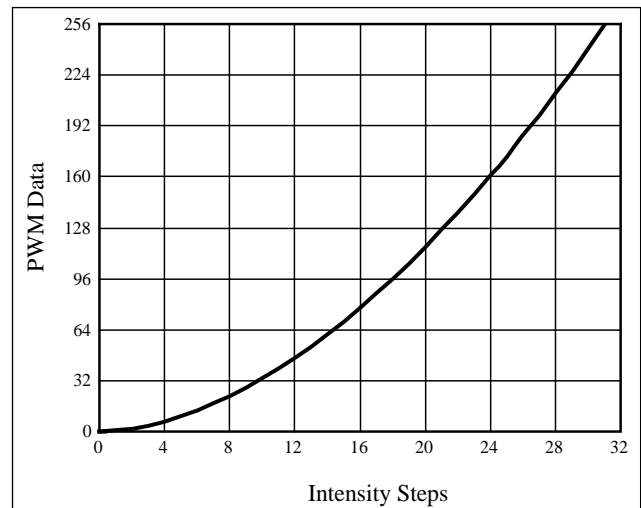

**Figure 11** Gamma Correction (32 Steps)

Choosing more gamma steps provides for a more continuous looking breathing effect. This is useful for very long breathing cycles. The recommended configuration is defined by the breath cycle T. When T=1s, choose 32 gamma steps, when T=2s, choose 64 gamma steps. The user must decide the final number of gamma steps not only by the LED itself, but also based on the visual performance of the finished product.

# IS31FL3732A

**Table 22 64 Gamma Steps with 256 PWM Steps**

C(0)	C(1)	C(2)	C(3)	C(4)	C(5)	C(6)	C(7)
0	1	2	3	4	5	6	7
C(8)	C(9)	C(10)	C(11)	C(12)	C(13)	C(14)	C(15)
8	10	12	14	16	18	20	22
C(16)	C(17)	C(18)	C(19)	C(20)	C(21)	C(22)	C(23)
24	26	29	32	35	38	41	44
C(24)	C(25)	C(26)	C(27)	C(28)	C(29)	C(30)	C(31)
47	50	53	57	61	65	69	73
C(32)	C(33)	C(34)	C(35)	C(36)	C(37)	C(38)	C(39)
77	81	85	89	94	99	104	109
C(40)	C(41)	C(42)	C(43)	C(44)	C(45)	C(46)	C(47)
114	119	124	129	134	140	146	152
C(48)	C(49)	C(50)	C(51)	C(52)	C(53)	C(54)	C(55)
158	164	170	176	182	188	195	202
C(56)	C(57)	C(58)	C(59)	C(60)	C(61)	C(62)	C(63)
209	216	223	230	237	244	251	255

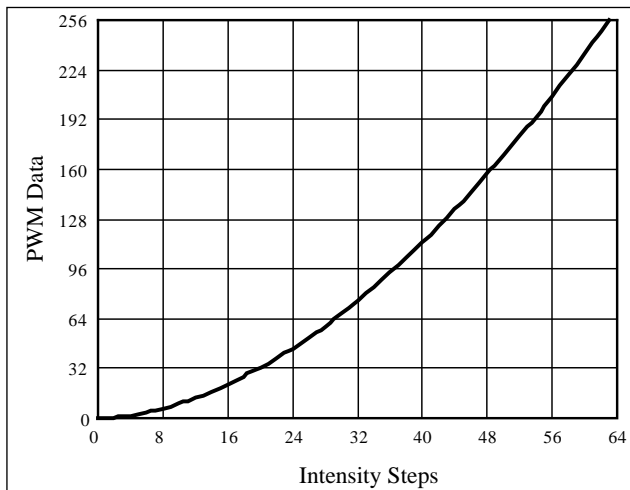

**Figure 12** Gamma Correction (64 Steps)

**Note:** The data of 32 gamma steps is the standard value and the data of 64 gamma steps is the recommended value.

## OPERATING MODE

IS31FL3732A has three operating modes, Picture Mode, Auto Frame Play Mode and Audio Frame Play Mode.

### PICTURE MODE

By setting the MODE bit of the Configuration Register (00h) to "00", the IS31FL3732A operates in Picture Mode. Set the PFS bit of Picture Display Register (01h) to choose the display frame. The Picture Mode can be operating with breath function by configuring Breath Control Register 2 (09h).

### AUTO FRAME PLAY MODE

By setting the MODE bit of the Configuration Register (00h) to "01", the IS31FL3732A operates in Auto Frame Play Mode. It stores data of 8 frames and automatically plays in order. Customers can configure

the delay time between each two frames and the first playing frame by setting the FS bit of Configuration Register (00h). The Auto Play Control Register 1 (02h) can configure the display cycle and display frames.

Configure the Auto Play Control Register 2 (03h), Breath Control Register 1 (08h) and Breath Control Register 2 (09h) can set the breath time between two frames switching.

### AUDIO FRAME PLAY MODE

By setting the MODE bit of the Configuration Register (00h) to "10", the IS31FL3732A operates in Audio Frame Play Mode. It stores data of 8 frames and the 8 frames playing follow the input signal. 0Ch register is used to set the ADC sample rate for the input signal to control frames playing. It plays the first frame when the value is the smallest and plays the eighth frame when the value is the biggest.

### AUDIO MODULATED AND GAIN SETTING

By setting the AE bit of the Audio Synchronization Register (06h) to "1", IS31FL3732A operates with audio synchronization. The intensity of LEDs is adjusted by the input signal. The audio input gain can be set by the AGC Control Register (0Bh).

### BLINK FUNCTION SETTING

By setting the BE bit of the Display Option Register (05h) to "1", blink function enable. If the BE bit is set to "1", each LED can be controlled by the Blink Control Registers (12h~23h in Page One to Page Eight). The Display Option Register (05h) is used to set the blink period time, BPT, and the duty cycle is 50% (Figure 13).

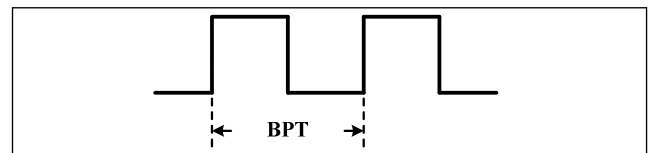

**Figure 13** Blink Function

### BREATHING FUNCTION SETTING

When IS31FL3732A switches playing frame, breath function is available. By setting the B\_EN bit of the Breath Control Register 2 (09h) to "1", breath function enable. When set the B\_EN bit to "0", breath function disables.

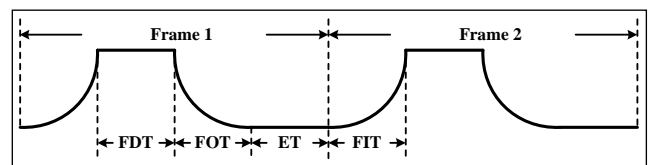

**Figure 14** Breathing Function

### INTERRUPT CONTROL

When IS31FL3732A is playing frame in the Auto Frame Play Mode, the INTB pin is high and the INT bit of Frame State Register (07h) is "0". It will be pulled

# IS31FL3732A

low as movie end and the INT bit will be set to “1” at the same time.

The INTB pin will be pulled high after reading Frame State Register (07h) operation or it will be pulled high automatically after it stays low for 7ms (Typ.). The INT bit will be reset to “0” only after reading Frame State Register (07h) operation.

## SYNCHRONIZE FUNCTION

SYNC bit of the Configuration Register (00h) sets SYNC pin input or output synchronize clock signal. It is used for more than one part working synchronize. When SYNC bit is set to “01”, SYNC pin output synchronize clock to synchronize other parts as master. When SYNC bit is set to “10”, SYNC pin input synchronize clock and work synchronization with this input signal as slave. When SYNC bit is set to “00/11”, SYNC pin is high impedance. Synchronize function is disabled. SYNC bit default state is “00” and SYNC pin is high impedance when power up.

## LED MATRIX CIRCUIT

The IS31FL3732A can drive 144 LEDs totally. Part of LEDs can if there is no need to use all 144 LEDs (Figure 15). But the LEDs which are no connected must be off by LED Control Register (Frame Register) or it will affect other LEDs.

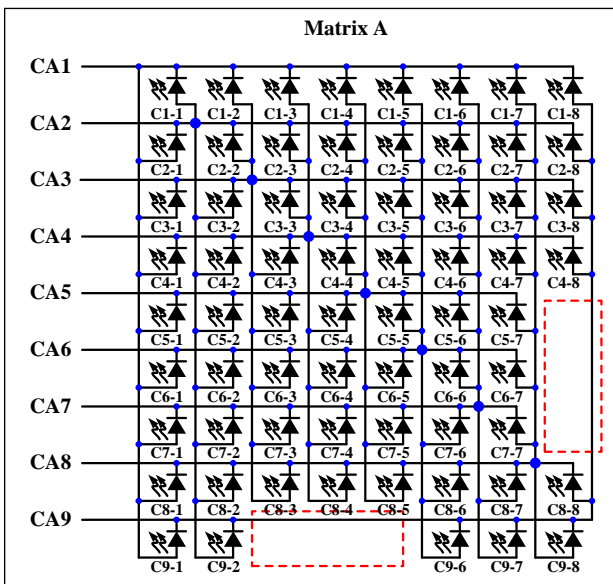

Figure 15 No C9-3~C9-5, C5-8~C9-8

## DRIVE RGBS MATRIX

The IS31FL3732A can drive 32 common cathode / common anode RGBs at best (Figure 16 and 17). The location of red LED must follow the below circuit and the black location could connect single LED except red one, or the IC can't work normally. As the lower  $V_F$  of red LED, diode should be used as below figures to prevent ghost issue when light the RGB.

Note, the LEDs which are no connected must be off by LED Control Register (Frame Register) or it will affect other LEDs.

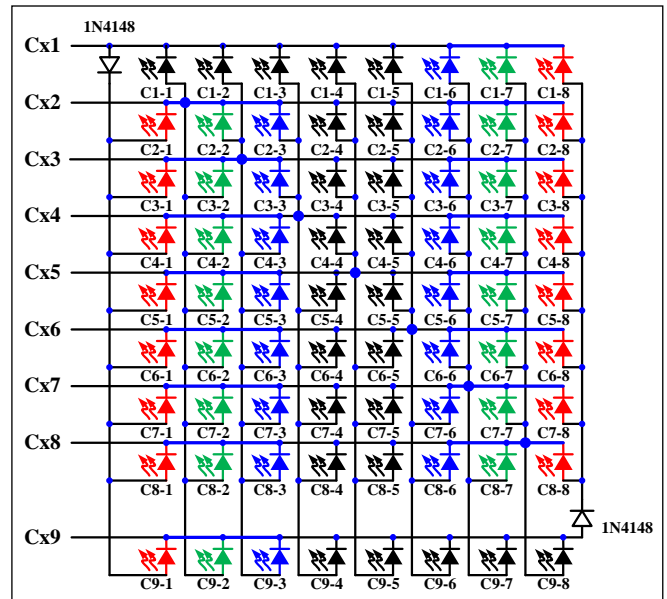

Figure 16 Common Cathode RGBs Connection

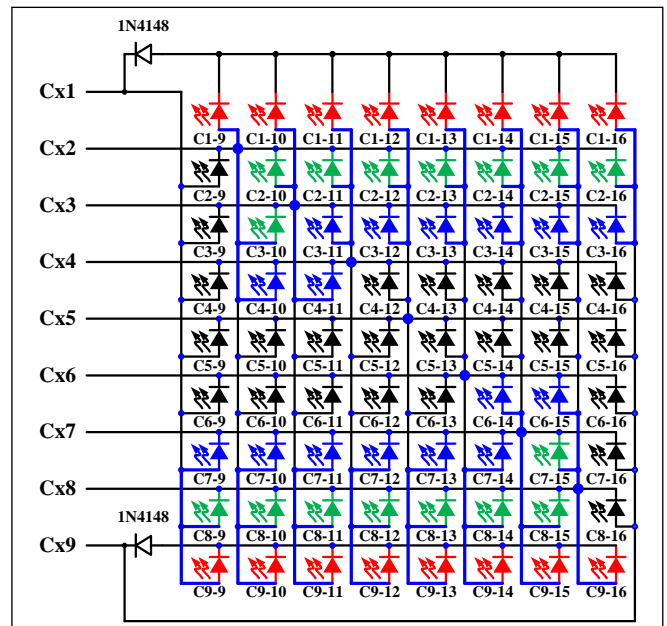

Figure 17 Common Anode RGBs Connection

## MORE FRAMES DISPLAY

The IS31FL3732A can store 8 frames data at best. Each 4 frames writing in Frame Registers is recommended if there are more frames to play (Figure 18). First, store 8 frames data and play 4 frames in front. Then play last 4 frames and writing new data in the Frame Registers (1~4) at the same time. Play the new 4 frames (1~4) and write new data in the Frame Registers (5~8).

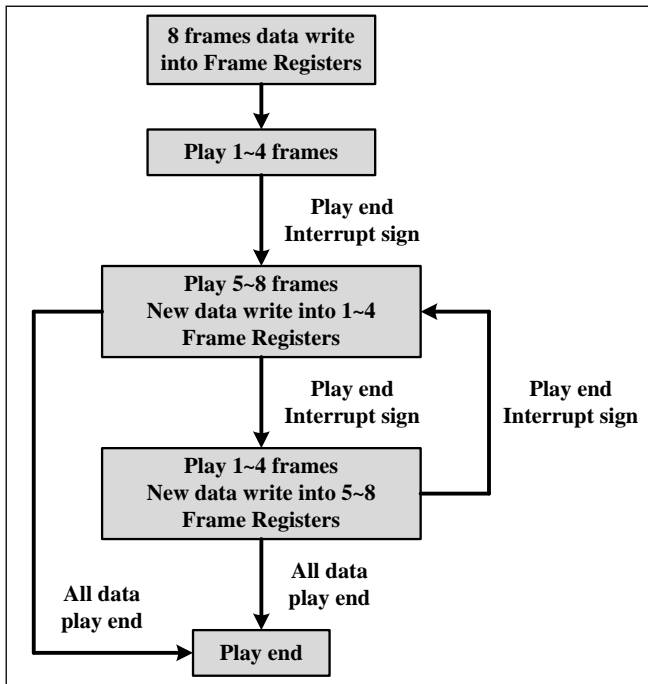

Figure 18 More Frame Data Writing In

## SHUTDOWN MODE

Shutdown mode can be used as a means of reducing power consumption. During shutdown mode all registers retain their data.

### Software Shutdown

By setting SSD bit of the Shutdown Register (0Ah) to "00", the IS31FL3732A will operate in Software Shutdown 1. When the IS31FL3732A is in Software Shutdown 1, all current sources are switched off, so that the matrix is blanked. All registers (include Function Register and Frame Register) can be written or read when the SDB pin is pulled high. Typical current consume is 370µA.

By setting SSD bit to "10" or "11", the IS31FL3732A will operate in Software Shutdown 2. When the IS31FL3732A is in Software Shutdown 2, all current sources are turned off, the matrix is blanked. Function Register can be written or read. Frame Register can not be written or read. Typical current consume is 3µA.

## Registers Reset

When SDB pin is pulled low, all registers won't be reset. During SDB pin pulled high, Function Registers are reset to "0000 0000" once  $V_{CC}$  drop below 1.75V (Typ.). SDB pin hold in low voltage state (Hardware Shutdown), all analog circuits are shutdown. The Function Register still can be reset in case of Hardware Shutdown when  $V_{CC}$  drops below 0.1V.

Frame Register constructed by SRAM. Frame Registers are random state after power up, and only can be changed by I2C writing operation.

## Hardware Shutdown

The chip enters Hardware Shutdown when the SDB pin is pulled low. All analog circuits are disabled during Hardware Shutdown, typical current consume is 0.1µA.

The chip enters Hardware Enable when the SDB pin is pulled high. During Hardware Shutdown state Function Register can be written and read, but Frame Register cannot be written and read.

If  $V_{CC}$  has risk drop below 1.75V but above 0.1V during SDB pulled low, please re-initialize all Function Registers before SDB pulled high.

## POWER DISSIPATION

The power dissipation of the IS31FL3732A can calculate as below:

$$\begin{aligned}
 P_{3732A} &= I_{PV_{CC}} \times PV_{CC} + I_{CC} \times V_{CC} (AV_{CC}) - I_{PV_{CC}} \times V_{F(AVR)} \quad (4) \\
 &\approx I_{PV_{CC}} \times PV_{CC} - I_{PV_{CC}} \times V_{F(AVR)} \\
 &= I_{PV_{CC}} \times (PV_{CC} - V_{F(AVR)})
 \end{aligned}$$

Where  $I_{PV_{CC}}$  is the current of  $PV_{CC}$  and  $V_{F(AVR)}$  is the average forward of all the LED.

For example, if  $R_{EXT}=20k\Omega$ ,  $GCC=255$ ,  $PWM=255$ ,  $PV_{CC}=5V$ ,  $V_{F(AVR)}=3.4V@34mA$ , then the  $I_{PV_{CC}}=(34mA \times 8 \times 9 / 10.5) \times 2 = 466.29mA$ .

$$P_{3732A} = 466.29mA \times (5V - 3.4V) = 0.746W$$

When operating the chip at high ambient temperatures, or when driving maximum load current, care must be taken to avoid exceeding the package power dissipation limits. The maximum power dissipation can be calculated using the following Formula (5):

$$P_{D(MAX)} = \frac{125^{\circ}C - 25^{\circ}C}{R_{\theta JA}} \quad (5)$$

So,

$$P_{D(MAX)} = \frac{125^{\circ}C - 25^{\circ}C}{24.96^{\circ}C/W} \approx 4W$$

# IS31FL3732A

Figure 19, shows the power derating of the IS31FL3732A on a JEDEC boards (in accordance with JESD 51-5 and JESD 51-7) standing in still air.

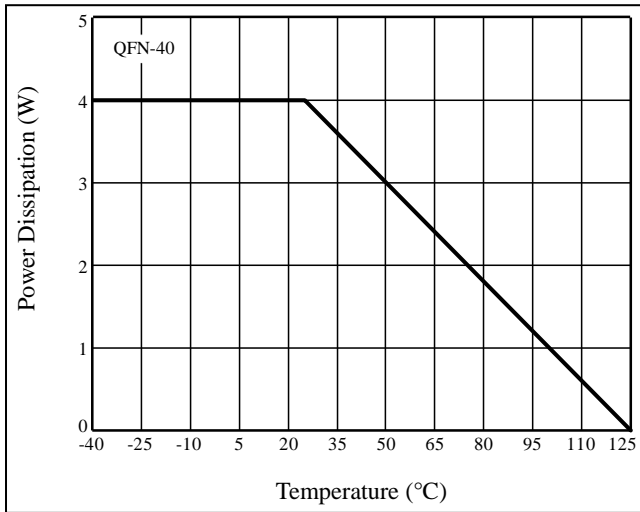

**Figure 19** Dissipation Curve

# IS31FL3732A

## APPLICATION DESIGN

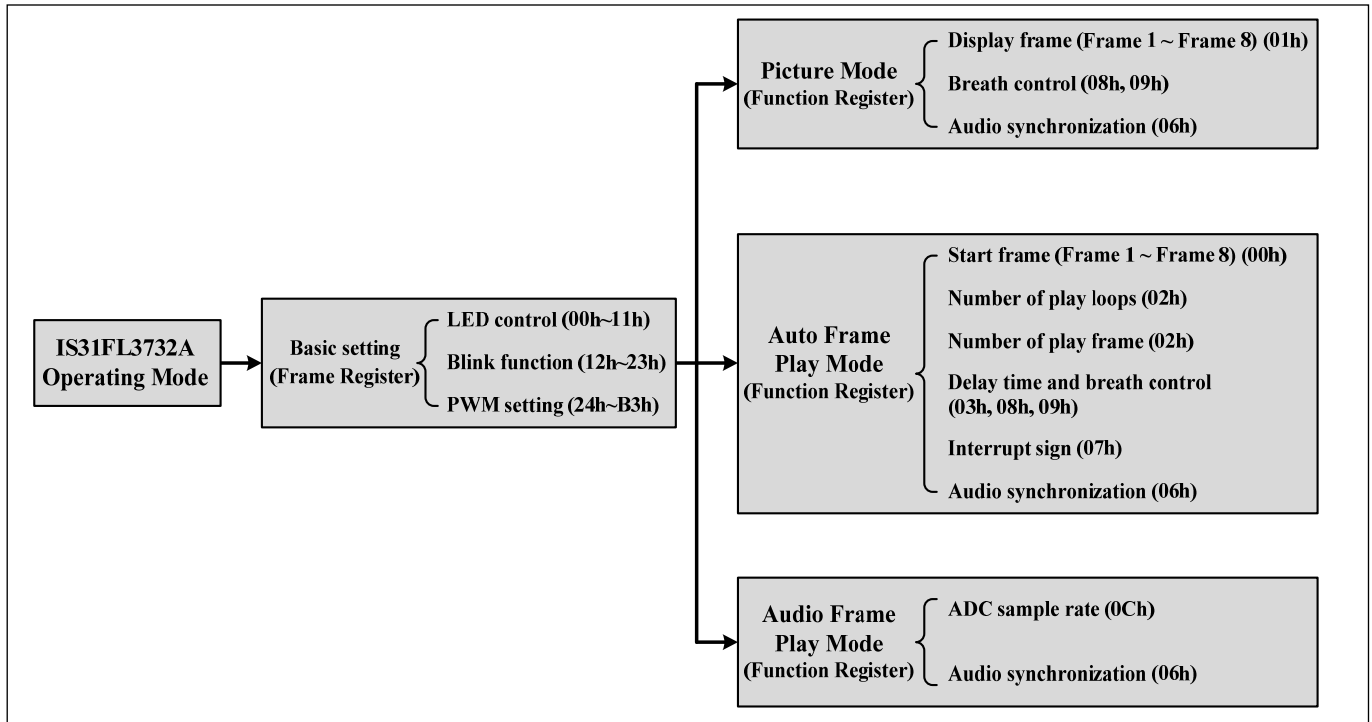

# IS31FL3732A

## CLASSIFICATION REFLOW PROFILES

Profile Feature	Pb-Free Assembly
<b>Preheat &amp; Soak</b>	
Temperature min (T <sub>smin</sub> )	150°C
Temperature max (T <sub>smax</sub> )	200°C
Time (T <sub>smin</sub> to T <sub>smax</sub> ) (t <sub>s</sub> )	60-120 seconds
Average ramp-up rate (T <sub>smax</sub> to T <sub>p</sub> )	3°C/second max.
Liquidous temperature (T <sub>L</sub> )	217°C
Time at liquidous (t <sub>L</sub> )	60-150 seconds
Peak package body temperature (T <sub>p</sub> )*	Max 260°C
Time (t <sub>p</sub> )** within 5°C of the specified classification temperature (T <sub>c</sub> )	Max 30 seconds
Average ramp-down rate (T <sub>p</sub> to T <sub>smax</sub> )	6°C/second max.
Time 25°C to peak temperature	8 minutes max.

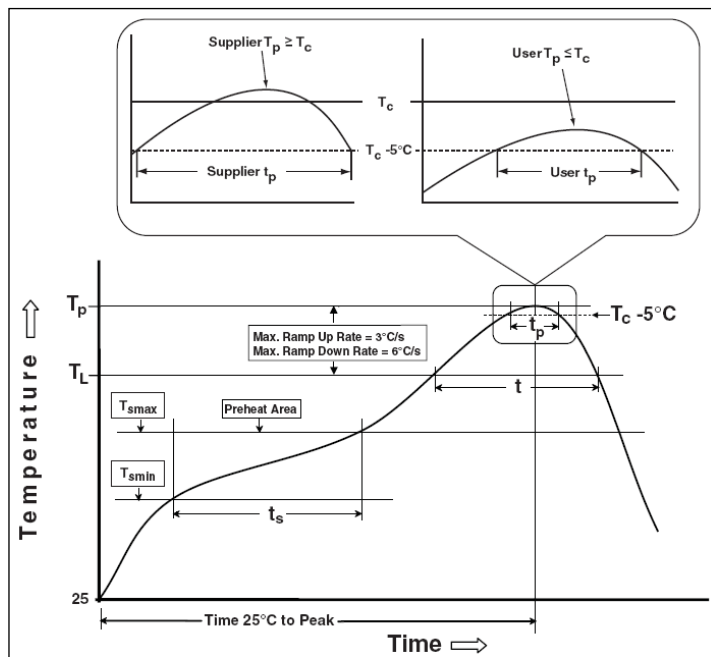

Figure 20 Classification Profile



# IS31FL3732A

## PACKAGE INFORMATION

### QFN-40

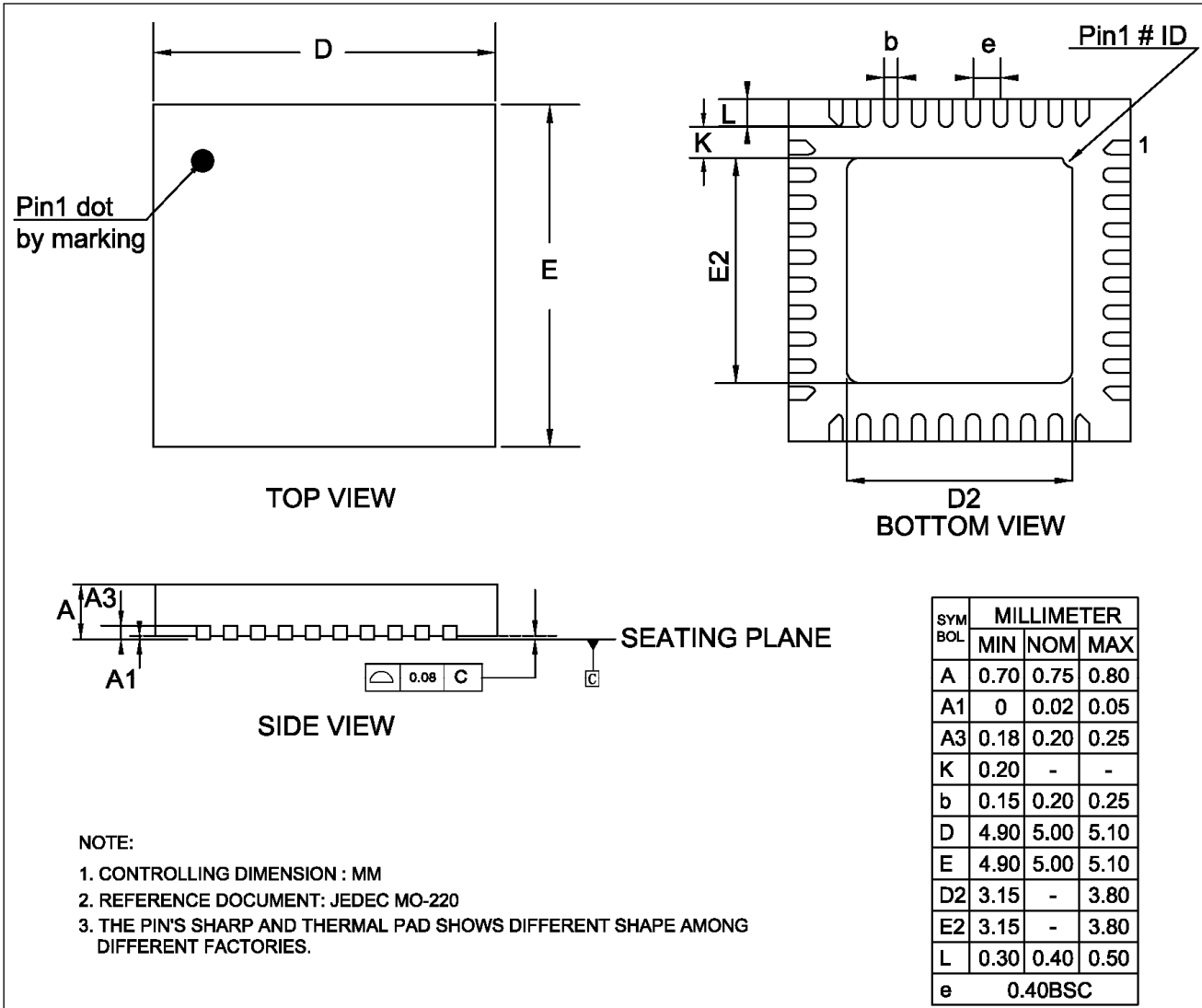

# IS31FL3732A

## RECOMMENDED LAND PATTERN

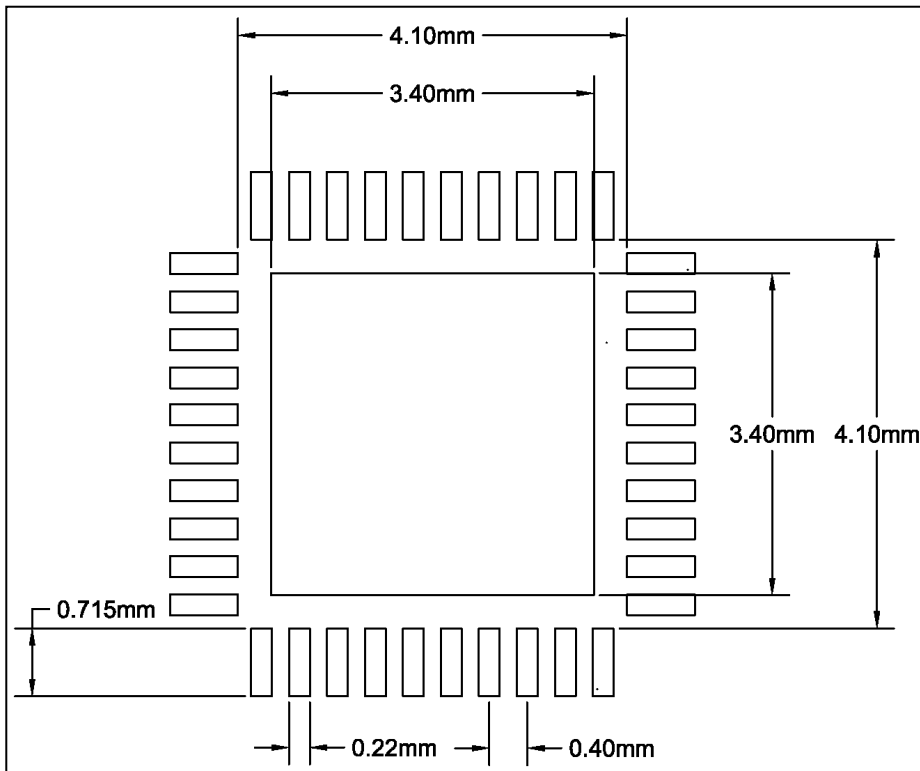

### Note:

1. Land pattern complies to IPC-7351.
2. All dimensions in MM.
3. This document (including dimensions, notes & specs) is a recommendation based on typical circuit board manufacturing parameters. Since land pattern design depends on many factors unknown (eg. user's board manufacturing specs), user must determine suitability for use.



# IS31FL3732A

## REVISION HISTORY

Revision	Detail Information	Date
A	Initial release	2016.11.03
B	1. Correct part number 2. Update READING OPERATION section 3. Update Figure 16,17 with diodes	2016.12.05
C	1. Update POD 2. Update land pattern	2017.07.04