

# Keysight N6700 Modular Power System Family

N6731B-N6792A DC Power & Load Modules  
N6700C-N6705C Mainframes



Specifications Guide

## Legal Notices

© Keysight Technologies 2010 - 2019

No part of this document may be photocopied, reproduced, or translated to another language without the prior agreement and written consent of Keysight Technologies as governed by United States and international copyright laws.

### Manual Part Number

N6700-90001

### Edition

Edition 10, February 2019

### Printed in

Available in electronic format only

### Published by

Keysight Technologies, Inc.  
550 Clark Drive, Suite 101  
Budd Lake, NJ 07828 USA

### Technologies Licenses

The hardware and or software described in this document are furnished under a license and may be used or copied only in accordance with the terms of such license.

### Warranty

THE MATERIAL CONTAINED IN THIS DOCUMENT IS PROVIDED "AS IS," AND IS SUBJECT TO BEING CHANGED, WITHOUT NOTICE, IN FUTURE EDITIONS. FURTHER, TO THE MAXIMUM EXTENT PERMITTED BY APPLICABLE LAW, KEYSIGHT DISCLAIMS ALL WARRANTIES, EITHER EXPRESS OR IMPLIED, WITH REGARD TO THIS MANUAL AND ANY INFORMATION CONTAINED HEREIN, INCLUDING BUT NOT LIMITED TO THE IMPLIED WARRANTIES OF MERCHANTABILITY AND FITNESS FOR A PARTICULAR PURPOSE. KEYSIGHT SHALL NOT BE LIABLE FOR ERRORS OR FOR INCIDENTAL OR CONSEQUENTIAL DAMAGES IN CONNECTION WITH THE FURNISHING, USE, OR PERFORMANCE OF THIS DOCUMENT OR OF ANY INFORMATION CONTAINED HEREIN. SHOULD KEYSIGHT AND THE USER HAVE A SEPARATE WRITTEN AGREEMENT WITH WARRANTY TERMS COVERING THE MATERIAL IN THIS DOCUMENT THAT CONFLICT WITH THESE TERMS, THE WARRANTY TERMS IN THE SEPARATE AGREEMENT SHALL CONTROL.

## U.S. Government Rights

The Software is "commercial computer software," as defined by Federal Acquisition Regulation ("FAR") 2.101. Pursuant to FAR 12.212 and 27.405-3 and Department of Defense FAR Supplement ("DFARS") 227.7202, the U.S. government acquires commercial computer software under the same terms by which the software is customarily provided to the public. Accordingly, Keysight provides the Software to U.S. government customers under its standard commercial license, which is embodied in its End User License Agreement (EULA), a copy of which can be found at [www.keysight.com/find/sweula](http://www.keysight.com/find/sweula). The license set forth in the EULA represents the exclusive authority by which the U.S. government may use, modify, distribute, or disclose the Software. The EULA and the license set forth therein, does not require or permit, among other things, that Keysight: (1) Furnish technical information related to commercial computer software or commercial computer software documentation that is not customarily provided to the public; or (2) Relinquish to, or otherwise provide, the government rights in excess of these rights customarily provided to the public to use, modify, reproduce, release, perform, display, or disclose commercial computer software or commercial computer software documentation. No additional government requirements beyond those set forth in the EULA shall apply, except to the extent that those terms, rights, or licenses are explicitly required from all providers of commercial computer software pursuant to the FAR and the DFARS and are set forth specifically in writing elsewhere in the EULA. Keysight shall be under no obligation to update, revise or otherwise modify the Software. With respect to any technical data as defined by FAR 2.101, pursuant to FAR 12.211 and 27.404.2 and DFARS 227.7102, the U.S. government acquires no greater than Limited Rights as defined in FAR 27.401 or DFAR 227.7103-5 (c), as applicable in any technical data.

## Declaration of Conformity

Declarations of Conformity for this product and for other Keysight products may be downloaded from the Web. Go to <http://www.keysight.com/go/conformity>.

## Regulatory Symbols



The CE mark shows that the product complies with all applicable European Directives.



The RCM mark is a registered trademark of the Australian Communications and Media Authority.

ICES/NMB-001

This ISM device complies with Canadian ICES-001.

Cet appareil ISM est conforme à la norme NMB-001 du Canada.

ISM GROUP 1 CLASS A

This is the symbol for an Industrial, Scientific and Medical, Group 1 Class A product.



The CSA mark is a registered trademark of Intertek-etlsemko Inc.



This is the RoHS (Restriction of Hazardous Substances) symbol for electrical and electronic equipment.



South Korean Class A EMC Declaration

This equipment has been conformity assessed for use in business environments. In a residential environment this equipment may cause radio interference. This EMC statement applies to the equipment only for use in business environments.



This symbol indicates separate collection for electrical and electronic equipment mandated under EU law as of August 13, 2005. All electric and electronic equipment are required to be separated from normal waste for disposal (Reference WEEE Directive 2002/96/EC).

## Where to Find More Information

This document provides specification and supplemental characteristic information for the following instruments:

- Keysight N6731B through N6792A Power and Load Modules
- Keysight N6700C-series and N6705C Mainframes

For additional technical details and ordering information for the Keysight N6700 Modular Power System Family, refer to the following:

Document	Description
<i>Keysight N6700 Modular Power System Family: Low-Profile MPS Mainframe for Automated Test Environments</i>	The Keysight N6700 Low-Profile Modular Power System (MPS) is a 1U (rack unit) high, multiple-output programmable DC power supply system that enables test system integrators to optimize performance, power and price to match test needs. Go to: <a href="http://literature.cdn.keysight.com/litweb/pdf/5992-1857EN.pdf">http:// literature.cdn.keysight.com/litweb/pdf/5992-1857EN.pdf</a>
<i>Keysight N6705 Modular Power System Family: DC Power Analyzer Mainframe for R&amp;D</i>	The Keysight N6705 DC Power Analyzer represents an entirely new instrument category for R&D engineers. It provides unrivaled productivity gains when sourcing and measuring DC voltage and current into a DUT. Using the Keysight N6705 DC Power Analyzer, R&D engineers can gain insights into the DUT's power consumption in minutes, with all sourcing and measuring functions available from the front panel. Go to: <a href="http:// literature.cdn.keysight.com/litweb/pdf/5992-1880EN.pdf">http:// literature.cdn.keysight.com/litweb/pdf/5992-1880EN.pdf</a>
<i>Keysight N6700 Modular Power System Family: N6780 Series Source/Measure Units</i>	The Keysight N6781A/82A/85A/86A 2-quadrant SMUs offer advanced sourcing and measurement capabilities required to overcome test challenges associated with optimizing power consumption and maximizing battery life of battery-powered devices and their components. The Keysight N6784A 4-quadrant SMU offers advanced sourcing and measurement capabilities in four quadrants for general purpose applications. Go to: <a href="http:// literature.cdn.keysight.com/litweb/pdf/5990-5829EN.pdf">http:// literature.cdn.keysight.com/litweb/pdf/5990-5829EN.pdf</a>
<i>Keysight N6700 Modular Power System Family: Battery Charge/Discharge Module</i>	The Keysight N6783A-BAT battery charge/discharge module is a basic, 2-quadrant DC power module designed to be used by mobile device designers. Its 2-quadrant operation allows it to act as a programmable power supply to charge the battery or as a programmable electronic load to discharge the battery, all in one instrument. Go to: <a href="http:// literature.cdn.keysight.com/litweb/pdf/5990-8662EN.pdf">http:// literature.cdn.keysight.com/litweb/pdf/5990-8662EN.pdf</a>
<i>Keysight N6700 Modular Power System Family: Mobile Communications DC Power Module</i>	The Keysight N6783A-MFG mobile communications DC power module offers advanced features specifically for testing battery-powered (mobile) devices in manufacturing or automated test environments. Go to: <a href="http:// literature.cdn.keysight.com/litweb/pdf/5990-8643EN.pdf">http:// literature.cdn.keysight.com/litweb/pdf/5990-8643EN.pdf</a>

### NOTE

You can contact Keysight Technologies at one of the following telephone numbers for warranty, service, or technical support information.

In the United States: (800) 829-4444

In Europe: 31 20 547 2111

In Japan: 0120-421-345

Or use our Web link for information on contacting Keysight in your country or specific location: [www.keysight.com/find/assist](http://www.keysight.com/find/assist)

Or contact your Keysight Technologies Representative.

The web contains the most up to date version of this manual.

Go to <http:// literature.cdn.keysight.com/litweb/pdf/N6700-90001.pdf>.

# Contents

<b>1.- Power Module Differences .....</b>	<b>7</b>
Power Module Differences: Keysight N6700C Modular Power Systems .....	8
Power Module Differences: Keysight N6705C DC Power Analyzers	11
Power Module Option Characteristics .....	14
<b>2 - Keysight N673xB, N674xB, N677xA DC Power Modules.....</b>	<b>15</b>
Performance Specifications (N6731B-N6746B).....	16
Performance Specifications (N6773A-N6777A).....	17
Supplemental Characteristics (N6731B-N6746B) .....	18
Supplemental Characteristics (N6773A-N6777A).....	19
Output Quadrant Characteristic .....	21
Arbitrary Waveform Generator Maximum Bandwidth.....	21
<b>3 - Keysight N675xA High Performance Power Modules.....</b>	<b>23</b>
Performance Specifications.....	24
Supplemental Characteristics .....	25
Autoranging Characteristic.....	27
Output Impedance Graphs .....	27
Arbitrary Waveform Generator Maximum Bandwidth.....	30
<b>4 - Keysight N676xA Precision Power Modules .....</b>	<b>31</b>
Performance Specifications.....	32
Supplemental Characteristics .....	33
Autoranging Characteristic.....	35
Output Impedance Graphs .....	35
Arbitrary Waveform Generator Maximum Bandwidth.....	37
<b>5 - Keysight N678xA Source/Measure Units .....</b>	<b>39</b>
Performance Specifications.....	40
Supplemental Characteristics .....	42
Output Quadrant Characteristic .....	47
Output Impedance Graphs .....	48
Voltage Programming Response.....	50
Measurement Accuracy and Resolution .....	52
<b>6 - Keysight N6783A-BAT, N6783A-MFG Application-Specific Power Modules.....</b>	<b>53</b>
Performance Specifications.....	54
Supplemental Characteristics .....	55
Output Quadrant Characteristic .....	56

<b>7 - Keysight N6791A, N6792A Electronic Load Modules.....</b>	<b>57</b>
Performance Specifications.....	58
Supplemental Characteristics .....	58
Output Quadrant Characteristic .....	60
<b>8 - Keysight N6700 and N6705 series Mainframes.....</b>	<b>61</b>
Supplemental Characteristics .....	62
Outline Diagrams .....	64



# Chapter 1

## Power Module Differences

Power Module Differences: Keysight N6700C Modular Power Systems .....	8
Power Module Differences: Keysight N6705C DC Power Analyzers	11
Power Module Option Characteristics .....	14

This chapter provides a brief overview of the basic differences between the Keysight N6700 series DC Power Modules. Note that the basic capabilities of a power module depend not only on its hardware capabilities, but also the on the hardware and firmware capabilities of the mainframe in which it is installed.

In addition to their primary output and measurement capabilities, power modules installed in a Keysight N6705C DC Power Analyzer have expanded capabilities such as front panel scope view, arbitrary waveform generation, and internal and external data logging.

Refer to the Keysight N6700C or N6705C User's Guide for more information about the power module capabilities.

# Power Module Differences: Keysight N6700C Modular Power Systems

## Keysight N6731B–N6777A Differences

Feature (● = available)	DC Power N673xB, N674xB, N677xA	High-Performance N675xA	Precision N676xA
50 W output rating	N6731B – N6736B	N6751A	N6761A
100 W output rating	N6741B – N6746B	N6752A	N6762A
300 W output rating	N6773A – N6777A	N6753A, N6754A	N6763A, N6764A
500 W output rating		N6755A, N6756A	N6765A, N6766A
Output disconnect relays	Option 761	Option 761	Option 761
Output disconnect/polarity reversal relays <sup>NOTE 1</sup>	Option 760	Option 760	Option 760
Autoranging output capability		●	●
Voltage or current turn-on preferred mode			N6761A, N6762A
Precision voltage and current measurements			●
Low voltage and low current output range			N6761A, N6762A
Low voltage and low current measurement range			●
200 microampere measurement range <sup>NOTE 2</sup>			Option 2UA
Simultaneous voltage and current measurements			●
SCPI command output list capability <sup>NOTE 3</sup>	Option 054	Option 054	●
SCPI command array readback <sup>NOTE 3</sup>	Option 054	Option 054	●
SCPI command programmable sample rate <sup>NOTE 3</sup>	Option 054	Option 054	●
SCPI command external data logging <sup>NOTE 3</sup>	Option 054	Option 054	●
Double-wide (occupies 2 channel locations)		N6753A – N6756A	N6763A – N6766A

<sup>1</sup> Option 760 limits the output current to 10A maximum on Models N6742B and N6773A.  
Option 760 is not available on Models N6741B, N6751A, N6752A, N6761A, and N6762A.

<sup>2</sup> Option 2UA is only available on Models N6761A and N6762A. It includes Option 761.

<sup>3</sup> Only available when using the remote interfaces; not from the front panel.



## Keysight N6781A–N6786A Differences

Feature (● = available)	Source/Measure Units (SMU)					Application-Specific	
	N6781A	N6782A	N6784A	N6785A	N6786A	N6783A BAT	N6783A MFG
Output rating	20 W	20 W	20 W	80 W	80 W	24 W	18 W
2-quadrant operation	●	●		●	●	●	●
4-quadrant operation			●				
Auxiliary voltage measurement input	●			●			
Output disconnect relays	●	●	●	●	●	Option 761	Option 761
Negative voltage protection	●	●	●	●	●	●	●
Voltage or current priority mode	●	●	●	●	●		
Programmable output resistance	●			●			
Multiple voltage output ranges	3	3	3	4	4		
Multiple current output ranges	3	3	4	4	4		
Multiple voltage measurement ranges	3	3	3				
Multiple current measurement ranges	4	4	4	3	3	2	2
Simultaneous voltage and current measurements	●	●	●	●	●		
Seamless measurement autoranging	●	●	Opt SMR	●	●		
SCPI command output list capability <sup>NOTE 1, 2</sup>	●	●	●	●	●	●	●
SCPI command array readback <sup>NOTE 2</sup>	●	●	●	●	●	●	●
SCPI command programmable sample rate <sup>NOTE 2</sup>	●	●	●	●	●	●	●
SCPI command external data logging <sup>NOTE 2</sup>	●	●	●	●	●	●	●
Double-wide (occupies 2 channel locations)				●	●		

<sup>1</sup> List capability is not available on the negative current output on Model N6783A.

<sup>2</sup> Only available when using the remote interfaces; not the front panel.

## Keysight N679xA Load Module Differences

Feature (● = available)	Load Module	
	N6791A	N6792A
Input rating <sup>NOTE 1</sup>	100 W	200 W
Input terminal short capability	●	●
Arbitrary waveform generation	●	●
Under voltage inhibit	●	●
Voltage, current, power, and resistance priority	●	●
Number of resistance input ranges	3	3
Number of current input and measurement ranges	2	2
Number of voltage input and measurement ranges	1	1
Number of power measurement ranges	2	2
Simultaneous voltage and current measurements	●	●
SCPI command output list capability <sup>NOTE 2</sup>	●	●
SCPI command array readback <sup>NOTE 2</sup>	●	●
SCPI command programmable sample rate <sup>NOTE 2</sup>	●	●
SCPI command external data logging <sup>NOTE 2</sup>	●	●
Double-wide (occupies 2 channel locations)		●

<sup>1</sup> The load module's input is referred to by the term "Output" throughout this document.

<sup>2</sup> Only available when using the remote interfaces; not from the front panel..

# Power Module Differences: Keysight N6705C DC Power Analyzers

## Keysight N6731B–N6777A Differences

Feature (● = available)	DC Power N673xB, N674xB, N677xA	High-Performance N675xA	Precision N676xA
50 W output rating	N6731B – N6736B	N6751A	N6761A
100 W output rating	N6741B – N6746B	N6752A	N6762A
300 W output rating	N6773A – N6777A	N6753A, N6754A	N6763A, N6764A
500 W output rating		N6755A, N6756A	N6765A, N6766A
Output disconnect relays	Option 761	Option 761	Option 761
Output disconnect/polarity reversal relays <sup>NOTE 1</sup>	Option 760	Option 760	Option 760
Arbitrary waveform generation	●	●	●
Autoranging output capability		●	●
Voltage or current turn-on preferred mode			N6761A, N6762A
Precision voltage and current measurements			●
Low voltage and low current output range			N6761A, N6762A
Low voltage and low current measurement range			●
200 microampere measurement range <sup>NOTE 2</sup>			Option 2UA
Voltage or current scope traces	●	●	●
Simultaneous voltage and current scope traces			●
Simultaneous voltage and current data logging <sup>NOTE 3</sup>			●
Interleaved voltage and current data logging <sup>NOTE 3</sup>	●	●	
Dynamic current correction	●	N6751A, N6752A	N6761A, N6762A
SCPI command output list capability <sup>NOTE 4</sup>	●	●	●
SCPI command array readback <sup>NOTE 4</sup>	●	●	●
SCPI command programmable sample rate <sup>NOTE 4</sup>	●	●	●
SCPI command external data logging <sup>NOTE 4</sup>	●	●	●
Double-wide (occupies 2 channel locations)		N6753A – N6756A	N6763A – N6766A

<sup>1</sup> Option 760 limits the output current to 10A maximum on Models N6742B and N6773A.

Option 760 is not available on Models N6741B, N6751A, N6752A, N6761A, and N6762A.

<sup>2</sup> Option 2UA is only available on Models N6761A and N6762A. It includes Option 761.

<sup>3</sup> Option 055 deletes the Data Logger function on Model N6705.

<sup>4</sup> Only available when using the remote interfaces; not from the front panel.

## Keysight N6781A–N6786A Differences

Feature (● = available)	Source/Measure Units (SMU)					Application-Specific	
	N6781A	N6782A	N6784A	N6785A	N6786A	N6783A BAT	N6783A MFG
Output rating	20 W	20 W	20 W	80 W	80 W	24 W	18 W
2-quadrant operation	●	●		●	●	●	●
4-quadrant operation			●				
Auxiliary voltage measurement input	●			●			
Output disconnect relays	●	●	●	●	●	Option 761	Option 761
Arbitrary waveform generation <sup>NOTE 1</sup>	●	●	●	●	●	●	●
Negative voltage protection	●	●	●	●	●	●	●
Voltage or current priority mode	●	●	●	●	●		
CC load/CV load	●	●	●	●	●		
Voltage/current measurement only	●	●	●	●	●		
Battery emulator/charger	●			●			
Programmable output resistance	●			●			
Multiple voltage output ranges	3	3	3	4	4		
Multiple current output ranges	3	3	4	4	4		
Multiple voltage measurement ranges	3	3	3				
Multiple current measurement ranges	4	4	4	3	3	2	2
Voltage or current scope traces	●	●	●	●	●	●	●
Simultaneous voltage and current measurements	●	●	●	●	●		
Simultaneous voltage and current data logging <sup>NOTE 2</sup>	●	●	●	●	●		
Interleaved voltage and current data logging <sup>NOTE 2</sup>						●	●
Seamless measurement autoranging	●	●	Opt SMR	●	●		
SCPI command output list capability <sup>NOTE 1, 3</sup>	●	●	●	●	●	●	●
SCPI command array readback <sup>NOTE 3</sup>	●	●	●	●	●	●	●
SCPI command programmable sample rate <sup>NOTE 3</sup>	●	●	●	●	●	●	●
SCPI command external data logging <sup>NOTE 3</sup>	●	●	●	●	●	●	●
SCPI command histogram measurements <sup>NOTE 3</sup>	●	●		●	●		
Double-wide (occupies 2 channel locations)				●	●		

<sup>1</sup> Arbitrary waveform generation and list capability are not available on the negative current output on Model N6783A.

<sup>2</sup> Option 055 deletes the Data Logger function on Model N6705.

<sup>3</sup> Only available when using the remote interfaces; not the front panel.

## Keysight N679xA Load Module Differences

Feature (● = available)	Load Module	
	N6791A	N6791A
Input rating <sup>NOTE 1</sup>	100 W	200 W
Input terminal short capability	●	●
Arbitrary waveform generation	●	●
Under voltage inhibit	●	●
Voltage, current, power, and resistance priority	●	●
Number of resistance ranges	3	3
Number of current input and measurement ranges	2	2
Number of voltage input and measurement ranges	1	1
Number of power input and measurement ranges	2	2
Simultaneous voltage and current measurements	●	●
SCPI command output list capability <sup>NOTE 2</sup>	●	●
SCPI command array readback <sup>NOTE 2</sup>	●	●
SCPI command programmable sample rate <sup>NOTE 2</sup>	●	●
SCPI command external data logging <sup>NOTE 2</sup>	●	●
Double-wide (occupies 2 channel locations)		●

<sup>1</sup> The load module's input is referred to by the term "Output" throughout this document.

<sup>2</sup> Only available when using the remote interfaces; not from the front panel.

# Power Module Option Characteristics

## Option 760 & 761

Option 761 provides output and sense disconnect relays. Option 760 provides polarity reversal in addition to output and sense disconnect. Note that models N678xA SMU have output and sense disconnect relays built in.

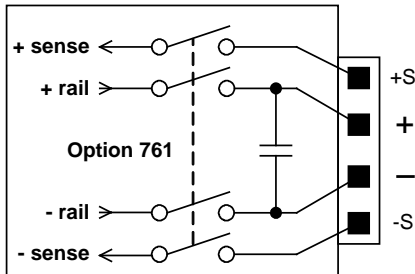

- Option 760 limits the output current to 10 A on Models N6742B and N6773A.

- Option 760 is not available on Models N6741B, N6751A, N6752A, N6761A, N6762A, and N6781A – N6786A

Although the plus and minus rail of the output power mesh are physically disconnected from the output terminals with options 760 and 761, a small AC network is still connected across the plus and minus output terminals (see figure).

## Option 054

Option 054 (High-speed Test Extensions) include output list and digitized measurement capability. This option is separately orderable for Models N673xB, N674xB, N677xA, and N675xA when installed in an N6700 MPS mainframes. All other power modules as well as the N6705 DC Power Analyzer mainframes have output list and digitized measurement capability built in.

Output list:

- Maximum number of steps = 512
- Maximum dwell time in seconds = 262
- Maximum list repetitions = 256 or infinite

Digitized measurement:

- Maximum measurement points = 524,288
- Maximum sample rate = 97.656 kHz

## Option 2UA

Option 2UA is a 200 microampere measurement range available on Models N6761A and N6762A only. It includes Option 761 relay capability.

## Option SMR

Option SMR is seamless measurement autoranging for Model N6784A. It is included with Models N6781A, N6782A, N6785A, and N6786A.

# Chapter 2

## Keysight N673xB, N674xB, N677xA DC Power Modules

Performance Specifications (N6731B-N6746B).....	16
Performance Specifications (N6773A-N6777A).....	17
Supplemental Characteristics (N6731B-N6746B) .....	18
Supplemental Characteristics (N6773A-N6777A).....	19
Output Quadrant Characteristic .....	21
Arbitrary Waveform Generator Maximum Bandwidth.....	21

Unless otherwise noted, specifications are warranted over the ambient temperature range of 0 to 40°C after a 30-minute warm-up period. Unless otherwise noted, accuracy is specified as percent of value + fixed offset.

Specifications apply at the output terminals, with each module's sense terminals internally connected to its output terminals (local sensing).

Refer to the Keysight N6700 or N6705 Service Guide for the setup conditions for all performance specifications.

Supplemental characteristics are not warranted but are descriptions of performance determined either by design or by type testing. All supplemental characteristics are typical unless otherwise noted.

## Performance Specifications (N6731B-N6746B)

	N6731B/ N6741B	N6732B/ N6742B	N6733B/ N6743B	N6734B/ N6744B	N6735B/ N6745B	N6736B/ N6746B
<b>DC Output Ratings:</b>						
Voltage	0 - 5 V	0 - 8 V	0 - 20 V	0 - 35 V	0 - 60 V	0 - 100 V
Current	0-10 A / 0-20 A	0-6.25 A / 0-12.5 A	0-2.5 A / 0-5 A	0-1.5 A / 0-3 A	0-0.8 A / 0-1.6 A	0-0.5 A / 0-1 A
Power	50 W / 100 W	50 W / 100 W	50 W / 100 W	52.5W / 105W	50 W / 100 W	50 W / 100 W
<b>Output Ripple and Noise (PARD):</b> (from 20 Hz - 20 MHz)						
CV peak-to- peak	10 mV / 20 mV	12 mV	14 mV	15 mV	25 mV	30 mV
CV rms	2 mV	2 mV	3 mV	5 mV	9 mV	18 mV
<b>Load Effect (Regulation):</b> (Applies for any output load change, with a maximum load-lead drop of 1V/lead. The load lead drop reduces the maximum available voltage at the load.)						
Voltage	5 mV	6 mV	9 mV	11 mV	13 mV / 16 mV	20 mV / 30 mV
Current	2 mA	2 mA	2 mA	2 mA	2 mA	2 mA
<b>Source Effect (Regulation):</b>						
Voltage	1 mV	2 mV	2 mV	4 mV	6 mV	10 mV
Current	1 mA	1 mA	1 mA	1 mA	1 mA	1 mA
<b>Programming Accuracy:</b> (@ 23 °C ±5 °C after a 30 minute warm-up. Applies from minimum to maximum programming range at any load.)						
Voltage	0.1% + 19 mV	0.1% + 19 mV	0.1% + 20 mV	0.1% + 35 mV	0.1% + 60 mV	0.1% + 100 mV
Current	0.15% + 20 mA	0.15% + 20 mA	0.15% + 20mA	0.15% + 20mA	0.15% + 20mA	0.15% + 10mA
<b>Voltmeter/Ammeter Measurement Accuracy:</b> (@ 23 °C ±5 °C. Applies when measuring the default value of 1024 data points with a 20.48 μs time interval.)						
Voltage	0.1% + 20 mV	0.1% + 20 mV	0.1% + 20 mV	0.1% + 35 mV	0.1% + 60 mV	0.1% + 100 mV
Current	0.15% + 20 mA	0.15% + 10 mA	0.15% + 5 mA	0.15% + 4 mA	0.15% + 4 mA	0.15% + 2 mA
<b>Load Transient Recovery Time:</b> (Time to recover to within the settling band following a load change from 50% to 100% and from 100% to 50% of full load.)						
Settling band	±0.08 V / 0.1 V	±0.08 V / 0.1 V	± 0.2 V / 0.3 V	± 0.2 V / 0.3 V	± 0.4 V / 0.5 V	± 0.5 V / 1.0 V
Time	< 200 μs	< 200 μs	< 200 μs	< 200 μs	< 200 μs	< 200 μs



## Performance Specifications (N6773A-N6777A)

	N6773A	N6774A	N6775A	N6776A	N6777A
<b>DC Output Ratings:</b>					
Voltage	0 - 20 V	0 - 35 V	0 - 60 V	0 - 100 V	0 - 150 V
Current <sup>NOTE 1</sup>	0 - 15 A <sup>NOTE 2</sup>	0 - 8.5 A	0 - 5 A	0 - 3 A	0 - 2 A
Power	300 W	300 W	300 W	300 W	300 W
<b>Output Ripple and Noise (PARD):</b> (from 20 Hz - 20 MHz)					
CV peak-to- peak	20 mV	22 mV	35 mV	45 mV	68 mV
CV rms	3 mV	5 mV	9 mV	18 mV	27 mV
<b>Load Effect (Regulation):</b> (Applies for any output load change, with a maximum load-lead drop of 1V/lead. The load lead drop reduces the maximum available voltage at the load.)					
Voltage	13 mV	16 mV	24 mV	45 mV	68 mV
Current	6 mA	6 mA	6 mA	6 mA	6 mA
<b>Source Effect (Regulation):</b>					
Voltage	2 mV	4 mV	6 mV	10 mV	15 mV
Current	1 mA	1 mA	1 mA	1 mA	1 mA
<b>Programming Accuracy:</b> (@ 23 °C ±5 °C after 30 minute warm-up. Applies from minimum to maximum programming range at any load.)					
Voltage	0.1% + 20 mV	0.1% + 35 mV	0.1% + 60 mV	0.1% + 100 mV	0.1% + 150 mV
Current	0.15% + 60 mA	0.15% + 60 mA	0.15% + 60 mA	0.15% + 30 mA	0.15% + 30 mA
<b>Voltmeter/Ammeter Measurement Accuracy:</b> (@ 23 °C ±5 °C. Applies when measuring the default value of 1024 data points with a 20.48 μs time interval.)					
Voltage	0.1% + 20 mV	0.1% + 35 mV	0.1% + 60 mV	0.1% + 100 mV	0.1% + 150 mV
Current	0.15% + 15 mA	0.15% + 12 mA	0.15% + 12 mA	0.15% + 6 mA	0.15% + 6 mA
<b>Load Transient Recovery Time:</b> (Time to recover to within the settling band following a load change from 50% to 100% and from 100% to 50% of full load.)					
Settling band	± 0.3 V <sup>NOTE 4</sup>	± 0.3 V <sup>NOTE 4</sup>	± 0.5 V	± 1.0 V	± 2.0 V
Time	< 250 μs	< 250 μs	< 250 μs	< 250 μs	< 250 μs

<sup>1</sup> Output current is derated 1% per °C above 40°C.

<sup>2</sup> When relay option 760 is installed on Models N6742B and N6773A, the output current is limited to 10 A.

<sup>3</sup> When relay option 760 or 761 is installed, the settling band is ±0.10V/0.125 V.  
Option 760 is not available on Model N6741B.

<sup>4</sup> When relay option 760 or 761 is installed, the settling band is ±0.35 V.

## Supplemental Characteristics (N6731B-N6746B)

	N6731B/ N6741B	N6732B/ N6742B	N6733B/ N6743B	N6734B/ N6744B	N6735B/ N6745B	N6736B/ N6746B
<b>Programming Ranges:</b>						
Voltage	15 mV – 5.1 V	15 mV – 8.16 V	30 mV – 20.4 V	40 mV – 35.7 V	70 mV – 61.2 V	100 mV – 102 V
Current	60 mA – 10.2A/ 60 mA – 20.4 A	40 mA – 6.375 A/ 40 mA – 12.75 A	10 mA – 2.55 A/ 10 mA – 5.1 A	5 mA – 1.53 A/ 5 mA – 3.06 A	2.5 mA – 0.85 A/ 2.5 mA – 1.7 A	1.5 mA – 0.51A/ 1.5 mA – 1.02 A
<b>Programming Resolution:</b>						
Voltage	3.5 mV	4 mV	7 mV	10 mV	18 mV	28 mV
Current	7 mA	4 mA	3 mA	2 mA	1 mA	0.5 mA
<b>Measurement Resolution:</b>						
Voltage	3 mV	4 mV	10 mV	18 mV	30 mV	50 mV
Current	10 mA	7 mA	3 mA	2 mA	1 mA	0.5 mA
<b>Programming Temperature Coefficient per °C:</b>						
Voltage	0.005% + 0.1mV	0.005% + 0.1 mV	0.005% + 0.2 mV	0.005% + 0.5 mV	0.005% + 0.5 mV	0.005% + 1 mV
Current	0.005% + 1 mA	0.005% + 0.5 mA	0.005% + 0.1 mA	0.005% + 0.05mA	0.005% + 0.02mA	0.005% + 0.02mA
<b>Measurement Temperature Coefficient per °C:</b>						
Voltage	0.01% + 0.1mV	0.01% + 0.1 mV	0.01% + 0.2 mV	0.01% + 0.2 mV	0.01% + 0.5 mV	0.01% + 0.5 mV
Current	0.01% + 1 mA	0.01% + 0.5 mA	0.01% + 0.1 mA	0.01% + 0.05 mA	0.01% + 0.02 mA	0.01% + 0.02 mA
<b>Measurement Small Signal Bandwidth: (– 3 db typical)</b>						
Voltage	25 kHz	25 kHz	25 kHz	25 kHz	25 kHz	25 kHz
Correction On <sup>NOTE 1</sup>	10 kHz	10 kHz	10 kHz	10 kHz	10 kHz	10 kHz
Current <sup>NOTE 2</sup>	25 kHz	25 kHz	25 kHz	25 kHz	25 kHz	25 kHz
Correction On <sup>NOTE 1</sup>	2 kHz	2 kHz	2 kHz	2 kHz	2 kHz	2 kHz
<b>N6705 Mainframe Oscilloscope Measurement Accuracy: (@ 23 °C ±5 °C; accuracy of any individual point in the trace)</b>						
Voltage	0.1% + 25 mV	0.1% + 30 mV	0.1% + 45 mV	0.1% + 75 mV	0.1% + 130 mV	0.1% + 190 mV
Current	0.15% + 70mA	0.15% + 40 mA	0.15% + 20 mA	0.15% + 14 mA	0.15% + 12 mA	0.15% + 7 mA
Correction On <sup>NOTE 1</sup>	0.15% + 50 mA	0.15% + 30 mA	0.15% + 15 mA	0.15% + 10 mA	0.15% + 9 mA	0.15% + 5 mA
<b>Up-programming and Down-programming Time with full resistive load:</b> (Time from 10% to 90% of total voltage excursion; for voltage setting from 0V to full scale and full scale to 0V)						
	20 ms	20 ms	20 ms	20 ms	20 ms	20 ms
<b>Up-programming and Down-programming Settling Time with full resistive load:</b> (Time from start of voltage change to 0.1% of full-scale value; for voltage setting from 0V to full scale and full scale to 0V)						
	100 ms	100 ms	100 ms	100 ms	100 ms	100 ms
<b>Over-voltage Protection:</b>						
Accuracy	0.25% + 50mV	0.25% + 50 mV	0.25% + 75 mV	0.25% + 100 mV	0.25% + 200 mV	0.25% + 250 mV
With Option. 760	0.25%+600mV	0.25% + 600 mV	0.25% + 350 mV	0.25% + 250 mV	0.25% + 300 mV	0.25% + 300 mV
With Option. 761	0.25%+600mV	0.25% + 600 mV	0.25% + 350 mV	0.25% + 250 mV	0.25% + 300 mV	0.25% + 300 mV
Maximum setting	7.5 V	10 V	22 V	38.5 V	66 V	110 V
Response time	50 μs from occurrence of over-voltage condition to start of output shutdown					

### Supplemental Characteristics (continued)

	N6731B/ N6741B	N6732B/ N6742B	N6733B/ N6743B	N6734B/ N6744B	N6735B/ N6745B	N6736B/ N6746B
<b>Output Ripple and Noise (PAR):</b>						
CC rms	8 mA	4 mA	2 mA	2 mA	2 mA	2 mA
<b>Common Mode Noise:</b> (from 20 Hz – 20 MHz; from either output to chassis)						
Rms	1 mA	1 mA	1 mA	1 mA	1 mA	1 mA
Peak-to- peak	< 15 mA	< 10 mA	< 10 mA	< 10 mA	< 10 mA	< 10 mA
<b>Remote Sense Capability:</b>	Outputs can maintain specifications with up to a 1-volt drop per load lead. The load lead drop reduces the maximum available voltage at the load.					
<b>Series and Parallel Operation:</b>	Identically rated outputs can be operated directly in parallel or can be connected for straight series operation.					
<b>Minimum Output Turn-On Delay:</b> (Time from when any Output On command is received until the output starts turning on)						
Without relay	32 ms	32 ms	32 ms	32 ms	32 ms	32 ms
With Option 760	58 ms	58 ms	58 ms	58 ms	58 ms	58 ms

<sup>1</sup> Correction On compensates for current flowing into the output capacitor during voltage transients.

<sup>2</sup> Stated values apply when the load resistance is at or close to zero. To determine the frequency for larger resistance values, refer to the User's Guide under "Measurement System Bandwidth".

### Supplemental Characteristics (N6773A-N6777A)

	N6773A	N6774A	N6775A	N6776A	N6777A
<b>Programming Ranges:</b>					
Voltage	30 mV – 20.4 V	40 mV – 35.7 V	70 mV – 61.2 V	100 mV– 102 V	145 mV –153 V
Current	30 mA – 15.3 A	15 mA – 8.67 A	7.5 mA – 5.1 A	4.5 mA– 3.06 A	2.75mA–2.04 A
<b>Programming Resolution:</b>					
Voltage	7 mV	10 mV	18 mV	28 mV	43 mV
Current	9 mA	6 mA	3 mA	1.5 mA	1 mA
<b>Measurement Resolution:</b>					
Voltage	10 mV	18 mV	30 mV	50 mV	77 mV
Current	9 mA	6 mA	3 mA	1.5 mA	1 mA
<b>Programming Temperature Coefficient per °C:</b>					
Voltage	0.01% + 0.2 mV	0.01% + 0.5 mV	0.01% + 0.5 mV	0.01% + 1 mV	0.01% + 1 mV
Current	0.01% + 0.5 mA	0.01% + 0.5 mA	0.01% + 0.1 mA	0.01% + 0.1 mA	0.01% + 0.1 mA
<b>Measurement Temperature Coefficient per °C:</b>					
Voltage	0.01% + 0.2 mV	0.01% + 0.2 mV	0.01% + 0.5 mV	0.01% + 0.5 mV	0.01% + 0.5 mV
Current	0.01% + 0.5 mA	0.01% + 0.5 mA	0.01% + 0.05 mA	0.01% + 0.05 mA	0.01% + 0.05 mA
<b>Measurement Small Signal Bandwidth:</b> (– 3 db typical)					
Voltage	25 kHz	25 kHz	25 kHz	25 kHz	25 kHz
Correction On <sup>NOTE 1</sup>	10 kHz	10 kHz	10 kHz	10 kHz	10 kHz
Current <sup>NOTE 2</sup>	25 kHz	25 kHz	25 kHz	25 kHz	25 kHz
Correction On <sup>NOTE 1</sup>	2 kHz	2 kHz	2 kHz	2 kHz	2 kHz

## Supplemental Characteristics (continued)

	N6773A	N6774A	N6775A	N6776A	N6777A
<b>N6705 Mainframe Oscilloscope Measurement Accuracy:</b> (@ 23 °C ±5 °C; accuracy of any individual point in the trace)					
Voltage	0.1% + 45 mV	0.1% + 75 mV	0.1% + 120 mV	0.1% + 160 mV	0.1% + 175 mV
Current	0.15% + 45 mA	0.15% + 27 mA	0.15% + 22 mA	0.15% + 12 mA	0.15% + 12 mA
Correction On <sup>NOTE 1</sup>	0.15% + 35 mA	0.15% + 22 mA	0.15% + 19 mA	0.15% + 9 mA	0.15% + 9 mA
<b>Up-programming and Down-programming Time with full resistive load:</b> (Time from 10% to 90% of total voltage excursion; for voltage setting from 0V to full scale and full scale to 0V)					
	20 ms	20 ms	20 ms	20 ms	20 ms
<b>Maximum Up-programming and Down-programming Settling Time with full resistive load:</b> (Time from start of voltage change to 0.1% of full-scale value; for voltage setting from 0V to full scale and full scale to 0V)					
	100 ms	100 ms	100 ms	100 ms	100 ms
<b>Over-voltage Protection:</b>					
Accuracy	0.25% +100 mV	0.25% + 130 mV	0.25% + 260 mV	0.25% + 650 mV	0.25% + 650 mV
With Option. 761	0.25% + 500 mV	0.25% + 350 mV	0.25% + 350 mV	0.25% + 650 mV	0.25% + 650 mV
With Option. 760	0.25% + 700 mV	0.25% + 700 mV	0.25% + 400 mV	0.25% + 650 mV	0.25% + 650 mV
Maximum setting	22 V	38.5 V	66 V	110 V	165 V
Response time	50 μs from occurrence of over-voltage condition to start of output shutdown				
<b>Output Ripple and Noise (PARD):</b>					
CC rms	6 mA	6 mA	6 mA	6 mA	6 mA
<b>Common Mode Noise:</b> (from 20 Hz – 20 MHz; from either output to chassis)					
Rms	2 mA	2 mA	2 mA	2 mA	2 mA
Peak-to- peak	< 20 mA	< 20 mA	< 20 mA	< 20 mA	< 20 mA
<b>Remote Sense Capability:</b>	Outputs can maintain specifications with up to a 1-volt drop per load lead. The load lead drop reduces the maximum available voltage at the load.				
<b>Series and Parallel Operation:</b>	Identically rated outputs can be operated directly in parallel or can be connected for straight series operation.				
<b>Minimum Output Turn-On Delay:</b> (Time from when any Output On command is received until the output starts turning on)					
Without relay	32 ms	32 ms	32 ms	32 ms	32 ms
With Option 760	58 ms	58 ms	58 ms	58 ms	58 ms

<sup>1</sup> Correction On compensates for current flowing into the output capacitor during voltage transients.

<sup>2</sup> Stated values apply when the load resistance is at or close to zero. To determine the frequency for larger resistance values, refer to the User's Guide under "Measurement System Bandwidth".

## Output Quadrant Characteristic

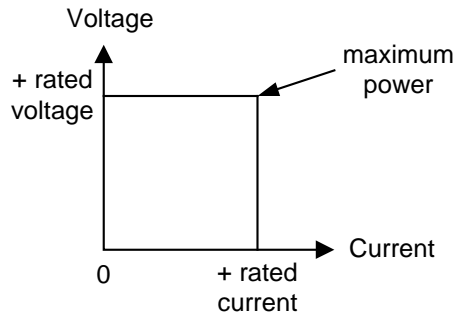

## Arbitrary Waveform Generator Maximum Bandwidth

### NOTE

The information in this section only applies when the power modules are installed in a Keysight N6705 DC Power Analyzer.

The following tables characterize the maximum bandwidth of the arbitrary waveform generator. The maximum bandwidth is based on a sine wave into a resistive load and applies to any output current. The following definitions apply in the frequency tables:

- V<sub>p-p</sub> = Voltage peak-to-peak
- 3 dB max. = Max. frequency where the voltage drops to 3 dB below its setting
- 6 dB max. = Max. frequency where the voltage drops to 6 dB below its setting
- THD 3 dB = The total harmonic distortion at 3 dB max. frequency
- THD 6 dB = The total harmonic distortion at 6 dB max. frequency

Voltage	3 dB max	THD 3 dB	6 dB max	THD 6 dB
<b>N6731B &amp; N6741B</b>				
0.1 V <sub>p-p</sub>	175 Hz	1.0%	260 Hz	3.0%
0.1 V <sub>p-p</sub>	125 Hz	1.0%	175 Hz	3.0%
0.3 V <sub>p-p</sub>	75 Hz	6.0%	100 Hz	6.0%
0.5 V <sub>p-p</sub>	40 Hz	9.0%	55 Hz	9.0%
5.0 V <sub>p-p</sub>	20 Hz	10%	37 Hz	10%
<b>N6732B &amp; N6742B</b>				
0.1 V <sub>p-p</sub>	125 Hz	1.0%	200 Hz	3.0%
0.2 V <sub>p-p</sub>	125 Hz	1.0%	180 Hz	3.0%
0.4 V <sub>p-p</sub>	75 Hz	6.0%	100 Hz	6.0%
0.8 V <sub>p-p</sub>	40 Hz	8.5%	60 Hz	8.5%
8.0 V <sub>p-p</sub>	20 Hz	10%	37 Hz	10%

**Arbitrary Waveform Generator Maximum Bandwidth (continued)**

<b>Voltage</b>	<b>3 dB max</b>	<b>THD 3 dB</b>	<b>6 dB max</b>	<b>THD 6 dB</b>	<b>3 dB max</b>	<b>THD 3 dB</b>	<b>6 dB max</b>	<b>THD 6 dB</b>
	<b>N6733B &amp; N6743B</b>				<b>N6773A</b>			
0.2 Vp-p	110 Hz	1.0%	190 Hz	3.0%	125 Hz	1.5%	210 Hz	4.0%
0.4 Vp-p	110 Hz	1.0%	160 Hz	3.0%	125 Hz	1.5%	180 Hz	4.0%
1.0 Vp-p	72 Hz	6.0%	95 Hz	6.0%	75 Hz	6.0%	95 Hz	6.0%
2.0 Vp-p	40 Hz	8.0%	55 Hz	8.5%	42 Hz	9.0%	60 Hz	9.0%
20 Vp-p	20 Hz	10%	37 Hz	10%	20 Hz	10%	37 Hz	10%
	<b>N6734B &amp; N6744B</b>				<b>N6774A</b>			
0.4 Vp-p	125 Hz	1.0%	200 Hz	1.0%	125 Hz	1.0%	200 Hz	1.0%
0.7 Vp-p	125 Hz	1.0%	175 Hz	3.5%	125 Hz	1.0%	160 Hz	3.0%
1.8 Vp-p	72 Hz	6.0%	100 Hz	6.0%	75 Hz	6.0%	95 Hz	6.0%
3.5 Vp-p	40 Hz	8.0%	55 Hz	8.5%	40 Hz	8.5%	55 Hz	8.5%
35 Vp-p	20 Hz	8.0%	37 Hz	8.5%	20 Hz	10%	37 Hz	10%
	<b>N6735B &amp; N6745B</b>				<b>N6775A</b>			
0.6 Vp-p	100 Hz	1.0%	180 Hz	1.0%	120 Hz	1.0%	200 Hz	1.0%
1.2 Vp-p	100 Hz	1.0%	160 Hz	3.0%	120 Hz	1.0%	160 Hz	3.0%
3.0 Vp-p	70 Hz	5.5%	92 Hz	5.5%	70 Hz	5.0%	95 Hz	6.0%
6.0 Vp-p	40 Hz	8.0%	55 Hz	8.0%	40 Hz	8.5%	55 Hz	8.5%
60 Vp-p	20 Hz	8.0%	37 Hz	8.0%	20 Hz	10%	35 Hz	10%
	<b>N6736B &amp; N6746B</b>				<b>N6776A</b>			
1.0 Vp-p	90 Hz	1.0%	160 Hz	1.5%	75 Hz	1.0%	160 Hz	1.0%
2.0 Vp-p	90 Hz	1.0%	150 Hz	3.0%	75 Hz	1.0%	150 Hz	3.0%
5.0 Vp-p	62 Hz	4.5%	85 Hz	6.0%	55 Hz	4.0%	75 Hz	6.0%
10 Vp-p	37 Hz	8.0%	50 Hz	8.0%	35 Hz	8.0%	45 Hz	8.0%
100 Vp-p	20 Hz	8.0%	35 Hz	8.0%	N/A	N/A	35 Hz	8.0%
					<b>N6777A</b>			
1.5 Vp-p					70 Hz	1.0%	150 Hz	1.0%
3.0 Vp-p					55 Hz	5.0%	120 Hz	2.0%
7.5 Vp-p					55 Hz	5.0%	70 Hz	6.0%
15 Vp-p					35 Hz	7.0%	55 Hz	7.0%
150 Vp-p					N/A	N/A	30 Hz	1.0%

# Chapter 3

## Keysight N675xA High Performance Power Modules

Performance Specifications.....	24
Supplemental Characteristics .....	25
Autoranging Characteristic.....	27
Output Impedance Graphs .....	27
Arbitrary Waveform Generator Maximum Bandwidth.....	30

Unless otherwise noted, specifications are warranted over the ambient temperature range of 0 to 40°C after a 30-minute warm-up period. Unless otherwise noted, accuracy is specified as percent of value + fixed offset.

Specifications apply at the output terminals, with each module's sense terminals internally connected to its output terminals (local sensing).

Refer to the Keysight N6700 or N6705 Service Guide for the setup conditions for all performance specifications.

Supplemental characteristics are not warranted but are descriptions of performance determined either by design or by type testing. All supplemental characteristics are typical unless otherwise noted.

# Performance Specifications

	N6751A/N6752A	N6753A/N6755A	N6754A/N6756A
<b>DC Output Ratings:</b>			
Voltage	0 - 50 V	0 - 20 V	0 - 60 V
Current <sup>NOTE 1</sup>	0 - 5 A / 0 - 10 A	0 - 50 A	0 - 20 A / 0 - 17A
Power	50 W / 100 W	300 W / 500 W	300 W / 500 W
<b>Output Ripple and Noise (PARD):</b> (from 20 Hz – 20 MHz)			
CV peak-to-peak	4.5 mV	5 mV	6 mV
CV rms	0.35 mV	1 mV	1 mV
<b>Load Effect (Regulation):</b> (Applies for any output load change, with a maximum load-lead drop of 1V/lead. The load lead drop reduces the maximum available voltage at the load.)			
Voltage	2 mV	2 mV	2 mV
Current	2 mA	12 mA	5 mA
<b>Source Effect (Regulation):</b>			
Voltage	1 mV	0.5 mV	1.2 mV
Current	1 mA	5 mA	2 mA
<b>Programming Accuracy:</b> (percent of value + offset; @ 23 °C ±5 °C after 30 minute warm-up. Applies from minimum to maximum programming range at any load.)			
Voltage	0.06% + 19 mV	0.06% + 10 mV	0.06% + 25 mV
Current	0.1% + 20 mA	0.1% + 30 mA	0.1% + 12 mA
<b>Voltmeter/Ammeter Measurement Accuracy:</b> (percent of value + offset; @ 23 °C ±5 °C. Applies when measuring the default value of 1024 data points with a 20.48 μs time interval.)			
Voltage	0.05% + 20 mV	0.05% + 10 mV	0.05% + 25 mV
Current	0.1% + 4 mA	0.1% + 30 mA	0.1% + 8 mA
<b>Load Transient Recovery Time:</b> (Time to recover to within the settling band following a load change - from 60% to 100% and from 100% to 60% of full load for model N6751A - from 50% to 100% and from 100% to 50% of full load for models N6752A through N6756A.)			
Settling band	± 75 mV <sup>NOTE 2</sup>	± 30 mV <sup>NOTE 3</sup>	± 90 mV <sup>NOTE 4</sup>
Time	< 100 μs	< 100 μs	< 100 μs

<sup>1</sup> Output current is derated 1% per °C above 40°C.

<sup>2</sup> When relay option 761 is installed on Model N6752A, the settling band is ±125 mV.

<sup>3</sup> When relay option 760 or 761 is installed on Model N6753A and N6755A, the settling band is ±200 mV.

<sup>4</sup> When relay option 760 or 761 is installed on Model N6754A and N6756A, the settling band is ±350 mV.



## Supplemental Characteristics

	N6751A / N6752A	N6753A / N6755A	N6754A / N6756A
<b>Programming Ranges:</b>			
Voltage	20 mV – 51 V	10 mV – 20.4 V	25 mV– 61.2 V
Current	10 mA – 5.1A/10 mA – 10.2A	50 mA – 51 A	20 mA – 20.4 A/20 mA – 17.3A
<b>Programming Resolution:</b>			
Voltage	3.5 mV	1.5 mV	4.2 mV
Current	3.25 mA	16.3 mA	6.5 mA
<b>Measurement Resolution:</b>			
Voltage	1.8 mV	0.8 mV	2.2 mV
Current	410 $\mu$ A	2.05 mA	0.82 mA
<b>Programming Temperature Coefficient per °C:</b>			
Voltage	18 ppm + 160 $\mu$ V	35 ppm + 100 $\mu$ V	35 ppm + 170 $\mu$ V
Current	100 ppm + 45 $\mu$ A	60 ppm + 500 $\mu$ A	60 ppm + 200 $\mu$ A
<b>Measurement Temperature Coefficient per °C:</b>			
Voltage	25 ppm + 35 $\mu$ V	50 ppm + 85 $\mu$ V	50 ppm + 100 $\mu$ V
Current	60 ppm + 3 $\mu$ A	60 ppm + 30 $\mu$ A	60 ppm + 12 $\mu$ A
<b>Measurement Small Signal Bandwidth: (– 3 db typical)</b>			
Voltage	10 kHz	10 kHz	10 kHz
Correction On <sup>NOTE 1</sup>	10 kHz	-	-
Current <sup>NOTE 2</sup>	10 kHz	10 kHz	10 kHz
Correction On <sup>NOTE 1</sup>	2 kHz	-	-
<b>N6705 Mainframe Oscilloscope Measurement Accuracy: (@ 23 °C <math>\pm</math>5 °C, accuracy of any individual point in the trace)</b>			
Voltage	0.05% + 32 mV	0.05% + 15 mV	0.05% + 37 mV
Current	0.1% + 8 mA	0.1% + 52 mA	0.1% + 17 mA
Correction On <sup>NOTE 1</sup>	0.1% + 14 mA	-	-
<b>Up-programming Time with full resistive load: (Time from 10% to 90% of total voltage excursion)</b>			
Small voltage step	0 V to 10 V	0 V to 6 V/0 V to 10 V	0 V to 15 V/0 V to 29 V
Time	0.2 ms	0.4 ms/0.5 ms	0.35 ms/0.7 ms
Large voltage step	0 V to 50 V	0 V to 20 V	0 V to 60 V
Time	1.5 ms	1.5 ms	2 ms
<b>Up-programming Settling Time with full resistive load: (Time from start of voltage change to 0.1% of full scale value)</b>			
Small voltage step	0 V to 10 V	0 V to 6 V/0 V to 10 V	0 V to 15 V/0 V to 29 V
Time	0.5 ms	0.8 ms/1.0 ms	0.8 ms/1.4 ms
Large voltage step	0 V to 50 V	0 V to 20 V	0 V to 60 V
Time	4 ms	3 ms	4.2 ms
<b>Down-programming Time with no load: (Time from start of voltage change to output voltage &lt; 0.5 V)</b>			
Small voltage step	10 V to 0 V	6 V to 0 V/10 V to 0 V	15 V to 0 V/29 V to 0 V
Time	0.3 ms	0.55 ms/1.0 ms	0.6 ms/1.2 ms
Large voltage step	50 V to 0 V	20 V to 0 V	60 V to 0 V
Time	1.3 ms	1.8 ms	2.2 ms

### Supplemental Characteristics (continued)

	N6751A / N6752A	N6753A / N6755A	N6754A / N6756A
<b>Down-programming Settling Time with no load:</b> (Time from start of voltage change to 0.1% of full scale value)			
Small voltage step	10 V to 0 V	6 V to 0 V/10 V to 0 V	15 V to 0 V/29 V to 0 V
Time	0.45 ms	0.8 ms/1.3 ms	0.8 ms/1.5 ms
Large voltage step	50 V to 0 V	20 V to 0 V	60 V to 0 V
Time	1.4 ms	2 ms	2.3 ms
<b>Down-programming Time with Capacitive load:</b> (Time from start of voltage change to output voltage < 0.5 V)			
Small voltage step	10 V to 0 V	6 V to 0 V/10 V to 0 V	15 V to 0 V/29 V to 0 V
Time	2.1 ms	2.2 ms/4.5 ms	2.3 ms/5.5 ms
Large voltage step	50 V to 0 V	20 V to 0 V	60 V to 0 V
Time	11 ms	8.5 ms	10 ms
Capacitive load <sup>NOTE 3</sup>	1000 $\mu$ F	4700 $\mu$ F	680 $\mu$ F
<b>Down-programming Capability:</b>			
Continuous power	7 W	12.5 W	12.5 W
Peak current	7 A	15 A	6 A
<b>Over-voltage Protection:</b>			
Accuracy	0.25% + 0.25 V	0.25% + 0.15V	0.25% + 0.3V
Accuracy with Option 761	0.25% + 0.25 V	0.25% + 0.45V	0.25% + 0.6V
Accuracy with Option 760	-	0.25% + 0.45V	0.25% + 0.6V
Maximum setting	55 V	22 V	66 V
Response time	50 $\mu$ s from occurrence of over-voltage condition to start of output shutdown		
<b>Output Ripple and Noise: (PARD)</b>			
CC rms:	2 mA	10 mA	4 mA
<b>Common Mode Noise: (from 20 Hz – 20 MHz; from either output to chassis)</b>			
rms	500 $\mu$ A	500 $\mu$ A	750 $\mu$ A
peak-to-peak	< 2 mA	< 2 mA	< 3 mA
<b>Remote Sense Capability:</b>	Outputs can maintain specifications with up to a 1-volt drop per load lead. The load lead drop reduces the maximum available voltage at the load.		
<b>Series and Parallel Operation:</b>	Identically rated outputs can be operated directly in parallel or can be connected for straight series operation..		
<b>Minimum Output Turn-On Delay:</b> (Time from when any Output On command is received until the output starts turning on)			
Without relay option	25 ms	18 ms	18 ms
With relay Option 760	51 ms	44 ms	44 ms

<sup>1</sup> Correction On compensates for current flowing into the output capacitor during voltage transients.

<sup>2</sup> Stated values apply when the load resistance is at or close to zero. To determine the frequency for larger resistance values, refer to the User's Guide under "Measurement System Bandwidth".

<sup>3</sup> Modules can discharge the specified capacitive load from full scale to 0V at a rate of 4 times/second.

# Autoranging Characteristic

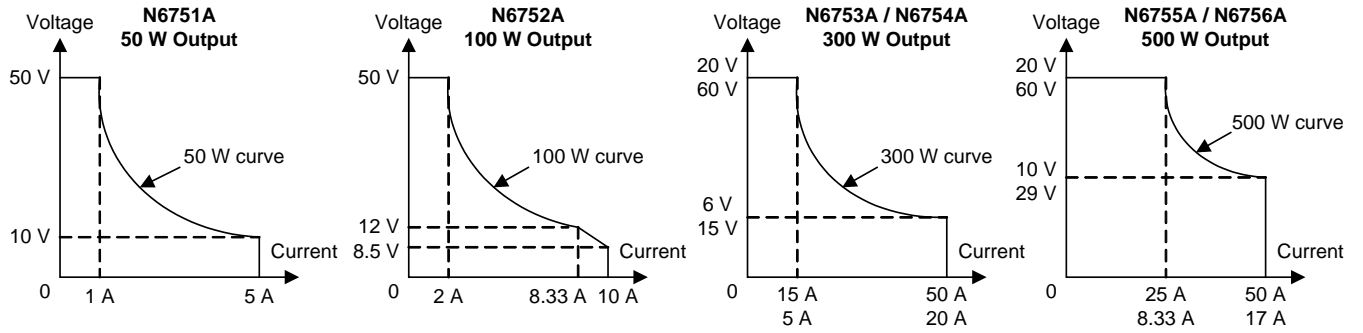

# Output Impedance Graphs

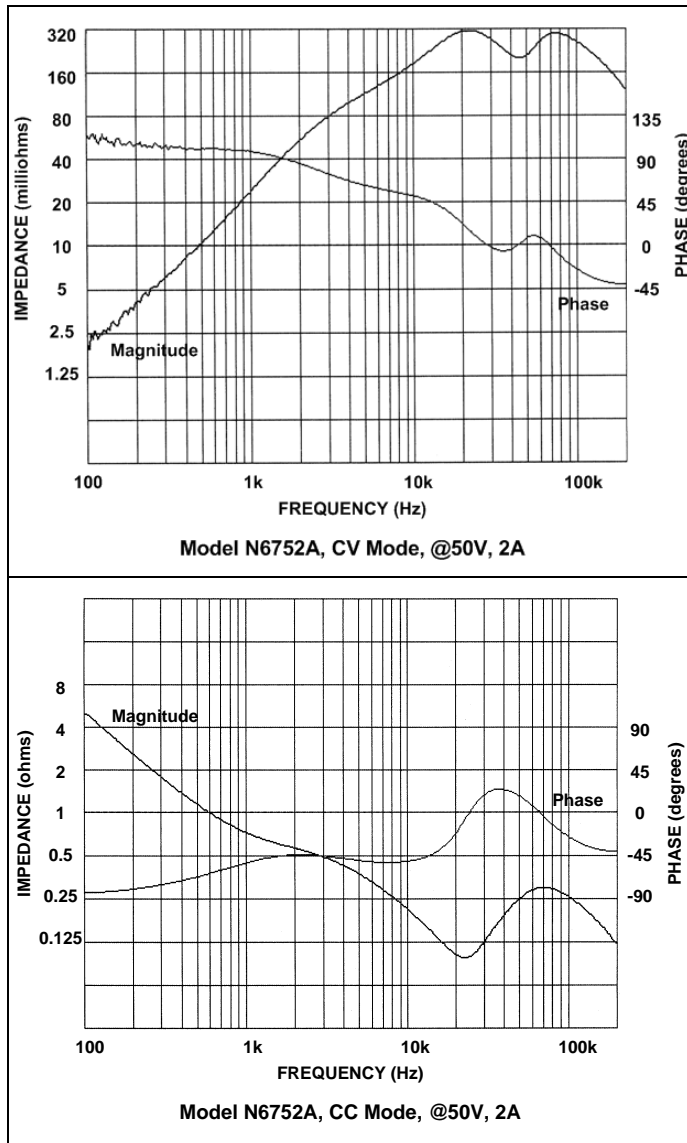

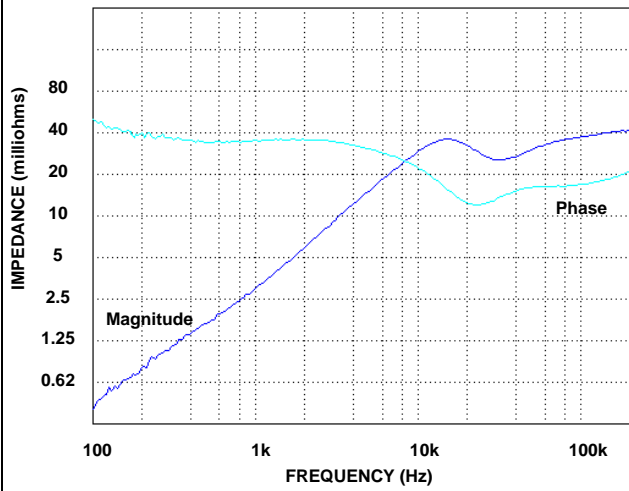

Model N6753A and N6755A, CV Mode, @20 V, 15A

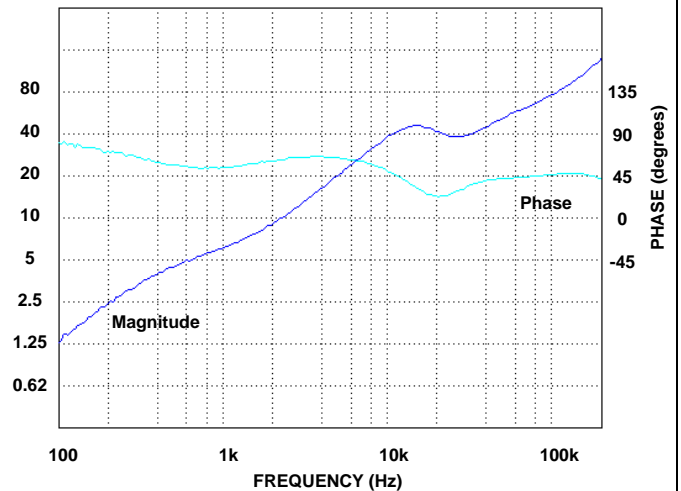

Model N6753A and N6755A, Option 760, CV Mode, @20 V, 15A

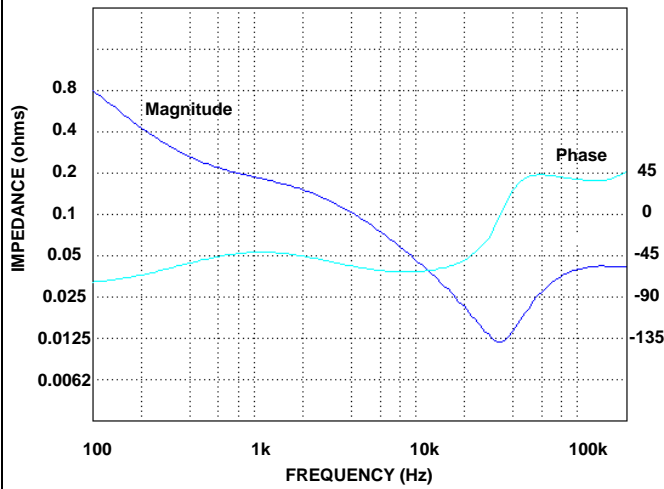

Model N6753A and N6755A, CC Mode, @20 V, 15A

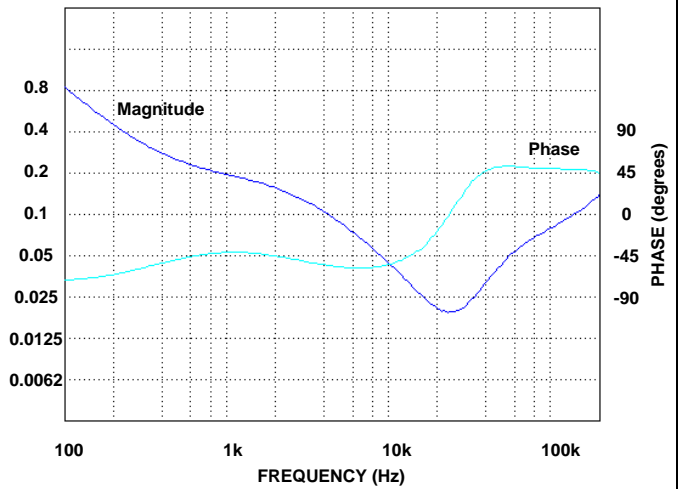

Model N6753A and N6755A, Option 760, CC Mode, @20 V, 15A

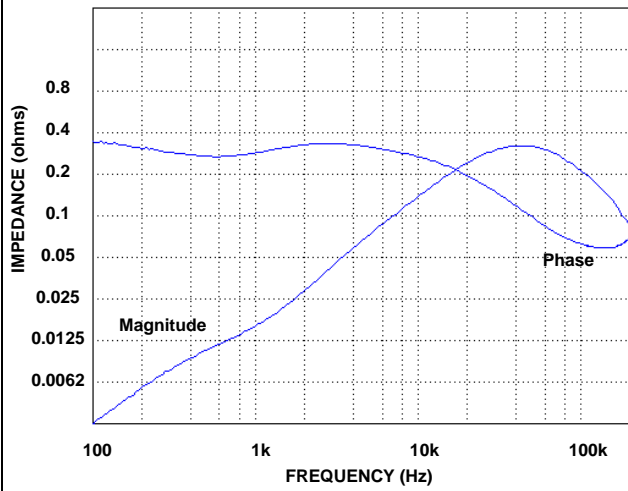

Model N6754A and N6756A, CV Mode, @60 V, 5A

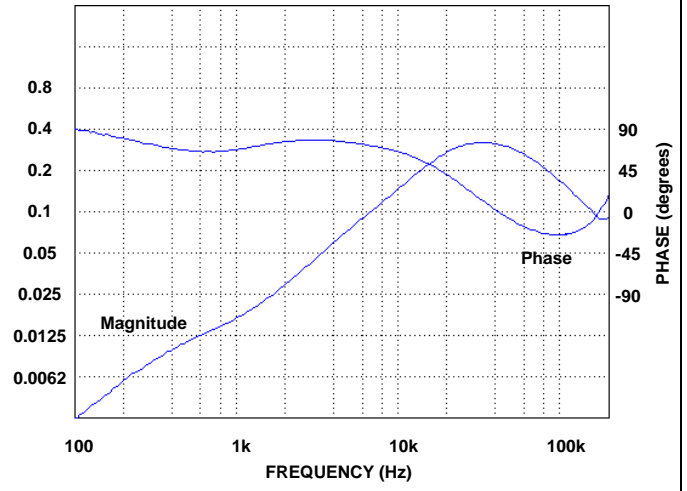

Model N6754A and N6756A, Option 760, CV Mode, @60 V, 5A

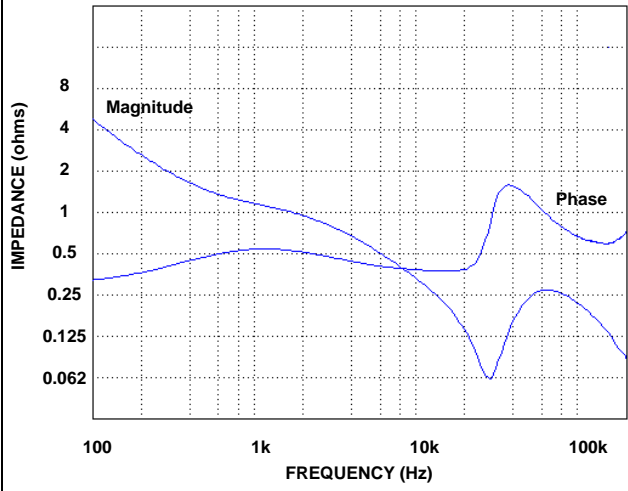

Model N6754A and N6756A, CC Mode, @60 V, 5A

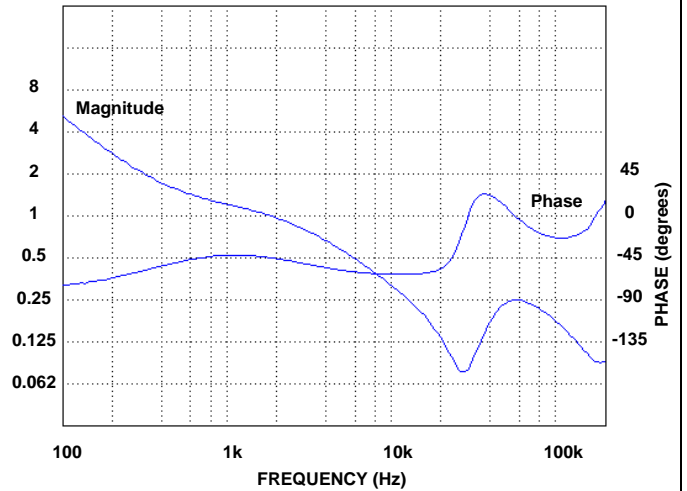

Model N6754A and N6756A, Option 760, CC Mode, @60 V, 5A

## Arbitrary Waveform Generator Maximum Bandwidth

**NOTE**

The information in this section only applies when the power modules are installed in a Keysight N6705 DC Power Analyzer.

The following tables characterize the maximum bandwidth of the arbitrary waveform generator. The maximum bandwidth is based on a sine wave into a resistive load and applies to any output current. The following definitions apply in the frequency tables:

- V<sub>p-p</sub> = Voltage peak-to-peak
- 3 dB max. = Max. frequency where the voltage drops to 3 dB below its setting
- THD 3 dB = The total harmonic distortion at 3 dB max. frequency
- THD < 1.5% = The frequency below which the THD is less than 1.5%.

Voltage	3 dB max	THD 3 dB	THD < 1.5%
<b>N6751A &amp; N6752A</b>			
0.5 V <sub>p-p</sub>	4000 Hz	12%	440 Hz
1.0 V <sub>p-p</sub>	2200 Hz	21%	440 Hz
2.5 V <sub>p-p</sub>	900 Hz	25%	265 Hz
5.0 V <sub>p-p</sub>	500 Hz	27%	160 Hz
50.0 V <sub>p-p</sub>	340 Hz	22%	25 Hz
<b>N6753A &amp; N6755A</b>			
0.2 V <sub>p-p</sub>	2300 Hz	10%	1300 Hz
0.4 V <sub>p-p</sub>	1500 Hz	15%	800 Hz
1.0 V <sub>p-p</sub>	980 Hz	19%	480 Hz
2.0 V <sub>p-p</sub>	580 Hz	21%	300 Hz
20.0 V <sub>p-p</sub>	400 Hz	12%	32 Hz
<b>N6754A &amp; N6756A</b>			
0.6 V <sub>p-p</sub>	2800 Hz	8.0%	1600 Hz
1.2 V <sub>p-p</sub>	1400 Hz	15%	800 Hz
3.0 V <sub>p-p</sub>	600 Hz	17%	300 Hz
6.0 V <sub>p-p</sub>	400 Hz	20%	200 Hz
60.0 V <sub>p-p</sub>	344 Hz	12%	30 Hz

# Chapter 4

## Keysight N676xA Precision Power Modules

Performance Specifications.....	32
Supplemental Characteristics .....	33
Autoranging Characteristic.....	35
Output Impedance Graphs .....	35
Arbitrary Waveform Generator Maximum Bandwidth.....	37

Unless otherwise noted, specifications are warranted over the ambient temperature range of 0 to 40°C after a 30-minute warm-up period. Unless otherwise noted, accuracy is specified as percent of value + fixed offset.

Specifications apply at the output terminals, with each module's sense terminals internally connected to its output terminals (local sensing).

Refer to the Keysight N6700 or N6705 Service Guide for the setup conditions for all performance specifications.

Supplemental characteristics are not warranted but are descriptions of performance determined either by design or by type testing. All supplemental characteristics are typical unless otherwise noted.

## Performance Specifications

	N6761A/N6762A	N6763A/N6765A	N6764A/N6766A
<b>DC Ratings:</b>			
Voltage	0 - 50 V	0 - 20 V	0 - 60 V
Current <sup>NOTE 1</sup>	0 - 1.5 A / 0 - 3 A	0 - 50 A	0 - 20 A / 0 - 17 A
Power	50 W / 100 W	300 W / 500 W	300 W / 500 W
Low programming ranges (V & I)	5.5 V; 100 mA	-	-
Low measurement ranges (V & I)	5.5 V; 100 mA	2 V; 1.5 A	6 V; 0.5 A
<b>Output Ripple and Noise (PARD):</b> (from 20 Hz - 20 MHz)			
CV peak-to-peak	4.5 mV	5 mV	6 mV
CV rms	0.35 mV	1 mV	1 mV
<b>Load Effect (Regulation):</b> (Applies for any output load change, with a maximum load-lead drop of 1V/lead. The load lead drop reduces the maximum available voltage at the load.)			
Voltage	0.5 mV	2 mV	2 mV
Current	30 $\mu$ A (@ 0 - 7 V) 65 $\mu$ A (@ 7 - 50V)	12 mA	5 mA
<b>Source Effect (Regulation):</b>			
Voltage	0.5 mV	0.5 mV	1.2 mV
Current	30 $\mu$ A	5 mA	2 mA
<b>Programming Accuracy:</b> (@ 23 °C $\pm$ 5 °C after 30 minute warm-up. Applies from minimum to maximum programming range at any load.)			
Voltage, high range	0.016% + 6 mV	0.03% + 5 mV	0.03% + 12 mV
Voltage, low range	0.016% + 1.5 mV	-	-
Current, high range	0.04% + 200 $\mu$ A	0.1% + 15 mA	0.075% + 4 mA
Current, low range	0.04% + 30 $\mu$ A (@ 0 - 7 V) 0.04% + 55 $\mu$ A (@ 7 - 50 V)	-	-
<b>Voltmeter/Ammeter Measurement Accuracy:</b> (@ 23 °C $\pm$ 5 °C) Applies when measuring 4096 data points with a 20.48 $\mu$ s time interval.)			
Voltage, high range	0.016% + 6 mV	0.03% + 10 mV	0.03% + 25 mV
Voltage, low range	0.016% + 1.5 mV	0.03% + 1.5 mV	0.03% + 5 mV
Current, high range	0.04% + 160 $\mu$ A	0.1% + 10 mA	0.1% + 5 mA
Current, low range	0.03% + 15 $\mu$ A (@ 0 - 7 V) 0.03% + 55 $\mu$ A (@ 7 - 50 V)	0.05% + 1.1 mA <sup>NOTE 2</sup>	0.05% + 0.75 mA <sup>NOTE 2</sup>
200 $\mu$ A current range (Option 2UA)	0.5% + 100 nA	-	-
<b>Load Transient Recovery Time:</b> (time to recover to within the settling band following a load change - from 60% to 100% and from 100% to 60% of full load for model N6761A - from 50% to 100% and from 100% to 50% of full load for model N6762A through N6766A)			
Settling band	$\pm$ 75 mV	$\pm$ 30 mV <sup>NOTE 3</sup>	$\pm$ 90 mV <sup>NOTE 4</sup>
Time	< 100 $\mu$ s	< 100 $\mu$ s	< 100 $\mu$ s

<sup>1</sup> Output current is derated 1% per °C above 40°C.

<sup>2</sup> Applies when measuring currents that remain within the low range. Due to thermal settling, when transitioning from measuring full-rated output current (the worst case), to measuring the current within the low range, the low range accuracy specification is typically met within 5 seconds after the current has transitioned into the low range. Accuracies within this 5 second settling period are typically 2X the specified accuracy or better.

<sup>3</sup> When relay option 760 or 761 is installed on Models N6763A and N6765A, the settling band is  $\pm$ 200 mV.

<sup>4</sup> When relay option 760 or 761 is installed on Models N6764A and N6766A, the settling band is  $\pm$ 350 mV.



## Supplemental Characteristics

	N6761A / N6762A	N6763A / N6765A	N6764A / N6766A
<b>Programming Ranges:</b>			
Voltage, high range	15 mV – 51 V	10 mV – 20.4 V	25 mV– 61.2 V
Voltage, low range	12 mV – 5.5 V	-	-
Current, high range	1 mA–1.53 A/1 mA–3.06 A	50 mA – 51 A	20 mA–20.4A/20mA–17.3A
Current, low range <sup>NOTE 1</sup>	0.1 mA – 0.1 A	-	-
<b>Programming Resolution:</b>			
Voltage, high range	880 $\mu$ V	1.5 mV	4.2 mV
Voltage, low range	90 $\mu$ V	-	-
Current, high range	60 $\mu$ A	16.3 mA	6.5 mA
Current, low range	2 $\mu$ A	-	-
<b>Measurement Resolution:</b>			
Voltage, high range	440 $\mu$ V	250 $\mu$ V	600 $\mu$ V
Voltage, low range	44 $\mu$ V	25 $\mu$ V	60 $\mu$ V
Current, high range	30 $\mu$ A	500 $\mu$ A	250 $\mu$ A
Current, low range	1 $\mu$ A	20 $\mu$ A	10 $\mu$ A
200 $\mu$ A current range (Option 2UA)	4 nA	-	-
<b>Programming Temperature Coefficient per °C:</b>			
Voltage, high range	18 ppm + 140 $\mu$ V	23 ppm + 95 $\mu$ V	23 ppm + 218 $\mu$ V
Voltage, low range	40 ppm + 70 $\mu$ V	-	-
Current, high range	33 ppm + 10 $\mu$ A	25ppm + 129 $\mu$ A	25ppm + 52 $\mu$ A
Current, low range	60 ppm + 1.5 $\mu$ A	-	-
<b>Measurement Temperature Coefficient per °C:</b>			
Voltage, high range	23 ppm + 40 $\mu$ V	23 ppm + 53 $\mu$ V	23 ppm + 73 $\mu$ V
Voltage, low range	30 ppm + 40 $\mu$ V	25 ppm + 53 $\mu$ V	25 ppm + 73 $\mu$ V
Current, high range	40 ppm + 0.3 $\mu$ A	25 ppm + 21 $\mu$ A	25 ppm + 7 $\mu$ A
Current, low range	50 ppm + 0.3 $\mu$ A	27 ppm + 21 $\mu$ A	27 ppm + 7 $\mu$ A
Current, 200 $\mu$ A range (Option 2UA)	100 ppm + 3 nA/°C	-	-
<b>Measurement Small Signal Bandwidth: (- 3 db typical)</b>			
Voltage	10 kHz	10 kHz	10 kHz
Correction On <sup>NOTE 2</sup>	10 kHz	-	-
Current <sup>NOTE 3</sup>	10 kHz	10 kHz	10 kHz
Correction On <sup>NOTE 2</sup>	2 kHz	-	-
<b>N6705 Mainframe Oscilloscope Measurement Accuracy: (@ 23 °C <math>\pm</math>5 °C, accuracy of any individual point in the trace)</b>			
Voltage	0.016% + 16 mV	0.03% + 13 mV	0.03% + 32 mV
Current, high range	0.04% + 1 mA	0.1% + 16 mA	0.1% + 8.4 mA
Correction On <sup>NOTE 2</sup>	0.04% + 10 mA	-	-
Current, low range	0.03% + 0.175 mA	0.05% + 6.6 mA	0.05% + 2.6 mA
<b>Up-programming Time with full resistive load: (Time from 10% to 90% of total voltage excursion)</b>			
Small voltage step	0 V to 10 V	0 V to 6 V/0 V to 10 V	0 V to 15 V/0 V to 29 V
Time	0.6 ms	0.4 ms/0.5 ms	0.35 ms/0.7 ms
Large voltage step	0 V to 50 V	0 V to 20 V	0 V to 60 V
Time	2.2 ms	1.5 ms	2 ms

## Supplemental Characteristics (continued)

	N6761A / N6762A	N6763A / N6765A	N6764A / N6766A
<b>Up-programming Settling Time with full resistive load:</b> (Time from start of voltage change to 0.1% of full scale value)			
Small voltage step	0 V to 10 V	0 V to 6 V/0 V to 10 V	0 V to 15 V/0 V to 29 V
Time	0.9 ms	0.8 ms/1.0 ms	0.8 ms/1.4 ms
Large voltage step	0 V to 50 V	0 V to 20 V	0 V to 60 V
Time	4 ms	3 ms	4.2 ms
<b>Down-programming Time with no load:</b> (time from start of voltage change to output voltage < 0.5 V)			
Small voltage step	10 V to 0 V	6 V to 0 V/10 V to 0 V	15 V to 0 V/29 V to 0 V
Time	0.3 ms	0.55 ms/1.0 ms	0.6 ms/1.2 ms
Large voltage step	50 V to 0 V	20 V to 0 V	60 V to 0 V
Time	1.3 ms	1.8 ms	2.2 ms
<b>Down-programming Settling Time with no load:</b> (time from start of voltage change to 0.1% of full scale value)			
Small voltage step	10 V to 0 V	6 V to 0 V/10 V to 0 V	15 V to 0 V/29 V to 0 V
Time	0.45 ms	0.8 ms/1.3 ms	0.8 ms/1.5 ms
Large voltage step	50 V to 0 V	20 V to 0 V	60 V to 0 V
Time	1.4 ms	2 ms	2.3 ms
<b>Down-programming Time with Capacitive load:</b> (time from start of voltage change to output voltage < 0.5 V)			
Small voltage step	10 V to 0 V	6 V to 0 V/10 V to 0 V	15 V to 0 V/29 V to 0 V
Time	4.5 ms	2.2 ms/4.5 ms	2.3 ms/5.5 ms
Large voltage step	50 V to 0 V	20 V to 0 V	60 V to 0 V
Time	23 ms	8.5 ms	10 ms
Capacitive load <sup>NOTE 4</sup>	1000 $\mu$ F	4700 $\mu$ F	680 $\mu$ F
<b>Down-programming Capability:</b>			
Continuous power	7 W	12.5 W	12.5 W
Peak current	3.8 A	15 A	6 A
<b>Over-voltage Protection:</b>			
Accuracy	0.25% + 0.25 V	0.25% + 0.15 V	0.25% + 0.3 V
With Option 761	0.25% + 0.25 V	0.25% + 0.45 V	0.25% + 0.6 V
With Option 760	-	0.25% + 0.45 V	0.25% + 0.6 V
Maximum setting	55 V	22 V	66 V
Response time	50 $\mu$ s from occurrence of over-voltage condition to start of output shutdown		
<b>Output Ripple and Noise: (PARD)</b>			
CC rms:	2 mA	10 mA	4 mA
<b>Common Mode Noise: (from 20 Hz – 20 MHz; from either output to chassis)</b>			
rms	500 $\mu$ A	500 $\mu$ A	750 $\mu$ A
peak-to-peak	< 2 mA	< 2 mA	< 3 mA
<b>Remote Sense Capability:</b> Outputs can maintain specifications with up to a 1-volt drop per load lead. The load lead drop reduces the maximum available voltage at the load.			
<b>Series and Parallel Operation:</b> Identically rated outputs can be operated directly in parallel or can be connected for straight series operation.			
<b>Minimum Output Turn-On Delay:</b> (Time from when any Output On command is received until the output starts turning on)			
Without relay option	32 ms <sup>NOTE 5</sup>	18 ms	18 ms
With relay Option 760	58 ms <sup>NOTE 5</sup>	44 ms	44 ms

<sup>1</sup> If you are operating the unit below 255  $\mu$ A in constant current mode, the output may become unregulated with the following load conditions: The load resistance is < 175 m $\Omega$  and the load inductance is > 20  $\mu$ H. If this occurs, an UNRegulated flag will be generated and the output current may rise above the programmed value but will remain < 255  $\mu$ A.

<sup>2</sup> Correction On compensates for current flowing into the output capacitor during voltage transients

<sup>3</sup> Stated values apply when the load resistance is at or close to zero. To determine the frequency for larger resistance values, refer to the User's Guide under "Measurement System Bandwidth".

<sup>4</sup> Modules can discharge the specified capacitive load from full scale to 0V at a rate of 4 times/second.

<sup>5</sup> In Current turn-on preferred mode, minimum delay is 23 ms without relays and 45 ms with relay Option 760.

# Autoranging Characteristic

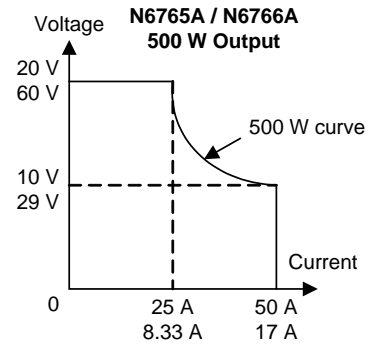
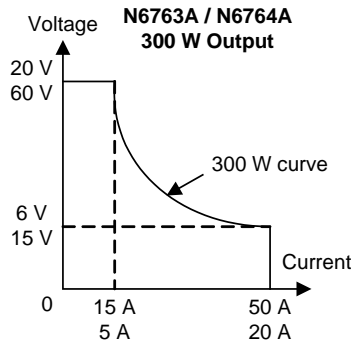
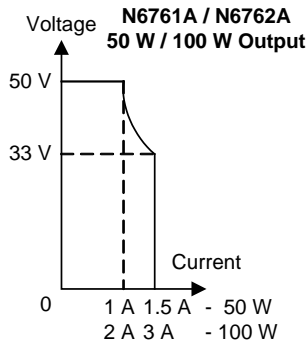

# Output Impedance Graphs

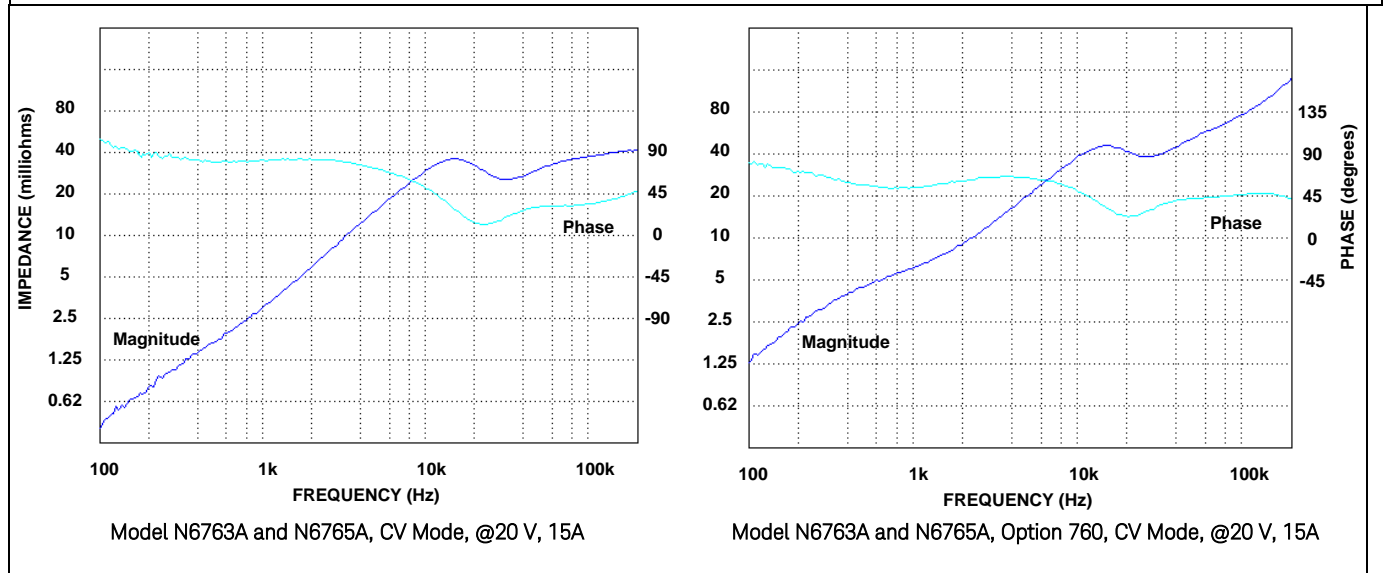
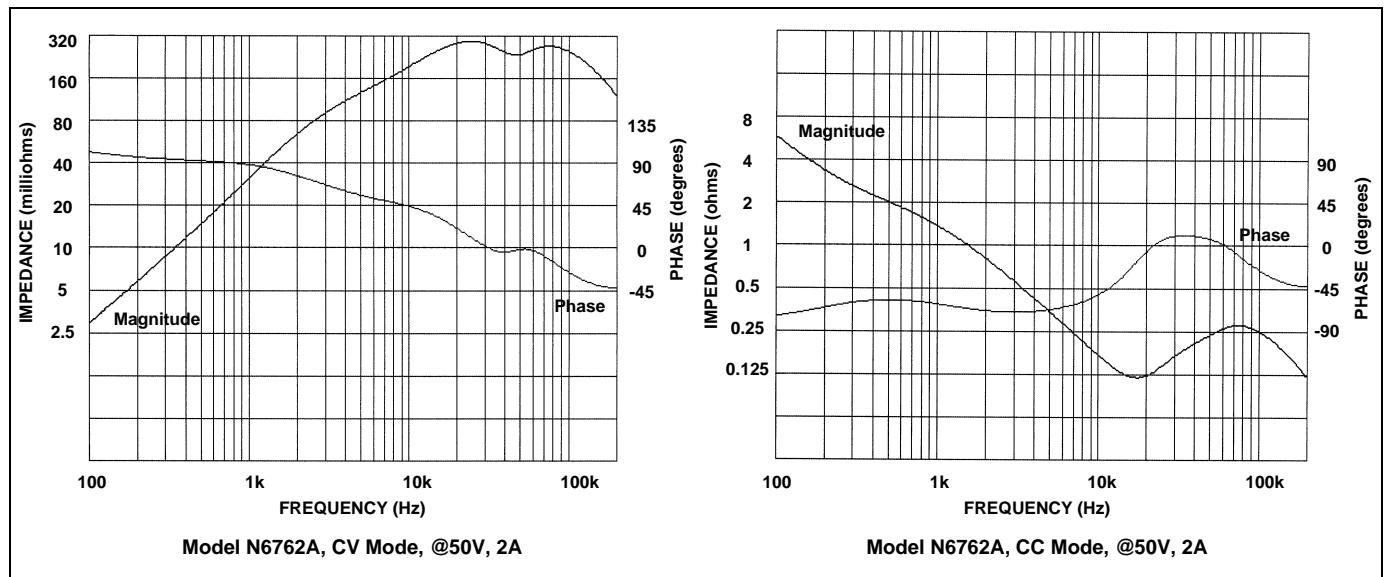

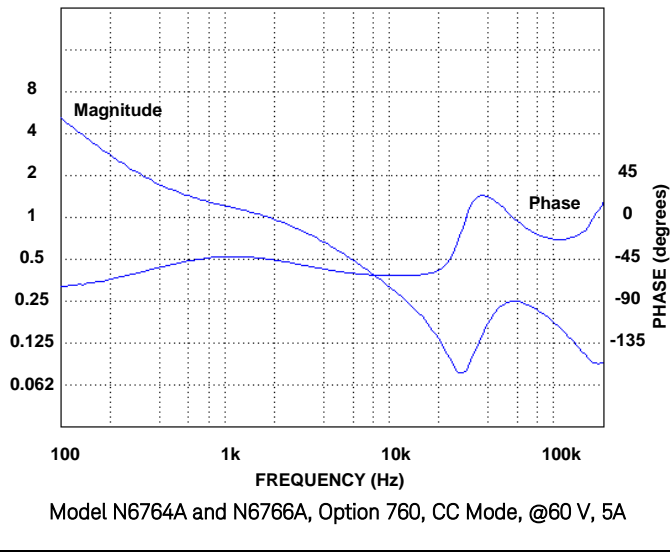
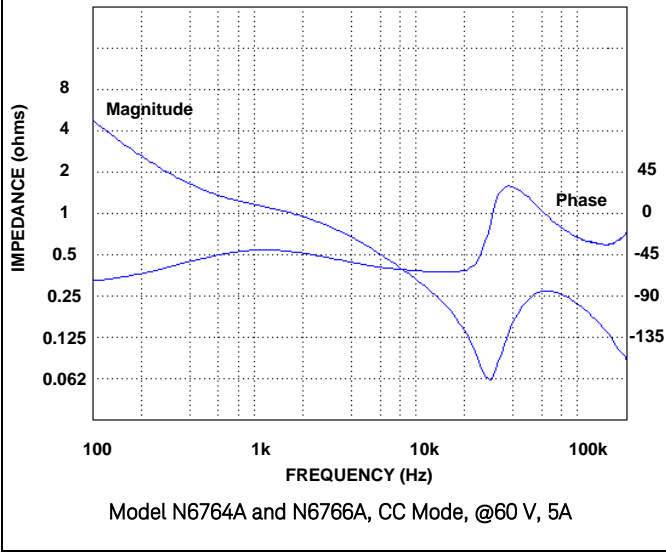
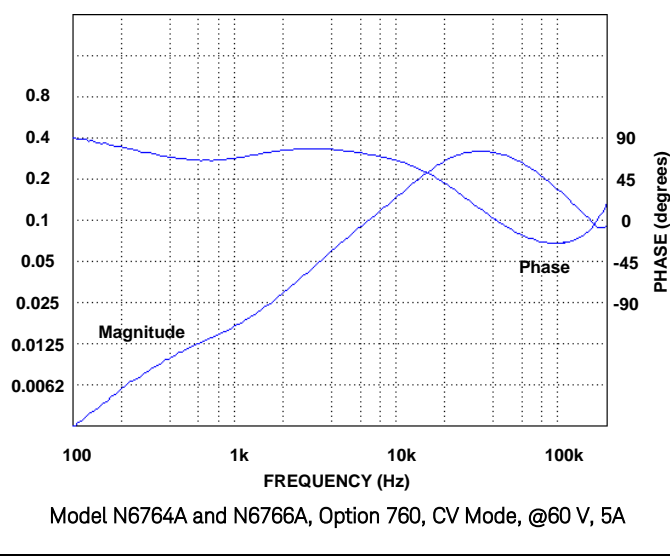
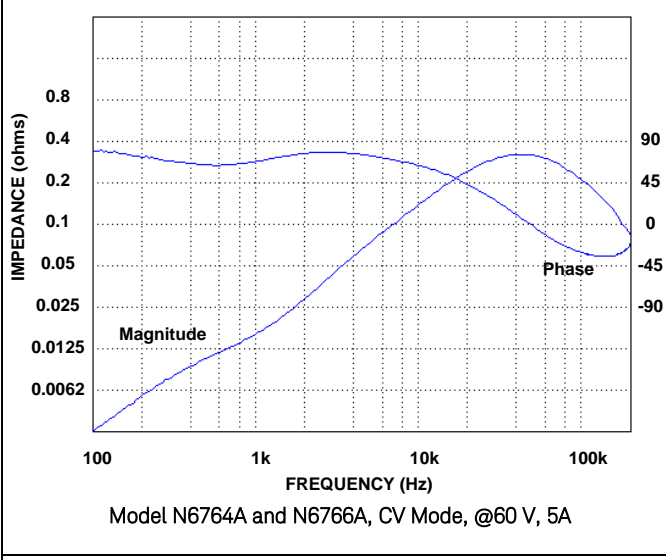
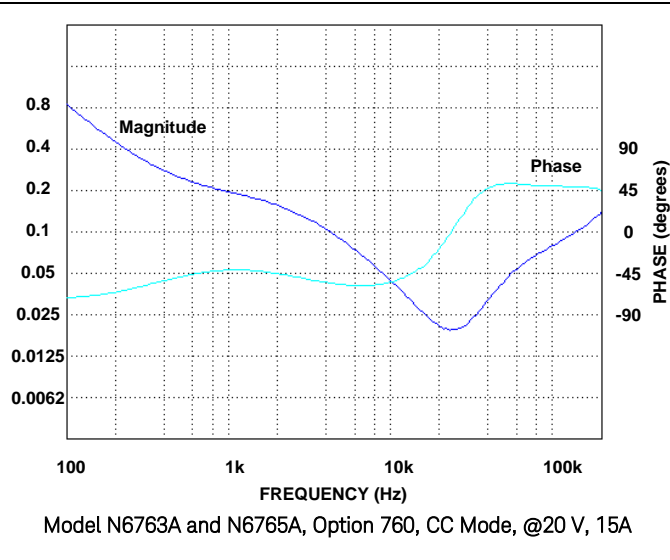
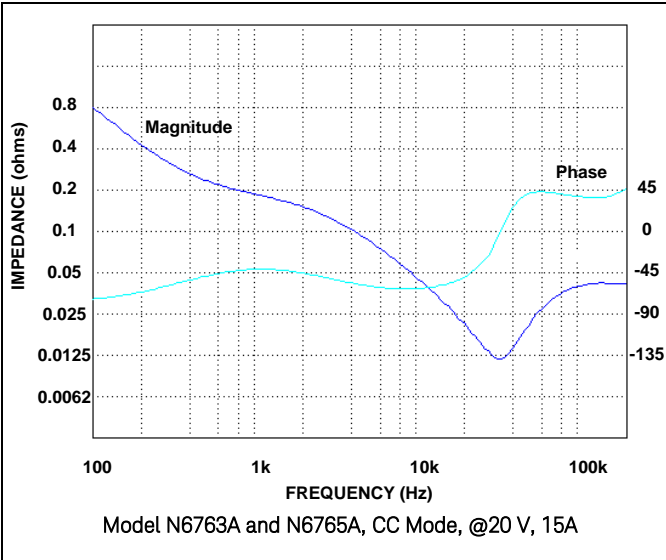

## Arbitrary Waveform Generator Maximum Bandwidth

**NOTE**

The information in this section only applies when the power modules are installed in a Keysight N6705 DC Power Analyzer.

The following tables characterize the maximum bandwidth of the arbitrary waveform generator. The maximum bandwidth is based on a sine wave into a resistive load and applies to any output current. The following definitions apply in the frequency tables:

- V<sub>p-p</sub> = Voltage peak-to-peak
- 3 dB max. = Max. frequency where the voltage drops to 3 dB below its setting
- THD 3 dB = The total harmonic distortion at 3 dB max. frequency
- THD < 1.5% = The frequency below which the THD is less than 1.5%.

Voltage	3 dB max	THD 3 dB	THD < 1.5%
<b>N6761A &amp; N6762A</b>			
0.5 V <sub>p-p</sub>	4500 Hz	14%	450 Hz
1.0 V <sub>p-p</sub>	3600 Hz	14%	450 Hz
2.5 V <sub>p-p</sub>	1300 Hz	25%	340 Hz
5.0 V <sub>p-p</sub>	600 Hz	25%	250 Hz
50.0 V <sub>p-p</sub>	350 Hz	22%	30 Hz
<b>N6763A &amp; N6765A</b>			
0.2 V <sub>p-p</sub>	2300 Hz	10%	1300 Hz
0.4 V <sub>p-p</sub>	1500 Hz	15%	800 Hz
1.0 V <sub>p-p</sub>	980 Hz	19%	480 Hz
2.0 V <sub>p-p</sub>	580 Hz	21%	300 Hz
20.0 V <sub>p-p</sub>	400 Hz	12%	32 Hz
<b>N6764A &amp; N6766A</b>			
0.6 V <sub>p-p</sub>	2800 Hz	8.0%	1600 Hz
1.2 V <sub>p-p</sub>	1400 Hz	15%	800 Hz
3.0 V <sub>p-p</sub>	600 Hz	17%	300 Hz
6.0 V <sub>p-p</sub>	400 Hz	20%	200 Hz
60.0 V <sub>p-p</sub>	344 Hz	12%	30 Hz



# Chapter 5

## Keysight N678xA Source/Measure Units

Performance Specifications.....	40
Supplemental Characteristics .....	42
Output Quadrant Characteristic .....	47
Output Impedance Graphs .....	48
Voltage Programming Response.....	50
Measurement Accuracy and Resolution .....	52

Unless otherwise noted, specifications are warranted over the ambient temperature range of 0 to 30°C after a 30-minute warm-up period. Unless otherwise noted, accuracy is specified as percent of value + fixed offset.

Unless otherwise noted, specifications apply at the mainframe output terminals, with each module's sense terminals internally connected to its output terminals (local sensing).

Refer to the Keysight N6700 or N6705 Service Guide for the setup conditions for all performance specifications.

Supplemental characteristics are not warranted but are descriptions of performance determined either by design or by type testing. All supplemental characteristics are typical unless otherwise noted.

# Performance Specifications

	N6781A / N6782A	N6784A	N6785A / N6786A
<b>DC Ratings:</b>			
Voltage	20 V/6 V	±20 V/± 6 V	20 V/15 V/10 V/6 V
Current <sup>NOTE 1</sup>	± 1 A/± 3 A	± 1 A/± 3 A	± 4 A/± 5 A/± 6.7 A/± 8 A
Power	20 W	20 W	80 W
Auxiliary Voltage Measurement Input <sup>NOTE 2</sup>	± 20 V	-	± 20 V
<b>Output Voltage Ripple &amp; Noise (PARD) from 20 Hz – 20 MHz:</b>			
Measured at the output terminals, under all load conditions, in Voltage Priority mode. Output Bandwidth setting = Low			
CV peak-to-peak	12 mV	12 mV	15 mV
CV rms	1.2 mV	1.2 mV	1.5 mV
<b>Load Effect (Load regulation):</b>			
For any load change, with a load drop of 1.0 V. The load lead drop reduces the maximum available voltage at the load.			
Voltage, 20 V range	700 µV	700 µV	700 µV
Voltage, 15 V & 10 V ranges	-	-	700 µV
Voltage, 6 V range	400 µV	400 µV	700 µV
Current, 8 A, 6.7 A, 5 A, & 4 A ranges	-	-	400 µA
Current, 3 A range	100 µA	100 µA	-
Current, 1 A range	50 µA	50 µA	-
Current, 300 mA ranges <sup>NOTE 3</sup>	50 µA	-	-
Current, 100 mA & 10 mA ranges <sup>NOTE 3</sup>	-	1 µA	-
<b>Source Effect (Line regulation):</b>			
Source Effect is guaranteed by design. Refer to “Supplemental Characteristics” later in this chapter.			
<b>Programming Accuracy @ 23 °C ±5 °C:</b>			
After a 30 minute warm-up. Applies from minimum to maximum programming range at any load.			
Voltage, 20 V range	0.025% + 1.8 mV	0.025% + 1.8 mV	0.025% + 1.8 mV
Voltage, 15 V & 10 V ranges	-	-	0.025% + 1.8 mV
Voltage, 6V range	0.025% + 600 µV	0.025% + 600 µV	0.025% + 1.8 mV
Voltage, 600 mV range <sup>NOTE 3</sup>	0.025% + 200 µV	0.025% + 200 µV	-
Current, 8 A, 6.7 A, 5 A, & 4 A ranges	-	-	0.04% + 1.5 mA
Current, 3 A & 1 A ranges	0.04% + 300 µA	0.04% + 300 µA	-
Current, 300 mA range <sup>NOTE 3</sup>	0.03% + 150 µA	-	-
Current, 100 mA range <sup>NOTE 3</sup>	-	0.03% + 12 µA	-
Current, 10 mA range <sup>NOTE 3</sup>	-	0.025% + 5 µA	-
Resistance for 20 V output range <sup>NOTE 2</sup>	0.1% + 3 mΩ	-	0.1% + 1 mΩ
Resistance for 15 V & 10 V ranges <sup>NOTE 2</sup>	-	-	0.1% + 1 mΩ
Resistance for 6 V output range <sup>NOTE 2</sup>	0.1% + 1.5 mΩ	-	0.1% + 1 mΩ



## Performance Specifications (continued)

	N6781A / N6782A	N6784A	N6785A / N6786A
<b>Measurement Accuracy @ 23 °C ±5 °C:</b>			
Applies when measuring the default value of 4883 data points with a 20.48 μs time interval. Refer to “Measurement Accuracy and Resolution” later in this chapter for more information.			
Voltage, 20 V range	0.025% + 1.2 mV	0.025% + 1.2 mV	0.025% + 1.8 mV
Voltage, 1 V range	0.025% + 75 μV	0.025% + 75 μV	-
Voltage, 100 mV range	0.025% + 50 μV	0.025% + 50 μV	-
Auxiliary Voltage Measurement Input <sup>NOTE 2</sup>	0.025% + 5 mV	-	0.025% + 5 mV
Current, 8 A range	-	-	0.04% + 1.5 mA
Current, 3 A range	0.03% + 250 μA	0.03% + 250 μA	-
Current, 100 mA range	0.025% + 10 μA	0.025% + 10 μA	0.025% + 10 μA
Current, 1 mA range	0.025% + 100 nA	0.025% + 100 nA	0.025% + 100 nA
Current, 10 μA range	0.025% + 8 nA	0.025% + 8 nA	-
<b>Load Transient Response Time in Voltage Priority mode:</b>			
Time to recover to within the settling band.			
With 150μF cap (ESR=50 mΩ) at load, remote sensing at cap, 4.25' twisted pair load leads-See Service Guide for setup info.			
Rise time (10% to 90%)	10 μs	10 μs	10 μs
Settling band			
20 V range with a 0.8 A load step	± 10 mV	± 10 mV	± 20 mV <sup>NOTE 4</sup>
15 V & 10 V range with a 1.4 A load step	-	-	± 20 mV
6 V range with a 1.4 A load step	± 20 mV	± 20 mV	± 20 mV
Recovery time	≤ 35 μs	≤ 35 μs	≤ 35 μs

<sup>1</sup> Output current is derated 1% per °C above 30°C.

<sup>2</sup> Applies to N6781A and N6785A only.

Add an additional voltage programming error of 1 mV/Ω for N6781A and 10 mV/Ω for N6785A is also present.

<sup>3</sup> 600 mV range is only available in Voltage Priority mode;

300 mA, 100 mA, 10 mA ranges are only available in Current Priority mode.

<sup>4</sup> Applies with a 1.4 A load step.

## Supplemental Characteristics

	N6781A / N6782A	N6784A	N6785A / N6786A
<b>Minimum Current and Voltage Compliance limits:</b>			
20 V range Voltage Priority mode	10 mA	10 mA	8 mA
10 V & 15 V ranges Voltage Priority mode	-	-	8 mA
6 V range Voltage Priority mode	20 mA	20 mA	8 mA
8 A, 6.7 A, 5 A, & 4 A ranges Current Priority	-	-	20 mV
3 A range Current Priority mode	10 mV	10 mV	-
1 A range Current Priority mode	20 mV	20 mV	-
<b>Programming Range &amp; Resolution:</b>			
Voltage, 20 V range	0 to 20.4 V; 200 $\mu$ V	-20.4 V to 20.4 V; 200 $\mu$ V	0 to 20.4 V; 200 $\mu$ V
Voltage, 15 V range	-	-	0 to 15.3 V; 200 $\mu$ V
Voltage, 10 V range	-	-	0 to 10.2 V; 200 $\mu$ V
Voltage, 6 V range	0 to 6.12 V; 60 $\mu$ V	-6.12 V to 6.12 V; 60 $\mu$ V	0 to 6.12 V; 200 $\mu$ V
Voltage, 600 mV range	0 to 612 mV; 6 $\mu$ V	-612 mV to 612 mV; 6 $\mu$ V	-
Current, 8 A range	-	-	-8.16 A to 8.16 A; 75 $\mu$ A
Current, 6.7 A range	-	-	-6.83 A to 6.83 A; 75 $\mu$ A
Current, 5 A range	-	-	-5.1 A to 5.1 A; 75 $\mu$ A
Current, 4 A range	-	-	-4.08 A to 4.08 A; 75 $\mu$ A
Current, 3 A range	-3.06 A to 3.06 A; 25 $\mu$ A	-3.06 A to 3.06 A; 25 $\mu$ A	-
Current, 1 A range	-1.02 A to 1.02 A; 25 $\mu$ A	-1.02 A to 1.02 A; 25 $\mu$ A	-
Current, 300 mA range	-306 mA to 306 mA; 3 $\mu$ A	-	-
Current, 100 mA range	-	-102 mA to 102 mA; 1 $\mu$ A	-
Current, 10 mA range	-	-10.2 mA to 10.2 mA; 0.1 $\mu$ A	-
Resistance for 20 V range <sup>NOTE 1</sup>	-40m $\Omega$ to +1 $\Omega$ ; 0.5m $\Omega$	-	-40m $\Omega$ to +1 $\Omega$ ; 0.17m $\Omega$
Resistance for 15 V, & 10 V ranges <sup>NOTE 1</sup>	-	-	-40m $\Omega$ to +1 $\Omega$ ; 0.17m $\Omega$
Resistance for 6 V range <sup>NOTE 1</sup>	-40m $\Omega$ to +1 $\Omega$ ; 0.25m	-	-40m $\Omega$ to +1 $\Omega$ ; 0.17m $\Omega$
<b>Programming Accuracy Temperature Coefficient per <math>^{\circ}</math>C:</b>			
Voltage, 20 V range	0.002% +120uV	0.002% +120uV	0.0025% +200uV
Voltage, 10 V & 15 V ranges	-	-	0.0025% +200uV
Voltage, 6 V range	0.0015% +40uV	0.0015% +40uV	0.0025% +200uV
Voltage, 600 mV range	0.0015% +10uV	0.0015% +10uV	-
Current, 8 A, 6.7 A, 5 A, & 4 A ranges	-	-	0.0025% +150uA
Current, 3 A & 1 A ranges	0.0025% +22uA	0.0025% +22uA	-
Current, 300 mA range	0.0025% +14uA	-	-
Current, 100 mA range	-	0.0025% +1uA	-
Current, 10 mA range	-	0.0025% +0.5 $\mu$ A	-
<b>Measurement Resolution:</b>			
Voltage, 20 V range	200 $\mu$ V	200 $\mu$ V	200 $\mu$ V
Voltage, 1 V range	10 $\mu$ V	10 $\mu$ V	-
Voltage, 100 mV range	1 $\mu$ V	1 $\mu$ V	-
Auxiliary Voltage Measurement Input <sup>NOTE 1</sup>	800 $\mu$ V	-	800 $\mu$ V
<b>Measurement Resolution (continued)</b>			
Current, 8 A range	-	-	75 $\mu$ A
Current, 3 A range	25 $\mu$ A	25 $\mu$ A	-
Current, 100 mA range	1 $\mu$ A	1 $\mu$ A	1 $\mu$ A
Current, 1 mA range	10 nA	10 nA	10 nA
Current, 10 $\mu$ A range	0.1 nA	0.1 nA	-

## Supplemental Characteristics (continued)

	N6781A / N6782A	N6784A	N6785A / N6786A
<b>Measurement Accuracy Temperature Coefficient per °C:</b>			
Voltage, 20 V range	0.0025% +25 $\mu$ V	0.0025% +25 $\mu$ V	0.003% +75 $\mu$ V
Voltage, 1 V range	0.002% +2.5 $\mu$ V	0.002% +2.5 $\mu$ V	-
Voltage, 100 mV range	0.0025% +2.5 $\mu$ V	0.0025% +2.5 $\mu$ V	-
Auxiliary Voltage Measurement Input <sup>NOTE 1</sup>	0.0007% +200 $\mu$ V	-	0.0007% +200 $\mu$ V
Current, 8 A range	-	-	0.002% +110 $\mu$ A
Current, 3 A range	0.0025% +14 $\mu$ A	0.0025% +14 $\mu$ A	-
Current, 100 mA range	0.0025% +0.4 $\mu$ A	0.0025% +0.4 $\mu$ A	0.0025% +0.4 $\mu$ A
Current, 1 mA range	0.002% +5 nA	0.002% +5 nA	0.002% +5 nA
Current, 10 $\mu$ A range	0.002% +0.55 nA	0.002% +0.55 nA	-
<b>Voltage Programming Speed &amp; Settling Time: (At the specified bandwidth)</b>			
With slew rate set to maximum; with High 2 output cap = 1 $\mu$ F; with High 3 output cap = 7 $\mu$ F			
Compensation setting	Low High1 High 2 High 3	Low High1 High 2 High 3	Low High1 High2 High3
Rise Time from 10% to 90% of step			
20 V range with a 0-10 V step <sup>NOTE 2</sup>	300 $\mu$ s 15 $\mu$ s 20 $\mu$ s 120 $\mu$ s	300 $\mu$ s 15 $\mu$ s 20 $\mu$ s 120 $\mu$ s	300 $\mu$ s 12 $\mu$ s 15 $\mu$ s 40 $\mu$ s
15 V & 10 V ranges with a 0-4 V step	- - - -	- - - -	300 $\mu$ s 12 $\mu$ s 15 $\mu$ s 40 $\mu$ s
6 V range with a 0-4 V step	300 $\mu$ s 20 $\mu$ s 22 $\mu$ s 50 $\mu$ s	300 $\mu$ s 20 $\mu$ s 22 $\mu$ s 50 $\mu$ s	300 $\mu$ s 12 $\mu$ s 15 $\mu$ s 40 $\mu$ s
600 mV range with a 0-500 mV step	400 $\mu$ s 75 $\mu$ s 30 $\mu$ s 50 $\mu$ s	400 $\mu$ s 75 $\mu$ s 30 $\mu$ s 50 $\mu$ s	- - - -
Settling Time to 0.1% of step			
20 V range with a 0-10 V step <sup>NOTE 2</sup>	850 $\mu$ s 45 $\mu$ s 65 $\mu$ s 240 $\mu$ s	850 $\mu$ s 45 $\mu$ s 65 $\mu$ s 240 $\mu$ s	1.2ms 40 $\mu$ s 50 $\mu$ s 120 $\mu$ s
15 V, & 10 V ranges with a 0-4 V step	- - - -	- - - -	1.2ms 40 $\mu$ s 50 $\mu$ s 120 $\mu$ s
6 V range with a 0-4 V step	850 $\mu$ s 55 $\mu$ s 65 $\mu$ s 160 $\mu$ s	850 $\mu$ s 55 $\mu$ s 65 $\mu$ s 160 $\mu$ s	1.2ms 40 $\mu$ s 50 $\mu$ s 120 $\mu$ s
600 mV range with a 0-500 mV step	1.2 ms 220 $\mu$ s 85 $\mu$ s 170 $\mu$ s	1.2 ms 220 $\mu$ s 85 $\mu$ s 170 $\mu$ s	- - - -
<b>High Frequency Output Voltage Noise: (At the specified bandwidth)</b>			
With High 2 setting, output cap = 1 $\mu$ F; with High 3 setting, output cap = 7 $\mu$ F			
Compensation setting	Low High1 High 2 High 3	Low High1 High 2 High 3	Low High1 High2 High3
CV peak-to-peak from 20Hz - 20 MHz			
20 V range with any load	12 mV 12 mV 4 mV 4 mV	12 mV 12 mV 4 mV 4 mV	15mV 15mV 3 mV 3 mV
15 V & 10 V ranges with any load	- - - -	- - - -	15mV 15mV 3 mV 3 mV
6 V range with any load	12 mV 12 mV 4 mV 3 mV	12 mV 12 mV 4 mV 3 mV	15mV 15mV 3 mV 3 mV
600 mV range with any load	12 mV 12 mV 4 mV 3 mV	12 mV 12 mV 4 mV 3 mV	- - - -
CV rms from 20 Hz - 20 MHz			
20 V range with any load	1.2 mV 1.2 mV 0.5 mV 0.5 mV	1.2 mV 1.2 mV 0.5 mV 0.5 mV	1.5mV 1.5mV 0.4mV 0.3mV
15 V & 10 V ranges with any load	- - - -	- - - -	1.5mV 1.5mV 0.4mV 0.3mV
6 V range with any load	1 mV 1 mV 0.3 mV 0.3 mV	1 mV 1 mV 0.3 mV 0.3 mV	1.5mV 1.5mV 0.4mV 0.3mV
600 mV range with any load	1 mV 1 mV 0.3 mV 0.3 mV	1 mV 1 mV 0.3 mV 0.3 mV	- - - -
<b>Low Frequency Output Voltage Noise:</b>			
CV peak to peak from 0.1 Hz - 10 Hz			
20 V range	-	100 $\mu$ V	-
6 V range	-	50 $\mu$ V	-
600 mV range	-	20 $\mu$ V	-
CV rms from 0.1 Hz - 10 Hz			
20 V range	-	20 $\mu$ V	-
6 V range	-	10 $\mu$ V	-
600 mV range	-	5 $\mu$ V	-
<b>Voltage Programming Small Signal Bandwidth:</b>			
Refer to "Voltage Programming Response" later in this chapter.			

## Supplemental Characteristics (continued)

	N6781A / N6782A				N6784A				N6785A / N6786A			
<b>Voltage Measurement Noise:</b> (peak value)												
20 V range	3 mV				3 mV				2.9 mV			
1 V range	250 $\mu$ V				250 $\mu$ V				-			
100 mV range	50 $\mu$ V				50 $\mu$ V				-			
<b>Voltage Measurement Settling Time:</b> (All ranges)												
Settling Time with no range change	40 $\mu$ s				40 $\mu$ s				35 $\mu$ s			
<b>Voltage Measurement Small Signal Bandwidth:</b> (All ranges)												
-3 db typical with seamless ranging Off	DC to 30 kHz				DC to 30 kHz				DC to 30 kHz			
with seamless ranging On	DC to 27 kHz				-				-			
-1 db typical with seamless ranging Off	DC to 17 kHz				DC to 17 kHz				DC to 17 kHz			
with Seamless ranging On	DC to 15 kHz				-				-			
<b>Voltage Priority Transient Characteristic:</b> (Time to recover to within the settling band)												
At the specified bandwidth, 6 V range only, with remote sensing at load cap, 4.25' twisted pair load leads.												
Compensation setting	Low	High1	High2	High3	Low	High1	High2	High3	Low	High1	High2	High3
Settling band.	40 mV	50 mV	30 mV	20 mV	40 mV	50 mV	30 mV	20 mV	40 mV	50 mV	30 mV	20 mV
CC Load Step	0.2 A	0.2 A	0.5 A	1.4 A	0.2 A	0.2 A	0.5 A	1.4 A	0.2 A	0.2 A	0.5 A	1.4 A
Rise Time from 10% to 90% of step	10 $\mu$ s	5 $\mu$ s	5 $\mu$ s	10 $\mu$ s	10 $\mu$ s	5 $\mu$ s	5 $\mu$ s	10 $\mu$ s	10 $\mu$ s	5 $\mu$ s	5 $\mu$ s	10 $\mu$ s
Recovery time												
with no load cap	30 $\mu$ s	10 $\mu$ s	-	-	30 $\mu$ s	10 $\mu$ s	-	-	40 $\mu$ s	12 $\mu$ s	-	-
with 1 $\mu$ F load cap (ESR=50 m $\Omega$ )	-	20 $\mu$ s	10 $\mu$ s	-	-	20 $\mu$ s	10 $\mu$ s	-	-	20 $\mu$ s	12 $\mu$ s	-
with 6.8 $\mu$ F load cap (ESR=50 m $\Omega$ )	-	-	25 $\mu$ s	15 $\mu$ s	-	-	25 $\mu$ s	15 $\mu$ s	-	-	14 $\mu$ s	15 $\mu$ s
with 150 $\mu$ F load cap (ESR=50 m $\Omega$ )	140 $\mu$ s	-	-	35 $\mu$ s	140 $\mu$ s	-	-	35 $\mu$ s	150 $\mu$ s	-	-	25 $\mu$ s
Maximum peak voltage deviation												
with no load cap	180 mV	200 mV	-	-	180 mV	200 mV	-	-	250mV	260mV	-	-
with 1 $\mu$ F load cap (ESR=50 m $\Omega$ )	-	260 mV	140 mV	-	-	260 mV	140 mV	-	-	290mV	140mV	-
with 6.8 $\mu$ F load cap (ESR=50 m $\Omega$ )	-	-	140 mV	60 mV	-	-	140 mV	60 mV	-	-	140mV	60 mV
with 150 $\mu$ F load cap (ESR=50 m $\Omega$ )	45 mV	-	-	45 mV	45 mV	-	-	45 mV	65 mV	-	-	45 mV
<b>Auxiliary Voltage Measurement Input:</b> <sup>NOTE 1</sup>												
Differential input resistance	10 M $\Omega$				-				10 M $\Omega$			
Maximum conversion rate	100k samples/second				-				100k samples/second			
Maximum voltage from common	$\pm$ 240 VDC				-				$\pm$ 240 VDC			
Maximum continuous input without damage	$\pm$ 60 V				-				$\pm$ 60 V			
<b>Over-Voltage Protection:</b>												
Accuracy	0.05% + 20 mV				0.05% + 20 mV				0.05% + 20 mV			
Maximum setting	24 V				24 V				24 V			
Response time <sup>NOTE 3</sup>	<30 $\mu$ s				<30 $\mu$ s				<30 $\mu$ s			
Programmable delay range & default value	30 to 272 $\mu$ s; 30 $\mu$ s				30 to 272 $\mu$ s; 30 $\mu$ s				30 to 272 $\mu$ s; 30 $\mu$ s			
<b>Source Effect (Line regulation):</b>												
Voltage, all ranges	300 $\mu$ V				300 $\mu$ V				100 $\mu$ V			
Current, all ranges	60 $\mu$ A				60 $\mu$ A				100 $\mu$ A			
<b>Current Programming Speed &amp; Settling Time:</b>												
Rise Time from 10% to 90% of step												
8 A range with a 0-8 A step	-				-				3.0 $\mu$ s			
3 A range with a 0-3 A step	2.8 $\mu$ s				2.8 $\mu$ s				-			
1 A range with a 0-1 A step	3.2 $\mu$ s				3.2 $\mu$ s				-			
300 mA range with a 0-300 mA step	3.5 $\mu$ s				-				-			
100 mA range with a 0-100 mA step	-				4 $\mu$ s				-			
10 mA range with a 0-10 mA step	-				5 $\mu$ s				-			

## Supplemental Characteristics (continued)

	N6781A / N6782A	N6784A	N6785A / N6786A
<b>Current Programming Speed &amp; Settling Time (continued)</b>			
Settling Time to 0.1% of step			
8 A range with a 0-8 A step	-	-	20 $\mu$ s
3 A range with a 0-3 A step	30 $\mu$ s	30 $\mu$ s	-
1 A range with a 0-1 A step	30 $\mu$ s	30 $\mu$ s	-
300 mA range with a 0-300 mA step	40 $\mu$ s	-	-
100 mA range with a 0-100 mA step	-	30 $\mu$ s	-
10 mA range with a 0-10 mA step	-	30 $\mu$ s	-
<b>High Frequency Output Current Noise: (All ranges)</b>			
CC rms from 20 Hz – 20 MHz	200 $\mu$ A	200 $\mu$ A	1 mA
<b>Low Frequency Output Current Noise: (CC rms from 0.1 Hz – 10 Hz)</b>			
3 A & 1 A ranges	-	2 $\mu$ A	-
100 mA range	-	50 nA	-
10 mA range	-	20 nA	-
<b>Current Programming Small Signal Bandwidth:</b>			
-3 dB all except 100 mA & 10 mA range	DC to 120 kHz	DC to 120 kHz	DC to 130 kHz
for 100 mA & 10 mA range	-	DC to 100 kHz	-
-1 dB all except 100 mA & 10 mA range	DC to 75 kHz	DC to 75 kHz	DC to 70 kHz
for 100 mA & 10 mA range	-	DC to 50 kHz	-
<b>Current Measurement Noise: (Peak value)</b>			
8 A range	-	-	1.2 mA
3 A range	400 $\mu$ A	400 $\mu$ A	-
100 mA range	20 $\mu$ A	20 $\mu$ A	13.5 $\mu$ A
1 mA range	2 $\mu$ A	2 $\mu$ A	1.4 $\mu$ A
10 $\mu$ A range	20 nA	20 nA	-
<b>Current Measurement Settling Time: (to 1% of the specified step with no range change or with up-ranging)</b>			
8 A range with 0.5-1A step	-	-	35 $\mu$ s
3 A range with a 0.5-1 A step	35 $\mu$ s	35 $\mu$ s	-
100 mA range with a 50-100 mA step	35 $\mu$ s	35 $\mu$ s	35 $\mu$ s
1 mA range with a 0.5-1 mA step	120 $\mu$ s	120 $\mu$ s	120 $\mu$ s
10 $\mu$ A range with a 5-10 $\mu$ A step	750 $\mu$ s	750 $\mu$ s	-
Up-ranging to			
8 A range with a 0-8 A step	-	-	35 $\mu$ s
3 A range with a 0-3 A step	35 $\mu$ s	-	-
100 mA range with a 0-100 mA step	35 $\mu$ s	-	35 $\mu$ s
1 mA range with a 0-1 mA step	120 $\mu$ s	-	-
(to 1% of the specified range with down-ranging)			
Down-ranging from 3 A & 8 A ranges to:			
100 mA range	45 $\mu$ s	45 $\mu$ s	50 $\mu$ s
1 mA range	200 $\mu$ s	200 $\mu$ s	200 $\mu$ s
10 $\mu$ A range	3.5 ms	3.5 ms	-
<b>Current Measurement Small Signal Bandwidth:</b>			
-3 dB typical with seamless ranging Off			
8 A range	-	-	DC to 28 kHz
3 A range	DC to 29 kHz	DC to 27 kHz	-
100 mA range	DC to 29 kHz	DC to 27 kHz	DC to 30 kHz
1 mA range	DC to 10 kHz	DC to 10 kHz	DC to 10 kHz
10 $\mu$ A range	DC to 750 Hz	DC to 750 Hz	-

## Supplemental Characteristics (continued)

	N6781A / N6782A	N6784A	N6785A / N6786A
<b>Current Measurement Small Signal Bandwidth (continued)</b>			
-3 dB typical with seamless ranging On			
8 A range	-	-	DC to 26 kHz
3 A range	DC to 26 kHz	-	-
100 mA range	DC to 26 kHz	-	DC to 27 kHz
1 mA range	DC to 10 kHz	-	DC to 10 kHz
-1 dB typical with seamless ranging Off			
8 A range	-	-	DC to 16 kHz
3 A range	DC to 16 kHz	DC to 16 kHz	-
100 mA range	DC to 16 kHz	DC to 16 kHz	DC to 17 kHz
1 mA range	DC to 6 kHz	DC to 6.5 kHz	DC to 6 kHz
10 µA range	DC to 400 Hz	DC to 400 Hz	-
-1 dB typical with seamless ranging On			
8 A range	-	-	DC to 15 kHz
3 A range	DC to 14 kHz	-	-
100 mA range	DC to 14 kHz	-	DC to 15 kHz
1 mA range	DC to 6 kHz	-	DC to 16 kHz
<b>Current Priority Transient Characteristic: (with 4.25' twisted pair load leads)</b>			
8 A range with a 5-15 V step			
Current settling band	-	-	40 mA
Recovery time	-	-	5 µs
3 A range with a 1-4 V step			
Current settling band	5 mA	5 mA	-
Recovery time	12 µs	12 µs	-
1 A range with a 0.5-0 V step			
Current settling band	10 mA	10 mA	-
Recovery time	12 µs	12 µs	-
<b>Common Mode Current from 20 Hz – 20 MHz: (with negative output connected to chassis)</b>			
CC peak-to-peak	< 1 mA	< 1 mA	< 1.5 mA
CC rms	< 100 µA	< 100 µA	< 150 µA
<b>Remote Sense Capability:</b>	Outputs can maintain specifications with up to a 1-volt drop per load lead. The load lead drop reduces the maximum available voltage at the load.		
<b>Parallel Operation:</b> <sup>NOTE 4</sup>	Identically rated outputs can be operated directly in parallel in Current Priority mode only. Operating units in series is not available.		
<b>Minimum Output Turn-on Delay:</b> (Time from when any Output On command is received until the output starts turning on.)			
Turn-off mode set to Low impedance	25.6 ms	25.6 ms	25.6 ms
Turn-off mode set to High impedance	24.7 ms	24.7 ms	24.7 ms

<sup>1</sup> Applies to N6781A and N6785A only

<sup>2</sup> For N6785A and N6786A applies with a 0 - 4 V step.

<sup>3</sup> Response time applies from the occurrence of the over-voltage condition to the start of output shutdown.

<sup>4</sup> In CV priority mode, uneven current sharing while paralleling prevents using the lower current measurement ranges and will also cause degradation in transient response performance.

# Output Quadrant Characteristic

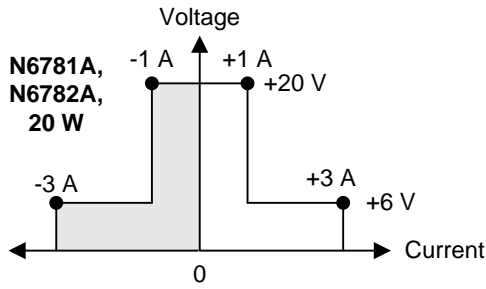

Key  
 □ Sourcing power  
 ■ Sinking power

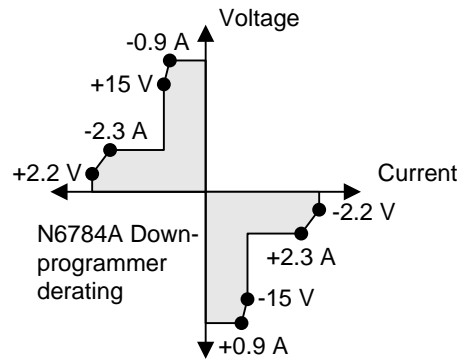
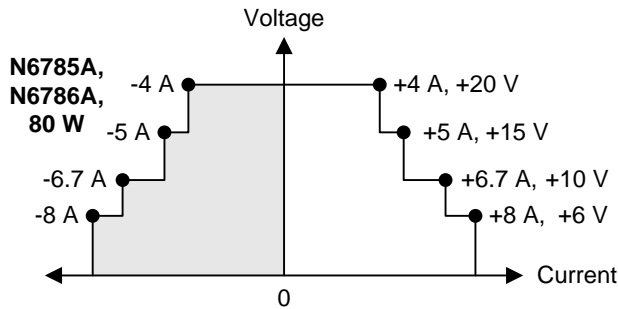
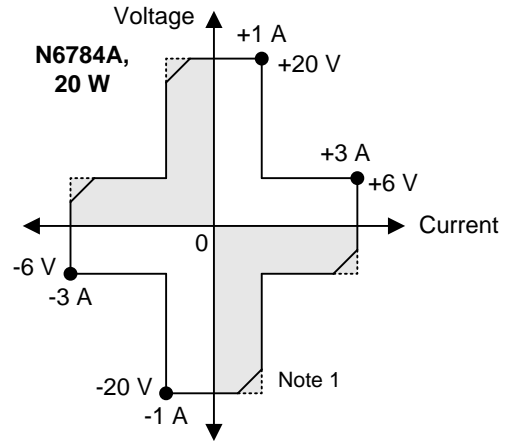

Note 1. When sinking power, Keysight Model N6784A can operate at the maximum rated output power for only a limited time. When the internal temperature of the unit exceeds its safe limit, the output latches off. A protect clear is required to resume normal operation. The condition is annunciated by the OT status bit. The Downprogrammer derating figure shows the safe limit boundary values.

# Output Impedance Graphs

N6781A  
 N6782A  
 N6784A  
 CV Mode  
 @3V, 0.5A

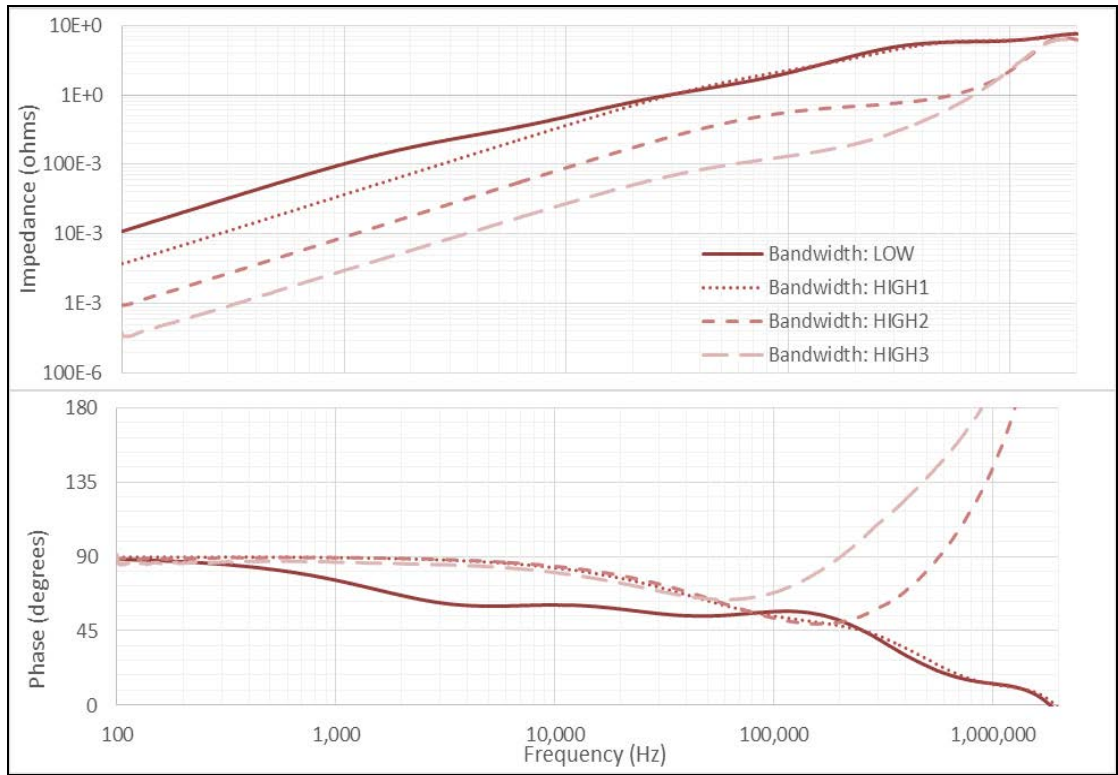

N6781A  
 N6782A  
 N6784A  
 CC Mode  
 @2.4V,  
 0.4A

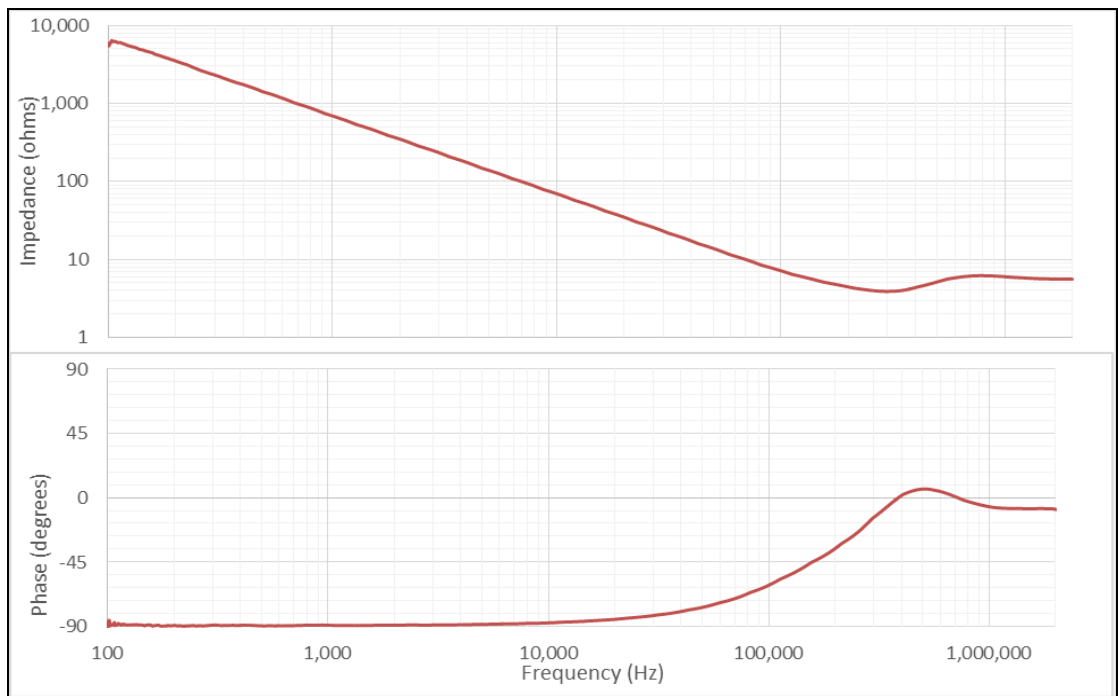



N6785A  
 N6786A  
 CV Mode  
 @3V, 0.5A

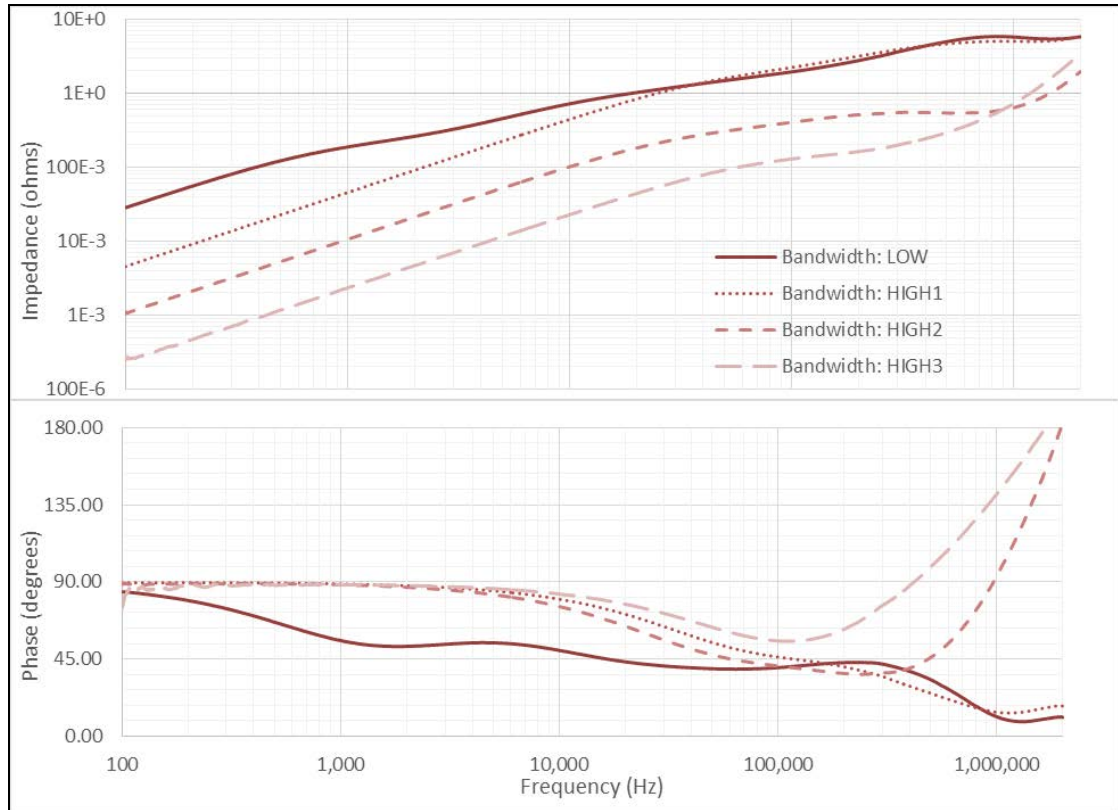

N6785A  
 N6786A  
 CC Mode  
 @2.4V,  
 0.4A

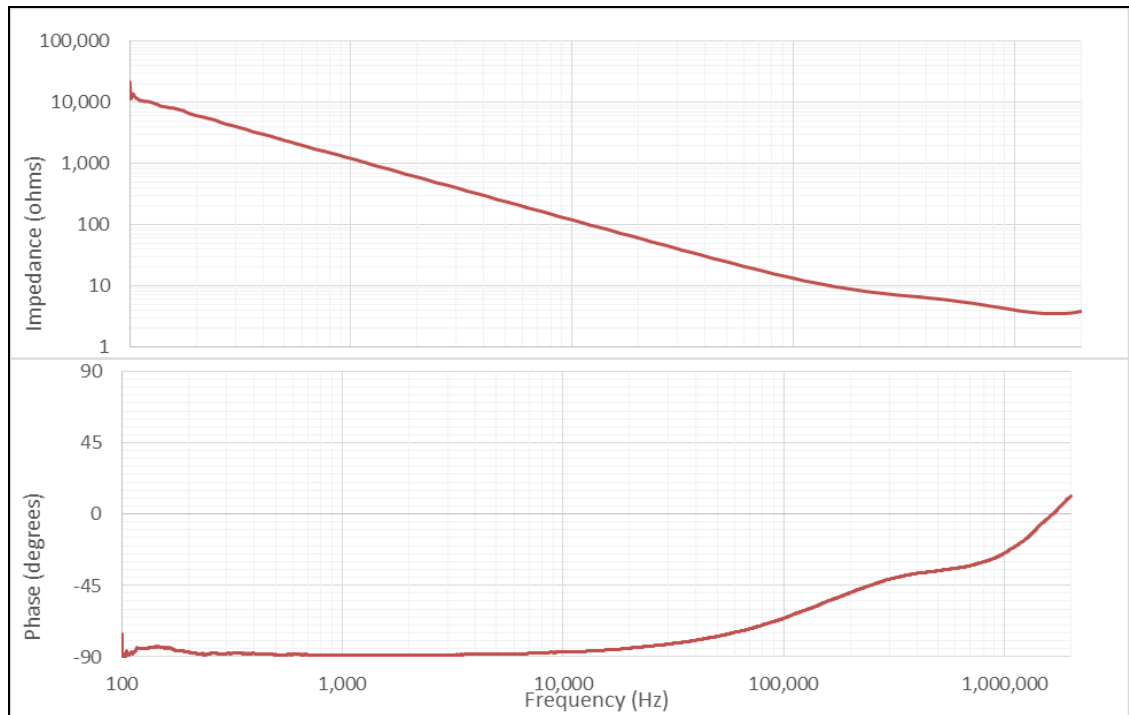

# Voltage Programming Response

The following graphs show the voltage programming response with the indicated bandwidths and loads. Note that the load ESR=200 mΩ.

N6781A  
 N6782A  
 N6784A  
 Bandwidth  
 LOW  
 HIGH 1

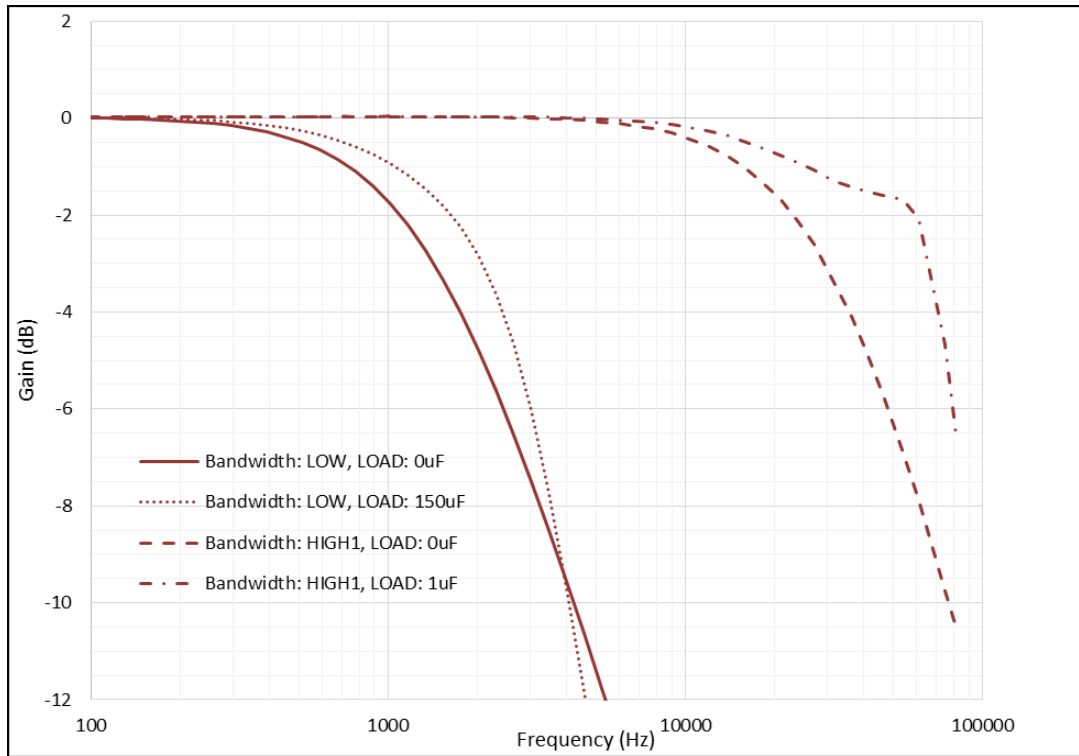

N6781A  
 N6782A  
 N6784A  
 Bandwidth  
 HIGH 2  
 HIGH 3

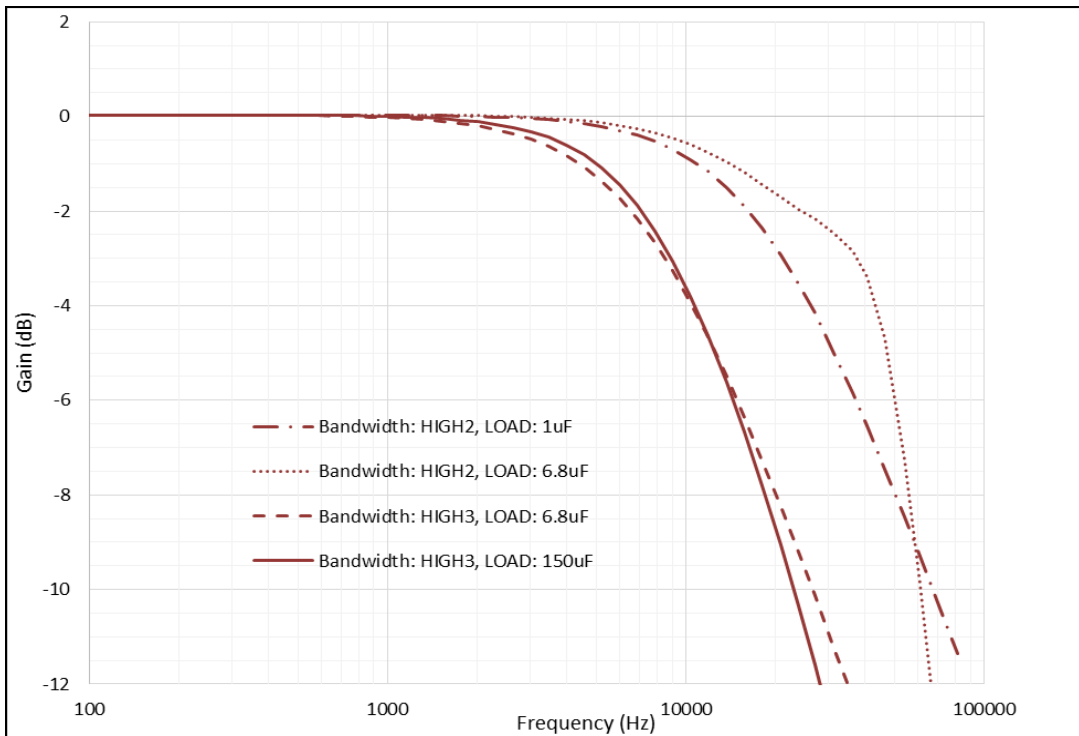

N6785A  
 N6786A  
 Bandwidth  
 LOW  
 HIGH 1

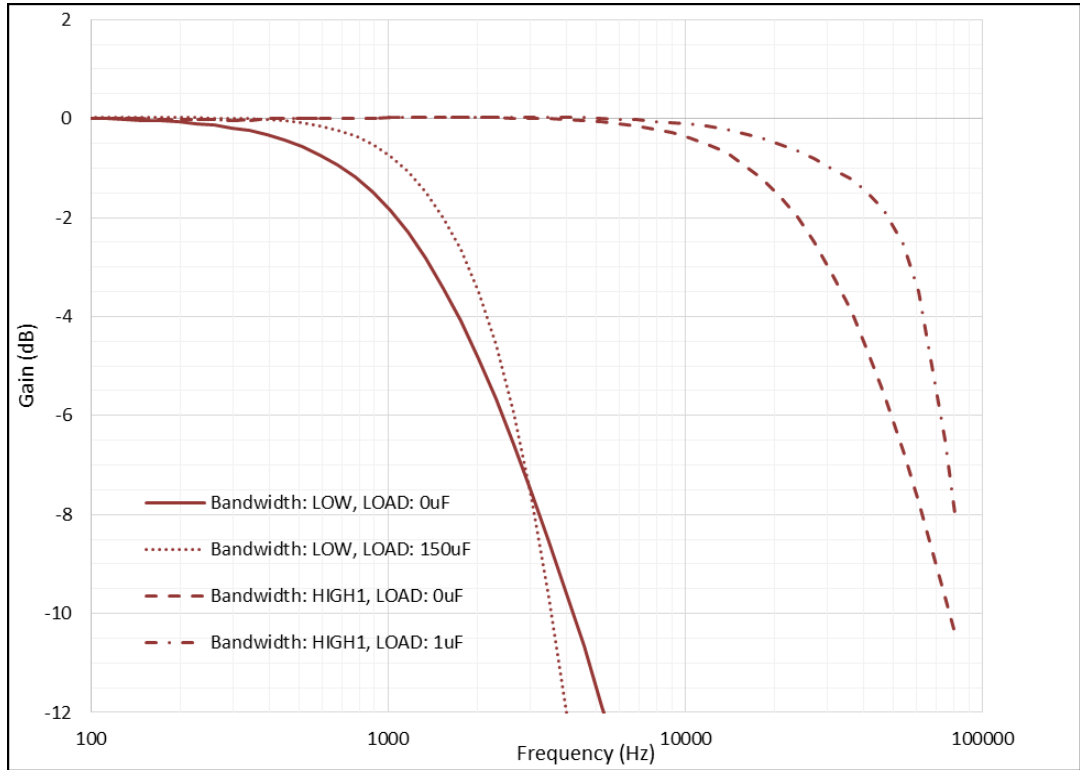

N6785A  
 N6786A  
 Bandwidth  
 HIGH 2  
 HIGH 3

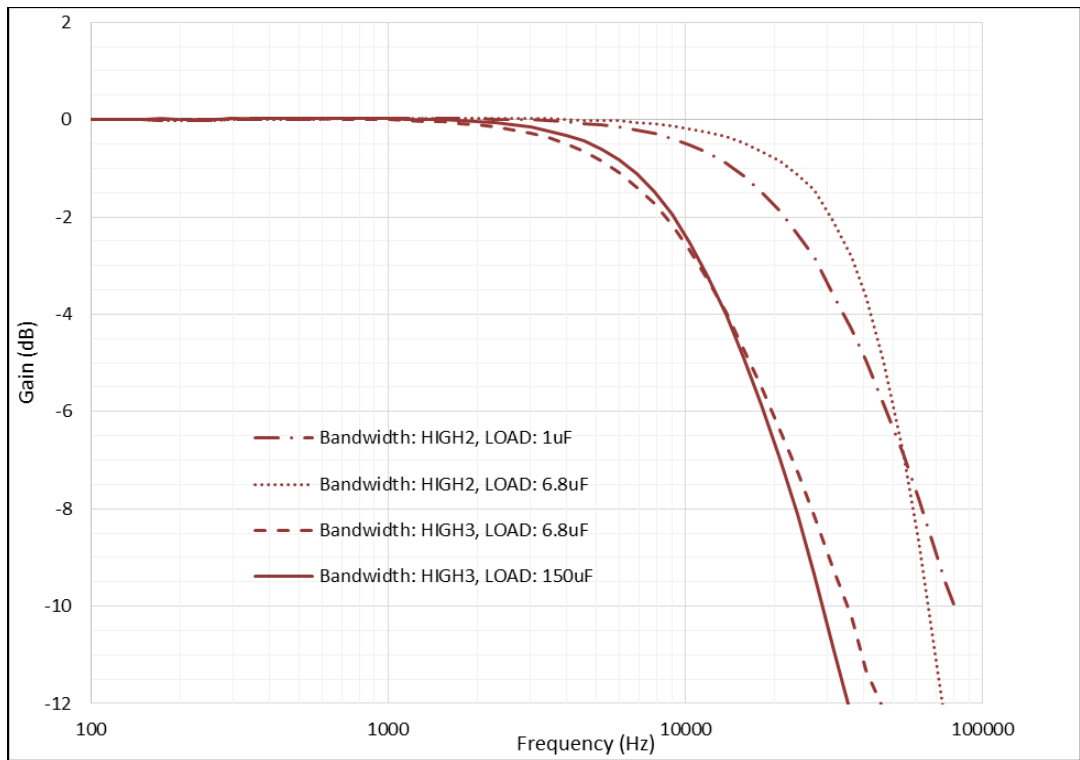

## Measurement Accuracy and Resolution (with shorter measurement intervals)

The following table shows changes to the short-term measurement accuracy and resolution with various number of power line cycle (NPLC) measurement settings. Changes are due to the A-to-D converter's noise performance. The table's baseline is 1 NPLC with no added noise. To determine the measurement accuracy at shorter averaging intervals, simply add the noise value to the fixed accuracy value in the specification table.

### N6785A and N6786A

<b>NPLC @ 60 Hz:</b>	0.0003	0.003	0.006	0.010	0.031	0.06	0.1	0.6	1
<b>Time:</b>	5.1E-6	51.2E-6	102.4E-6	169E-6	512E-6	998.4E-6	1.7E-3	10E-3	16.7E-3
<b>Averaged points:</b>	1	10	20	33	100	195	325	1953	3255
<b>20V range noise:</b>	2.9E-3	1.3E-3	1.0E-3	1.0E-3	394.2E-6	298.5E-6	260.6E-6	98.1E-6	69.8E-6
<b>Resolution (bits):</b>	12.7	13.9	14.2	14.2	15.6	16	16.2	17.6	18.1
<b>8A range noise:</b>	1.2E-3	552.2E-6	409.7E-6	313.8E-6	198.9E-6	138.0E-6	94.4E-6	45.6E-6	43.5E-6
<b>Resolution (bits):</b>	12.7	13.8	14.2	14.6	15.2	15.8	16.3	17.4	17.4
<b>100mA range noise:</b>	13.5E-6	7.1E-6	5.4E-6	4.1E-6	2.5E-6	1.7E-6	1.3E-6	644.2E-9	471.5E-9
<b>Resolution (bits):</b>	12.8	13.7	14.1	14.5	15.2	15.8	16.2	17.2	17.6
<b>1mA range noise:</b>	1.4E-6	594.3E-9	306.2E-9	191.0E-9	67.7E-9	38.8E-9	23.8E-9	8.2E-9	6.9E-9
<b>Resolution (bits):</b>	9.4	10.7	11.6	12.3	13.8	14.6	15.3	16.8	17.1

### N6781A, N6782A and N6784A

<b>NPLC @ 60 Hz:</b>	0.0003	0.003	0.006	0.010	0.031	0.06	0.1	0.6	1
<b>Time:</b>	5.1E-6	51.2E-6	102.4E-6	169E-6	512E-6	998.4E-6	1.7E-3	10E-3	16.7E-3
<b>Averaged points:</b>	1	10	20	33	100	195	325	1953	3255
<b>20V range noise:</b>	2.3E-3	1.2E-3	993.7E-6	894.8E-6	533.4E-6	297.5E-6	276.6E-6	87.4E-6	69.6E-6
<b>Resolution (bits):</b>	13	14	14.2	14.4	15.1	16	16.1	17.7	18.1
<b>1V range noise:</b>	186.6E-6	90.3E-6	57.0E-6	45.5E-6	26.7E-6	22.1E-6	19.8E-6	7.1E-6	4.8E-6
<b>Resolution (bits):</b>	12.3	13.4	14	14.4	15.1	15.4	15.6	17.1	17.6
<b>100mV range noise:</b>	38.9E-6	20.7E-6	12.5E-6	10.5E-6	5.9E-6	5.1E-6	5.0E-6	3.9E-6	3.4E-6
<b>Resolution (bits):</b>	11.3	12.2	12.9	13.2	14	14.2	14.2	14.6	14.8
<b>3A range noise:</b>	480.3E-6	206.4E-6	159.7E-6	120.5E-6	71.0E-6	48.3E-6	41.4E-6	16.8E-6	18.5E-6
<b>Resolution (bits):</b>	12.6	13.8	14.2	14.6	15.3	15.9	16.1	17.4	17.2
<b>100mA range noise:</b>	14.1E-6	8.7E-6	6.4E-6	4.4E-6	2.5E-6	2.2E-6	1.5E-6	858.1E-9	573.3E-9
<b>Resolution (bits):</b>	12.8	13.4	13.9	14.4	15.2	15.4	16	16.8	17.4
<b>1mA range noise:</b>	1.8E-6	798.7E-9	363.1E-9	248.5E-9	74.1E-9	44.8E-9	27.3E-9	8.5E-9	6.8E-9
<b>Resolution (bits):</b>	9.1	10.2	11.4	11.9	13.7	14.4	15.1	16.8	17.1
<b>10UA range noise:</b>	15.9E-9	18.0E-9	20.3E-9	15.4E-9	11.0E-9	4.8E-9	3.3E-9	752.2E-12	456.3E-12
<b>Resolution (bits):</b>	9.2	9.1	8.9	9.3	9.8	11	11.5	13.7	14.4

# Chapter 6

## Keysight N6783A-BAT, N6783A-MFG Application-Specific Power Modules

Performance Specifications.....	54
Supplemental Characteristics .....	55
Output Quadrant Characteristic .....	56

Unless otherwise noted, specifications are warranted over the ambient temperature range of 0 to 40°C after a 30-minute warm-up period. Unless otherwise noted, accuracy is specified as percent of value + fixed offset.

Specifications apply at the output terminals, with each module's sense terminals internally connected to its output terminals (local sensing).

Refer to the Keysight N6700 or N6705 Service Guide for the setup conditions for all performance specifications.

Supplemental characteristics are not warranted but are descriptions of performance determined either by design or by type testing. All supplemental characteristics are typical unless otherwise noted.

# Performance Specifications

	N6783A-BAT	N6783A-MFG
<b>DC Ratings:</b>		
Voltage	0 - 8 V	0 - 6 V
Current <sup>NOTE 1</sup>	- 2 to +3 A	- 2; 0 to +3 A
Power	24 W	18 W
Low current measurement range	150 mA	150 mA
<b>Output Ripple and Noise (PARD):</b> (from 20 Hz - 20 MHz)		
CV peak-to-peak	8 mV	8 mV
CV rms	1.5 mV	1.5 mV
<b>Load Effect (Regulation):</b> (For any output load change, with a maximum load-lead drop of 0.5V/lead. The load lead drop reduces the maximum available voltage at the load.)		
Voltage	6 mV	6 mV
Current	2 mA	2 mA
<b>Source Effect (Regulation):</b>		
Voltage	2 mV	2 mV
Current	1 mA	1 mA
<b>Programming Accuracy:</b> (@ 23 °C ±5 °C after a 30 minute warm-up. Applies from minimum to maximum programming range at any load.)		
Voltage	0.1% + 10 mV	0.1% + 10 mV
Positive Current	0.1% + 1.8 mA	0.1% + 1.8 mA
Negative Current @ -2 A	0.2% + 1.8 mA	N/A
<b>Measurement Accuracy:</b> (@ 23 °C ±5 °C. Applies when measuring the default value of 1024 data points with a 20.48 μs time interval.)		
Voltage	0.05% + 5 mV	0.05% + 5 mV
Current high range	0.1% + 600 μA	0.1% + 600 μA
Current low range	0.1% + 75 μA	0.1% + 75 μA
<b>Load Transient Recovery:</b> (Time to recover to within settling band for a load change from 0.15 A to 1.5 A and from 1.5 A to 0.15 A at 6 V output)		
Settling band <sup>NOTE 2</sup>	± 75 mV	± 75 mV
Time <sup>NOTE 2</sup>	< 45 μs	< 45 μs

<sup>1</sup> Output current is derated 1% per °C above 40°C.

<sup>2</sup> When relay Option 761 is installed, the settling band is ± 90 mV. The time is < 75 μs.

## Supplemental Characteristics

	N6783A-BAT	N6783A-MFG
<b>Programming Ranges:</b>		
Voltage	15 mV – 8.16 V	15 mV – 6.12 V
Positive Current	5 mA – 3.06 A	5 mA – 3.06 A
Negative Current	– 5 mA to – 2 A	Fixed at – 2 A
<b>Programming Resolution:</b>		
Voltage	2.5 mV	2.5 mV
Positive Current	1 mA	1 mA
Negative Current	10 mA	N/A
<b>Measurement Resolution:</b>		
Voltage	300 $\mu$ V	300 $\mu$ V
Current high range	100 $\mu$ A	100 $\mu$ A
Current low range ( $\leq 0.150$ A)	5 $\mu$ A	5 $\mu$ A
<b>Programming Temperature Coefficient per <math>^{\circ}</math>C:</b>		
Voltage	25 ppm + 50 $\mu$ V	25 ppm + 50 $\mu$ V
Current	25 ppm + 10 $\mu$ A	25 ppm + 10 $\mu$ A
<b>Measurement Temperature Coefficient per <math>^{\circ}</math>C:</b>		
Voltage	25 ppm + 40 $\mu$ V	25 ppm + 40 $\mu$ V
Current high range	25 ppm + 2.5 $\mu$ A	25 ppm + 2.5 $\mu$ A
Current low range ( $\leq 0.150$ A)	25 ppm + 1.5 $\mu$ A	25 ppm + 1.5 $\mu$ A
<b>Maximum Up-Programming and Down-Programming Time with Full Resistive Load:</b> (Time from 10% to 90% of total voltage excursion)		
Voltage Settling from 0V to Full Scale	4.0 ms	4.0 ms
Voltage Settling from Full Scale to 0V	4.0 ms	4.0 ms
<b>Maximum Up-Programming and Down-Programming Settling Time with Full Resistive Load:</b> (Time from start of voltage change until voltage settles within 0.1% of the full-scale voltage of its final value)		
Voltage Settling from 0V to Full Scale	20 ms	20 ms
Voltage Settling from Full Scale to 0V	20 ms	20 ms
<b>Over-voltage Protection:</b>		
Accuracy without disconnect relays	0.25% + 75 mV	0.25% + 75 mV
Accuracy with disconnect relays	0.25% + 275 mV	0.25% + 275 mV
Nominal range	0 – 10 V	0 – 10 V
Programmable delay time	60 $\mu$ s – 5 ms	60 $\mu$ s – 5 ms
<b>Output Ripple and Noise: (PARD)</b>		
CC rms:	4 mA	4 mA
<b>Common Mode Noise:</b> (From 20 Hz – 20 MHz; from either output to chassis)		
Rms	1 mA	1 mA
Peak-to-peak	6 mA	6 mA
<b>Remote Sense Capability:</b>		
Outputs can maintain DC specifications with up to a 0.5-volt drop per load lead. Maximum sense lead resistance is limited to 300m $\Omega$ /lead.		

## Supplemental Characteristics (continued)

	N6783A-BAT	N6783A-MFG
<b>Series and Parallel Operation:</b>	Identically rated outputs <b>can</b> be operated directly in parallel. N6783A modules <b>cannot</b> be used in series with other N6783A modules or any other N67xx module.	
<b>Down-programming Capability:</b> (Current down-programming capability is reduced at output voltages below 0.5 V)		
Continuous power	12 W	12 W
Continuous current	2 A	2 A

### Output Quadrant Characteristic

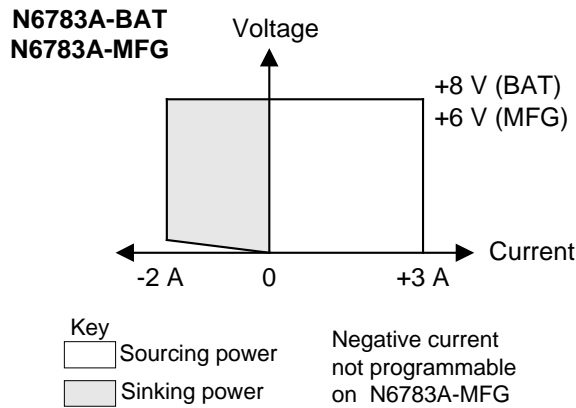



# Chapter 7

## Keysight N6791A, N6792A

### Electronic Load Modules

Performance Specifications.....	58
Supplemental Characteristics .....	58
Output Quadrant Characteristic .....	60

Unless otherwise noted, specifications are warranted over the ambient temperature range of 0 to 40°C after a 30-minute warm-up period. Unless otherwise noted, accuracy is specified as percent of value + fixed offset.

Specifications apply at the output terminals, with each module's sense terminals internally connected to its output terminals (local sensing).

Refer to the Keysight N6700 or N6705 Service Guide for the setup conditions for all performance specifications.

Supplemental characteristics are not warranted but are descriptions of performance determined either by design or by type testing. All supplemental characteristics are typical unless otherwise noted.

# Performance Specifications

	N6791A	N6792A	
<b>Input Ratings:</b>			
Current	0 - 20 A	0 - 40 A	
Voltage	0 - 60 V	0 - 60 V	
Maximum Power @ 40 °C <sup>NOTE 1</sup>	100 W	200 W	
<b>Specified Current @ Low Voltage Operation:</b> (see Output Quadrant Characteristic)			
1.6 V	20 A	40 A	
1 V	12.5 A	25 A	
0.5 V	6.25 A	12.5 A	
0.1 V	1.25 A	2.5 A	
<b>Programming Accuracy:</b> (@ 25 °C ±5 °C after a 30 minute warm-up. Applies from minimum to maximum programming range at any load.)			
Current high range	20 A/40 A	0.04 % + 2.6 mA	0.04 % + 5.2 mA
Current low range	2 A/4 A	0.04 % + 0.46 mA	0.04 % + 0.92 mA
Voltage	60 V	0.03 % + 7.2 mV	0.03 % + 7.2 mV
Resistance high range <sup>NOTE 2</sup>	8 kΩ	± (0.1 % + 0.0014) S	± (0.1 % + 0.0028) S
Resistance medium range <sup>NOTE 2</sup>	100 Ω	± (0.1 % + 0.014) S	± (0.1 % + 0.019) S
Resistance low range <sup>NOTE 2</sup>	3 Ω	± (0.1 % + 0.38) S	± (0.1 % + 0.55) S
Power high range	100 W/200 W	0.06 % + 180 mW	0.06 % + 360 mW
Power low range	10 W/20 W	0.06 % + 30 mW	0.06 % + 65 mW
<b>Measurement Accuracy:</b> (@ 25 °C ±5 °C. Applies when measuring the default value of 1024 data points with a 20.48 μs time interval.)			
Current high range	20 A/40 A	0.04 % + 2.4 mA	0.04 % + 4.6 mA
Current low range	2 A/4 A	0.04 % + 0.40 mA	0.04 % + 0.82 mA
Voltage	60 V	0.03 % + 7.2 mV	0.03 % + 7.2 mV
Power high range	100 W/200 W	0.06 % + 160 mW	0.06 % + 320 mW
Power low range	10 W/20 W	0.06 % + 25 mW	0.06 % + 50 mW

<sup>1</sup> Maximum continuous power is derated linearly from 100% of maximum @ 40 °C to 75% of maximum @ 55 °C.

<sup>2</sup> Based on minimum operating resistance, 0.08 Ω for 100W and 0.04 Ω for 200W. This means that below 1.6 V, the rated current decreases linearly based on the rate of the respective minimum operating resistance.

## Supplemental Characteristics

	N6791A	N6792A
<b>Programming Ranges &amp; Resolution:</b>		
Current high range	5 mA – 20.4 A; 250 $\mu$ A	10 mA – 40.8 A; 500 $\mu$ A
Current low range	1 mA – 2.04 A; 25 $\mu$ A	2 mA – 4.08 A; 50 $\mu$ A
Voltage:	10 mV – 61.2 V; 1.5 mV	10 mV – 61.2 V; 1.5 mV
Resistance high range	30 $\Omega$ – 8 k $\Omega$ ; 25 $\mu$ S	15 $\Omega$ – 8 k $\Omega$ ; 50 $\mu$ S
Resistance medium range	2 $\Omega$ – 100 $\Omega$ ; 250 $\mu$ S	2 $\Omega$ – 100 $\Omega$ ; 500 $\mu$ S
Resistance low range	80 m $\Omega$ – 3 $\Omega$ ; 250 $\mu$ S	40 m $\Omega$ – 3 $\Omega$ ; 500 $\mu$ S
Power high range	0.3 W – 102 W; 15 mW	0.5 W – 204 W; 30 mW
Power low range	0.04 W–10.2 W; 1.5 mW	0.1 W – 20.4 W; 3 mW
<b>Minimum Compliance Settings:</b>		
Current high range	5 mA	10 mA
Current low range	1 mA	2 mA
Voltage range	10 mV	10 mV
Resistance high range	Fixed at 2 A	Fixed at 4 A
Resistance medium range	Fixed at 20 A	Fixed at 40 A
Resistance low range	Fixed at 20 A	Fixed at 40 A
Power high range	0.3 W	0.5 W
Power low range	0.04 W	0.1 W
<b>Measurement Resolution:</b>		
Current high range	0.4 mA	0.8 mA
Current low range	0.12 mA	0.16 mA
Voltage range	1 mV	1 mV
<b>Programming and Measurement Temperature Coefficient per <math>^{\circ}</math>C:</b>		
Current high range	0.008%/ $^{\circ}$ C + 300 $\mu$ A/ $^{\circ}$ C	0.008%/ $^{\circ}$ C + 500 $\mu$ A/ $^{\circ}$ C
Current low range	0.009%/ $^{\circ}$ C + 50 $\mu$ A/ $^{\circ}$ C	0.008%/ $^{\circ}$ C + 90 $\mu$ A/ $^{\circ}$ C
Voltage	0.005%/ $^{\circ}$ C + 1 mV/ $^{\circ}$ C	0.005%/ $^{\circ}$ C + 1 mV/ $^{\circ}$ C
Resistance high range	programming only 0.01%/ $^{\circ}$ C + 100 $\mu$ S/ $^{\circ}$ C	0.01%/ $^{\circ}$ C + 160 $\mu$ S/ $^{\circ}$ C
Resistance medium range	programming only 0.01%/ $^{\circ}$ C + 0.8 mS/ $^{\circ}$ C	0.01%/ $^{\circ}$ C + 1 mS/ $^{\circ}$ C
Resistance low range	programming only 0.01%/ $^{\circ}$ C + 12 mS/ $^{\circ}$ C	0.01%/ $^{\circ}$ C + 23 mS/ $^{\circ}$ C
Power high range	0.015%/ $^{\circ}$ C + 20 mW/ $^{\circ}$ C	0.015%/ $^{\circ}$ C + 30 mW/ $^{\circ}$ C
Power low range	0.015%/ $^{\circ}$ C + 3 mW/ $^{\circ}$ C	0.015%/ $^{\circ}$ C + 5 mW/ $^{\circ}$ C
<b>Programmable Slew Rates:</b>		
Current high range:	100 A/s – 2.4 MA/s	100 A/s – 5 MA/s
Current low range:	10 A/s – 220 kA/s	10 A/s – 500 kA/s
Voltage:	> 6 V 100 V/s – 280 kV/s $\leq$ 6 V 100 V/s – 28 kV/s	100 V/s – 280 kV/s 100 V/s – 28 kV/s
Resistance high range	Up-programming Down programming 1 k $\Omega$ /s – 2.5 M $\Omega$ /s 1 k $\Omega$ /s – 25 M $\Omega$ /s	1 k $\Omega$ /s – 2.5 M $\Omega$ /s 1 k $\Omega$ /s – 25 M $\Omega$ /s
Resistance medium range	Up-programming Down programming 100 $\Omega$ /s – 200 k $\Omega$ /s 10 $\Omega$ /s – 2 M $\Omega$ /s	100 $\Omega$ /s – 200 k $\Omega$ /s 10 $\Omega$ /s – 2 M $\Omega$ /s
Resistance low range	Up-programming Down programming 10 $\Omega$ /s – 5 k $\Omega$ /s 10 $\Omega$ /s – 60 k $\Omega$ /s	10 $\Omega$ /s – 6 k $\Omega$ /s 10 $\Omega$ /s – 120 k $\Omega$ /s
Power high range	10 W/s – 240 kW/s	10 W/s – 480 kW/s
Power low range	1 W/s – 24 kW/s	1 W/s – 48 kW/s

## Supplemental Characteristics (continued)

		N6791A	N6792A
<b>Protection Accuracy:</b>			
Programmable over-current	High range	0.2 % +0.1A	0.2 % +0.1A
	Low range	0.2 % +0.1A	0.2 % +0.1A
Fixed over-current	High range	21.42 A ±0.15 A	42.84 A ±0.24 A
	Low range	2.142 A ±0.15 A	4.284 A ±0.20 A
Fixed over-voltage		66 V ±0.35 V	66 V ±0.35 V
Fixed over-power		110 W	220 W
<b>N6705 Oscilloscope Measurement Accuracy:</b> (@ 25 °C ±5 °C. Applies to any individual point of the trace)			
Current high range		0.04 +16 mA	0.04 +23 mA
Current low range		0.04 +14 mA	0.04 +20 mA
Voltage		0.03 +13 mV	0.03 +13 mV
<b>Measurement Bandwidth:</b>			
Voltage & Current (rms)	-3 dB	20 kHz	20 kHz
	-1 dB	10 kHz	10 kHz
<b>Output Ripple and Noise:</b>			
Current (rms)		2 mA	3 mA
Voltage (rms)		5 mV	5 mV
<b>Programmable Short/Open:</b>			
Programmable short		80 mΩ	40 mΩ
Input Off Impedance		500 kΩ	500 kΩ
<b>Input Characteristic:</b>			
Approximate capacitance		0.7 μF in series with 5 Ω	1.5 μF in series with 2.5 Ω
<b>Reverse Current Capability:</b>	With the input off, load modules can tolerate reverse currents up the rated current input of the module.		
<b>Remote Sense Capability:</b>	Inputs can maintain specifications with up to a 1-volt drop per load lead. The load lead drop reduces the maximum available voltage at the load.		
<b>Series and Parallel Operation:</b>	Identically rated load modules <b>can</b> be operated directly in parallel. Load modules <b>cannot</b> be used in series with other load modules or any other N67xx modules.		

## Output Quadrant Characteristic

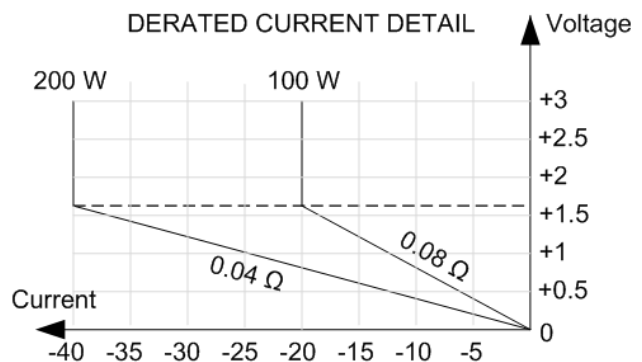
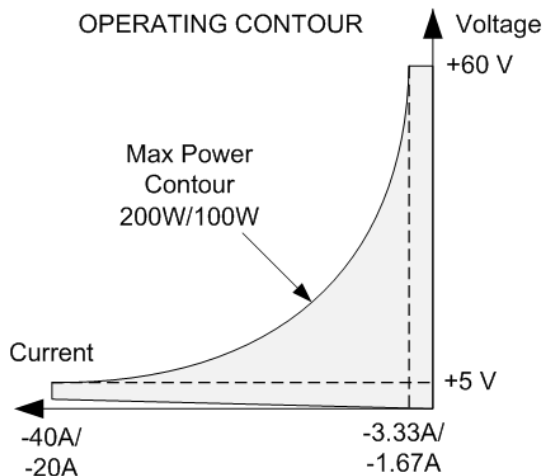

# Chapter 8

## Keysight N6700 and N6705 series Mainframes

Supplemental Characteristics .....	62
Outline Diagrams .....	64

Supplemental characteristics are not warranted but are descriptions of performance determined either by design or by type testing. All supplemental characteristics are typical unless otherwise noted.

### NOTE

Refer to the following documents for information about using and servicing the Keysight N6705 and N6700 series Mainframes.

*Keysight Model N6705C DC Power Analyzer Operating and Service Guide*

Go to [http:// literature.cdn.keysight.com/litweb/pdf/N6705C-90901.pdf](http://literature.cdn.keysight.com/litweb/pdf/N6705C-90901.pdf)

*Keysight Series N6700C Low-Profile Modular Power System Operating and Service Guide*

Go to <http:// literature.cdn.keysight.com/litweb/pdf/N6700C-90901.pdf>.

*Keysight Model N6705B DC Power Analyzer User's Guide*

Go to <http:// literature.cdn.keysight.com/litweb/pdf/N6705-90001.pdf>.

*Keysight Model N6705B DC Power Analyzer Service Guide*

Go to <http:// literature.cdn.keysight.com/litweb/pdf/N6705-90010.pdf>.

*Keysight N6700B/N6701A/N6702A Low-Profile MPS User's Guide*

Go to <http:// literature.cdn.keysight.com/litweb/pdf/5969-2937.pdf>.

*Keysight N6700B/N6701A/N6702A Low-Profile MPS Service Guide*

Go to <http:// literature.cdn.keysight.com/litweb/pdf/5969-2938.pdf>.

---

## Supplemental Characteristics

	N6700B, N6701A, N6702A N6700C, N6701C, N6702C	N6705B, N6705C
<b>Maximum Power Available for Modules:</b>		
Values represent combined power rating of all modules installed per mainframe.	400 W (for N6700B/C mainframes) 600 W (for N6701A/C mainframes) 1200 W (for N6702A/C mainframes)	600 W
<b>Front Panel Output Terminals:</b>		
Maximum current rating	N/A	20 A
<b>BNC Trigger Connectors:</b>		
I/O	N/A	Digital TTL level compatible
Maximum voltage	N/A	5 V
Maximum input pulse (N6705C only):	N/A	>6 ns, pos-going; >90 ns, neg-going
Output Pulse (N6705C only):	N/A	10 ms, negative going
<b>USB Current Ratings:</b>		
Front panel USB connector	N/A	200 mA
Rear panel USB connector	N/A	300 mA
<b>Data Storage:</b>		
Internal flash memory	8 Mbyte	4 Gbyte
<b>Protection Response Characteristic:</b>		
INH input	5 $\mu$ s from receipt of inhibit to start of shutdown	
Fault on coupled outputs	< 10 $\mu$ s from receipt of fault to start of shutdown	
<b>Command Processing Time:</b>		
	$\leq$ 1 ms from receipt of command to start of output change	
<b>Digital Port Characteristics:</b>		
Maximum voltage ratings	+16.5 VDC/- 5 VDC between pins (pin 8 is internally connected to chassis ground).	
Pins 1 and 2 as FLT output	Maximum low-level output voltage = 0.5 V @ 4 mA Maximum low-level sink current = 4 mA Typical high-level leakage current = 1 mA @ 16.5 VDC	
Pins 1 - 7 as digital/trigger outputs (pin 8 = common)	Maximum low-level output voltage = 0.5 V @ 4 mA; 1 V @ 50 mA; 1.75 V @ 100 mA Maximum low-level sink current = 100 mA Typical high-level leakage current = 0.8 mA @ 16.5 VDC	
Pins 1 - 7 as digital/trigger inputs and pin 3 as INH input (pin 8 = common)	Maximum low-level input voltage = 0.8 V Minimum high-level input voltage = 2 V Typical low-level current = 2 mA @ 0 V (internal 2.2k pull-up) Typical high-level leakage current = 0.12 mA @ 16.5 VDC	
<b>Interface Capabilities:</b>		
GPIB	SCPI - 1993, IEEE 488.2 compliant interface	
LXI Compliance	LXI Core 2011 - applies to N6700C, N6701C, N6702C, and N6705C LXI units Class C - applies to N6700B, N6701A, N6702A, and N6705B LXI units	
USB 2.0	Requires Keysight IO Library version M.01.01 or 14.0 and up	
10/100/1000 LAN	Requires Keysight IO Library version L.01.01 or 14.0 and up	
Built-in Web server	Requires a web browser	

## Supplemental Characteristics (continued)

	N6700B, N6701A, N6702A N6700C, N6701C, N6702C	N6705B, N6705C
<b>Regulatory Compliance:</b>		
EMC	Complies with European EMC Directive for test and measurement products. IEC/EN 61326-1; CISPR 11, Group 1, class A; AS/NZS CISPR 11; ICES/NMB-001 Complies with Australian standard and carries the RCM mark. This ISM device complies with Canadian ICES-001. Cet appareil ISM est conforme à la norme NMB-001 du Canada.	
Safety	Complies with European Low Voltage Directive and carries the CE-marking. Conforms to US and Canadian safety standards.	
<b>Environmental Conditions</b>		
Operating environment	Indoor use, installation category II (for AC input), pollution degree 2	
Temperature range	0°C to 55°C (output current is derated 1% per °C above 40°C ambient temperature)	
Relative humidity	Up to 95%	
Altitude	Up to 2000 meters	
Storage temperature	-30°C to 70°C	
<b>Acoustic Noise Declaration:</b>		
This statement is provided to comply with the requirements of the German Sound Emission Directive, from 18 January 1991.	Sound Pressure Lp, <70 dB(A), At Operator Position, Normal Operation, According to EN 27779 (Type Test). Schalldruckpegel Lp <70 dB(A), Am Arbeitsplatz, Normaler Betrieb, Nach EN 27779 (Typprüfung).	
<b>Output Terminal Isolation:</b>		
Maximum rating	No output terminal may be more than ±240 VDC from any other terminal or chassis ground.	
<b>N6781A/N6785A Note</b>	When using the AUX measurement input terminals on Models N6781A/N6785A, no output or input terminal may be more than ±60 VDC from any other terminal and chassis ground.	
<b>AC Input:</b>		
Input Ratings	~ 100 VAC – 240 VAC; 50/60/400Hz	~ 100 VAC – 240 VAC; 50/60/400Hz
Input Ranges	86–264 VAC; 47–63Hz; 380–420 Hz	86–264 VAC; 47–63Hz; 380–420 Hz
Power Consumption	1000 VA (N6700B/C) 1440 VA (N6701A/C) 1440 VA (N6702A/C @ < 180 VAC input) 2200 VA (N6702A/C @ > 180 VAC input)	1440 VA
Power Factor (Note 1)	0.99 @ nominal input and rated power	0.99 @ nominal input and rated power
Fuse	Internal fuse - not customer accessible.	
<b>N6702A/C Note</b>	AC mains circuits rated at 100–180 VAC <b>cannot</b> supply enough current to power the N6702 mainframe when operated at its full rated power. When connected to a 100–180 VAC mains, internal circuits will limit the power to modules to 600 W maximum.	
<b>Net Weight: (typical)</b>		
Mainframe with 4 modules	N6700B/C 12.73 kg / 28 lbs N6701A/C 11.82 kg / 26 lbs N6702A/C 14.09 kg / 31 lbs	16 kg / 35 lbs
Single-wide module	1.23 kg / 2.71 lbs	1.23 kg / 2.71 lbs
Double-wide module	2.1 kg / 4.63 lbs	2.1 kg / 4.63 lbs
<b>Dimensions:</b>		
Refer to the outline diagrams on the following page.		

Note 1: Under full load at 400 Hz, power factor drops from 0.99 @ 120 VAC to as low as 0.76 @ 265 VAC and degrades further with no load

# Outline Diagrams

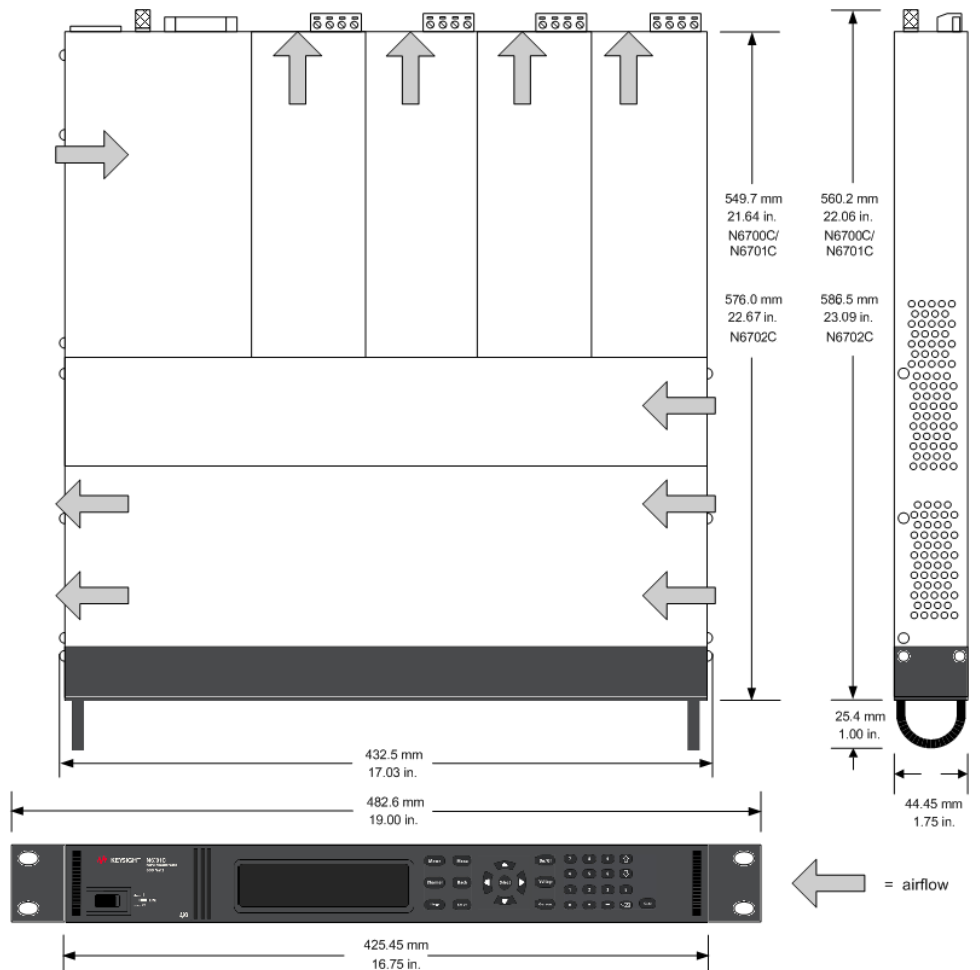
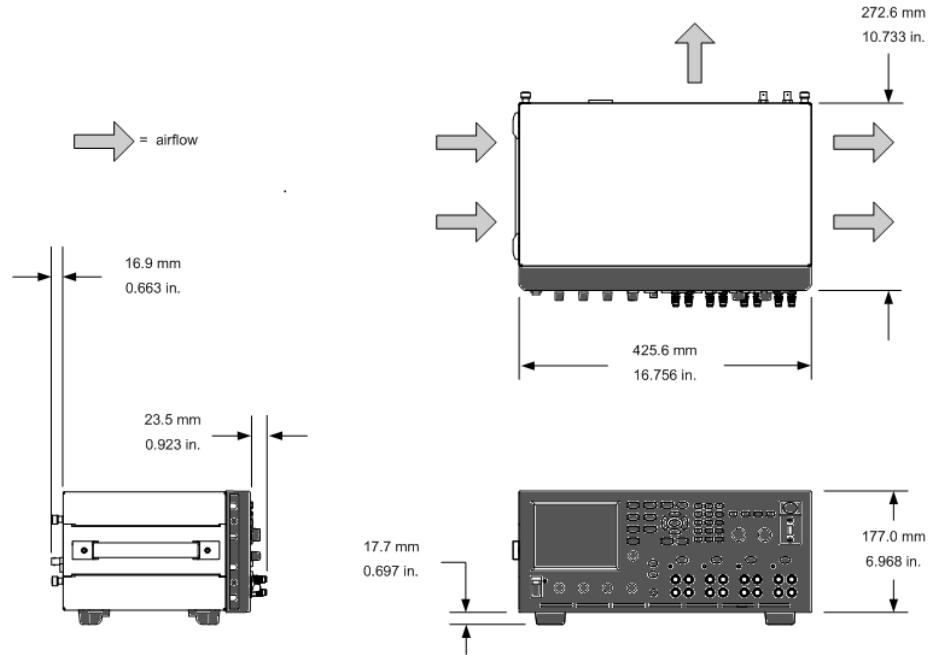

N6731B-N6792A DC Power & Load Modules  
N6700C-N6705C Mainframes  
Specifications Guide



