

Product Specification

10Gb/s DWDM 40km Multi-Rate Tunable SFP+ Transceiver FTLX6672MCC

PRODUCT FEATURES

- Hot-pluggable SFP+ footprint
- Supports 8.5 and 9.95 to 11.3 Gb/s
- Up to 40km link length
- 50GHz ITU-based channel spacing (C-Band) with a wavelength locker
- -5 / 70 °C case temperature range
- Single 3.3V power supply
- Monolithic MZM Tunable TOSA
- Limiting electrical interface PIN receiver
- Duplex LC connector
- Built-in digital diagnostic functions
- RoHS-6 compliant (lead-free)



APPLICATIONS

- DWDM 10Gb/s SONET/SDH
- DWDM 10Gb/s Ethernet & 10Gb/s Fibre Channel
- DWDM 10Gb/s SONET/SDH w/FEC
- DWDM 10Gb/s Ethernet and 10Gb/s Fibre Channel w/FEC

Finisar's FTLX6672MCC transceivers are Enhanced Small Form Factor Pluggable Tunable SFP+ transceivers designed for use in 10-Gigabit multi-rate links up to 40km of G.652 single mode fiber. They are compliant with SFF-8431¹, SFF-8432², SFF-8690⁸, and support SONET OC-192, SDH STM-64, and 10G Fibre Channel over 40km fiber. Digital diagnostics functions are available via a 2-wire serial interface, as specified in SFF-8472³. The optical transceiver is compliant per RoHS Directive 2011/65/EU⁴. See Finisar Application Note AN-2038⁵ for more details.

PRODUCT SELECTION

Product Part Number	RX Interface
FTLX6672MCC	Limiting

I. Pin Descriptions

Pin	Symbol	Name/Description	Ref.
1	V _{EET}	Transmitter Ground	1
2	T _{FAULT}	Transmitter Fault	2
3	T _{DIS}	Transmitter Disable. Laser output disabled on high or open.	3
4	SDA	2-wire Serial Interface Data Line	2
5	SCL	2-wire Serial Interface Clock Line	2
6	MOD_ABS	Module Absent. Grounded within the module	2
7	NA	Not Used	
8	RX_LOS	Loss of Signal indication. Logic 0 indicates normal operation.	4
9	NA	Not Used	
10	V _{EER}	Receiver Ground	1
11	V _{EER}	Receiver Ground	1
12	RD-	Receiver Inverted DATA out. AC Coupled.	
13	RD+	Receiver Non-inverted DATA out. AC Coupled.	
14	V _{EER}	Receiver Ground	1
15	V _{CCR}	Receiver Power Supply	5
16	V _{CCT}	Transmitter Power Supply	5
17	V _{EET}	Transmitter Ground	1
18	TD+	Transmitter Non-Inverted DATA in. AC Coupled.	
19	TD-	Transmitter Inverted DATA in. AC Coupled.	
20	V _{EET}	Transmitter Ground	1

Notes:

1. Circuit ground is internally isolated from chassis ground.
2. T_{FAULT} is an open collector/drain output, which should be pulled up with a 4.7k – 10k Ohms resistor on the host board if intended for use. Pull up voltage should be between 2.0V to V_{cc} + 0.3V. A high output indicates a transmitter fault caused by either the TX bias current or the TX output power exceeding the preset alarm thresholds. A low output indicates normal operation. In the low state, the output is pulled to <0.8V.
3. Laser output disabled on T_{DIS} >2.0V or open, enabled on T_{DIS} <0.8V.
4. LOS is open collector output. Should be pulled up with 4.7k – 10kΩ on host board to a voltage between 2.0V and 3.6V. Logic 0 indicates normal operation; logic 1 indicates loss of signal.
5. Internally connected

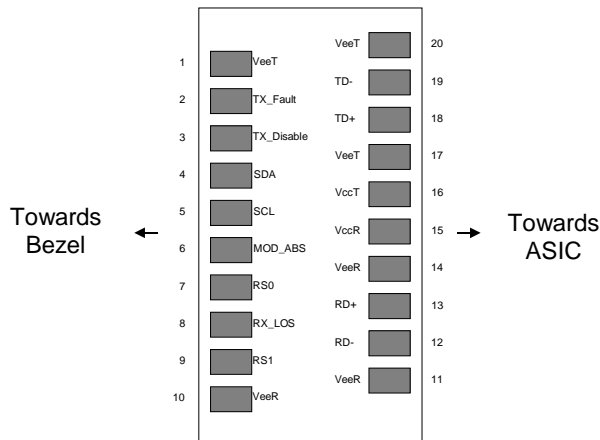

Figure 1. Diagram of Host Board Connector Block Pin Numbers and Names.

II. Absolute Maximum Ratings

Exceeding the limits below may damage the transceiver module permanently.

Parameter	Symbol	Min	Typ	Max	Unit	Ref.
Maximum Supply Voltage	V _{cc}	-0.5		4.0	V	
Storage Temperature	T _S	-40		85	°C	
Relative Humidity	RH	0		85	%	1
Receiver Optical Damage Threshold	R _{XDamage}	+3			dBm	

Notes:

1. Non-condensing

III. Electrical Characteristics (T_{OP} = -5 to 70 °C)

Parameter	Symbol	Min	Typ.	Max	Unit	Ref.
Supply Voltage	V _{cc}	3.14		3.46		
Supply Current	I _{cc}			650	mA	1
Module total power dissipation	P			2.0	W	2
Transmitter						
Input differential impedance	R _{in}	80	100	120	Ω	
Differential data input swing	V _{in,pp}	200		850	mV	3
Transmit Disable Voltage	V _D	V _{cc} -0.8		V _{cc}	V	
Transmit Enable Voltage	V _{EN}	V _{ee}		V _{ee} + 0.8	V	
Receiver						
Output differential impedance	R _{out}	80	100	120	Ω	
Differential data output swing	V _{out,pp}	100		850	mV	4
Output rise time and fall time	T _r , T _f	28			ps	4,5
LOS asserted	V _{LOS_A}	V _{cc} -0.8		V _{cc}	V	
LOS de-asserted	V _{LOS_D}	V _{ee}		V _{ee} +0.8	V	
Power Supply Noise Tolerance	V _{ccT} /V _{ccR}	Per SFF-8431 Rev 4.1			mV _{pp}	

Notes:

1. Compliant with the SFP+ Module Power Supply Requirements defined in [1], Tab. 8.
2. Maximum total power value is specified across the full temperature and voltage range.
3. Connected directly to TX data input pins.
4. Into 100Ω differential termination.
5. 20 – 80%. Measured with Module Compliance Test Board and OMA test pattern. Use of four 1's and four 0's sequence in the PRBS 9 is an acceptable alternative. SFF-8431 Rev 4.1.

IV. Optical Characteristics (TOP = -5 to 70 °C, VCC = 3.14 to 3.46 Volts)

Parameter		Symbol	Min	Typ	Max	Unit	Ref.
Transmitter (Tx)							
Average Launch Power		P_{AVE}	-1		+3	dBm	
Optical Wavelength		λ_c	As per ITU-T 694.1, 50GHz spacing 1528.77 to 1563.86			nm	
Side-Mode Suppression Ratio		SMSR	30			dB	
Optical Extinction Ratio		ER	8.2			dB	
Average Launch power when Tx is OFF		P_{OFF}			-30	dBm	
Tx Jitter 20kHz - 80MHz		T_{Xj1}			0.3	UI	
Tx Jitter 4MHz - 80MHz		T_{Xj2}			0.1	UI	
Relative Intensity Noise		RIN			-128	dB/Hz	
Center Wavelength	Beginning of Life	λ_{c_BOL}	z-1.5	z	z+1.5	GHz	
	End of Life	λ_{c_EOL}	z-2.5	z	z+2.5	GHz	
Receiver (Rx) at 0ps/nm							
Bit rate		BER					
8.5, 9.95		<1E-12	R_{SENS1}		-16.0	dBm	1
10.7 Gb/s		<1E-12	R_{SENS2}		-16.0	dBm	1
11.1 Gb/s		<1E-4	R_{SENS3}		-20.0	dBm	
11.3 Gb/s		<1E-4	R_{SENS4}		-20.0	dBm	
Overload (Average Power)		P_{AVE}	-1			dBm	
Optical Center Wavelength		λ_C	1260		1600	nm	
LOS De-Assert		LOS_D			-16	dBm	
LOS Assert		LOS_A	-26			dBm	
LOS Hysteresis		LOS_H	0.5			dB	
Receiver Reflectance		R_{rx}			-27	dB	

Notes:

1. Measured with worst ER=8.2dB; BER<10⁻¹²; 2³¹ – 1 PRBS.

FTLX6672MCC					
Receiver Sensitivity²					
Data rate (Gb/s)	BER	Dispersion (ps/nm)	Sensitivity back-to-back at OSNR>30dB (dBm)	Dispersion Penalty at OSNR>30dB (dB)	Threshold Adjust Required
9.95	1e-12	-800 to +800	-16	2	No
10.3	1e-12	-800 to +800	-16	2.5	No
10.7	1e-4	-800 to +800	-20	3	Yes ⁴
11.1	1e-4	-800 to +800	-20	3	Yes ⁴
11.3	1e-4	-800 to +800	-20	3.5	Yes ⁴
OSNR Performance³					
Data rate (Gb/s)	BER	Dispersion (ps/nm)	Min OSNR Back-to-back at Power: -14dBm to -2dBm (dB)	Max OSNR Penalty at Power: -14 to -2dBm (dB)	Threshold Adjust Required
9.95	1e-12	-800 to +800	24	4	Yes ⁴
10.3	1e-12	-800 to +800	24	4	Yes ⁴
10.7	1e-4	-800 to +800	16	4	Yes ⁴
11.1	1e-4	-800 to +800	16	4	Yes ⁴
11.3	1e-4	-800 to +800	17	4	Yes ⁴

Notes:

2. Measured at 1528-1600nm with worst ER; PRBS31.
3. All OSNR measurements are performed with 0.1nm resolution.
4. RxDTV control required for Limiting ROSA

V. General Specifications

Parameter	Symbol	Min	Typ	Max	Units	Ref.
Bit Rate	BR	8.5		11.3168	Gb/s	1
Max. Supported Link Length	L _{MAX}			40	km	2

Notes:

1. Tested with a $2^{31} - 1$ PRBS pattern at the BER defined in Table IV.
2. Over G.652 single mode fiber.

VI. Timing Parameters

Parameter	Symbol	Min	Max	Units	Ref.
Time to initialize cooled module	t_start_up_cooled		90	s	

VII. Environmental Specifications

Finisar FTLX6672MCC transceivers have an operating temperature range from -5 °C to +70 °C case temperature.

Parameter	Symbol	Min	Typ	Max	Units	Ref.
Case Operating Temperature	T _{op}	-5		70	°C	
Storage Temperature	T _{sto}	-40		85	°C	

VII. Regulatory Compliance

Finisar transceivers are Class 1 Laser Products and comply with US FDA regulations. These products are certified by TÜV and CSA to meet the Class 1 eye safety requirements of EN (IEC) 60825 and the electrical safety requirements of EN (IEC) 60950. Copies of certificates are available at Finisar Corporation upon request.

VIII. Digital Diagnostic Functions

Finisar FTLX6672MCC Tunable SFP+ transceivers support the 2-wire serial communication protocol as defined in the SFP MSA¹. It is very closely related to the memory map defined in the GBIC standard, with the same electrical specifications.

The standard SFP serial ID provides access to identification information that describes the transceiver's capabilities, standard interfaces, manufacturer, and other information.

Additionally, Finisar T-SFP+ transceivers provide an enhanced digital diagnostic monitoring interface, which allows real-time access to device operating parameters such as transceiver temperature, laser bias current, transmitted optical power, received optical power and transceiver supply voltage. It also defines a sophisticated system of alarm and warning flags, which alerts end-users when particular operating parameters are outside of a factory set normal range.

The SFP MSA defines a 256-byte memory map that is accessible over a 2-wire serial interface at the 8 bit address 1010000X (A0h). The digital diagnostic monitoring interface makes use of the 8 bit address 1010001X (A2h), so the originally defined serial ID memory map remains unchanged. The interface is identical to, and is thus fully backward compatible with both the GBIC Specification and the SFP Multi Source Agreement.

The operating and diagnostics information is monitored and reported by a Digital Diagnostics Transceiver Controller (DDTC) inside the transceiver, which is accessed through a 2-wire serial interface. When the serial protocol is activated, the serial clock signal (SCL, Mod Def 1) is generated by the host. The positive edge clocks data into the SFP transceiver into those segments of the E²PROM that are not write-protected. The negative edge clocks data from the SFP transceiver. The serial data signal (SDA, Mod Def 2) is bi-directional for serial data transfer. The host uses SDA in conjunction with SCL to mark the start and end of serial protocol activation. The memories are organized as a series of 8-bit data words that can be addressed individually or sequentially.

IX. Digital Diagnostic Specifications

FTLX6672MCC transceivers can be used in host systems that require either internally or externally calibrated digital diagnostics.

Parameter	Symbol	Units	Min	Max	Accuracy	Ref.
Accuracy						
Transceiver temperature	Δ_{DDTemp}	°C	-10	+75	±5 °C	1
Transceiver supply voltage	$\Delta_{DDVoltage}$	V	2.8	4.0	±3%	
Transmitter bias current	Δ_{DDBias}	mA	0	127	±10%	2
Transmitter output power	$\Delta_{DDTx-Power}$	dBm	-1	+5	±2dB	
Receiver average optical input power	$\Delta_{DDRx-Power}$	dBm	-20	-5	±2dB	

Notes:

1. Internally measured
2. The accuracy of the Tx bias current is 10% of the actual current from the laser driver to the laser

X. Start-Up Sequence

The FTLX6672MCC modules adhere to MSA SFF-8690 for wavelength / channel selection of these tunable modules. The module behavior is described in the flowchart below:

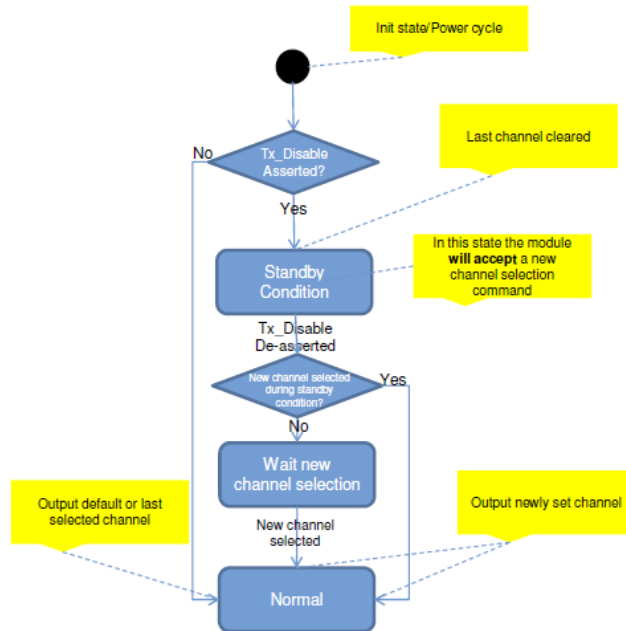

Alarm and Warning Threshold Values (A2h)

Address	Parameter	Threshold Values	UNITS
00-01	Temp High Alarm	80	C
02-03	Temp Low Alarm	-15	C
04-05	Temp High Warning	75	C
06-07	Temp Low Warning	-10	C
08-09	Voltage High Alarm	3.56	V
10-11	Voltage Low Alarm	3.04	V
12-13	Voltage High Warning	3.46	V
14-15	Voltage Low Warning	3.14	V
16-17	Bias High Alarm	130	mA
18-19	Bias Low Alarm	5	mA
20-21	Bias High Warning	120	mA
22-23	Bias Low Warning	10	mA
24-25	TX Power High Alarm	+5	dBm
26-27	TX Power Low Alarm	-3	dBm
28-29	TX Power High Warning	+4	dBm
30-31	TX Power Low Warning	-2	dBm
32-33	RX Power High Alarm	+1	dBm
34-35	RX Power Low Alarm	-20	dBm
36-37	RX Power High Warning	0	dBm
38-39	RX Power Low Warning	-18	dBm
40-55	Reserved		

XI. The FTLX6672MCC modules do not contain Internal CDRs.

XII. SFF-8431 Power-up Sequence

The typical power consumption of the FTLX6672MCC exceeds the limit of 1.5W specified in the SFF-8431 for the Power Level II device, for which the SFF-8431 recommends a power-up sequence. Per the SFF-8431, at the power-on a Power Level II transceiver can stay in Power Level I until the host enables the transceiver to complete its power-up sequence, reaching its operating power consumption into Power Level Mode II. Please, refer to SFF-8431 and Finisar Application Note AN-2076⁷ for additional details. The FTLX6672MCC is factory set to power-up directly to its operating conditions in Power Level Mode II. Upon request, it can be factory set to follow the above power-up sequence at the power-on. In power level I, the FTLX6672MCC does not carry traffic, but the 2-wire serial communication is active.

XIII. Mechanical Specifications

Finisar FTLX6672MCC SFP+ transceivers are compatible with the SFF-8432 specification for improved pluggable form factor, and shown here for reference purposes only. Bail color is green.

ITEM	DIM (mm)	TOL (mm)
A	9.00	± 0.3
B	9.60	± 0.5
C	11.90	± 0.5
D	13.85	± 0.15
E	13.65	± 0.15
F	2.80	± 0.2
G	1.00	± 0.2
H	4.00	REF
J	2.00	± 0.2
K	56.50	REF
L	1.60	± 0.5
M	2.25	± 0.1
N	1.80	± 0.1
P	37.10	± 0.3
Q	9.15	± 0.15
R	1.00	± 0.1
S	8.55	± 0.15
T	47.50	± 0.2
V	2.55	± 0.1
W	43.00	± 0.2
X	14.70	± 0.5
Z	0.55	± 0.15

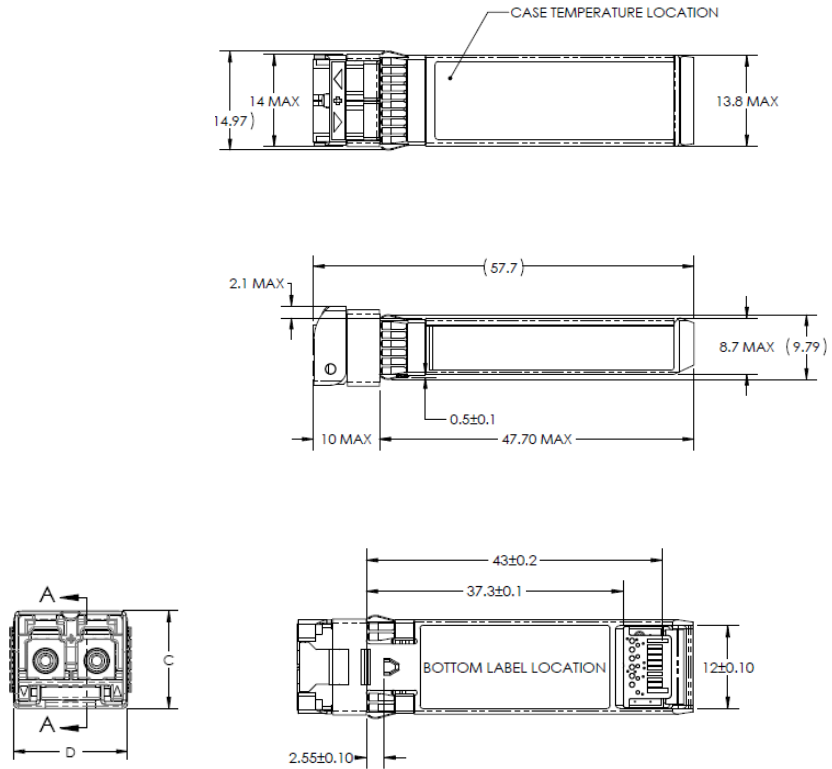
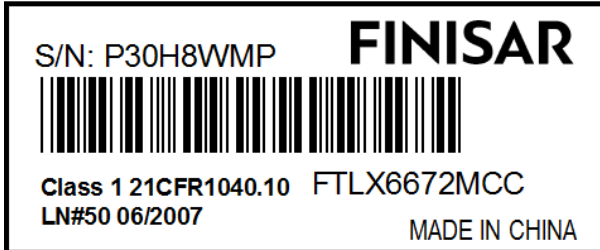

Figure 2. Mechanical Dimensions

Connector Recommendations

Product Label and Box Label

These are “subject to change without notice” and being used as a guideline for the format.



Sample of Product Label

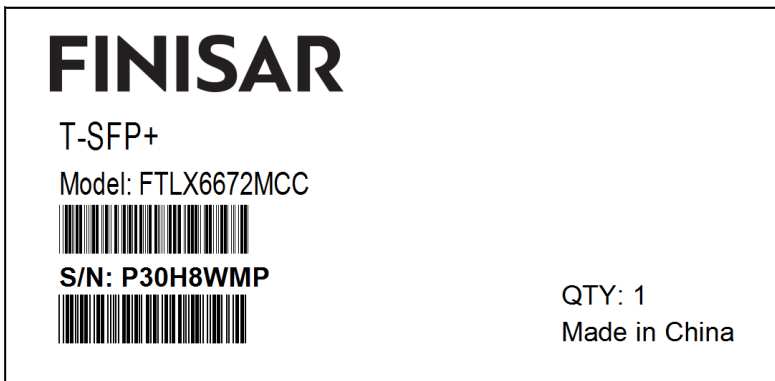

Sample of Box Label

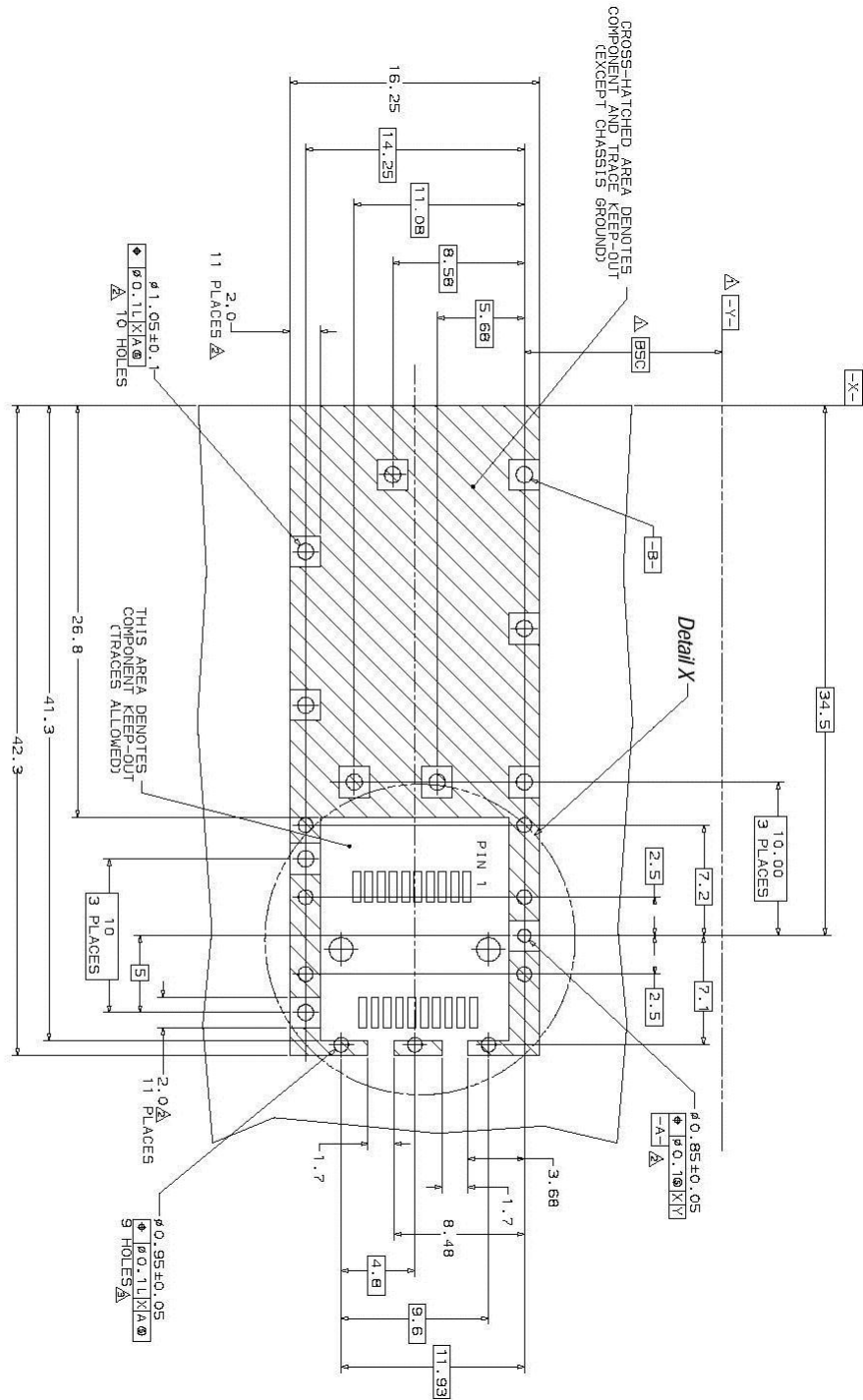
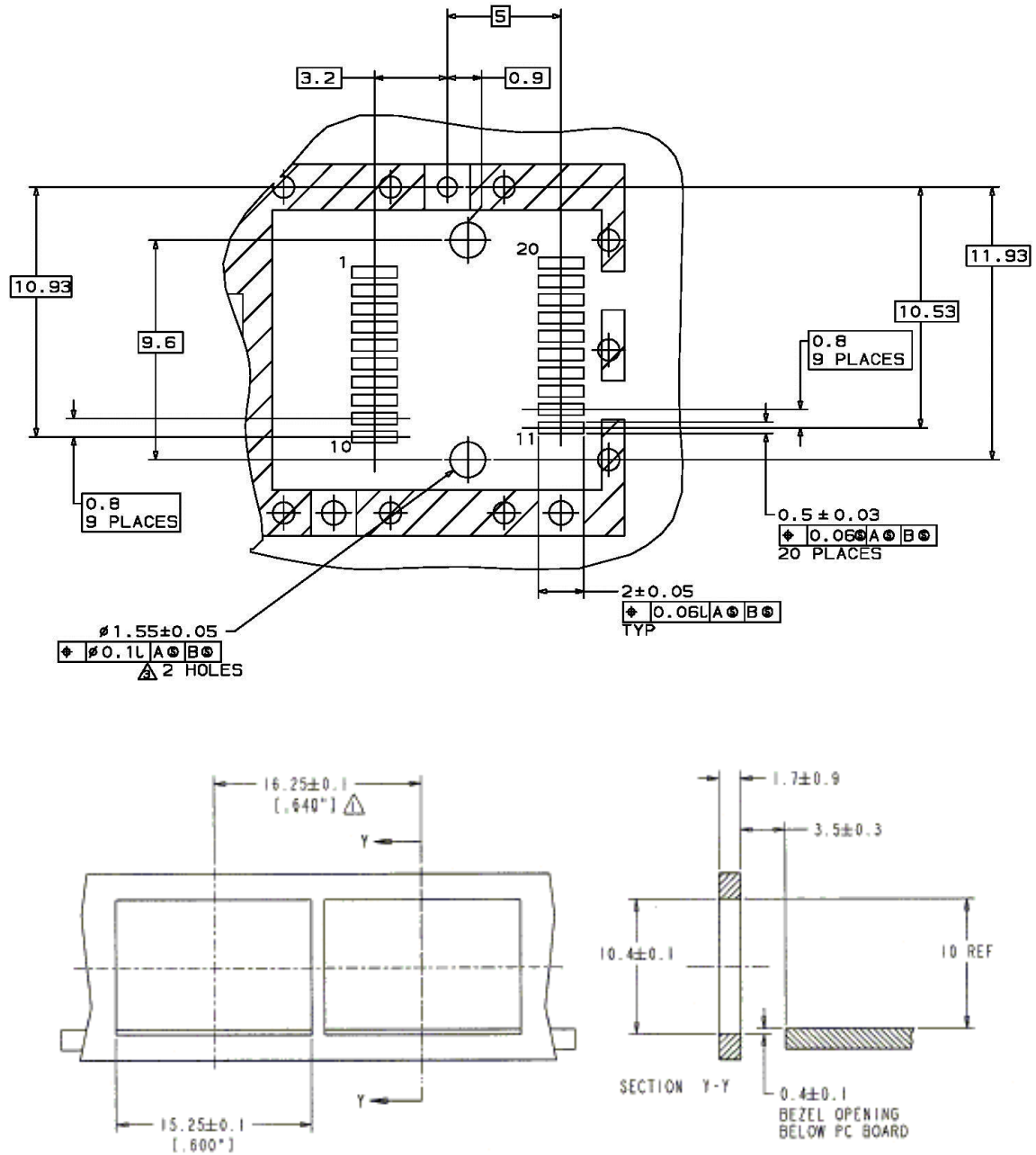

Figure 3. PCB Layout and Bezel Recommendations, as per [9]



NOTES:

1. MINIMUM PITCH ILLUSTRATED, ENGLISH DIMENSIONS ARE FOR REFERENCE ONLY

2. NOT RECOMMENDED FOR PCI EXPANSION CARD APPLICATIONS

Figure 4

XV. Host-Module Interface Diagram

To Be Provided in future release.

Figure 5

XVI. References

1. “Specifications for Enhanced 8.5 and 10 Gigabit Small Form Factor Pluggable Module ‘SFP+ ’”, SFF Document Number SFF-8431, Revision 4.1 (or later).
2. “Improved Pluggable Form factor”, SFF Document Number SFF-8432, Revision 4.2, April 18, 2007 (or later).
3. “Digital Diagnostics Monitoring Interface for Optical Transceivers”. SFF Document Number SFF-8472, Revision 11.3 (or later).
4. Directive 2011/65/EU of the European Council Parliament and of the Council, “on the restriction of the use of certain hazardous substances in electrical and electronic equipment”. Certain products may use one or more exemptions as allowed by the Directive.
5. “Application Note AN-2038: Finisar Implementation of RoHS Compliant Transceivers”, Finisar Corporation, January 21, 2005.
6. Small Form-factor Pluggable (SFP) Transceiver Multi-Source Agreement (MSA)
7. “Application Note AN-2076: SFP+ Level II Power Up Sequence”, Rev B
8. Tunable SFP+ MSA; SFF-8690

XVII. Revision History

Revision	Date	Description
A00	6/12/2015	Initial release
A01	April 2016	Update Finisar logo; add label samples, update RoHS statement
A02	June 2017	Modify box label sample

XVIII. For More Information

Finisar Corporation
 1389 Moffett Park Drive
 Sunnyvale, CA 94089-1133
 Tel. 1-408-548-1000
 Fax 1-408-541-6138
sales@finisar.com
www.finisar.com