

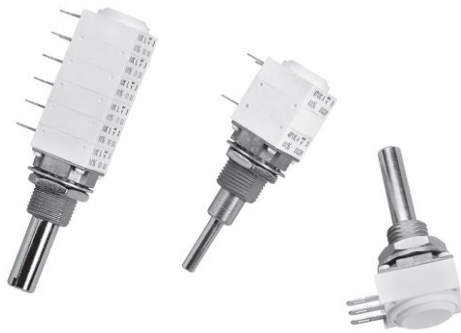

# 12.5 mm Modular Panel Potentiometer Cermet (P11S) or Conductive Plastic Elements (P11A)



## FEATURES

- 12.5 mm square single turn panel control
- Five shaft diameters and 29 terminal styles
- Multiple assemblies - up to seven modules
- Tests according to CECC 41000 or IEC 60393-1
- GAM T1
- P11S version for industrial, military, and aeronautics applications
- P11A version for professional audio applications
- Low current compatibility
- Shaft and panel sealed version
- Up to twenty-one indent positions
- Rotary and push/push switch options
- Concentric shafts
- Custom designs on request
- Trimmer version T11 (see document no. 51021)
- Material categorization: For definitions of compliance please see [www.vishay.com/doc?99912](http://www.vishay.com/doc?99912)



RoHS COMPLIANT

| VERSATILE | MODULAR | COMPACT | ROBUST |
|-----------|---------|---------|--------|
|-----------|---------|---------|--------|

### CONFIGURATION EXAMPLE - Dimensions in millimeters (inches) ± 0.5 mm (± 0.02")

Single module, single shaft, solder lugs, metric bushing and shaft

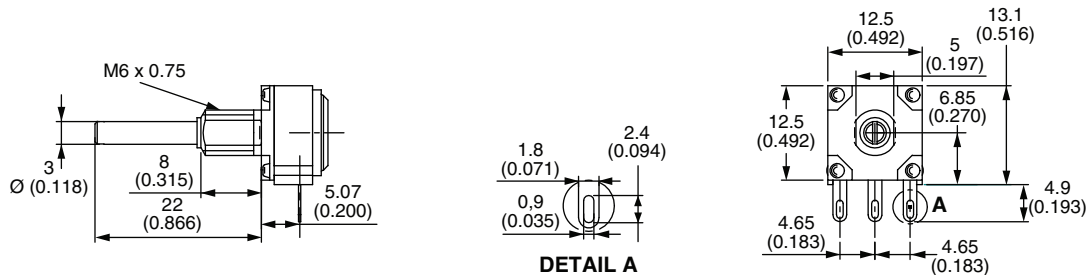

Single module, single shaft, vertical mounting, PC pins with support plate, metric bushing and shaft



Dual modules, single shaft, PC pins with front support plates, imperial bushing and shaft





**GENERAL SPECIFICATIONS**

| <b>ELECTRICAL (initial)</b>                   |                            |                              |
|---|----------------------------|------------------------------|
|   | <b>P11A</b>                | <b>P11S</b>                  |
| <b>Resistive Element</b>                      | Conductive plastic         | Cermet                       |
| <b>Electrical Travel</b>                      | 270° ± 10°                 | 270° ± 10°                   |
| <b>Resistance Range (1)</b>                   | <b>Linear Taper</b>        | 1 kΩ to 1 MΩ                 |
|   | <b>Non-Linear Taper</b>    | 470 Ω to 500 kΩ              |
| <b>Tolerance</b>                              | <b>Standard</b>            | ± 20 %                       |
|   | <b>On Request</b>          | -                            |
| <b>Taper</b>                                  |                            |                              |
| <b>Circuit Diagram</b>                        |                            |                              |
| <b>Power Rating at 70 °C</b>                  | <b>Linear Taper</b>        | 0.5 W at + 70 °C             |
|   | <b>Non-Linear Taper</b>    | 0.25 W at + 70 °C            |
|   | <b>Multiple Assemblies</b> | 0.25 W at + 70 °C per module |
|   |                            | 0.5 W at + 70 °C per module  |
|   |                            |                              |
| <b>Temperature Coefficient (Typical)</b>      | ± 500 ppm                  | ± 150 ppm                    |
| <b>Limiting Element Voltage</b>               | 350 V                      | 350 V                        |
| <b>End Resistance (Typical)</b>               | 2 Ω                        | 2 Ω                          |
| <b>Contact Resistance Variation (Typical)</b> | <b>Linear Taper</b>        | 1 %                          |
|   |                            | 2 % or 3 Ω                   |
| <b>Independent Linearity (Typical)</b>        | <b>Linear Taper</b>        | ± 5 %                        |
| <b>Insulation Resistance</b>                  | 10 <sup>6</sup> MΩ min.    | 10 <sup>6</sup> MΩ min.      |
| <b>Dielectric Strength</b>                    | 1500 V <sub>RMS</sub> min. | 1500 V <sub>RMS</sub> min.   |
| <b>Attenuation</b>                            | 90 dB max./0.05 dB min.    | -                            |
| <b>Mechanical Endurance</b>                   | 50 000 cycles              | 50 000 cycles                |

**Note**

(1) Consult Vishay Sfernice for other ohmic values



| <b>MECHANICAL</b> (initial)   |  |
|---|--|
| <b>Mechanical Travel</b>  | 300° ± 5°  |
| <b>Operating Torque (Typical)</b><br><br>Single and Dual Assemblies<br>Three to Seven Modules (Per Module)  | 0.4 Ncm to 1.8 Ncm max. (0.57 oz.-inch to 2.55 oz.-inch max.)<br>0.2 Ncm to 0.3 Ncm max. (0.28 oz.-inch to 0.42 oz.-inch max.) |
| <b>End Stop Torque</b><br><b>(All Bushing Except G and Concentric Shaft Configuration)</b><br><br>3 mm, 4 mm, and 1/8" Dia. Shafts<br>6 mm and 1/4" Dia. Shafts | 35 Ncm max. (2.9 lb-inch max.)<br>80 Ncm max. (6.8 lb-inch max.)   |
| <b>End Stop Torque for Bushing G</b><br><br>All Shafts Dia.   | 40 Ncm max. (3.4 lb-inch max.)   |
| <b>End Stop Torque for Concentric Shaft Configuration</b><br><br>3 mm and 1/8" Dia. Shafts<br>6 mm and 1/4" Dia. Shafts   | 25 Ncm max. (2.1 lb-inch max.)<br>80 Ncm max. (6.8 lb-inch max.)   |
| <b>Tightening Torque</b><br><br>6 mm, 7 mm, and 1/4" Dia. Bushings<br>10 mm and 3/8" Dia. Bushings  | 150 Ncm max. (13 lb-inch max.)<br>250 Ncm max. (21 lb-inch max.)   |
| <b>Weight</b>   | 7 g to 9 g per module (0.25 oz. to 0.32 oz.)   |

| <b>ENVIRONMENTAL</b>               |                     |                     |
|------------------------------------|---------------------|---------------------|
|                                    | <b>P11A</b>         | <b>P11S</b>         |
| <b>Operating Temperature Range</b> | - 55 °C to + 125 °C | - 55 °C to + 125 °C |
| <b>Climatic Category</b>           | 55/125/21           | 55/125/56           |
| <b>Sealing</b>                     | IP64                | IP64                |

| <b>MARKING</b>   |
|--|
| <ul style="list-style-type: none"> <li>• <b>Potentiometer Module</b><br/>Vishay logo, nominal ohmic value (<math>\Omega</math>, k<math>\Omega</math>, M<math>\Omega</math>), two stars identify P11A version, tolerance in % - variation law, manufacturing date (four digits), "3" for the lead 3</li> <li>• <b>Switch Module</b><br/>Version, manufacturing date (four digits), "c" for common lead</li> <li>• <b>Indent Module</b><br/>Version, manufacturing date (four digits)</li> </ul> |

| <b>PACKAGING</b>  |
|---|
| <ul style="list-style-type: none"> <li>• Box</li> </ul> |

| <b>PERFORMANCES</b>            |  |  |                            |                          |
|--------------------------------|--|--|----------------------------|--------------------------|
| TESTS                          | CONDITIONS   | TYPICAL VALUE AND DRIFTS                         |                            |                          |
|                                |  |  | P11S                       | P11A                     |
| <b>Electrical Endurance</b>    | 1000 h at rated power<br>90'/30' - ambient temp. 70 °C             | $\Delta R_T/R_T$<br>Contact resistance variation | ± 2 %<br>± 4 %             | ± 10 %<br>± 5 %          |
| <b>Change of Temperature</b>   | - 55 °C to + 125 °C, 5 cycles                                      | $\Delta R_T/R_T$                                 | ± 0.2 %                    | ± 0.5 %                  |
| <b>Damp Heat, Steady State</b> | + 40 °C, 93 % relative humidity<br>P11S: 56 days, P11A: 21 days    | $\Delta R_T/R_T$<br>Insulation resistance        | ± 2 %<br>> 1000 M $\Omega$ | ± 5 %<br>> 10 M $\Omega$ |
| <b>Mechanical Endurance</b>    | 50 000 cycles  | $\Delta R_T/R_T$<br>Contact resistance variation | ± 5 %<br>± 5 %             | ± 6 %<br>± 4 %           |
| <b>Climatic Sequence</b>       | Dry heat at + 125 °C/damp heat<br>cold - 55 °C/damp heat, 5 cycles | $\Delta R_T/R_T$                                 | ± 1 %                      | -                        |
| <b>Shock</b>                   | 50 g's, 11 ms<br>3 shocks - 3 directions                           | $\Delta R_T/R_T$<br>$\Delta R_{1-2}/R_{1-2}$     | ± 0.2 %<br>± 0.5 %         | ± 0.2 %<br>± 0.5 %       |
| <b>Vibration</b>               | 10 Hz to 55 Hz<br>0.75 mm or 10 g's, 6 h                           | $\Delta R_T/R_T$<br>$\Delta V_{1-2}/V_{1-3}$     | ± 0.2 %<br>± 0.5 %         | ± 0.2 %<br>± 0.5 %       |



| ORDERING INFORMATION (part number) |  |   |   |                                 |         |              |       |             |       |  |   |   |   |   |   |   |   |
|------------------------------------|--|---|---|---------------------------------|---------|--------------|-------|-------------|-------|--|---|---|---|---|---|---|---|
| P                                  | 1  | 1 | S | 2                               | Q       | 0            | E     | A           | S     | Y  | 0 | 0 | 1 | 0 | 3 | M | A |
| <b>MODEL</b>                       | <b>STYLE</b>   |   |   | <b>NUMBER OF MODULES</b>        | BUSHING | LOCATING PEG | SHAFT | SHAFT STYLE | LEADS | RESISTANCE CODE/TOLERANCE/TAPER OR SPECIAL |   |   |   |   |   |   |   |
| P11                                | S = Cermet element<br>A = Conductive plastic (audio) |   |   | 1<br>2<br>3<br>4<br>5<br>6<br>7 |         |              |       |             |       |  |   |   |   |   |   |   |   |

| STANDARD RESISTANCE ELEMENT DATA |                     |                      |                         |                     |                      |                         |                         |                      |                         |                     |                      |                         |
|----------------------------------|---------------------|----------------------|-------------------------|---------------------|----------------------|-------------------------|-------------------------|----------------------|-------------------------|---------------------|----------------------|-------------------------|
| STANDARD RESISTANCE VALUES       | P11S CERMET         |                      |                         |                     |                      |                         | P11A CONDUCTIVE PLASTIC |                      |                         |                     |                      |                         |
|                                  | LINEAR TAPER        |                      |                         | NON-LINEAR TAPER    |                      |                         | LINEAR TAPER            |                      |                         | NON-LINEAR TAPER    |                      |                         |
|                                  | MAX. POWER AT 70 °C | MAX. WORKING VOLTAGE | MAX. CUR. THROUGH WIPER | MAX. POWER AT 70 °C | MAX. WORKING VOLTAGE | MAX. CUR. THROUGH WIPER | MAX. POWER AT 70 °C     | MAX. WORKING VOLTAGE | MAX. CUR. THROUGH WIPER | MAX. POWER AT 70 °C | MAX. WORKING VOLTAGE | MAX. CUR. THROUGH WIPER |
| Ω                                | W                   | V                    | mA                      | W                   | V                    | mA                      | W                       | V                    | mA                      | W                   | V                    | mA                      |
| 22                               | 1                   | 4.69                 | 213                     |                     |                      |                         |                         |                      |                         |                     |                      |                         |
| 47                               | 1                   | 6.86                 | 146                     |                     |                      |                         |                         |                      |                         |                     |                      |                         |
| 50                               | 1                   | 7.07                 | 141                     |                     |                      |                         |                         |                      |                         |                     |                      |                         |
| 100                              | 1                   | 10.0                 | 100                     | 0.5                 | 7.07                 | 70.7                    |                         |                      |                         |                     |                      |                         |
| 220                              | 1                   | 14.8                 | 67.4                    | 0.5                 | 10.5                 | 47.7                    |                         |                      |                         |                     |                      |                         |
| 470                              | 1                   | 21.7                 | 46.1                    | 0.5                 | 15.3                 | 32.6                    |                         |                      |                         |                     |                      |                         |
| 500                              | 1                   | 22.4                 | 44.7                    | 0.5                 | 15.8                 | 31.6                    |                         |                      |                         | 0.25                | 11.2                 | 22.4                    |
| 1K                               | 1                   | 31.6                 | 31.6                    | 0.5                 | 22.4                 | 22.4                    | 0.5                     | 22.4                 | 22.4                    | 0.25                | 15.8                 | 15.8                    |
| 2.2K                             | 1                   | 46.9                 | 21.3                    | 0.5                 | 33.2                 | 15.1                    | 0.5                     | 33.2                 | 15.1                    | 0.25                | 23.5                 | 10.7                    |
| 4.7K                             | 1                   | 63.6                 | 14.5                    | 0.5                 | 48.5                 | 10.3                    | 0.5                     | 48.5                 | 10.3                    | 0.25                | 34.3                 | 7.29                    |
| 5K                               | 1                   | 70.7                 | 14.1                    | 0.5                 | 50.0                 | 10.0                    | 0.5                     | 50.0                 | 10.0                    | 0.25                | 35.4                 | 7.07                    |
| 10K                              | 1                   | 100                  | 10.0                    | 0.5                 | 70.7                 | 7.07                    | 0.5                     | 70.7                 | 7.07                    | 0.25                | 50.0                 | 5.00                    |
| 22K                              | 1                   | 148                  | 6.74                    | 0.5                 | 105                  | 4.77                    | 0.5                     | 105                  | 4.77                    | 0.25                | 74.2                 | 3.37                    |
| 47K                              | 1                   | 217                  | 4.61                    | 0.5                 | 153                  | 3.26                    | 0.5                     | 153                  | 3.26                    | 0.25                | 108                  | 2.31                    |
| 50K                              | 1                   | 224                  | 4.47                    | 0.5                 | 158                  | 3.16                    | 0.5                     | 158                  | 3.16                    | 0.25                | 112                  | 2.24                    |
| 100K                             | 1                   | 316                  | 3.16                    | 0.5                 | 224                  | 2.24                    | 0.5                     | 224                  | 2.24                    | 0.25                | 158                  | 1.58                    |
| 220K                             | 0.56                | 350                  | 1.59                    | 0.5                 | 332                  | 1.51                    | 0.5                     | 332                  | 1.51                    | 0.25                | 235                  | 1.07                    |
| 470K                             | 0.26                | 350                  | 0.75                    | 0.26                | 349                  | 0.74                    | 0.26                    | 350                  | 0.74                    | 0.25                | 343                  | 0.73                    |
| 500K                             | 0.25                | 350                  | 0.70                    | 0.25                | 350                  | 0.70                    | 0.25                    | 350                  | 0.70                    | 0.25                | 350                  | 0.70                    |
| 1M                               | 0.12                | 350                  | 0.35                    | 0.12                | 350                  | 0.35                    | 0.12                    | 350                  | 0.35                    |                     |                      |                         |
| 2.2M                             | 0.56                | 350                  | 0.16                    | 0.056               | 350                  | 0.16                    |                         |                      |                         |                     |                      |                         |
| 4.7M                             | 0.26                | 350                  | 0.074                   |                     |                      |                         |                         |                      |                         |                     |                      |                         |
| 5M                               | 0.25                | 350                  | 0.070                   |                     |                      |                         |                         |                      |                         |                     |                      |                         |
| 10M                              | 0.12                | 350                  | 0.035                   |                     |                      |                         |                         |                      |                         |                     |                      |                         |

| ORDERING INFORMATION (part number) |       |                   |   |   |   |   |              |       |             |           |  |      |      |             |   |      |      |    |   |      |      |    |   |      |      |     |   |      |      |     |   |      |      |           |   |   |   |                    |   |   |   |   |   |   |   |   |   |    |     |             |  |  |  |  |  |  |  |  |  |  |  |  |  |  |  |  |
|------------------------------------|-------|-------------------|---|---|---|---|--------------|-------|-------------|-----------|--|------|------|-------------|---|------|------|----|---|------|------|----|---|------|------|-----|---|------|------|-----|---|------|------|-----------|---|---|---|--------------------|---|---|---|---|---|---|---|---|---|----|-----|-------------|--|--|--|--|--|--|--|--|--|--|--|--|--|--|--|--|
| P                                  | 1     | 1                 | S   | 2 | Q | 0 | E            | A     | S           | Y         | 0  | 0    | 1    | 0           | 3 | M    | A    |    |   |      |      |    |   |      |      |     |   |      |      |     |   |      |      |           |   |   |   |                    |   |   |   |   |   |   |   |   |   |    |     |             |  |  |  |  |  |  |  |  |  |  |  |  |  |  |  |  |
| MODEL                              | STYLE | NUMBER OF MODULES | BUSHING   |   |   |   | LOCATING PEG | SHAFT | SHAFT STYLE | LEADS     | RESISTANCE CODE/TOLERANCE/TAPER OR SPECIAL |      |      |             |   |      |      |    |   |      |      |    |   |      |      |     |   |      |      |     |   |      |      |           |   |   |   |                    |   |   |   |   |   |   |   |   |   |    |     |             |  |  |  |  |  |  |  |  |  |  |  |  |  |  |  |  |
| P11                                |       |                   | <table border="1"> <thead> <tr> <th></th><th>Ø</th><th>L</th><th>Old Codes</th></tr> </thead> <tbody> <tr><td>A</td><td>1/4"</td><td>1/4"</td><td>7, 77, 77-3</td></tr> <tr><td>B</td><td>1/4"</td><td>3/8"</td><td>71</td></tr> <tr><td>C</td><td>1/4"</td><td>1/2"</td><td>72</td></tr> <tr><td>D</td><td>1/4"</td><td>3/8"</td><td>71H</td></tr> <tr><td>E</td><td>1/4"</td><td>1/2"</td><td>72H</td></tr> <tr><td>F</td><td>3/8"</td><td>3/8"</td><td>2, 03, 0-</td></tr> <tr><td>G</td><td>8</td><td>8</td><td>TP, QP, VP, 2P, 7P</td></tr> <tr><td>Q</td><td>7</td><td>8</td><td>Q</td></tr> <tr><td>T</td><td>6</td><td>8</td><td>T</td></tr> <tr><td>V</td><td>10</td><td>9.5</td><td>V, CC, CC-3</td></tr> </tbody> </table> |   |   |   |              | Ø     | L           | Old Codes | A  | 1/4" | 1/4" | 7, 77, 77-3 | B | 1/4" | 3/8" | 71 | C | 1/4" | 1/2" | 72 | D | 1/4" | 3/8" | 71H | E | 1/4" | 1/2" | 72H | F | 3/8" | 3/8" | 2, 03, 0- | G | 8 | 8 | TP, QP, VP, 2P, 7P | Q | 7 | 8 | Q | T | 6 | 8 | T | V | 10 | 9.5 | V, CC, CC-3 |  |  |  |  |  |  |  |  |  |  |  |  |  |  |  |  |
|                                    | Ø     | L                 | Old Codes   |   |   |   |              |       |             |           |  |      |      |             |   |      |      |    |   |      |      |    |   |      |      |     |   |      |      |     |   |      |      |           |   |   |   |                    |   |   |   |   |   |   |   |   |   |    |     |             |  |  |  |  |  |  |  |  |  |  |  |  |  |  |  |  |
| A                                  | 1/4"  | 1/4"              | 7, 77, 77-3   |   |   |   |              |       |             |           |  |      |      |             |   |      |      |    |   |      |      |    |   |      |      |     |   |      |      |     |   |      |      |           |   |   |   |                    |   |   |   |   |   |   |   |   |   |    |     |             |  |  |  |  |  |  |  |  |  |  |  |  |  |  |  |  |
| B                                  | 1/4"  | 3/8"              | 71  |   |   |   |              |       |             |           |  |      |      |             |   |      |      |    |   |      |      |    |   |      |      |     |   |      |      |     |   |      |      |           |   |   |   |                    |   |   |   |   |   |   |   |   |   |    |     |             |  |  |  |  |  |  |  |  |  |  |  |  |  |  |  |  |
| C                                  | 1/4"  | 1/2"              | 72  |   |   |   |              |       |             |           |  |      |      |             |   |      |      |    |   |      |      |    |   |      |      |     |   |      |      |     |   |      |      |           |   |   |   |                    |   |   |   |   |   |   |   |   |   |    |     |             |  |  |  |  |  |  |  |  |  |  |  |  |  |  |  |  |
| D                                  | 1/4"  | 3/8"              | 71H   |   |   |   |              |       |             |           |  |      |      |             |   |      |      |    |   |      |      |    |   |      |      |     |   |      |      |     |   |      |      |           |   |   |   |                    |   |   |   |   |   |   |   |   |   |    |     |             |  |  |  |  |  |  |  |  |  |  |  |  |  |  |  |  |
| E                                  | 1/4"  | 1/2"              | 72H   |   |   |   |              |       |             |           |  |      |      |             |   |      |      |    |   |      |      |    |   |      |      |     |   |      |      |     |   |      |      |           |   |   |   |                    |   |   |   |   |   |   |   |   |   |    |     |             |  |  |  |  |  |  |  |  |  |  |  |  |  |  |  |  |
| F                                  | 3/8"  | 3/8"              | 2, 03, 0-   |   |   |   |              |       |             |           |  |      |      |             |   |      |      |    |   |      |      |    |   |      |      |     |   |      |      |     |   |      |      |           |   |   |   |                    |   |   |   |   |   |   |   |   |   |    |     |             |  |  |  |  |  |  |  |  |  |  |  |  |  |  |  |  |
| G                                  | 8     | 8                 | TP, QP, VP, 2P, 7P  |   |   |   |              |       |             |           |  |      |      |             |   |      |      |    |   |      |      |    |   |      |      |     |   |      |      |     |   |      |      |           |   |   |   |                    |   |   |   |   |   |   |   |   |   |    |     |             |  |  |  |  |  |  |  |  |  |  |  |  |  |  |  |  |
| Q                                  | 7     | 8                 | Q   |   |   |   |              |       |             |           |  |      |      |             |   |      |      |    |   |      |      |    |   |      |      |     |   |      |      |     |   |      |      |           |   |   |   |                    |   |   |   |   |   |   |   |   |   |    |     |             |  |  |  |  |  |  |  |  |  |  |  |  |  |  |  |  |
| T                                  | 6     | 8                 | T   |   |   |   |              |       |             |           |  |      |      |             |   |      |      |    |   |      |      |    |   |      |      |     |   |      |      |     |   |      |      |           |   |   |   |                    |   |   |   |   |   |   |   |   |   |    |     |             |  |  |  |  |  |  |  |  |  |  |  |  |  |  |  |  |
| V                                  | 10    | 9.5               | V, CC, CC-3   |   |   |   |              |       |             |           |  |      |      |             |   |      |      |    |   |      |      |    |   |      |      |     |   |      |      |     |   |      |      |           |   |   |   |                    |   |   |   |   |   |   |   |   |   |    |     |             |  |  |  |  |  |  |  |  |  |  |  |  |  |  |  |  |

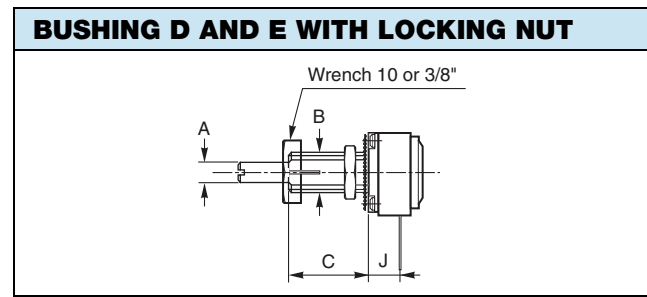
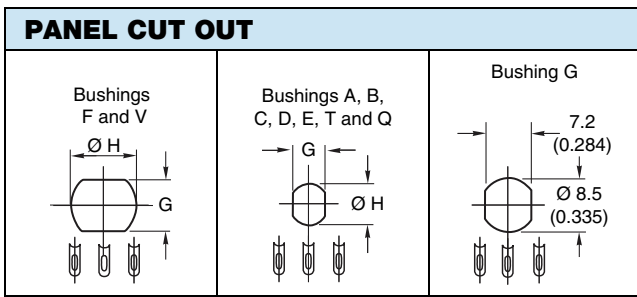
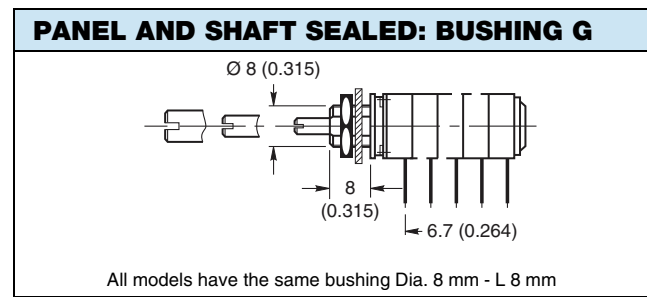
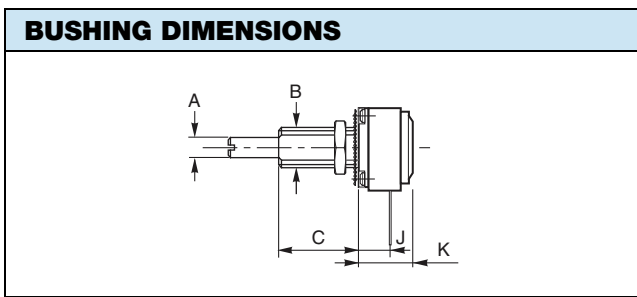

| BUSHINGS |                       | Ø | G                     | T   | Q   | V    | A     | B     | C                          | D       | E       | F     |  |  |
|----------|-----------------------|---|-----------------------|-----|-----|------|-------|-------|----------------------------|---------|---------|-------|--|--|
|          |                       |   | DIMENSIONS mm (± 0.5) |     |     |      |       |       | DIMENSIONS INCHES (± 0.02) |         |         |       |  |  |
| A        | Shafts                | Ø | All Dia.              | 3   | 4   | 6    | 1/8"  | 1/8"  | 1/8"                       | 1/8"    | 1/8"    | 1/4"  |  |  |
| B        | Bushing               | Ø | 8                     | 6   | 7   | 10   | 1/4"  | 1/4"  | 1/4"                       | 1/4"    | 1/4"    | 3/8"  |  |  |
| C        |                       | L | 8                     | 8   | 8   | 9.5  | 1/4"  | 3/8"  | 1/2"                       | 3/8"    | 1/2"    | 3/8"  |  |  |
| J        | Lead versions X.. Y.. |   | 6.7                   | 5   | 5   | 7    | 0.200 | 0.200 | 0.200                      | 0.200   | 0.200   | 0.278 |  |  |
| K        |                       |   | 10.4                  | 9.1 | 9.1 | 11.1 | 0.357 | 0.357 | 0.357                      | 0.357   | 0.357   | 0.436 |  |  |
| G        | Panel                 |   | 7.2                   | 5.2 | 6.2 | 8.2  | 0.197 | 0.197 | 0.197                      | 0.197   | 0.197   | 0.323 |  |  |
| H        | Cutout                | Ø | 8.5                   | 6.5 | 7.5 | 10.5 | 0.268 | 0.268 | 0.268                      | 0.268   | 0.268   | 0.394 |  |  |
|          | Thread                |   | 0.75                  |     |     |      |       |       | 32 threads/inch            |         |         |       |  |  |
|          | Wrench nut            |   | 12                    | 8   | 10  | 12   | 0.313 | 0.313 | 0.313                      | 0.313   | 0.313   | 0.500 |  |  |
|          | Style                 |   |                       |     |     |      |       |       |                            | Slotted | Slotted |       |  |  |

- Notes**
- Hardware supplied in separate bags
  - Slotted bushing for locking nut option

**ORDERING INFORMATION** (part number)

|       |       |                   |         |   |   |       |             |       |  |   |   |   |   |   |   |   |   |
|-------|-------|-------------------|---------|---|---|-------|-------------|-------|--|---|---|---|---|---|---|---|---|
| P     | 1     | 1                 | S       | 2   | Q | 0     | E           | A     | S  | Y | 0 | 0 | 1 | 0 | 3 | M | A |
| MODEL | STYLE | NUMBER OF MODULES | BUSHING | LOCATING PEG  |   | SHAFT | SHAFT STYLE | LEADS | RESISTANCE CODE/TOLERANCE/TAPER OR SPECIAL |   |   |   |   |   |   |   |   |
|       |       |                   |         | Old Codes<br>A = B24<br>B = B30<br>C = B53<br>0 = Without peg |   |       |             |       |  |   |   |   |   |   |   |   |   |

**LOCATING PEGS** (anti-rotation lug)

The locating peg is provided by a plate mounted on the bushing and positioned by the module sides. Four set positions are available, clock face orientation: 12, 3, 6, 9.

All P11 bushings have a double flat. When panel mounting holes have been punched accordingly, an anti-rotation lug is not necessary.

| CODE | VERSION | BUSHING A, B, C, D, E, T, Q | BUSHING F, V | EFFECTIVE HIGH PEG |
|------|---------|-----------------------------|--------------|--------------------|
| A    | Ø d mm  | 2                           | 2            | 0.7                |
|      | L mm    | 6.2                         | 6.2          |                    |
| B    | Ø d mm  | 2                           | 2            | 0.7                |
|      | L mm    | 7.75                        | 7.75         |                    |
| C    | Ø d mm  | -                           | 3.5          | 1.1                |
|      | L mm    | -                           | 13.5         |                    |

Locating pegs are supplied in separate bags with nuts and washers

| ORDERING INFORMATION (part number) |       |                   |         |              |       |                       |      |           |         |                     |             |       |  |   |   |   |   |
|------------------------------------|-------|-------------------|---------|--------------|-------|-----------------------|------|-----------|---------|---------------------|-------------|-------|--|---|---|---|---|
| P                                  | 1     | 1                 | S       | 2            | Q     | 0                     | E    | A         | S       | Y                   | 0           | 0     | 1  | 0 | 3 | M | A |
| MODEL                              | STYLE | NUMBER OF MODULES | BUSHING | LOCATING PEG | SHAFT |                       |      |           |         |                     | SHAFT STYLE | LEADS | RESISTANCE CODE/TOLERANCE/TAPER OR SPECIAL |   |   |   |   |
|                                    |       |                   |         |              |       | ∅                     | L    | Old Codes |         | S = Slotted         |             |       |  |   |   |   |   |
|                                    |       |                   |         |              |       | AA                    | 3    | 9.5       | K       | R = Round           |             |       |  |   |   |   |   |
|                                    |       |                   |         |              |       | AB                    | 3    | 12.5      | M       | F = Flatted         |             |       |  |   |   |   |   |
|                                    |       |                   |         |              |       | AJ                    | 3    | 22        | R       | K = Knurled/splined |             |       |  |   |   |   |   |
|                                    |       |                   |         |              |       | AP = Custom shaft     |      |           |         | D = Custom          |             |       |  |   |   |   |   |
|                                    |       |                   |         |              |       | BA                    | 1/8" | 3/8"      | CK      |                     |             |       |  |   |   |   |   |
|                                    |       |                   |         |              |       | BB                    | 1/8" | 1/2"      | CM      |                     |             |       |  |   |   |   |   |
|                                    |       |                   |         |              |       | BG                    | 1/8" | 5/8"      | CDM     |                     |             |       |  |   |   |   |   |
|                                    |       |                   |         |              |       | BG                    | 1/8" | 5/8"      | CD      |                     |             |       |  |   |   |   |   |
|                                    |       |                   |         |              |       | BH                    | 1/8" | 3/4"      | CH      |                     |             |       |  |   |   |   |   |
|                                    |       |                   |         |              |       | BJ                    | 1/8" | 7/8"      | CR      |                     |             |       |  |   |   |   |   |
|                                    |       |                   |         |              |       | CC = Concentric shaft |      |           |         |                     |             |       |  |   |   |   |   |
|                                    |       |                   |         |              |       | EA                    | 4    | 9.5       | E       |                     |             |       |  |   |   |   |   |
|                                    |       |                   |         |              |       | EB                    | 4    | 12.5      | F       |                     |             |       |  |   |   |   |   |
|                                    |       |                   |         |              |       | EJ                    | 4    | 22        | G       |                     |             |       |  |   |   |   |   |
|                                    |       |                   |         |              |       | FG                    | 6    | 16        | D       |                     |             |       |  |   |   |   |   |
|                                    |       |                   |         |              |       | FH                    | 6    | 19        | I       |                     |             |       |  |   |   |   |   |
|                                    |       |                   |         |              |       | FL                    | 6    | 25        | N       |                     |             |       |  |   |   |   |   |
|                                    |       |                   |         |              |       | FR                    | 6    | 50        | S       |                     |             |       |  |   |   |   |   |
|                                    |       |                   |         |              |       | GG                    | 1/4" | 5/8"      | VD      |                     |             |       |  |   |   |   |   |
|                                    |       |                   |         |              |       | GH                    | 1/4" | 3/4"      | VHM, VH |                     |             |       |  |   |   |   |   |
|                                    |       |                   |         |              |       | GJ                    | 1/4" | 7/8"      | VR      |                     |             |       |  |   |   |   |   |
|                                    |       |                   |         |              |       | GL                    | 1/4" | 1"        | VN      |                     |             |       |  |   |   |   |   |
|                                    |       |                   |         |              |       | GO                    | 1/4" | 1.5"      | VL      |                     |             |       |  |   |   |   |   |

**SHAFTS** in millimeters ± 0.5

The shaft length is always measured from the mounting face. Standard shafts are designed by a 3 letters code (3 digits). Shafts slots are aligned to ± 10° of the wiper position. All standard shafts are slotted except flatted and splined, see exceptions for bushing.

**FLATTED SHAFT**

Bushing: F Shaft: GHF

Bushing: A Shaft: BGF

**BUSHING: Q**  
**SPLINED SHAFT: FHK**

**CUSTOM SHAFTS**

When special shafts are required - flat, threaded ends, special shaft lengths, etc. a drawing is required.

| STANDARD COMBINATION OF SHAFT STYLES AND BUSHINGS |              |  |     |     |     |     |     |
|---|--------------|--|-----|-----|-----|-----|-----|
| SHAFT DIA.  | BUSHING CODE | SHAFT LENGTH AND STYLE AVAILABLE IN STANDARD (others on request) |     |     |     |     |     |
| 3   | T            | AAS  | ABS | AJS |     |     |     |
| 3.17  | A            | BAS  | BBS | BGS | BGF | BHS | BJS |
| 3.17  | B            | BBS  | BGS | BHS | BJS |     |     |
| 3.17  | C            | BGS  | BHS | BJS |     |     |     |
| 4   | Q            | EAS  | EBS | EJS | FHK |     |     |
| 6   | V            | FGS  | FLS | FRS |     |     |     |
| 6.35  | F            | GGs  | GHS | GJS | GLS | GOS | GHF |

| ORDERING INFORMATION (part number) |       |                   |         |              |       |             |                 |     |     |     |     |  |   |   |   |   |   |
|------------------------------------|-------|-------------------|---------|--------------|-------|-------------|-----------------|-----|-----|-----|-----|--|---|---|---|---|---|
| P                                  | 1     | 1                 | S       | 2            | Q     | 0           | E               | A   | S   | Y   | 0   | 0  | 1 | 0 | 3 | M | A |
| MODEL                              | STYLE | NUMBER OF MODULES | BUSHING | LOCATING PEG | SHAFT | SHAFT STYLE | LEADS           |     |     |     |     | RESISTANCE CODE/TOLERANCE/TAPER OR SPECIAL |   |   |   |   |   |
|                                    |       |                   |         |              |       |             | Available leads |     |     |     |     |  |   |   |   |   |   |
|                                    |       |                   |         |              |       |             | A00             | W00 | X00 | Y00 | Z00 |  |   |   |   |   |   |
|                                    |       |                   |         |              |       |             | A10             | W10 | X03 | Y03 | Z03 |  |   |   |   |   |   |
|                                    |       |                   |         |              |       |             | A13             | W20 | X04 | Y04 | Z04 |  |   |   |   |   |   |
|                                    |       |                   |         |              |       |             | A14             |     | X10 |     | Z10 |  |   |   |   |   |   |
|                                    |       |                   |         |              |       |             | A20             |     | X13 |     | Z13 |  |   |   |   |   |   |
|                                    |       |                   |         |              |       |             | A23             |     | X14 |     | Z14 |  |   |   |   |   |   |
|                                    |       |                   |         |              |       |             | A24             |     | X20 |     | Z20 |  |   |   |   |   |   |
|                                    |       |                   |         |              |       |             |                 |     | X23 |     | Z23 |  |   |   |   |   |   |
|                                    |       |                   |         |              |       |             |                 |     | X24 |     | Z24 |  |   |   |   |   |   |

| FIRST DIGIT |  | SECOND DIGIT |   | THIRD DIGIT |                                      |
|-------------|--|--------------|---|-------------|--------------------------------------|
| Y           | Soldering lugs   | 0            | Y = 4.65 (0.183")<br>A, X, Z, W = 5.08 (0.200") pin spacing<br>pins section 0.9 x 0.3 (0.035" x 0.012") | 0           | 5.08 (0.200") space between modules  |
| X           | PCB pins   | 1            | 2.54 (0.100") pin spacing<br>pin section 0.6 x 0.3 (0.024" x 0.012")                                    | 3           | 7.62 (0.300") space between modules  |
| Z           | PCB pins with front support plate                              | 2            | 5.08 (0.200") pin spacing<br>pins section 0.6 x 0.3 (0.024" x 0.012")                                   | 4           | 10.16 (0.400") space between modules |
| A           | PCB pins with front and back support plates                    |              |   |             |                                      |
| W           | PCB pins - vertical mounting with 2 extra pins - 1 module only |              |   |             |                                      |

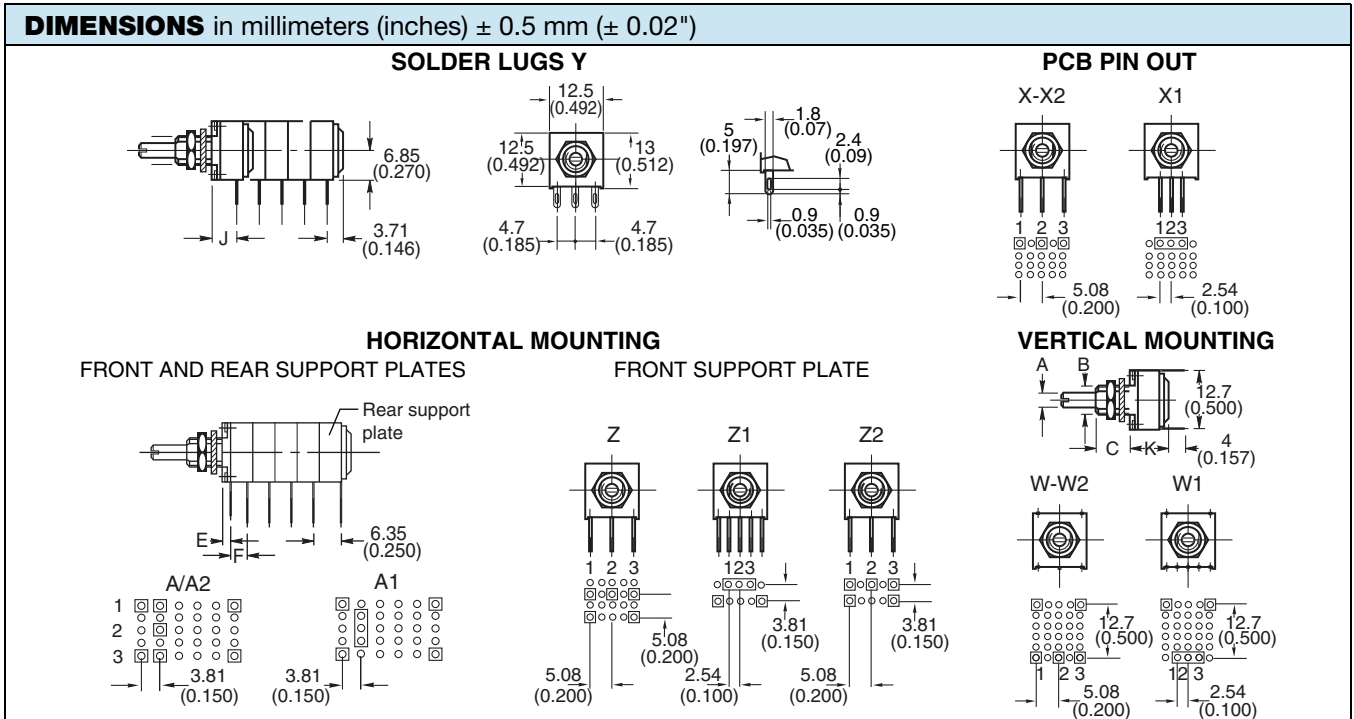

**THE POSITION OF EACH MODULE IS FREE**

| BUSHINGS |                              | G                        | T    | Q    | V    | A     | B                                | C     | D     | E     | F      |  |
|----------|------------------------------|--------------------------|------|------|------|-------|----------------------------------|-------|-------|-------|--------|--|
|          |                              | DIMENSIONS mm (± 0.5)    |      |      |      |       | DIMENSIONS INCHES (± 0.02)       |       |       |       |        |  |
| E        | Leads Z00                    | 3.15                     | 1.85 | 1.85 | 3.85 | 0.071 | 0.071                            | 0.071 | 0.071 | 0.071 | 0.150  |  |
| E        | Leads Z1, Z2, A..            | 2.8                      | 1.6  | 1.6  | 3.6  | 0.063 | 0.063                            | 0.063 | 0.063 | 0.063 | 0.140  |  |
| F        |                              | Leads Z0.: 5.08 (0.200") |      |      |      |       | Leads A., Z1, Z2.: 3.81 (0.150") |       |       |       |        |  |
| J        | Leads X., Y..                | 6.7                      | 5    | 5    | 7    | 0.200 | 0.200                            | 0.200 | 0.200 | 0.200 | 0.278  |  |
| E        | Leads Z0. with Rotary Switch | 1.45                     | 0.15 | 0.15 | 2.15 | 0.006 | 0.006                            | 0.006 | 0.006 | 0.006 | 0.0846 |  |





| ORDERING INFORMATION (part number) |       |                   |         |              |       |             |       |   |   |   |   |   |   |   |   |   |   |
|------------------------------------|-------|-------------------|---------|--------------|-------|-------------|-------|---|---|---|---|---|---|---|---|---|---|
| P                                  | 1     | 1                 | S       | 2            | Q     | 0           | E     | A   | S | Y | 0 | 0 | 1 | 0 | 3 | M | A |
| MODEL                              | STYLE | NUMBER OF MODULES | BUSHING | LOCATING PEG | SHAFT | SHAFT STYLE | LEADS | RESISTANCE CODE/<br>TOLERANCE/<br>TAPER OR SPECIAL  |   |   |   |   |   |   |   |   |   |
|                                    |       |                   |         |              |       |             |       | From 20 Ω to 10 MΩ<br>see instructions on<br>electrical specifications<br><br>Resistance code:<br>200 = 20 Ω to<br>106 = 10 MΩ<br><br>Tolerance code:<br>Standard:<br>M = ± 20 %<br>On request:<br>K = ± 10 %,<br>J = ± 5 % (cermet only)<br><br>Taper: A, L, W, F, S, R<br>or<br>special code<br>given by Vishay |   |   |   |   |   |   |   |   |   |

| SPECIAL CODES GIVEN BY VISHAY   |
|---|
| Option available: <ul style="list-style-type: none"> <li>• Custom shaft</li> <li>• Custom design on request</li> <li>• Specific linearity</li> <li>• Specific interlinearity</li> <li>• Specific taper</li> <li>• Multiple assemblies with various modules</li> </ul> |

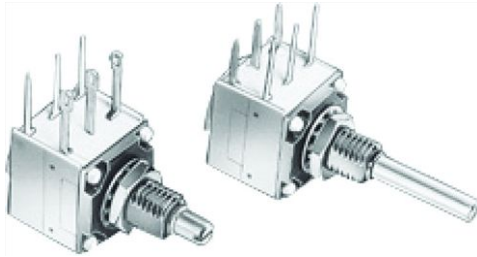
**P11 OPTION: ROTARY SWITCH MODULES**

- Rotary switches
- Current up to 2 A
- Actuation CW or CCW position
- Sealing IP60

**MODULES: RS ON/OFF SWITCH  
RSI CHANGEOVER SWITCH**

The position of each module is free.

RS and RSI rotary switches are housed in a standard P11 module size 12.7 mm x 12.7 mm x 5.08 mm (0.5" x 0.5" x 0.2"). They have the same terminal styles as the assembled electrical modules.

An assembly can comprise 1 or more switch modules.

Switch actuation is described as seen from the shaft end.

D: Means actuation in maximum CCW position

F: Means actuation in maximum CW position

The switch actuation travel is 25° with a total mechanical travel of 300° ± 5° and electrical travel of electrical modules is 238° ± 10°.

Leads finish: Gold plated

**RDS SINGLE POLE SWITCH, NORMALLY OPEN**

In full CCW position, the contact between 1 and 3 is open. It is made at the beginning of the travel in CW direction.

**RSF SINGLE POLE SWITCH, NORMALLY OPEN**

In full CW position, the contact between 1 and 3 is open. It is made at the beginning of the travel in CCW direction.

**RSID SINGLE POLE CHANGEOVER**

In full CCW position, the contact is made between 3 and 2 and open between 3 and 1. Switch actuation (CW direction) reverses these positions.

**RSIF SINGLE POLE CHANGEOVER**

In full CW position, the contact is made between 1 and 2 and open between 1 and 3. Switch actuation (CCW direction) reverses these positions.

**SWITCH SPECIFICATIONS**

|  |                                |                       |
|--|--------------------------------|-----------------------|
| Switching Power Maximum                | 62.5 VA v<br>15 VA =           |                       |
| Switching Current Maximum              | 0.25 A 250 V v<br>0.5 A 30 V = |                       |
| Maximum Current Through Element        | 2 A                            |                       |
| Contact Resistance                     | 100 mΩ                         |                       |
| Dielectric Strength                    | Terminal to Terminal           | 1000 V <sub>RMS</sub> |
|  | Terminal to Bushing            | 2000 V <sub>RMS</sub> |
| Maximum Voltage Operation              | 250 V v<br>30 V =              |                       |
| Insulation Resistance Between Contacts | 10 <sup>6</sup> MΩ             |                       |
| Life at P <sub>max.</sub>              | 10 000 actuations              |                       |
| Minimal Travel                         | 25°                            |                       |
| Operating Temperature                  | - 40 °C to + 85 °C             |                       |

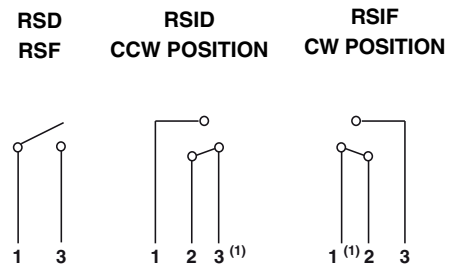
**ELECTRICAL DIAGRAM**

**Note**

(1) Common

**ORDERING INFORMATION** (First order only)

**RSID**

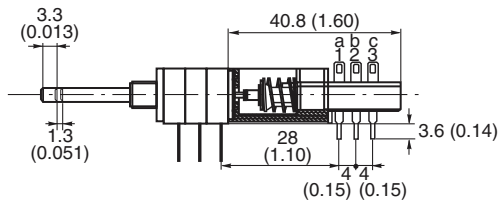
|             |   |
|-------------|---|
| <b>RSD</b>  | SPST: Single pole, open switch in CCW position - 2 pins       |
| <b>RSF</b>  | SPST: Single pole, open switch in CW position - 2 pins        |
| <b>RSID</b> | SPDT: Single pole, changeover switch in CCW position - 3 pins |
| <b>RSIF</b> | SPDT: Single pole, changeover switch in CW position - 3 pins  |

**P11 OPTION: PUSH/PUSH OR MOMENTARY/PUSH SWITCH MODULES**

- Push/push or momentary push
- Current up to 2 A
- Sealing IP60

**MODULES: PUSH/PUSH SWITCH RSPP  
MOMENTARY/PUSH SWITCH RSMP**

They have to be the last element of potentiometer

Options:

- 2 reversing switches F2      4 reversing switches F4
- 6 reversing switches F6      8 reversing switches F8

Not available with panel sealed option.

Number of modules before the switch limited to 3 modules.

Length of shaft (FMF) 25 mm maximum.

**RSPP F2: PUSH/PUSH SWITCH WITH TWO REVERSING SWITCHES**

Idle position: The contact is made between 1 and 2 and a and b. It is open between 2 and 3 and b and c.

Pushed position: The contact is made between 2 and 3 and b and c. It is open between 1 and 2 and a and b.

**SWITCH SPECIFICATIONS**

|  |                      |                       |
|--|----------------------|-----------------------|
| Switching Power Maximum                |                      | 50 VA v               |
| Switching Current Maximum              |                      | 0.5 A v               |
| Maximum Current Through Element        |                      | 2 A                   |
| Contact Resistance                     |                      | 100 mΩ                |
| Dielectric Strength                    | Terminal to Terminal | 1500 V <sub>RMS</sub> |
|  | Terminal to Bushing  | 2000 V <sub>RMS</sub> |
| Maximum Voltage Operation              |                      | 250 V v               |
| Insulation Resistance Between Contacts |                      | 10 <sup>3</sup> MΩ    |
| Life at P <sub>max.</sub>              |                      | 100 000 actuations    |
| Minimal Travel                         |                      | 3.3 mm to 4.7 mm      |
| Operating Temperature                  |                      | - 40 °C to + 70 °C    |

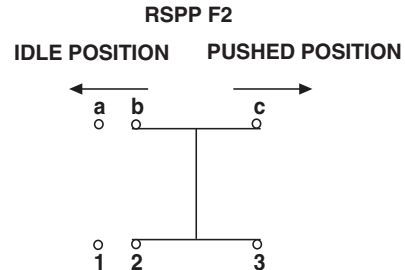
**ELECTRICAL DIAGRAM**

**ORDERING INFORMATION** (First order only for special code creation)

**RSPP**

**RSPP:** Push/push  
**RSMP:** Momentary/push

**F2**

**F2:** 2 reversing switches (standard version)  
**F4:** 4 reversing switches  
**F6:** 6 reversing switches  
**F8:** 8 reversing switches

**P11 OPTION: CONCENTRIC SHAFTS**

The CC concentric shaft versions allies the total flexibility of the P11 modular system to the advantage of having two separate shafts.

The outer 6 mm or 1/4" or 1/8" dia. shaft drives the modules situated immediately behind the panel, before the spacer module.

The inner 3 mm or 1/8" or 0.07" dia. shaft drives the modules situated after the spacer module.

Spacer is available with a choice of two spacer thickness: 5.08 mm designations or 2.54 mm designation. See dimensional drawing

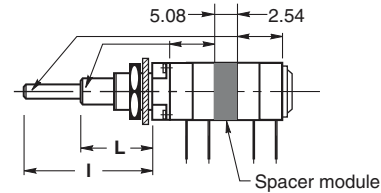

| BUSHING CODE | OUTER SHAFT DIAMETER |             |             | INNER SHAFT DIAMETER |             |             |
|--------------|----------------------|-------------|-------------|----------------------|-------------|-------------|
|              | DIAMETER             | LENGTH L    | SHAFT STYLE | DIAMETER             | LENGTH I    | SHAFT STYLE |
| V            | 6                    | 16          | R           | 3                    | 28.5        | R           |
| F            | 6.35 (1/4")          | 16          | R           | 3.17 (1/8")          | 28.5        | R           |
| A            | 3.17 (1/8")          | 12.7 (1/2") | R           | 1.8 (0.07")          | 22.2 (7/8") | R           |

**ORDERING INFORMATION** (First order only for special code creation)

5.08

**2.54:** Mechanical spacer of 2.54 mm

**5.08:** Mechanical spacer of 5.08 mm

Customer should define witch modules is driven by each shaft (see example of ordering information at the end of the datasheet)

**P11 OPTION: DETENT MODULES**

The detents mechanism is housed in a standard P11 module. Up to 21 detent positions available.

Count detents as follows: 1 for CCW position, 1 for full CW position, plus the other positions forming equal resistance increments (linear taper) - not equal angles.

Available: CVID - CVIF - CVIM  
CV3 - CV11 - CV21

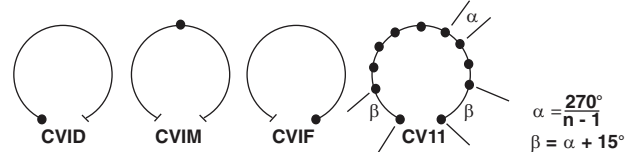

Mechanical endurance: 10 000 cycles

**ORDERING INFORMATION** (First order only for special code creation)

CV1M

- CV1M** 1 detent at half travel
- CV1M J84** CV1M with accuracy of center point  $\pm 2\%$  (all tapers except S)
- CV1D** 1 detent at CCW position
- CV1F** 1 detent at CW position
- CV3** 3 detents
- CV11** 11 detents
- CV21** 21 detents

**P11 OPTION: NEUTRAL MODULES "EN"**

Neutral or screen module is housed in a standard P11 module. It is used as a screen between two electrical modules.

The leads can be connected to ground.

**ORDERING INFORMATION** (First order only for special code creation)

EN

**EN** Neutral module

**P11 OPTION: CENTER CURRENT TAP “J”**

The extra terminal is a solder lug connected at 50 % of electrical travel and sited in the potentiometer module opposite the terminals.

Center tap presents a short circuit of 11° of travel.

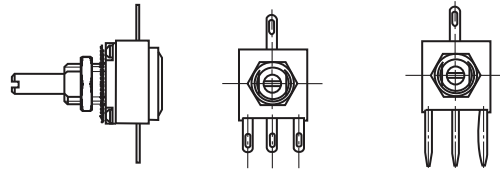
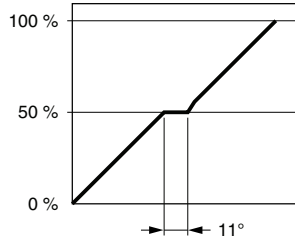

- Sealing IP60

**ORDERING INFORMATION** (First order only)

**J**

**J** Center tap

**P11 OPTION: SPECIAL LINEARITY - CONFORMITY**

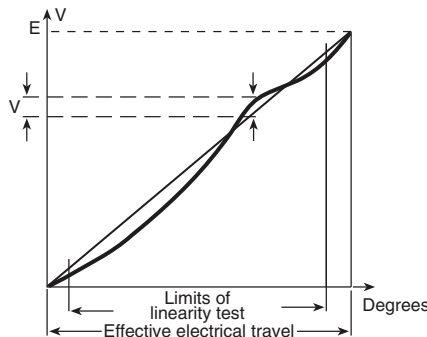

The independent linearity (conformity for the non-linear laws) is the maximum gap  $\Delta V$  between the actual variation curve and the theoretical variation curve the nearest to it. The linearity and the conformity are expressed in percentage of the total applied voltage E

$$\text{linearity conformity} = \frac{\pm \Delta V_{\text{max.}}}{E}$$

They are measured over 90 % of actual electrical travel (centered).

On request linearity can be guaranteed in linear taper.

**ORDERING INFORMATION** (First order only)

**J123**

**J123** Independent linearity  $\pm 3\%$  (linear law)  
**J145** Independent linearity  $\pm 2\%$  (linear law)

For other request, contact us.

**P11 OPTION: SPECIAL INTERLINEARITY - INTERCONFORMITY**

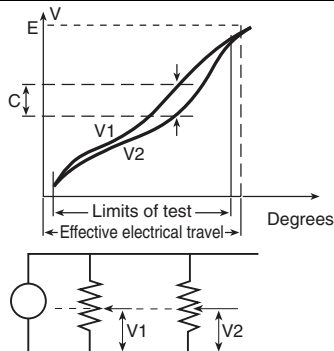

It is the maximum deviation between the actual voltage outputs of 2 or more pot modules in the same assembly. It is expressed as a percentage of the total applied voltage, or in dB attenuation.

Interlinearity is measured between 2 pot modules, over 20 to 90 % of the attenuation.

The interlinearity or interconformity is expressed as a percentage of the total applied voltage:

$$I \% = \frac{|C|}{E}$$

Or in decibels by comparison between outputs V1 and V2

$$I \text{ dB} = 20 \log \frac{V_1}{V_2}$$

**ORDERING INFORMATION** (First order only)

**J44**

**J44** Interlinearity  $\pm 2\%$  (linear taper)

For other request, contact us.



**EXAMPLES OF FIRST ORDER INFORMATION**

**FIRST EXAMPLE: Triple module (switch is counted as a module)**

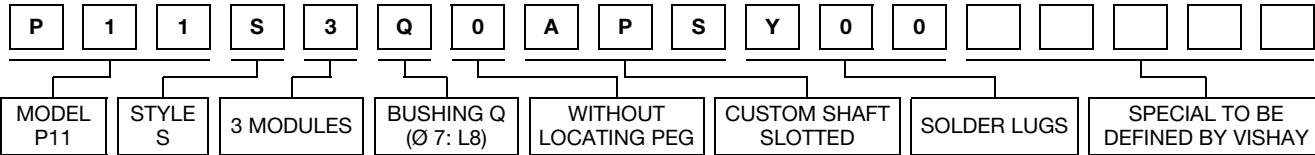

**ORDERING INFORMATION:**

|                   |                                       |      |
|-------------------|---------------------------------------|------|
| PART NUMBER       | P11S3Q0APSY00.....                    |      |
| SHAFT AND BUSHING | See drawing of special shaft attached |      |
| MODULE NO. 1      | RSID                                  |      |
| MODULE NO. 2      | 103 M A                               | J123 |
| MODULE NO. 3      | 503 M A                               | J    |

**SECOND EXAMPLE: Concentric shaft with 2 modules on each shaft**

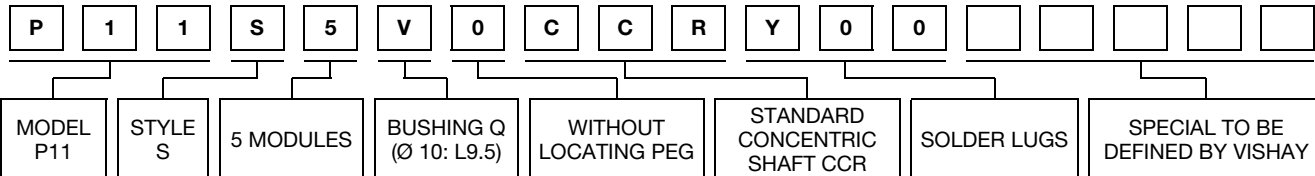

**ORDERING INFORMATION:**

|                   |                    |     |                           |
|-------------------|--------------------|-----|---------------------------|
| PART NUMBER       | P11S5V0CCRY00..... |     |                           |
| SHAFT AND BUSHING |                    |     |                           |
| MODULE NO. 1      | CV1M               |     | Driven by outer shaft     |
| MODULE NO. 2      | 502 K A            |     | Driven by outer shaft     |
| MODULE NO. 3      | 5.08               |     | Mechanical spacer 5.08 mm |
| MODULE NO. 4      | 103 M A            | J44 | Driven by inner shaft     |
| MODULE NO. 5      | 103 M A            | J44 | Driven by inner shaft     |

**PART NUMBER DESCRIPTION** (used on some Vishay document or label, for information only)

|       |         |         |              |       |             |       |       |      |       |         |         |                |
|-------|---------|---------|--------------|-------|-------------|-------|-------|------|-------|---------|---------|----------------|
| P11S  | 2       | Q       | 0            | EA    | S           | Y00   | 10K   | 20 % | A     |         |         | e3             |
| MODEL | MODULES | BUSHING | LOCATING PEG | SHAFT | SHAFT STYLE | LEADS | VALUE | TOL. | TAPER | SPECIAL | SPECIAL | LEAD (Pb)-FREE |



## Disclaimer

ALL PRODUCT, PRODUCT SPECIFICATIONS AND DATA ARE SUBJECT TO CHANGE WITHOUT NOTICE TO IMPROVE RELIABILITY, FUNCTION OR DESIGN OR OTHERWISE.

Vishay Intertechnology, Inc., its affiliates, agents, and employees, and all persons acting on its or their behalf (collectively, "Vishay"), disclaim any and all liability for any errors, inaccuracies or incompleteness contained in any datasheet or in any other disclosure relating to any product.

Vishay makes no warranty, representation or guarantee regarding the suitability of the products for any particular purpose or the continuing production of any product. To the maximum extent permitted by applicable law, Vishay disclaims (i) any and all liability arising out of the application or use of any product, (ii) any and all liability, including without limitation special, consequential or incidental damages, and (iii) any and all implied warranties, including warranties of fitness for particular purpose, non-infringement and merchantability.

Statements regarding the suitability of products for certain types of applications are based on Vishay's knowledge of typical requirements that are often placed on Vishay products in generic applications. Such statements are not binding statements about the suitability of products for a particular application. It is the customer's responsibility to validate that a particular product with the properties described in the product specification is suitable for use in a particular application. Parameters provided in datasheets and/or specifications may vary in different applications and performance may vary over time. All operating parameters, including typical parameters, must be validated for each customer application by the customer's technical experts. Product specifications do not expand or otherwise modify Vishay's terms and conditions of purchase, including but not limited to the warranty expressed therein.

Except as expressly indicated in writing, Vishay products are not designed for use in medical, life-saving, or life-sustaining applications or for any other application in which the failure of the Vishay product could result in personal injury or death. Customers using or selling Vishay products not expressly indicated for use in such applications do so at their own risk. Please contact authorized Vishay personnel to obtain written terms and conditions regarding products designed for such applications.

No license, express or implied, by estoppel or otherwise, to any intellectual property rights is granted by this document or by any conduct of Vishay. Product names and markings noted herein may be trademarks of their respective owners.

## Material Category Policy

**Vishay Intertechnology, Inc. hereby certifies that all its products that are identified as RoHS-Compliant fulfill the definitions and restrictions defined under Directive 2011/65/EU of The European Parliament and of the Council of June 8, 2011 on the restriction of the use of certain hazardous substances in electrical and electronic equipment (EEE) - recast, unless otherwise specified as non-compliant.**

**Please note that some Vishay documentation may still make reference to RoHS Directive 2002/95/EC. We confirm that all the products identified as being compliant to Directive 2002/95/EC conform to Directive 2011/65/EU.**

**Vishay Intertechnology, Inc. hereby certifies that all its products that are identified as Halogen-Free follow Halogen-Free requirements as per JEDEC JS709A standards. Please note that some Vishay documentation may still make reference to the IEC 61249-2-21 definition. We confirm that all the products identified as being compliant to IEC 61249-2-21 conform to JEDEC JS709A standards.**