

MoCA Triplex Filter 5 - 42 / 54 - 1002 / 1125 - 1675 MHz

Rev. V7

Description

- MACOM Technology Solution's MAFL-011018 is a surface mount triplex filter designed for MoCA applications

Features

- 75 Ohm
- SMT unit
- RoHS compliant

Electrical specifications: $T_A = 25^\circ\text{C}$, $Z_0 = 75\Omega$

Block Diagram

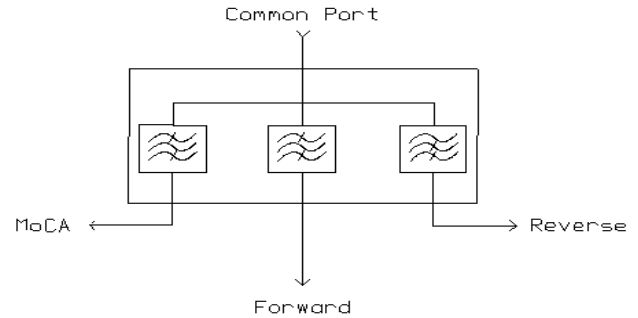

Parameter	Units	Min	Typ	Max
Reverse Path Insertion loss				
5-42 MHz	dB	-	1.2	1.5
Rejection				
54-88 MHz	dB	62	65	-
88-126 MHz	dB	62	65	-
126-860 MHz	dB	64	70	-
860-1002 MHz	dB	64	70	-
1125-1675 MHz	dB	60	64	-
1675-3000 MHz	dB	30	50	-
Forward path Insertion loss				
54-88 MHz	dB	-	1.5	2.0
88-860 MHz	dB	-	0.75	1.5
860-1002 MHz	dB	-	2.75	2.75
Rejection				
5-38 MHz	dB	50	55	-
38-42 MHz	dB	50	52	-
1125 - 1675 MHz	dB	43	45	-
1675-3000 MHz	dB	20	30	-
MoCA Path Insertion Loss				
1125-1150 MHz	dB	-	2.8	3.0
1150-1650 MHz	dB	-	2.5	2.7
1650-1675 MHz	dB	-	2.5	3.0
Rejection				
5-42 MHz	dB	49	70	-
54-1002 MHz	dB	49	55	-
2300-3000 MHz	dB	25	35	-

Parameter	Units	Min	Typ	Max
Input Return Loss				
5-42 MHz	dB	16	18	-
54-860MHz	dB	16	18	-
860-1002MHz	dB	12	16	-
1125-1675 MHz	dB	12	16	-
Isolation				
Forward to Reverse				
5-38 MHz	dB	55	58	-
38-42 MHz	dB	50	52	-
54-88 MHz	dB	60	65	-
88-126 MHz	dB	60	65	-
126-860 MHz	dB	60	65	-
860-1002 MHz	dB	60	65	-
Forward to MoCA				
5-42 MHz	dB	49	70	-
54-88 MHz	dB	49	70	-
88-126 MHz	dB	49	70	-
126-860 MHz	dB	49	53	-
860-1002 MHz	dB	49	55	-
1125-1150 MHz	dB	43	45	-
1150-1650 MHz	dB	43	50	-
1650-1675 MHz	dB	43	50	-

Pin Configuration

Function	Pin Number
MoCA Port	1
Forward Port	4
Reverse Port	7
Common Port	14
Ground	2, 3, 5, 6, 8-13, 15-20

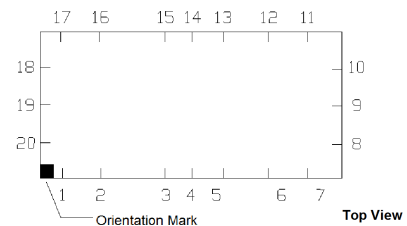

Recommended Maximum Ratings

Parameter	Absolute maximum
RF power	250mW
DC current	30mA
Operating temperature	-40°C to +85°C
Storage temperature	-40°C to +85°C

* Restrictions on Hazardous Substances, European Union Directive 2002/95/EC.

1

MA-COM Technology Solutions Inc. (MACOM) and its affiliates reserve the right to make changes to the product(s) or information contained herein without notice. Visit www.macomtech.com for additional data sheets and product information.

- North America Tel: 800.366.2266 / Fax: 978.366.2266
- Europe Tel: 44.1908.574.200 / Fax: 44.1908.574.300
- Asia/Pacific Tel: 81.44.844.8296 / Fax: 81.44.844.8298

Filter Dimensions

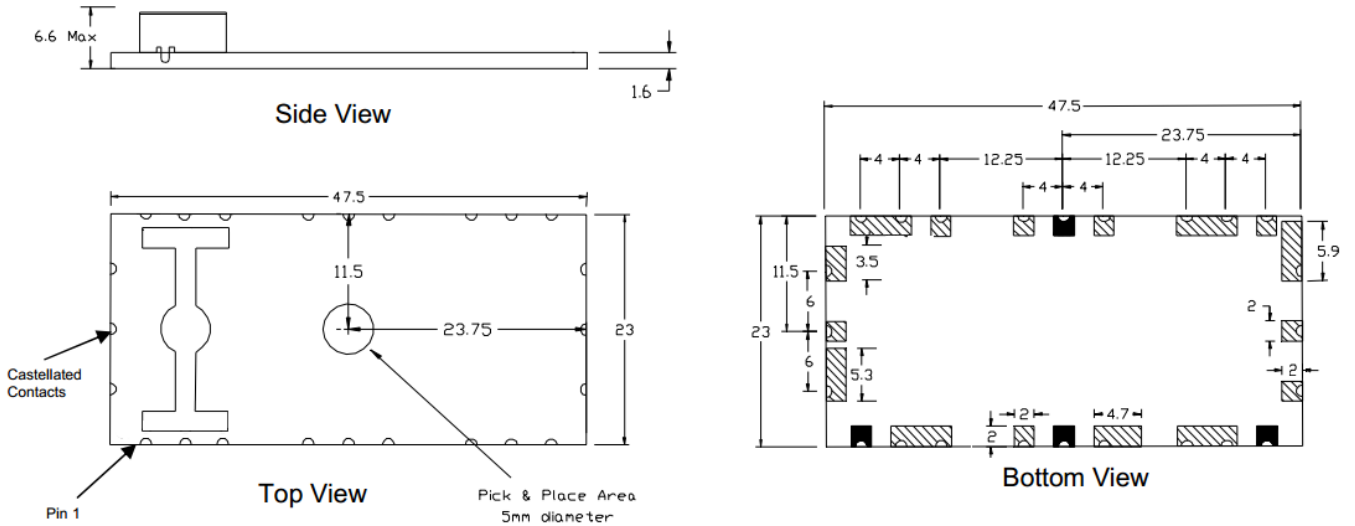

Dimensions in mm. Tolerance: .x ± 0.1 unless otherwise noted

Solder Resist Colour: Green

PCB Pad Finish: ENIG

Application Schematic

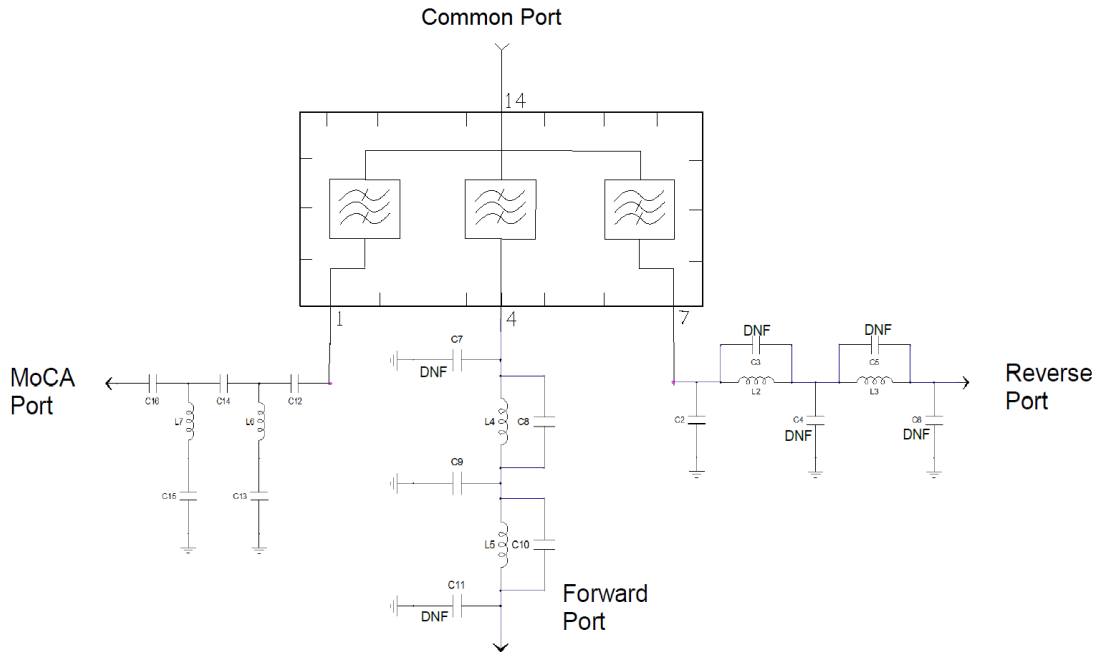

DNF: Do Not Fit

* Restrictions on Hazardous Substances, European Union Directive 2002/95/EC.

Recommended Application Layout

Dimensions are millimetres.

Tolerance: $.x \pm 0.1\text{mm}$, except where specified.

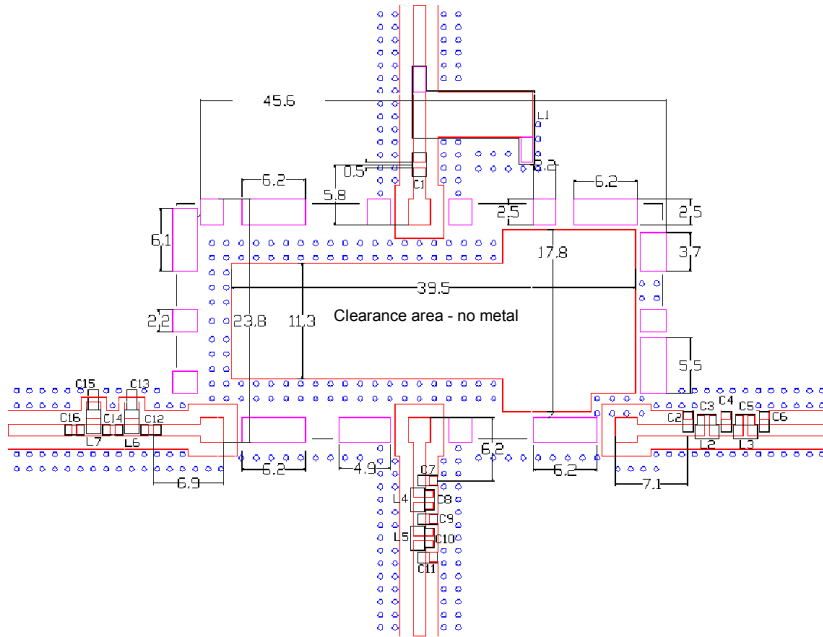

NOTE: Any deviation from recommended footprint will compromise the filter performance
 For optimal filter performance the 4 transmission lines need to be at 75 Ω impedance
 Substrate is 1.6mm thick FR4
 Track dimension = 1.15mm
 Gap dimension = 1.3mm

Recommended Component Values

Description Ref	Des	Qty
RES,SMT,0603,Zero Ohm	C1,L3	2
CAP,SMT,0402,27pF,+/-2%,50V,C0G	C2	1
Do Not Fit (DNF)	C3,C4,C5,C6, C7,C11,L1	7
CAP,SMT,0402,3.0pF,+/-0.25%,50V,C0G	C8,C15	2
CAP,SMT,0402,1.5pF,+/-0.1pF,50V,C0G	C9	1
CAP,SMT,0402,0.75pF,+/-0.1pF,50V,C0G	C10	1
CAP,SMT,0402,2.0pF,+/-0.1pF,50V,COG	C12	1
CAP,SMT,0402,7.5pF,+/-0.25pF,50V,C0G	C13	1
RES,SMT,0402,Zero Ohm	C14,C16	2
IND,SMT,0603,220nH	L2	1
IND,SMT,0603,5.6nH	L4	1
IND,SMT,0603,6.8nH	L5	1
IND,SMT,0603,12nH	L6	1
IND,SMT,0603,22nH	L7	1

- It is not recommended to run tracks under the filter.
- RF shield should be kept a minimum of 10mm above the filter
- A ground is required on the top layer of the application PCB. Recommended ground pattern shown. A clearance area in the centre of the application ground is required as shown.
- This ground plane is connected to the filter ground plane and forms a 75 Ω co-planar wave guide for the input and output RF transmission lines.

* Restrictions on Hazardous Substances, European Union Directive 2002/95/EC.

MoCA Triplex Filter 5 - 42 / 54 - 1002 / 1125 - 1675 MHz

Rev. V7

Common Port Return Loss

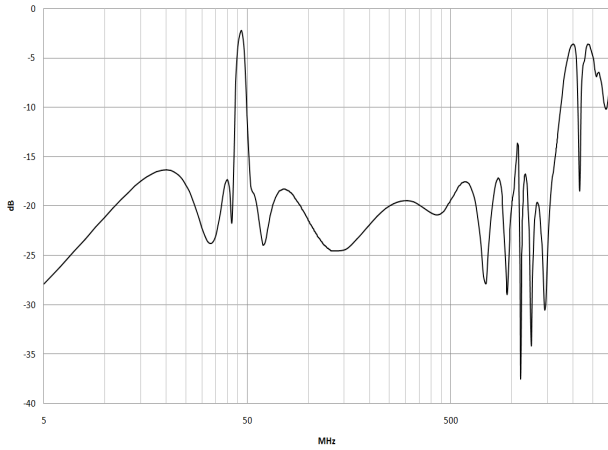

Reverse Path

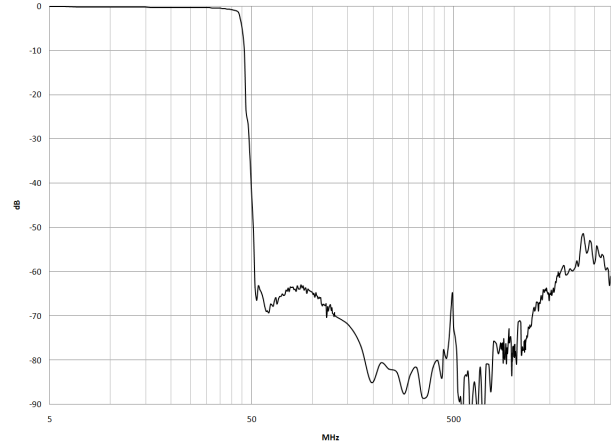

Forward Path

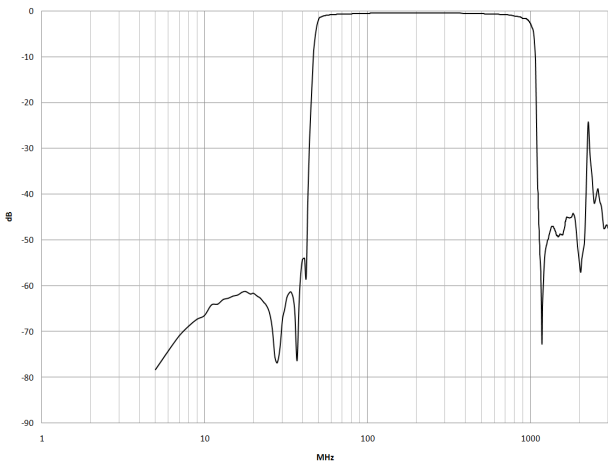

MoCA Path

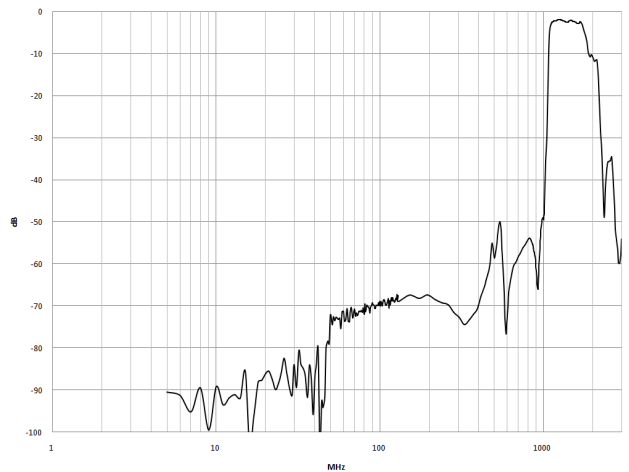

Reverse to Forward Path Isolation

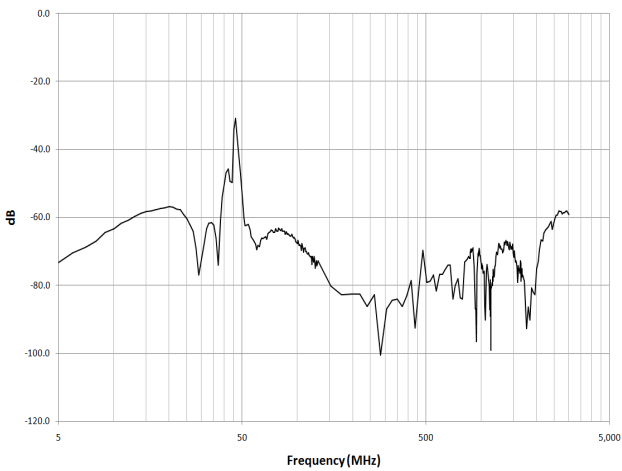

Forward to MoCA Path Isolation

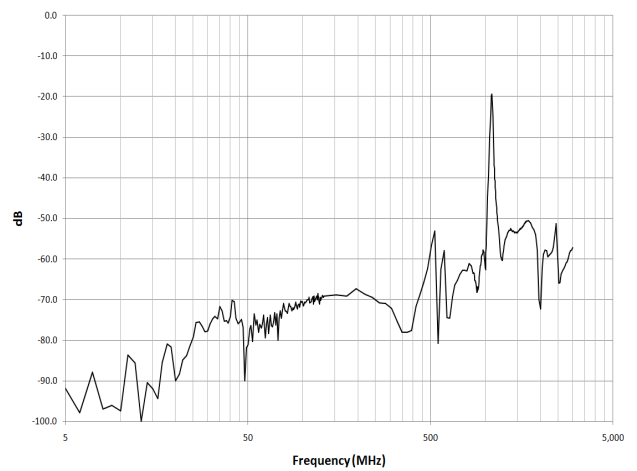

* Restrictions on Hazardous Substances, European Union Directive 2002/95/EC.

MAFL-011018



MoCA Triplex Filter
5 - 42 / 54 - 1002 / 1125 - 1675 MHz

Rev. V7

Tape & Reel Information

Parameter	Units	Value
Qty per reel	-	200
Reel Size	mm	330
Tape Width	mm	72.0
Pitch	mm	28.0
Ao	mm	23.3
Bo	mm	47.8
Ko	mm	6.8
Orientation	-	F54
Reference Application Note ANI-019 for orientation		

Ordering Information

Part Number	Package
MAFL-011018	Tape & Reel

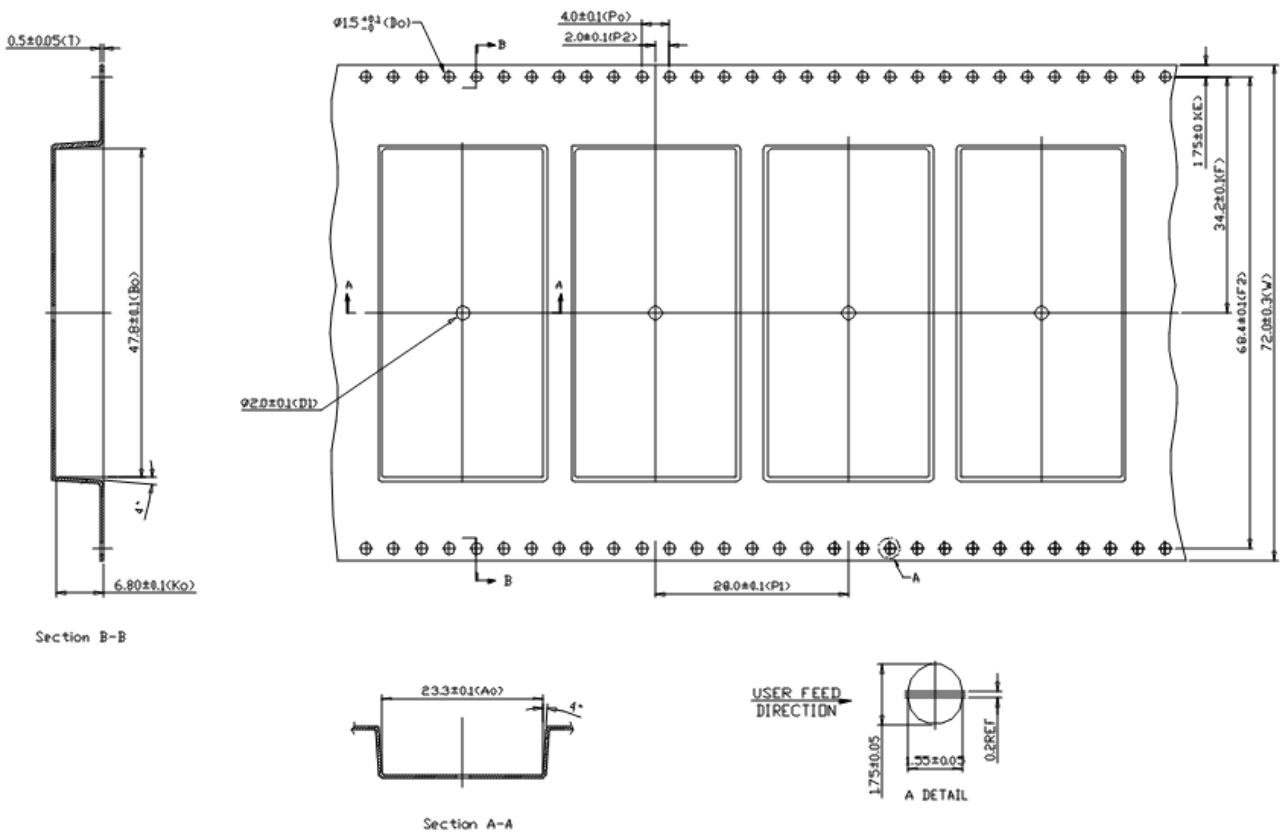

* Restrictions on Hazardous Substances, European Union Directive 2002/95/EC.

MA-COM Technology Solutions Inc. (MACOM) and its affiliates reserve the right to make changes to the product(s) or information contained herein without notice. Visit www.macomtech.com for additional data sheets and product information.

- **North America** Tel: 800.366.2266 / Fax: 978.366.2266
- **Europe** Tel: 44.1908.574.200 / Fax: 44.1908.574.300
- **Asia/Pacific** Tel: 81.44.844.8296 / Fax: 81.44.844.8298

MAFL-011018



MoCA Triplex Filter
5 - 42 / 54 - 1002 / 1125 - 1675 MHz

Rev. V7

Tray Information

Parameter	Units	Value
Min Order Qty	-	480
Tray Length	mm	270
Tray Width	mm	200
Height	mm	20.8
Ao	mm	40
Bo	mm	55
Ko	mm	7.2
Orientation	-	See below

Ordering Information

Part Number	Package
MAFL-011018-Tray	Tray

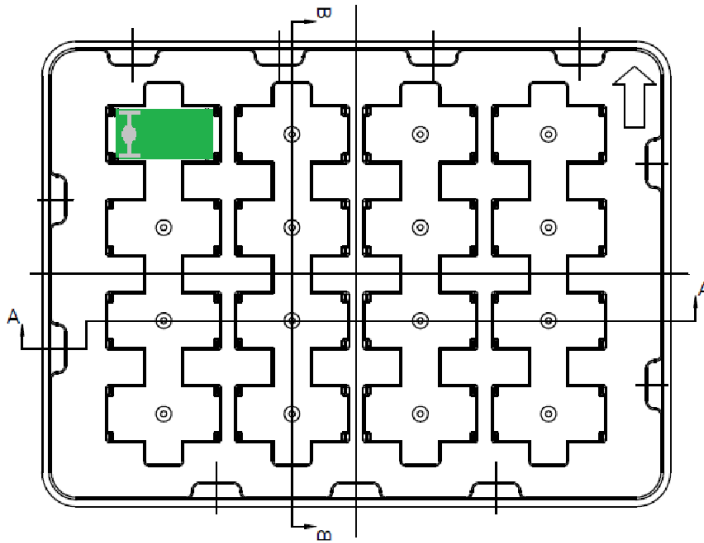

Section B-B

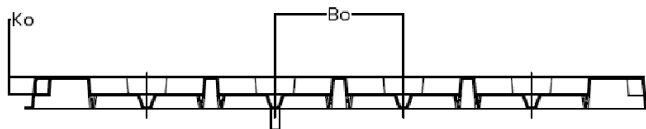

Section A-A

* Restrictions on Hazardous Substances, European Union Directive 2002/95/EC.