

# OS10040280GW

GaAs Optical Receiver  
40MHz to 1000MHz

The OS10040280GW is a hybrid high dynamic range optical receiver amplifier module. Two of the module pins are for connection to 24V (DC), one for amplifier supply voltage, the other for the PIN diode bias. The module contains a single mode optical input suitable for wavelengths from 1290nm to 1600nm, a terminal to monitor the PIN diode current, and an electrical output with an impedance of 75Ω.

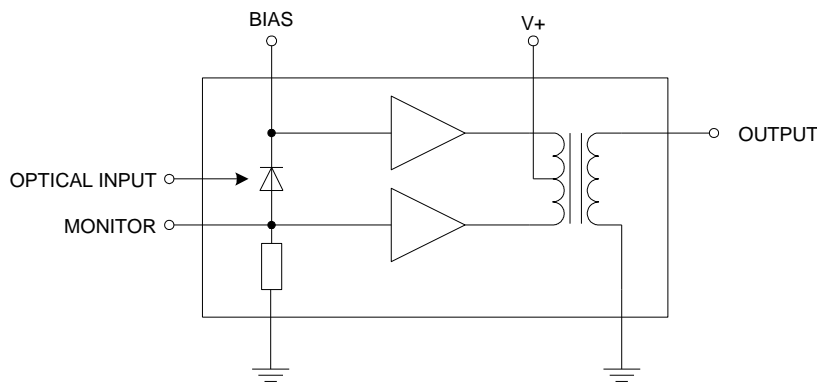

Package: SOT-115J

## Features

- Superior Return Loss Performance
- Extremely Low Distortion
- Optimal Reliability
- Low Noise
- Standard CATV Outline
- Excellent Flatness
- 255mA Max. at 24V+

## Applications

- 40MHz to 1000MHz CATV Amplifier Systems

## Ordering Information

OS10040280GW-012 Box with 3 Pieces

OS10040280GW-013 Box with 3 Pieces

OS10040280GW-014 Box with 3 Pieces

OS10040280GW-015 Box with 3 Pieces

OS10040280GW-016 Box with 3 Pieces

OS10040280GW-017 Box with 3 Pieces

See Page 3

## Absolute Maximum Ratings

Parameter	Rating	Unit
Frequency Range	40 to 1000	MHz
Optical Input Power (continuous)	5	mW
ESD Sensitivity (Human Body Model; R = 1.5k $\Omega$ , C = 100pF)	500	V
Storage Temperature	-40 to +85	$^{\circ}$ C
Operating Mounting Base Temperature	-20 to +85	$^{\circ}$ C
Minimum Fiber Bending Radius	35	mm
Maximum Tensile Strength	5	N



Caution! ESD sensitive device.



RoHS (Restriction of Hazardous Substances): Compliant per EU Directive 2011/65/EU.

Exceeding any one or a combination of the Absolute Maximum Rating conditions may cause permanent damage to the device. Extended application of Absolute Maximum Rating conditions to the device may reduce device reliability. Specified typical performance or functional operation of the device under Absolute Maximum Rating conditions is not implied.

## Nominal Operating Parameters

Parameter	Specification			Unit	Condition
	Min	Typ	Max		
<b>General Performance</b>					<b>V+ = 24V; T<sub>MB</sub> = 30<math>^{\circ}</math>C; Z<sub>L</sub> = 75<math>\Omega</math></b>
Responsivity	1700	1900	2100	V/W	f = 1000MHz, $\lambda$ = 1310nm
Slope Straight Line	0		2.0	dB	f = 40MHz to 1000MHz
Flatness Straight Line		0.7	1.0	dB	f = 40MHz to 1000MHz
Optical Input Return Loss	45.0			dB	
Output Return Loss	15.0	17.0		dB	f = 40MHz to 1000MHz
Equivalent Input Noise			7.5	pA/ $\sqrt$ Hz	f = 40MHz to 1000MHz
Spectral Sensitivity	0.85			A/W	$\lambda$ = (1310 $\pm$ 20)nm
	0.90			A/W	$\lambda$ = (1550 $\pm$ 20)nm
Optical Wavelength	1290		1600	nm	
Total Current Consumption (DC)		245	255	mA	Total current into hybrid with both pins 4 and 5 connected to V+ = 24V
PIN Diode Bias Current			10.0	mA	
<b>Distortion Data</b>					<b>V+ = 24V; T<sub>MB</sub> = 30<math>^{\circ}</math>C; Z<sub>L</sub> = 75<math>\Omega</math></b>
Second Order Distortion <sup>[1]</sup>		-74.0	-72.0	dBc	f <sub>m</sub> = 54MHz; f <sub>1</sub> = 187.25MHz; f <sub>2</sub> = 133.25MHz
		-70.0	-68.0	dBc	f <sub>m</sub> = 446.5MHz; f <sub>1</sub> = 97.25MHz; f <sub>2</sub> = 349.25MHz
		-70.0	-67.0	dBc	f <sub>m</sub> = 548.5MHz; f <sub>1</sub> = 109.25MHz; f <sub>2</sub> = 439.25MHz
		-66.0	-63.0	dBc	f <sub>m</sub> = 746.5MHz; f <sub>1</sub> = 133.25MHz; f <sub>2</sub> = 613.25MHz
		-65.0	-62.0	dBc	f <sub>m</sub> = 854.5MHz; f <sub>1</sub> = 133.25MHz; f <sub>2</sub> = 721.25MHz
Third Order Distortion <sup>[2]</sup>		-80.0	-78.0	dBc	f <sub>m</sub> = 55.25MHz; f <sub>1</sub> = 109.25MHz; f <sub>2</sub> = 133.25MHz; f <sub>3</sub> = 187.25MHz
		-82.0	-80.0	dBc	f <sub>m</sub> = 445.25MHz; f <sub>1</sub> = 193.25MHz; f <sub>2</sub> = 349.25MHz; f <sub>3</sub> = 97.25MHz.
		-82.0	-80.0	dBc	f <sub>m</sub> = 547.25MHz; f <sub>1</sub> = 217.25MHz; f <sub>2</sub> = 439.25MHz; f <sub>3</sub> = 109.25MHz
		-80.0	-78.0	dBc	f <sub>m</sub> = 745.25MHz; f <sub>1</sub> = 133.25MHz; f <sub>2</sub> = 265.25MHz; f <sub>3</sub> = 613.25MHz
		-78.0	-76.0	dBc	f <sub>m</sub> = 853.25MHz; f <sub>1</sub> = 133.25MHz; f <sub>2</sub> = 265.25MHz; f <sub>3</sub> = 721.25MHz

- Two laser test; each laser with 40% OMI; P<sub>opt</sub> = 1mW (total).
- Three laser test; each laser with 60% OMI; P<sub>opt</sub> = 1mW (total).

RF Micro Devices Inc. 7628 Thorndike Road, Greensboro, NC 27409-9421

DS140310

For sales or technical support, contact RFMD at +1.336.678.5570 or [customerservice@rfmd.com](mailto:customerservice@rfmd.com).

The information in this publication is believed to be accurate. However, no responsibility is assumed by RF Micro Devices, Inc. ("RFMD") for its use, nor for any infringement of patents or other rights of third parties resulting from its use. No license is granted by implication or otherwise under any patent or patent rights of RFMD. RFMD reserves the right to change component circuitry, recommended application circuitry and specifications at any time without prior notice.

### Cable Lengths and Connector Types

Tab	Dimension A				Optical Connector Type
	Inches	Tolerance	mm	Tolerance	
-012	33.4	-4 to +0.5	848	-102 to +13	FC/APC
-013	33.4	-4 to +0.5	848	-102 to +13	SC/APC
-014	37.5	-3.5 to +0.5	952	-89 to +13	FC/APC
-015	37.5	-3.5 to +0.5	952	-89 to +13	SC/APC
-016	21.1	-1.5 to +0.5	536	-38 to +13	FC/APC
-017	21.1	-1.5 to +0.5	536	-38 to +13	SC/APC

### Cable Lengths and Connector Types (continued)

Tab	Dimension B	
	Inches	mm
-012	No outer jacket	
-013	No outer jacket	
-014	0.315 to 0.710	8.0 to 18.0
-015	0.315 to 0.710	8.0 to 18.0
-016	0.315 to 0.710	8.0 to 18.0
-017	0.315 to 0.710	8.0 to 18.0

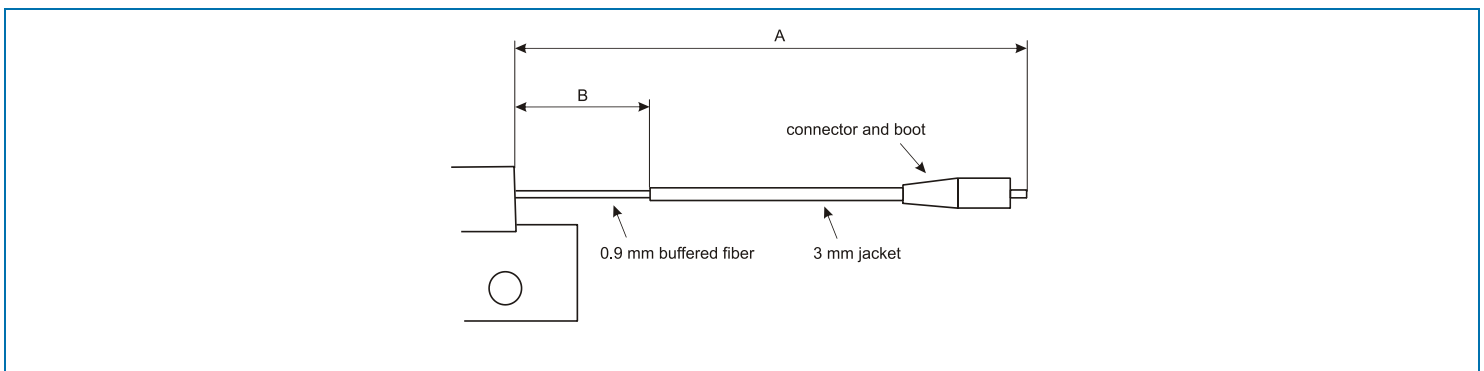
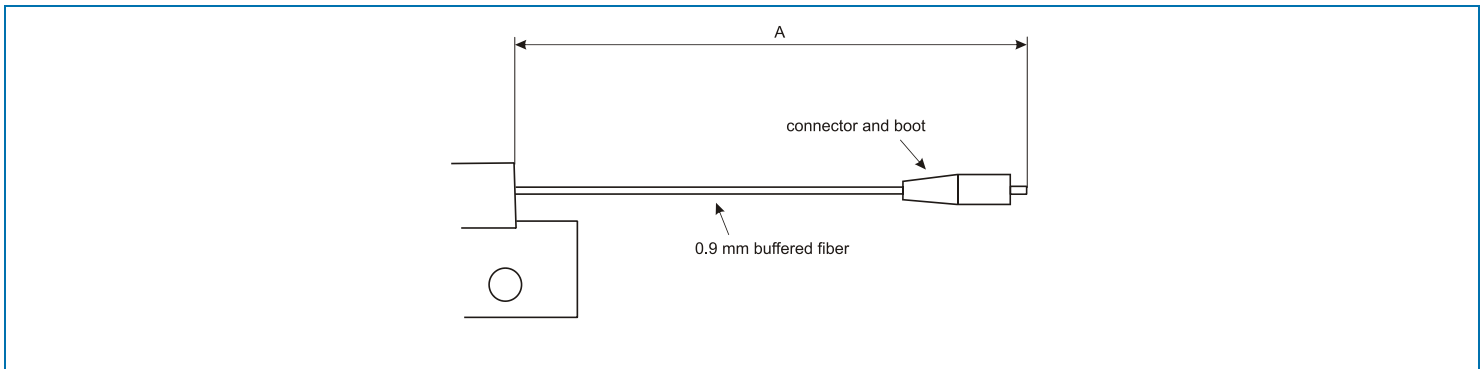

Package Drawing (Dimensions in millimeters)

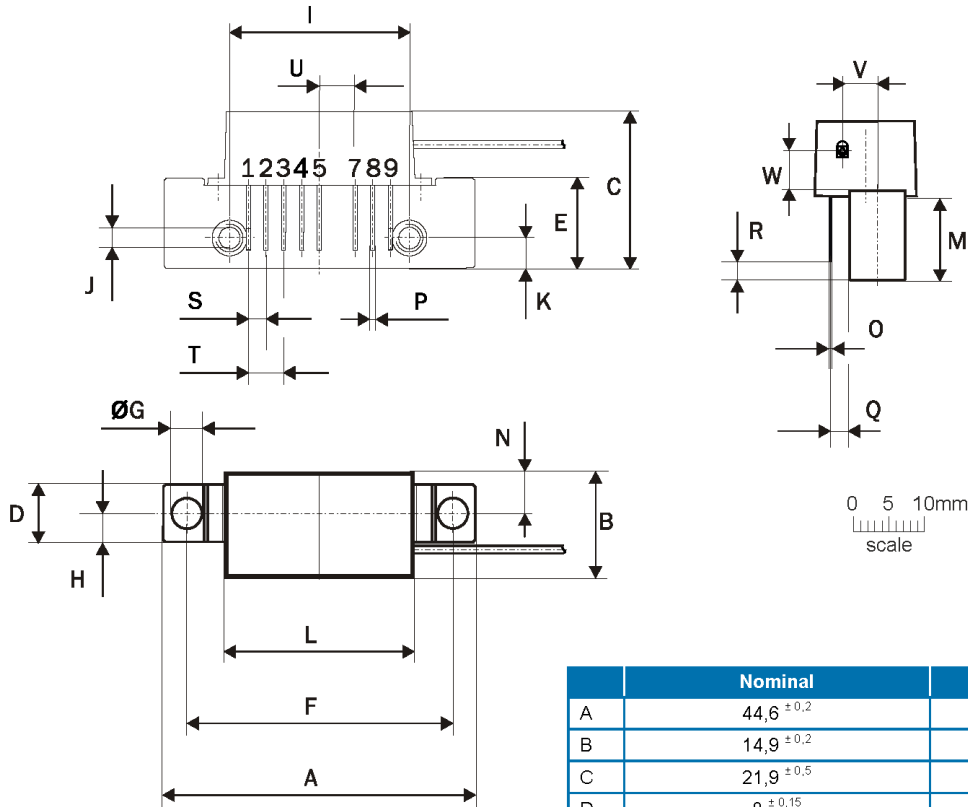

Notes:

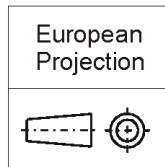

Pinning:

Pin	Name
1	PHOTODIODE CURRENT MONITOR
2-3	GND
4	PHOTODIODE BIAS
5	V+
6	
7-8	GND
9	OUTPUT

	Nominal	Min	Max
A	44,6 ±0,2	44,4	44,8
B	14,9 ±0,2	14,7	15,1
C	21,9 ±0,5	21,4	22,4
D	8 ±0,15	7,85	8,15
E	12,6 ±0,15	12,45	12,75
F	38,1 ±0,2	38,0	38,2
G	4 +0,2/-0,05	3,95	4,2
H	4 ±0,2	3,8	4,2
I	25,4 ±0,2	25,2	25,6
J	UNC 6-32	-	-
K	4,2 ±0,2	4,0	4,4
L	28,7 ±0,2	28,5	28,9
M	11,6 ±0,5	11,1	12,1
N	5,8 ±0,4	5,4	6,2
O	0,25 ±0,02	0,23	0,27
P	0,45 ±0,03	0,42	0,48
Q	2,54 ±0,3	2,24	2,84
R	2,54 ±0,5	2,04	3,04
S	2,54 ±0,25	2,29	2,79
T	5,08 ±0,25	4,83	5,33
U	5,08 ±0,25	4,83	5,33
V	5,0 ±0,2	4,8	5,2
W	5,35		