

R88M-K□, R88M-KH□

# Accurax G5 servo motors

**Servo family for accurate motion control.  
Power range extended up to 15 kW.**

- Standard and high inertia servo motor models
- Peak torque 300% of rated torque during 3 seconds or more depending on model
- High resolution serial encoder provided by 20 bits encoder
- IP67 protection in all models
- Ultra-light and compact size motor
- Low speed ripple and low torque ripple due to low torque cogging
- Various shaft, brake and seal options

**Ratings**

- 230 VAC from 50 W to 1.5 kW (rated torque from 0.16 to 8.59 Nm)
- 400 VAC from 400 W to 15 kW (rated torque from 1.91 Nm to 95.5 Nm)



## System configuration

(Refer to servo drive chapter)

Servo drive options

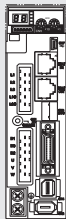

**Accurax G5 servo drives**  
EtherCAT, ML2 and  
Analogue/pulse models



**Standard servo motors**

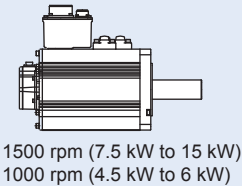
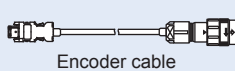
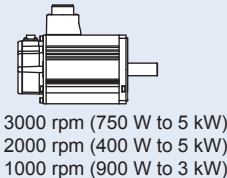

**High inertia servo motors**

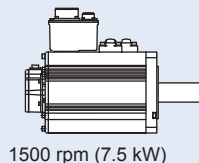
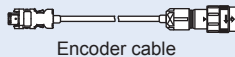
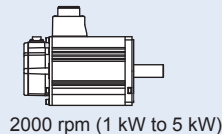
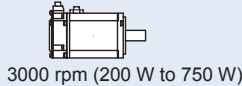

Servo motor / servo drive combination

Standard servo motors

Accurax G5 rotary servo motor						Accurax G5 servo drive models					
	Voltage	Speed	Rated torque	Capacity	Model	EtherCAT	Analog/pulse	MECHATROLINK-II			
	230 V	3000 min <sup>-1</sup>	0.16 Nm	50 W	R88M-K05030(H/T)-□	R88D-KN01H-ECT	R88D-KT01H	R88D-KN01H-ML2			
			0.32 Nm	100 W	R88M-K10030(H/T)-□	R88D-KN01H-ECT	R88D-KT01H	R88D-KN01H-ML2			
			0.64 Nm	200 W	R88M-K20030(H/T)-□	R88D-KN02H-ECT	R88D-KT02H	R88D-KN02H-ML2			
			1.3 Nm	400 W	R88M-K40030(H/T)-□	R88D-KN04H-ECT	R88D-KT04H	R88D-KN04H-ML2			
			2.4 Nm	750 W	R88M-K75030(H/T)-□	R88D-KN08H-ECT	R88D-KT08H	R88D-KN08H-ML2			
			3.18 Nm	1000 W	R88M-K1K030(H/T)-□	R88D-KN15H-ECT	R88D-KT15H	R88D-KN15H-ML2			
			4.77 Nm	1500 W	R88M-K1K530(H/T)-□	R88D-KN15H-ECT	R88D-KT15H	R88D-KN15H-ML2			
 230 V (1 kW to 1.5 kW) 400 V (400 W to 5 kW)	400 V	3000 min <sup>-1</sup>	2.39 Nm	750 W	R88M-K75030(F/C)-□	R88D-KN10F-ECT	R88D-KT10F	R88D-KN10F-ML2			
			3.18 Nm	1000 W	R88M-K1K030(F/C)-□	R88D-KN15F-ECT	R88D-KT15F	R88D-KN15F-ML2			
			4.77 Nm	1500 W	R88M-K1K530(F/C)-□	R88D-KN15F-ECT	R88D-KT15F	R88D-KN15F-ML2			
			6.37 Nm	2000 W	R88M-K2K030(F/C)-□	R88D-KN20F-ECT	R88D-KT20F	R88D-KN20F-ML2			
			9.55 Nm	3000 W	R88M-K3K030(F/C)-□	R88D-KN30F-ECT	R88D-KT30F	R88D-KN30F-ML2			
			12.7 Nm	4000 W	R88M-K4K030(F/C)-□	R88D-KN50F-ECT	R88D-KT50F	R88D-KN50F-ML2			
			15.9 Nm	5000 W	R88M-K5K030(F/C)-□	R88D-KN50F-ECT	R88D-KT50F	R88D-KN50F-ML2			
			 7.5 KW to 15 KW	230 V	2000 min <sup>-1</sup>	4.77 Nm	1000 W	R88M-K1K020(H/T)-□	R88D-KN10H-ECT	R88D-KT10H	R88D-KN10H-ML2
						7.16 Nm	1500 W	R88M-K1K520(H/T)-□	R88D-KN15H-ECT	R88D-KT15H	R88D-KN15H-ML2
						1.91 Nm	400 W	R88M-K40020(F/C)-□	R88D-KN06F-ECT	R88D-KT06F	R88D-KN06F-ML2
2.86 Nm	600 W	R88M-K60020(F/C)-□				R88D-KN06F-ECT	R88D-KT06F	R88D-KN06F-ML2			
4.77 Nm	1000 W	R88M-K1K020(F/C)-□				R88D-KN10F-ECT	R88D-KT10F	R88D-KN10F-ML2			
7.16 Nm	1500 W	R88M-K1K520(F/C)-□				R88D-KN15F-ECT	R88D-KT15F	R88D-KN15F-ML2			
9.55 Nm	2000 W	R88M-K2K020(F/C)-□				R88D-KN20F-ECT	R88D-KT20F	R88D-KN20F-ML2			
400 V	1500 min <sup>-1</sup>	14.3 Nm	3000 W	R88M-K3K020(F/C)-□	R88D-KN30F-ECT	R88D-KT30F	R88D-KN30F-ML2				
		19.1 Nm	4000 W	R88M-K4K020(F/C)-□	R88D-KN50F-ECT	R88D-KT50F	R88D-KN50F-ML2				
		23.9 Nm	5000 W	R88M-K5K020(F/C)-□	R88D-KN50F-ECT	R88D-KT50F	R88D-KN50F-ML2				
		47.8 Nm	7500 W	R88M-K7K515C-□	R88D-KN75F-ECT	R88D-KT75F	-				
	230 V 400 V	1000 min <sup>-1</sup>	70.0 Nm	11000 W	R88M-K11K015C-□	R88D-KN150F-ECT	R88D-KT150F	-			
			95.5 Nm	15000 W	R88M-K15K015C-□	R88D-KN150F-ECT	R88D-KT150F	-			
			8.59 Nm	900 W	R88M-K90010(H/T)-□	R88D-KN15H-ECT	R88D-KT15H	R88D-KN15H-ML2			
			8.59 Nm	900 W	R88M-K90010(F/C)-□	R88D-KN15F-ECT	R88D-KT15F	R88D-KN15F-ML2			
			19.1 Nm	2000 W	R88M-K2K010(F/C)-□	R88D-KN30F-ECT	R88D-KT30F	R88D-KN30F-ML2			
			28.7 Nm	3000 W	R88M-K3K010(F/C)-□	R88D-KN50F-ECT	R88D-KT50F	R88D-KN50F-ML2			
			43.0 Nm	4500 W	R88M-K4K510C-□	R88D-KN50F-ECT	R88D-KT50F	R88D-KN50F-ML2			
			57.3 Nm	6000 W	R88M-K6K010C-□	R88D-KN75F-ECT	R88D-KT75F	-			

High inertia servo motors

Accurax G5 rotary servo motor						Accurax G5 servo drive models		
	Voltage	Speed	Rated torque	Capacity	Model	EtherCAT	Analog/pulse	MECHATROLINK-II
	230 V	3000 min <sup>-1</sup>	0.64 Nm	200 W	R88M-KH20030(H/T)-□	R88D-KN02H-ECT	R88D-KT02H	R88D-KN02H-ML2
			1.3 Nm	400 W	R88M-KH40030(H/T)-□	R88D-KN04H-ECT	R88D-KT04H	R88D-KN04H-ML2
			2.4 Nm	750 W	R88M-KH75030(H/T)-□	R88D-KN08H-ECT	R88D-KT08H	R88D-KN08H-ML2
 1 kW to 5 kW	400 V	2000 min <sup>-1</sup>	4.77 Nm	1000 W	R88M-KH1K020(F/C)-□	R88D-KN10F-ECT	R88D-KT10F	R88D-KN10F-ML2
			7.16 Nm	1500 W	R88M-KH1K520(F/C)-□	R88D-KN15F-ECT	R88D-KT15F	R88D-KN15F-ML2
			9.55 Nm	2000 W	R88M-KH2K020(F/C)-□	R88D-KN20F-ECT	R88D-KT20F	R88D-KN20F-ML2
			14.3 Nm	3000 W	R88M-KH3K020(F/C)-□	R88D-KN30F-ECT	R88D-KT30F	R88D-KN30F-ML2
			19.1 Nm	4000 W	R88M-KH4K020(F/C)-□	R88D-KN50F-ECT	R88D-KT50F	R88D-KN50F-ML2
			23.9 Nm	5000 W	R88M-KH5K020(F/C)-□	R88D-KN50F-ECT	R88D-KT50F	R88D-KN50F-ML2
 7.5 KW	400 V	1500 min <sup>-1</sup>	47.8 Nm	7500 W	R88M-KH7K515C-□	R88D-KN75F-ECT	R88D-KT75F	-

Note: 1. For servo motor and cables part numbers refer to ordering information at the end of this chapter  
 2. Refer to the servo drive chapter for drive options selection and detailed specifications

**Servo motor type designation**

**Standard servo motors**

**R88M-K05030H-BOS2**

Accurax G5 servomotor

Capacity

050	50 W
100	100 W
200	200 W
400	400 W
600	600 W
750	750 W
900	900 W
1K0	1 kW
1K5	1.5 kW
2K0	2 kW
3K0	3 kW
4K0	4 kW
4K5	4.5 kW
5K0	5 kW
6K0	6 kW
7K5	7.5 kW
11K0	11 kW
15K0	15 kW

Rated Speed (r/min)

10	1000
15	1500
20	2000
30	3000

Shaft end specifications

Blank	Straight shaft, no key
S2	Straight, key, tapped (standard)

Oil seal specifications

Blank	No oil seal
O	Oil seal

Brake specifications

Blank	No brake
B	Brake

Voltage and encoder specifications

- H: 230 V and 20-bit incremental encoder
- T: 230 V and 17-bit absolute encoder
- F: 400 V and 20-bit incremental encoder
- C: 400 V and 17-bit absolute encoder

**High inertia servo motors**

**R88M-KH1K020F-BS1-D**

Accurax G5 high inertia servomotor

Capacity

200	200 W
400	400 W
750	750 W
1K0	1 kW
1K5	1.5 kW
2K0	2 kW
3K0	3 kW
4K0	4 kW
5K0	5 kW
7K5	7.5 kW

Rated Speed (r/min)

15	1500
20	2000
30	3000

Circular connector (only for 230 V models)

Shaft end specifications

Blank	Straight shaft, no key
S1	400 V motor models - Shaft end with key (standard)
S2	230 V motor models - Straight, key, tapped (standard)

Brake specifications

Blank	No brake
B	Brake

Voltage and encoder specifications

- H: 230 V and 20-bit incremental encoder
- T: 230 V and 17-bit absolute encoder
- F: 400 V and 20-bit incremental encoder
- C: 400 V and 17-bit absolute encoder

Servo motor specifications

Standard servo motors 3000 r/min, 230 V

Ratings and specifications

Voltage		230 V							
Servo motor model R88M-K□	20-bit incremental encoder	05030H-□	10030H-□	20030H-□	40030H-□	75030H-□	1K030H-□	1K530H-□	
	17-bit absolute encoder	05030T-□	10030T-□	20030T-□	40030T-□	75030T-□	1K030T-□	1K530T-□	
Rated output	W	50	100	200	400	750	1000	1500	
Rated torque	N·m	0.16	0.32	0.64	1.3	2.4	3.18	4.77	
Instantaneous peak torque	N·m	0.48	0.95	1.91	3.8	7.1	9.55	14.3	
Rated current	A (rms)	1.1	1.1	1.5	2.4	4.1	6.6	8.2	
Instantaneous max. current	A (rms)	4.7	4.7	6.5	10.2	17.4	28	35	
Rated speed	min <sup>-1</sup>	3000							
Max. speed	min <sup>-1</sup>	6000						5000	
Torque constant	N·m/A	0.11±10%	0.21±10%	0.31±10%	0.39±10%	0.42±10%	0.37	0.45	
Rotor moment of inertia (JM)	kg·m <sup>2</sup> ×10 <sup>-4</sup> (without brake)	0.025	0.051	0.14	0.26	0.87	2.03	2.84	
	kg·m <sup>2</sup> ×10 <sup>-4</sup> (with brake)	0.027	0.054	0.16	0.28	0.97	2.35	3.17	
Allowable load moment of inertia (JL)	Multiple of (JM)	30 <sup>1</sup>				20 <sup>1</sup>		15 <sup>1</sup>	
Rated power rate	kW/s (without brake)	10.1	19.9	29.0	62.4	65.6	49.8	80.1	
	kW/s (with brake)	9.4	18.8	25.4	58	58.8	43	71.8	
Allowable radial load	N	68			245		490		
Allowable thrust load	N	58			98		196		
Approx. mass	kg (without brake)	0.32	0.47	0.82	1.2	2.3	3.5	4.4	
	kg (with brake)	0.53	0.68	1.3	1.7	3.1	4.5	5.4	
Brake specifications	Rated voltage	24 VDC ±10%							
	Holding brake moment of inertia J	kg·m <sup>2</sup> ×10 <sup>-4</sup> 0.002			0.0018		0.33		
	Power consumption (at 20°C)	W 7			9		17		19
	Current consumption (at 20°C)	A 0.3			0.36		0.70±10%		0.81±10%
	Static friction torque	N·m (minimum) 0.29			1.27		2.5		7.8
	Release time	ms (max.) 35					50		
Basic specifications	Time Rating	Continuous							
	Insulation class	Type B						Type F	
	Ambient operating/ storage temperature	0 to +40°C/-20 to 65°C							
	Ambient operating/ storage humidity	20% to 80% (non-condensing)					20% to 85% (non-condensing)		
	Vibration class	V-15							
	Insulation resistance	20 MΩ min. at 500 VDC between the power terminals and FG terminal							
	Enclosure	Totally-enclosed, self-cooling, IP67 (excluding shaft opening)							
	Vibration resistance	Vibration acceleration 49 m/s <sup>2</sup>							
Mounting	Flange-mounted								

<sup>1</sup> Applicable load inertia: The operable load inertia ratio (load inertia/rotor inertia) depends on the mechanical configuration and its rigidity. For a machine with high rigidity, operation is possible even with high load inertia. Select an appropriate motor and confirm that operation is possible.

Torque-speed characteristics

R88M-K05030H/T (50 W)



R88M-K10030H/T (100 W)



R88M-K20030H/T (200 W)



R88M-K40030H/T (400 W)

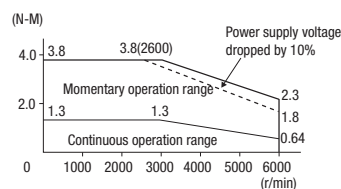

R88M-K75030H/T (750 W)

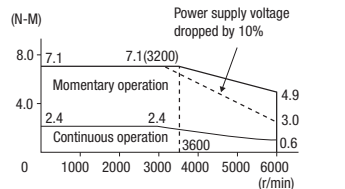

R88M-K1K030H/T (1 kW)

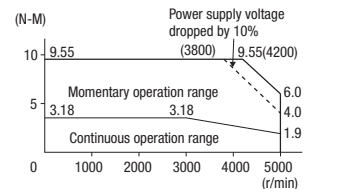

R88M-K1K530H/T (1.5 kW)

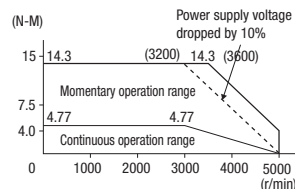

Standard servo motors 3000 r/min, 400 V

Ratings and specifications

Voltage		400 V							
Servo motor model R88M-K□	20-bit incremental encoder	75030F-□	1K030F-□	1K530F-□	2K030F-□	3K030F-□	4K030F-□	5K030F-□	
	17-bit absolute encoder	75030C-□	1K030C-□	1K530C-□	2K030C-□	3K030C-□	4K030C-□	5K030C-□	
Rated output	W	750	1000	1500	2000	3000	4000	5000	
Rated torque	N·m	2.39	3.18	4.77	6.37	9.55	12.7	15.9	
Instantaneous peak torque	N·m	7.16	9.55	14.3	19.1	28.6	38.2	47.7	
Rated current	A (rms)	2.4	3.3	4.2	5.7	9.2	9.9	12	
Instantaneous max. current	A (rms)	10	14	18	24	39	42	51	
Rated speed	min <sup>-1</sup>	3000							
Max. speed	min <sup>-1</sup>	5000					4500		
Torque constant	N·m/A	0.78	0.75	0.89	0.87	0.81	0.98		
Rotor moment of inertia (JM)	kg·m <sup>2</sup> ×10 <sup>-4</sup> (without brake)	1.61	2.03	2.84	3.68	6.5	12.9	17.4	
	kg·m <sup>2</sup> ×10 <sup>-4</sup> (with brake)	1.93	2.35	3.17	4.01	7.85	14.2	18.6	
Allowable load moment of inertia (JL)	Multiple of (JM)	20 <sup>1</sup>			15 <sup>1</sup>				
Rated power rate	kW/s (without brake)	35.5	49.8	80.1	110	140	126	146	
	kW/s (with brake)	29.6	43	71.8	101	116	114	136	
Allowable radial load	N	490				784			
Allowable thrust load	N	196				343			
Approx. mass	kg (without brake)	3.1	3.5	4.4	5.3	8.3	11	14	
	kg (with brake)	4.1	4.5	5.4	6.3	9.4	12.6	16	
Brake specifications	Rated voltage	24 VDC ±10%							
	Holding brake moment of inertia J	0.33						1.35	
	Power consumption (at 20°C)	W	17	19				22	
	Current consumption (at 20°C)	A	0.70±10%			0.81±10%		0.90±10%	
	Static friction torque	N·m (minimum)	2.5		7.8		11.8		16.1
	Rise time for holding torque	ms (max.)	50				110		
Release time	ms (max)	15				50			
Basic specifications	Time Rating	Continuous							
	Insulation class	Type F							
	Ambient operating/ storage temperature	0 to +40°C/-20 to 65°C							
	Ambient operating/ storage humidity	20% to 85% (non-condensing)							
	Vibration class	V-15							
	Insulation resistance	20 MΩ min. at 500 VDC between the power terminals and FG terminal							
	Enclosure	Totally-enclosed, self-cooling, IP67(excluding shaft opening)							
	Vibration resistance	Vibration acceleration 49 m/s <sup>2</sup>							
Mounting	Flange-mounted								

<sup>1</sup> Applicable load inertia: The operable load inertia ratio (load inertia/rotor inertia) depends on the mechanical configuration and its rigidity. For a machine with high rigidity, operation is possible even with high load inertia. Select an appropriate motor and confirm that operation is possible.

Torque-speed characteristics

R88M-K75030F/C (750 W)



R88M-K1K030F/C (1 kW)



R88M-K1K530F/C (1.5 kW)

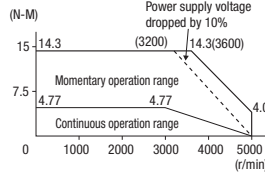

R88M-K2K030F/C (2 kW)



R88M-K3K030F/C (3 kW)



R88M-K4K030F/C (4 kW)



R88M-K5K030F/C (5 kW)



## Standard servo motors 2000 r/min, 230 V/400 V

### Ratings and specifications

Voltage		230 V					400 V				
Servo motor model R88M-K□	20-bit incremental encoder	1K020H-□	1K520H-□	40020F-□	60020F-□	1K020F-□	1K520F-□	2K020F-□	3K020F-□	4K020F-□	5K020F-□
	17-bit absolute encoder	1K020T-□	1K520T-□	40020C-□	60020C-□	1K020C-□	1K520C-□	2K020C-□	3K020C-□	4K020C-□	5K020C-□
Rated output	W	1000	1500	400	600	1000	1500	2000	3000	4000	5000
Rated torque	N·m	4.77	7.16	1.91	2.86	4.77	7.16	9.55	14.3	19.1	23.9
Instantaneous peak torque	N·m	14.3	21.5	5.73	8.59	14.3	21.5	28.7	43	57.3	71.6
Rated current	A (rms)	5.7	9.4	1.2	1.5	2.8	4.7	5.9	8.7	10.6	13
Instantaneous max. current	A (rms)	24	40	4.9	6.5	12	20	25	37	45	55
Rated speed	min <sup>-1</sup>	2000									
Max. speed	min <sup>-1</sup>	3000									
Torque constant	N·m/A	0.63	0.58	1.27	1.38	1.27	1.16	1.27	1.18	1.40	1.46
Rotor moment of inertia (JM)	kg·m <sup>2</sup> ×10 <sup>-4</sup> (without brake)	4.60	6.70	1.61	2.03	4.60	6.70	8.72	12.9	37.6	48
	kg·m <sup>2</sup> ×10 <sup>-4</sup> (with brake)	5.90	7.99	1.90	2.35	5.90	7.99	10	14.2	38.6	48.8
Max. load moment of inertia (JL)	Multiple of (JM)	10 <sup>1</sup>									
Rated power rate	kW/s (without brake)	49.5	76.5	22.7	40.3	49.5	76.5	105	159	97.1	119
	kW/s (with brake)	38.6	64.2	19.2	34.8	38.6	64.2	91.2	144	94.5	117
Allowable radial load	N	490					784				
Allowable thrust load	N	196					343				
Approx. mass	kg (without brake)	5.2	6.7	3.1	3.5	5.2	6.7	8	11	15.5	18.6
	kg (with brake)	6.7	8.2	4.1	4.5	6.7	8.2	9.5	12.6	18.7	21.8
Brake specifications	Rated voltage	24VDC ±10%									
	Holding brake moment inertia	(J) kg·m <sup>2</sup> ×10 <sup>-4</sup> 1.35									4.7
	Power consumption (20°C)	W	14	19	17	14	19	22	31		
	Current consumption (20°C)	A	0.59±10%	0.79±10%	0.70 ±10%	0.59±10%	0.79 ±10%	0.90±10%	1.3±10%	1.3 ±10%	
	Static friction torque	N·m (minimum)	4.9	13.7	2.5	4.9	13.7	16.2	24.5		
	Rise time for holding torque	ms (max.)	80	100	50	80	100	110	80		
Release time	ms (max)	70	50	15	70	50	25				
Basic specifications	Time Rating	Continuous									
	Insulation class	Type F									
	Ambient operating/ storage temperature	0 to +40°C/-20 to 65°C									
	Ambient operating/ storage humidity	20% to 85% (non-condensing)									
	Vibration class	V-15									
	Insulation resistance	20 MΩ min. at 500 VDC between the power terminals and FG terminal									
Enclosure	Totally-enclosed, self-cooling, IP67 (excluding shaft opening)										
Vibration resistance	Vibration acceleration 49 m/s <sup>2</sup>										
Mounting	Flange-mounted										

\*1. Applicable load inertia: The operable load inertia ratio (load inertia/rotor inertia) depends on the mechanical configuration and its rigidity. For a machine with high rigidity, operation is possible even with high load inertia. Select an appropriate motor and confirm that operation is possible.

### Torque-speed characteristics

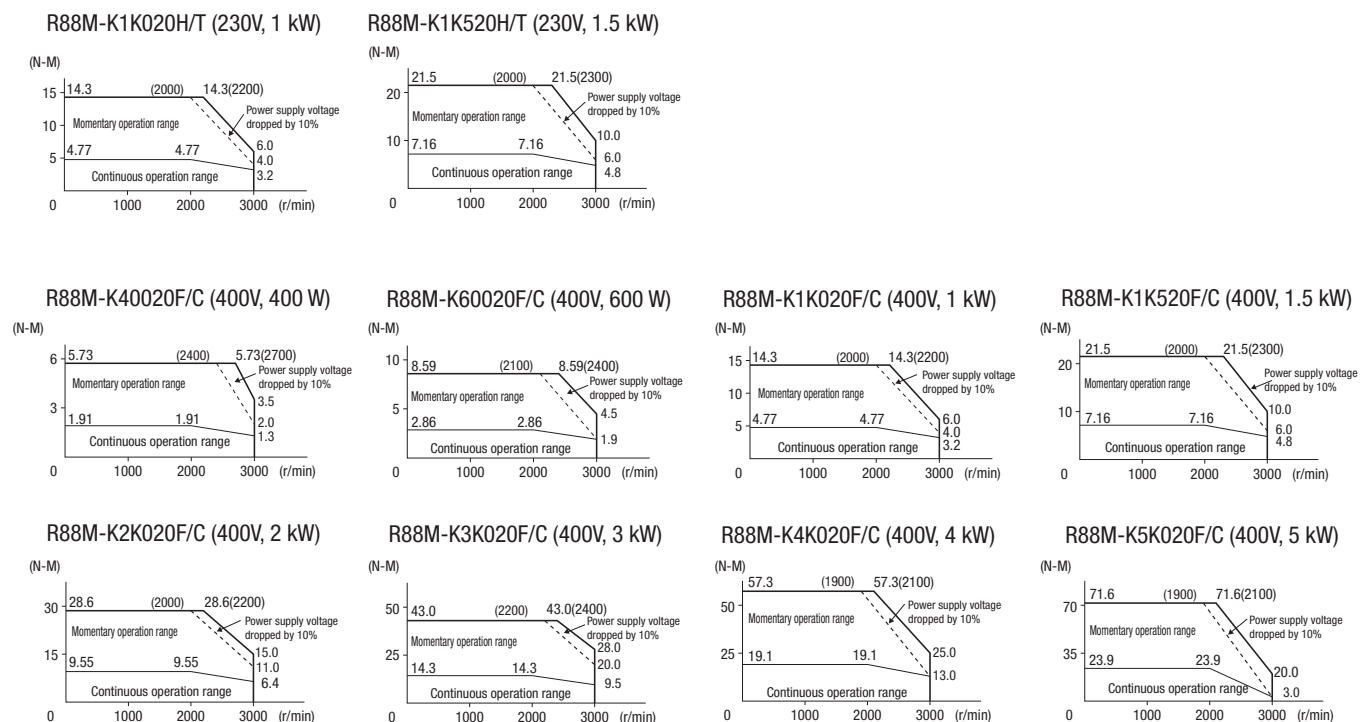

Standard servo motors 1500 r/min, 400 V

Ratings and specifications

Applied voltage		400 V		
Servo motor model R88M-K□	17-bit absolute encoder	7K515C-□	11K015C-□	15K015C-□
Rated output	W	7500	11000	15000
Rated torque	N·m	47.8	70.0	95.5
Instantaneous peak torque	N·m	119.0	175.0	224.0
Rated current	A (rms)	22.0	27.1	33.1
Instantaneous max. current	A (rms)	83	101	118
Rated speed	min <sup>-1</sup>	1500		
Max. speed	min <sup>-1</sup>	3000	2000	
Torque constant	N·m/A	1.54	1.84	2.10
Rotor moment of inertia (JM)	kg·m <sup>2</sup> ×10 <sup>-4</sup> (without brake)	101	212	302
	kg·m <sup>2</sup> ×10 <sup>-4</sup> (with brake)	107	220	311
Allowable load moment of inertia (JL)	Multiple of (JM)	10 <sup>-1</sup>		
Rated power rate	kW/s (without brake)	226	231	302
	kW/s (with brake)	213	223	293
Allowable radial load	N	1176	2254	
Allowable thrust load	N	490	686	
Approx. mass	kg (without brake)	36.4	52.7	70.2
	kg (with brake)	40.4	58.9	76.3
Brake specifications	Rated voltage	24VDC ±10%		
	Holding brake moment of inertia J	kg·m <sup>2</sup> ×10 <sup>-4</sup>	4.7	7.1
	Power consumption (at 20°C)	W	34	26
	Current consumption (at 20°C)	A	1.4±10%	1.08±10%
	Static friction torque	N·m (minimum)	58.8	100
	Release time	ms (max)	50	140
Basic specifications	Time Rating	Continuous		
	Insulation class	Type F		
	Ambient operating/ storage temperature	0 to +40°C/-20 to 65°C		
	Ambient operating/ storage humidity	20% to 85% RH (non-condensing)		
	Vibration class	V-15		
	Insulation resistance	20 MΩ min. at 500 VDC between the power terminals and FG terminal		
	Enclosure	Totally-enclosed, self-cooling, IP67 (excluding shaft opening)		
	Mounting	Flange-mounted		

\*1 Applicable load inertia: The operable load inertia ratio (load inertia/rotor inertia) depends on the mechanical configuration and its rigidity. For a machine with high rigidity, operation is possible even with high load inertia. Select an appropriate motor and confirm that operation is possible.

Torque-speed characteristics



## Standard servo motors 1000 r/min, 230 V/400 V

### Ratings and specifications

Applied voltage		230 V		400 V			
Servo motor model R88M-K□	20-bit incremental encoder	90010H-□	90010F-□	2K010F-□	3K010F-□		
	17-bit absolute encoder	90010T-□	90010C-□	2K010C-□	3K010C-□	4K510C-□	6K010C-□
Rated output	W	900	900	2000	3000	4500	6000
Rated torque	N·m	8.59		19.1	28.7	43.0	57.3
Instantaneous peak torque	N·m	19.3		47.7	71.7	107.0	143.0
Rated current	A (rms)	7.6	3.8	8.5	11.3	14.8	19.4
Instantaneous max. current	A (rms)	24	12	30	40	55	74
Rated speed	min <sup>-1</sup>	1000					
Max. speed	min <sup>-1</sup>	2000					
Torque constant	N·m/A	0.86	1.72	1.76	1.92	2.05	2.08
Rotor moment of inertia (JM)	kg·m <sup>2</sup> ×10 <sup>-4</sup> (without brake)	6.70		30.3	48.4	79.1	101
	kg·m <sup>2</sup> ×10 <sup>-4</sup> (with brake)	7.99		31.4	49.2	84.4	107
Allowable load moment of inertia (JL)	Multiple of (JM)	10 <sup>1</sup>					
Rated power rate	kW/s (without brake)	110		120	170	233	325
	kW/s (with brake)	92.4		116	167	219	307
Allowable radial load	N	686		1176	1470		1764
Allowable thrust load	N	196		490			588
Approx. mass	kg (without brake)	6.7		14	20	29.4	36.4
	kg (with brake)	8.2		17.5	23.5	33.3	40.4
Brake specifications	Rated voltage	24VDC ±10%					
	Holding brake moment of inertia J	kg·m <sup>2</sup> ×10 <sup>-4</sup>		4.7			
	Power consumption (at 20°C)	W	19		31	34	
	Current consumption (at 20°C)	A	0.79±10%		1.3±10%	1.4±10%	
	Static friction torque	N·m (minimum)	13.7		24.5	58.8	
	Rise time for holding torque	ms (max.)	100		80	150	
	Release time	ms (max)	50		25	50	
Basic specifications	Time Rating	Continuous					
	Insulation class	Type F					
	Ambient operating/ storage temperature	0 to +40°C/-20 to 65°C					
	Ambient operating/ storage humidity	20% to 85% RH (non-condensing)					
	Vibration class	V-15					
	Insulation resistance	20 MΩ min. at 500 VDC between the power terminals and FG terminal					
	Enclosure	Totally-enclosed, self-cooling, IP67 (excluding shaft opening)					
Vibration resistance	Vibration acceleration 49 m/s <sup>2</sup>						
Mounting	Flange-mounted						

\*1 Applicable load inertia: The operable load inertia ratio (load inertia/rotor inertia) depends on the mechanical configuration and its rigidity. For a machine with high rigidity, operation is possible even with high load inertia. Select an appropriate motor and confirm that operation is possible.

### Torque-speed characteristics

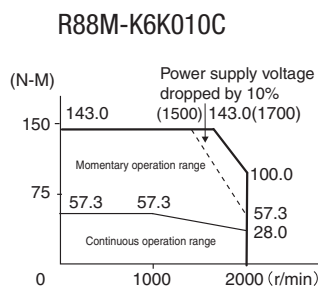
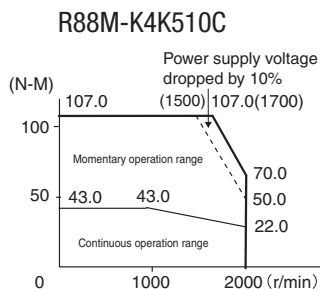
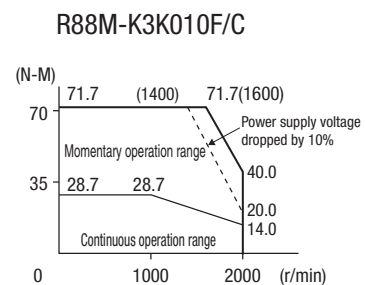
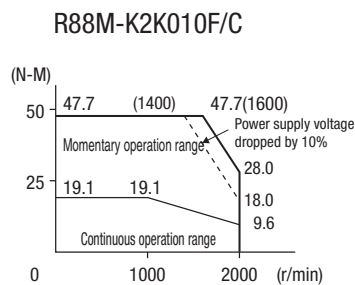
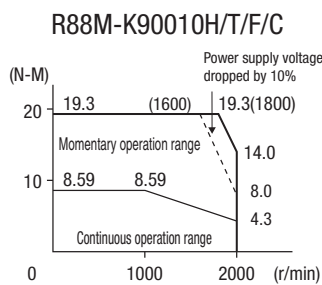



High inertia servo motors 3000 r/min, 230 V

Ratings and specifications

Voltage		230 V		
Servo motor model R88M-KH□	20-bit incremental encoder	20030H-□	40030H-□	75030H-□
	17-bit absolute encoder	20030T-□	40030T-□	75030T-□
Rated output	W	200	400	750
Rated torque	N·m	0.64	1.3	2.4
Instantaneous peak torque	N·m	1.91	3.8	7.1
Rated current	A (rms)	1.6	2.6	4.0
Instantaneous max. current	A (rms)	6.9	11.0	17.0
Rated speed	min <sup>-1</sup>	3000		
Max. speed	min <sup>-1</sup>	5000		4500
Torque constant	N·m/A	0.29±10%	0.36±10%	0.45±10%
Rotor moment of inertia (JM)	kg·m <sup>2</sup> ×10 <sup>-4</sup> (without brake)	0.42	0.67	1.51
	kg·m <sup>2</sup> ×10 <sup>-4</sup> (with brake)	0.45	0.70	1.61
Allowable load moment of inertia (JL)	Multiple of (JM)	30 <sup>-1</sup>		20 <sup>-1</sup>
Rated power rate	kW/s (without brake)	9.58	24.1	37.7
	kW/s (with brake)	9.06	23.3	35.3
Allowable radial load	N	245		392
Allowable thrust load	N	98		147
Approx. mass	kg (without brake)	0.96	1.4	2.5
	kg (with brake)	1.4	1.8	3.3
Brake specifications	Rated voltage	24 VDC ±5%		
	Holding brake moment of inertia J	kg·m <sup>2</sup> ×10 <sup>-4</sup>	0.018	0.075
	Power consumption (at 20°C)	W	9	10
	Current consumption (at 20°C)	A	0.36	0.42
	Static friction torque	N·m (minimum)	1.27	2.45
	Release time	ms (max)	15	20
Basic specifications	Time Rating	Continuous		
	Insulation class	Type B		
	Ambient operating/ storage temperature	0 to +40°C/-20 to 65°C		
	Ambient operating/ storage humidity	20% to 85% RH (non-condensing)		
	Vibration class	V-15		
	Insulation resistance	20 MΩ min. at 500 VDC between the power terminals and FG terminal		
	Enclosure	Totally-enclosed, self-cooling, IP65 (excluding shaft opening and lead wire ends)		
Vibration resistance	Vibration acceleration 49 m/s <sup>2</sup>			
Mounting	Flange-mounted			

\*1 Applicable load inertia: The operable load inertia ratio (load inertia/rotor inertia) depends on the mechanical configuration and its rigidity. For a machine with high rigidity, operation is possible even with high load inertia. Select an appropriate motor and confirm that operation is possible.

Torque-speed characteristics

R88M-KH20030H/T (230 V, 200 W)

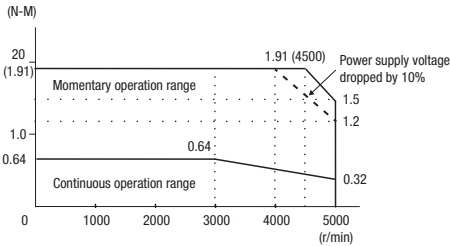

R88M-KH40030H/T (230 V, 400 W)

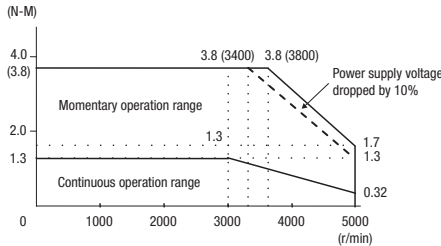

R88M-KH75030H/T (230 V, 750 W)

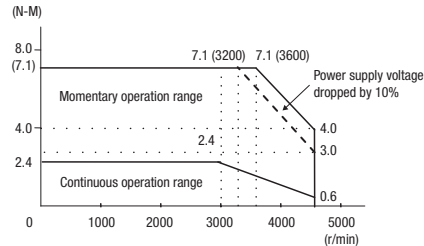

## High inertia servo motors 2000 and 1500 r/min, 400 V

### Ratings and specifications

R/min, Voltage		2000 r/min, 400 V						1500 r/min, 400 V
Servo motor model R88M-KH□	20-bit incremental encoder	1K020F-□	1K520F-□	2K020F-□	3K020F-□	4K020F-□	5K020F-□	
	17-bit absolute encoder	1K020C-□	1K520C-□	2K020C-□	3K020C-□	4K020C-□	5K020C-□	7K515C-□
Rated output	W	1000	1500	2000	3000	4000	5000	7500
Rated torque	N·m	4.77	7.16	9.55	14.3	19.1	23.9	47.8
Instantaneous peak torque	N·m	14.3	21.5	28.6	43.0	57.3	71.6	119
Rated current	A (rms)	2.9	4.7	5.5	8.0	10.5	13.0	22.0
Instantaneous max. current	A (rms)	12	20	24	34	45	55	83
Rated speed	min <sup>-1</sup>	2000						1500
Max. speed	min <sup>-1</sup>	3000						3000
Torque constant	N·m/A	1.27	1.16	1.31	1.34	1.38	1.39	1.54
Rotor moment of inertia (JM)	kg·m <sup>2</sup> ×10 <sup>-4</sup> (without brake)	24.7	37.1	57.8	90.2	112	162	273
	kg·m <sup>2</sup> ×10 <sup>-4</sup> (with brake)	26.0	38.4	62.9	95.3	117	167	279
Max. load moment of inertia (JL)	Multiple of (JM)	5 <sup>*1</sup>						
Rated power rate	kW/s (without brake)	9.2	13.8	15.8	22.7	32.5	35.1	86.7
	kW/s (with brake)	8.8	13.4	14.5	21.5	31.1	34.1	85.1
Allowable radial load	N	490			784			1176
Allowable thrust load	N	196			343			490
Approx. mass	kg (without brake)	6.7	8.6	12.2	16.0	18.6	23.0	42.3
	kg (with brake)	8.1	10.1	15.5	19.2	21.8	26.2	46.2
Rated voltage		24 VDC ±10%						
Brake specifications	Holding brake moment inertia (J) kg·m <sup>2</sup> ×10 <sup>-4</sup>	1.35			4.7			
	Power consumption (20°C) W	14	19	31				34
	Current consumption (20°C) A	0.59±10%	0.79±10%	1.30±10%				1.40±10%
	Static friction torque N·m (minimum)	4.9	13.7	24.5				58.8
	Rise time for holding torque ms (max.)	80	100	80				150
	Release time ms (max)	70	50	25				50
	Time Rating	Continuous						
Basic specifications	Insulation class	Type F						
	Ambient operating/ storage temperature	0 to +40°C/-20 to 65°C						
	Ambient operating/ storage humidity	20% to 85% RH (non-condensing)						
	Vibration class	V-15						
	Insulation resistance	20 MΩ min. at 500 VDC between the power terminals and FG terminal						
	Enclosure	Totally-enclosed, self-cooling, IP67 (excluding shaft opening)						
	Vibration resistance	Vibration acceleration 49 m/s <sup>2</sup>						
Mounting	Flange-mounted							

\*1 Applicable load inertia: The operable load inertia ratio (load inertia/rotor inertia) depends on the mechanical configuration and its rigidity. For a machine with high rigidity, operation is possible even with high load inertia. Select an appropriate motor and confirm that operation is possible.

### Torque-speed characteristics

R88M-KH1K020F/C (400 V, 1 kW)

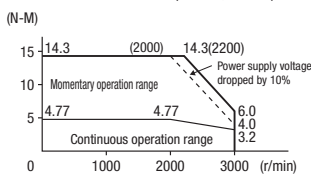

R88M-KH1K520F/C (400 V, 1.5 kW)



R88M-KH2K020F/C (400 V, 2 kW)

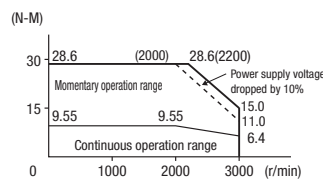

R88M-KH3K020F/C (400 V, 3 kW)

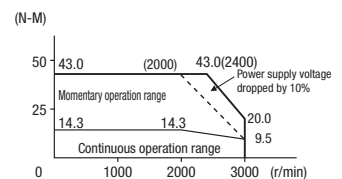

R88M-KH4K020F/C (400 V, 4 kW)

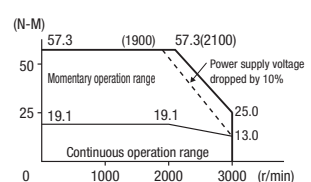

R88M-KH5K020F/C (400 V, 5 kW)

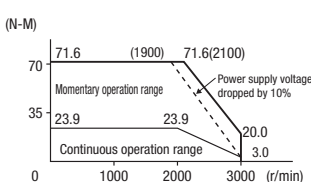

R88M-KH7K515C (7.5 kW)



**Dimensions**

**Standard servo motors**

**Type 3000 r/min motors (230 V, 50 to 100 W)**

Dimensions (mm)	Without brake		With brake		LN	Shaft end dimensions	Approx. mass (kg)	
	LL	LM	LL	LM			Without brake	With brake
Model						Tap × Depth		
R88M-K05030(H/T)-□S2	72	48	102	78	23	M3 × 6L	0.32	0.53
R88M-K10030(H/T)-□S2	92	68	122	98	43		0.47	0.68



**Type 3000 r/min motors (230 V, 200 to 750 W)**

Dimensions (mm)	Without brake			With brake			LR	Flange surface						Shaft end dimensions						Approx. mass kg		
	LL	LM	KL1	LL	LM	KL1		LB	LC	LD	LE	LG	LZ	S	K	QK	H	B	T	Tap × Depth	Without brake	With brake
Model																						
R88M-K20030(H/T)-□S2	79.5	56.5	52.5	116	93	52.5	30	50 <sup>H7</sup>	60	70	3	6.5	4.5	11 <sup>H6</sup>	20	18	8.5	4 <sup>H9</sup>	4	M4 × 8L	0.82	1.3
R88M-K40030(H/T)-□S2	99	76	52.5	135.5	112.5	52.5								14 <sup>H6</sup>	25	22.5	11	5 <sup>H9</sup>	5	M5 ×	1.2	1.7
R88M-K75030(H/T)-□S2	112.2	86.2	60	148.2	122.2	61.6	35	70 <sup>H7</sup>	80	90		8	6	19 <sup>H6</sup>		22	15.5	6 <sup>H9</sup>	6	10L	2.3	3.1



**Type 3000 r/min motors (230 V, 1 to 1.5 kW/400V, 750 W to 5 kW)**

Voltage	Model	Without brake					With brake					LR	Flange surface						Shaft end dimensions						Approx. Mass (kg)		
		LL	LM	KB1	KB2	KL1	LL	LM	KB1	KB2	KL1		LA	LB	LC	LD	LE	LG	S	Tap × Depth	K	QK	H	B	T	Without brake	With brake
230	1K030(H/T)-□S2	141	97	66	119	101	168	124	66	146	101	55	135	95 <sup>H7</sup>	100	115	3	10	19 <sup>H6</sup>	M5 × 12L	45	42	15.5	6 <sup>H9</sup>	6	3.5	4.5
	1K530(H/T)-□S2	159.5	115.5	84.5	137.5		186.5	142.5	84.5	164.5															4.4	5.4	
400	75030(F/C)-□S2	131.5	87.5	56.5	109.5		158.5	114.5	53.5	136.5	103														3.1	4.1	
	1K030(F/C)-□S2	141	97	66	119		168	124	63	146															3.5	4.5	
	1K530(F/C)-□S2	159.5	115.5	84.5	137.5		186.5	142.5	81.5	164.5															4.4	5.4	
	2K030(F/C)-□S2	178.5	134.5	103.5	156.5		205.5	161.5	100.5	183.5															5.3	6.3	
	3K030(F/C)-□S2	190	146	112	168	113	215	171	112	193	113	162	110 <sup>H7</sup>	120	145	12	22 <sup>H6</sup>				41	18	8 <sup>H9</sup>	7	8.3	9.4	
	4K030(F/C)-□S2	208	164	127	186	118	233	189	127	211	118	65	165		130	6	24 <sup>H6</sup>	M8 × 20L	55	51	20			11	12.6		
	5K030(F/C)-□S2	243	199	162	221		268	224	162	246															14	16	



Type 2000 r/min motors (230 V, 1 to 1.5 kW /400 V, 400 W to 5 kW)

Dimensions (mm)		Without brake					With brake					LR	Flange surface							Shaft end dimensions					Approx. mass (kg)			
Voltage	Model	LL	LM	KB1	KB2	KL1	LL	LM	KB1	KB2	KL1		LA	LB	LC	LD	LE	LG	LZ	S	Tap x Depth	K	QK	H	B	T	Without brake	With brake
230	1K020(H/T)-□S2	138	94	60	116	116	163	119	60	141	116	55	165	110 <sup>h7</sup>	130	145	6	12	9	22 <sup>h6</sup>	M5 x 12L	45	41	18	8 <sup>h9</sup>	7	5.2	6.7
	1K520(H/T)-□S2	155.5	111.5	77.5	133.5	101	180.5	136.5	77.5	158.5	103															6.7	8.2	
400	40020(F/C)-□S2	131.5	87.5	56.5	109.5	101	158.5	114.5	53.5	136.5	103		135	95 <sup>h7</sup>	100	115	3	10		19 <sup>h6</sup>		42	15.5	6 <sup>h9</sup>	6	3.1	4.1	
	60020(F/C)-□S2	141	97	66	119		168	124	63	146																3.5	4.5	
	1K020(F/C)-□S2	138	94	60	116	116	163	119	57	141	118		165	110 <sup>h7</sup>	130	145	6	12		22 <sup>h6</sup>		41	18	8 <sup>h9</sup>	7	5.2	6.7	
	1K520(F/C)-□S2	155.5	111.5	77.5	133.5		180.5	136.5	74.5	158.5																	6.7	8.2
	2K020(F/C)-□S2	173	129	95	151		198	154	92	176																	8	9.5
	3K020(F/C)-□S2	208	164	127	186	118	233	189	127	211		65									24 <sup>h6</sup>	M8 x 20L	55	51	20		11	12.6
	4K020(F/C)-□S2	177	133	96	155	140	202	158	96	180	140	70	233	114.3 <sup>h7</sup>	176	200	3.2	18	13.5	35 <sup>h6</sup>	M12 x 25L		50	30	10 <sup>h9</sup>	8	15.5	18.7
5K020(F/C)-□S2	196	152	115	174		221	177	115	199																	18.6	21.8	



Type 1500 r/min motors (400 V, 7.5kW)

Dimensions (mm)		Without brake							With brake							Approx. mass (kg)	
Voltage	Model	LL	LM	KB1	KB2	L1	L2	L3	LL	LM	KB1	KB2	L1	L2	L3	Without brake	With brake
400	7K515C-□S2	312	268	219	290	117.5	117.5	149	337	293	253	315	117.5	152.5	183	36.4	40.4



Type 1500 r/min motors (400 V, 11 to 15 kW)

Dimensions (mm)		Without brake							With brake							Approx. Mass (kg)	
Voltage	Model	LL	LM	KB1	KB2	L1	L2	L3	LL	LM	KB1	KB2	L1	L2	L3	Without brake	With brake
400	R88M-K□																
	11K015C-□S2	316	272	232	294	124.5	124.5	162	364	320	266	342	124.5	159.5	196	52.7	58.9
	15K015C-□S2	384	340	300	362	158.5	158.5	230	432	388	334	410	158.5	193.5	264	70.2	76.3

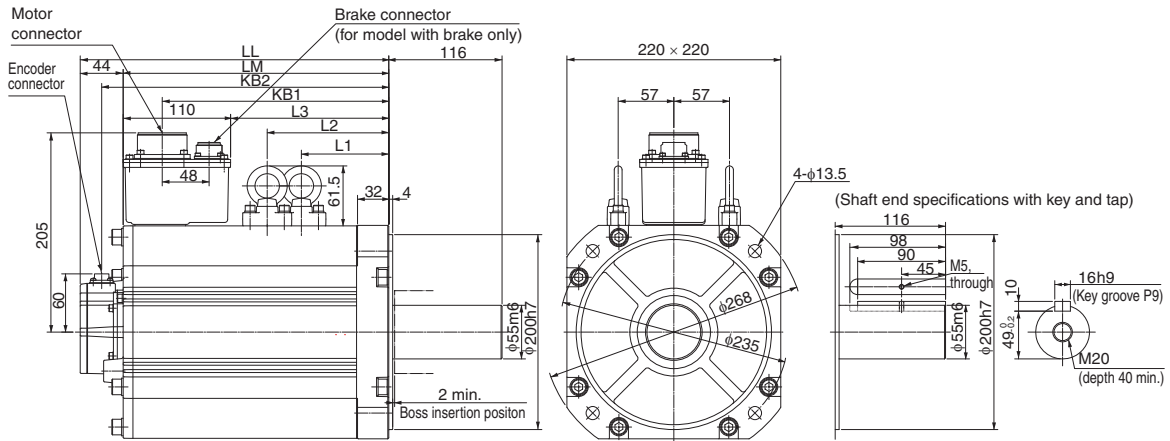

Type 1000 r/min motors (230 V, 900W/400 V, 900 W to 3 kW)

Dimensions (mm)		Without brake					With brake					LR	Flange surface							Shaft end dimensions					Approx. mass (kg)			
Voltage	Model	LL	LM	KB1	KB2	KL1	LL	LM	KB1	KB2	KL1		LA	LB	LC	LD	LE	LG	LZ	S	Tap x Depth	K	QK	H	B	T	Without brake	With brake
230	90010(H/T)-□S2	155.5	111.5	77.5	133.5	116	180.5	136.5	77.5	158.5	116	70	165	110 <sup>h7</sup>	130	145	6	12	9	22 <sup>h8</sup>	M5 x 12L	45	41	18	8 <sup>h9</sup>	7	6.7	8.2
400	90010(F/C)-□S2								74.5		118																	
	2K010(F/C)-□S2	163.5	119.5	82.5	141.5	140	188.5	144.5	82.5	166.5	140	80	233	114.3 <sup>h7</sup>	176	200	3.2	18	13.5	35 <sup>h8</sup>	M12 x 25L	55	50	30	10 <sup>h9</sup>	8	14	17.5
	3K010(F/C)-□S2	209.5	165.5	128.5	187.5		234.5	190.5	128.5	212.5																20	23.5	

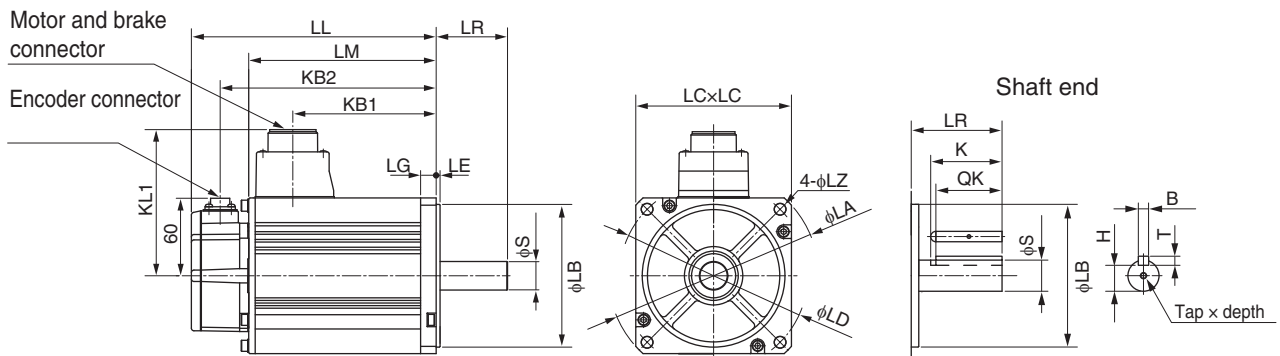

Type 1000 r/min motors (400 V, 4.5 kW)

Dimensions (mm)		Without brake						With brake						Approx. mass (kg)	
Voltage	Model	LL	LM	KB1	KB2	L1	L2	LL	LM	KB1	KB2	L1	L2	Without brake	With brake
400	R88M-K□ 4K510C-□S2	266	222	185	244	98	98	291	247	185	269	98	133	29.4	33.3



Type 1000 r/min motors (400 V, 6 kW)

Dimensions (mm)		Without brake							With brake						Approx. mass (kg)		
Voltage	Model	LL	LM	KB1	KB2	L1	L2	L3	LL	LM	KB1	KB2	L1	L2	L3	Without brake	With brake
400	R88M-K□ 6K010C-□S2	312	268	219	290	117.5	117.5	149	337	293	253	315	117.5	152.5	183	36.4	40.4

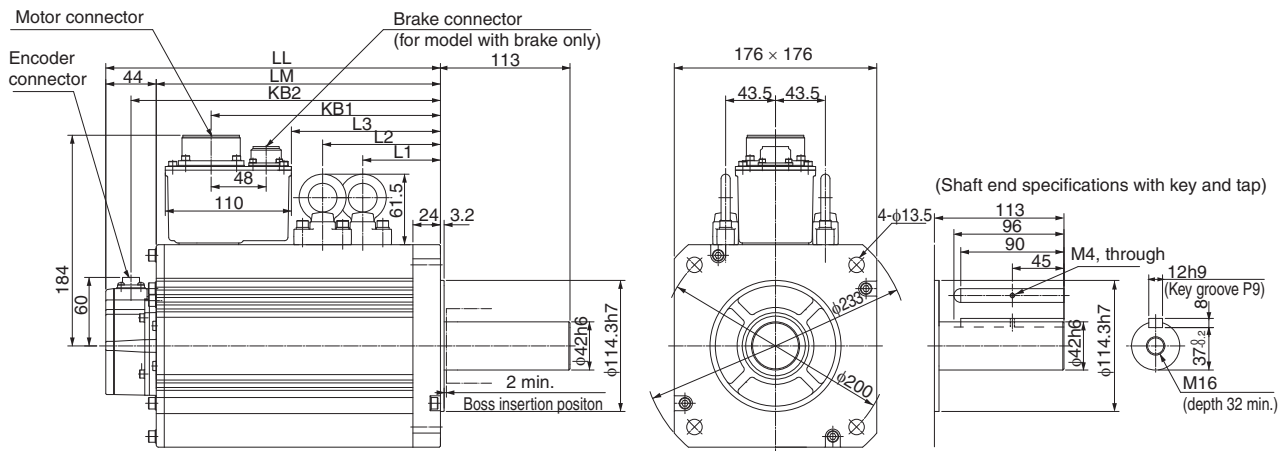

High inertia servo motors

Type 3000 r/min motors (230 V, 200 W to 750 W)

Dimensions (mm)		Without brake		With brake		KB1	LR	Flange surface					Shaft end dimensions						Approx. mass (kg)		
Voltage	Model	L	LL	L	LL			LA	LB	LC	LG	LZ	S	Tap x Depth	K	QK	H	B	T	Without brake	With brake
230	R88M-KH□																				
	20030(H/T)-□S2-D	129	99	165.5	135.5	42	30	70	50 <sup>h7</sup>	60	6.5	4.5	11 <sup>h6</sup>	M4x8L	20	18	8.5	4 <sup>h9</sup>	4	0.96	1.4
	40030(H/T)-□S2-D	148.5	118.5	185	155	61.5							14 <sup>h6</sup>	M5x10L	25	22.5	11	5 <sup>h9</sup>	5	1.4	1.8
	75030(H/T)-□S2-D	162.2	127.2	199.2	164.2	67.2	35	90	70 <sup>h7</sup>	80	8	6	19 <sup>h6</sup>	M5x10L	25	22	15.5	6 <sup>h9</sup>	6	2.5	3.3

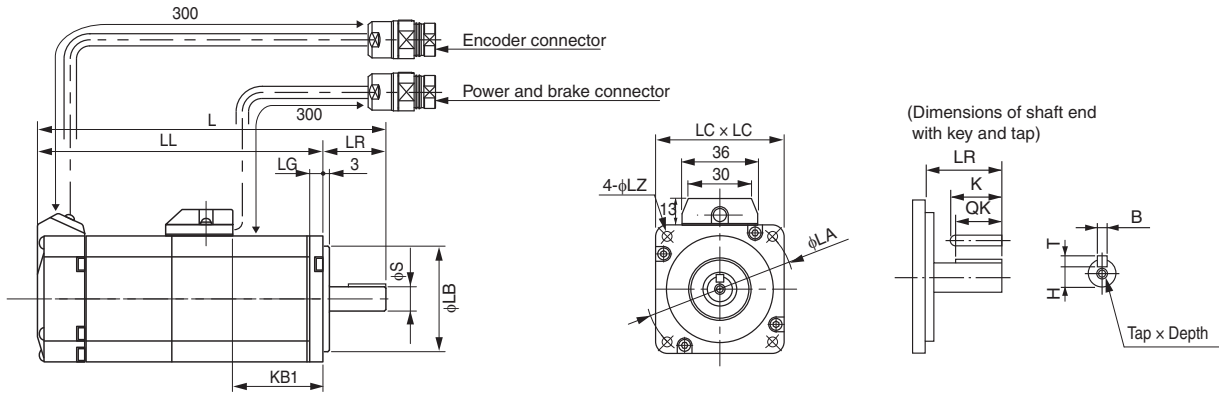

Encoder connector wiring



Cable length 300±30  
Connector optional  
Made by Hypertac  
SRUC-17G-MRWVN040 (MALE)

Power and brake connector wiring

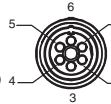

Cable length 300±30  
Connector optional  
Made by Hypertac  
SRUC-06J-MSCN236 (MALE)

Encoder connector	
Pin No.	Signal
1	BAT - (0 V)
2	BAT +
3	S +
4	S -
5 to 7	Free
8	ESV (power supply)
9	E0V (power supply)
10 to 17	Free
Connector case	FG (Ground)

\*Note: Pins 1 and 2 used only for motors with ABS encoder.

Power and brake connector	
Pin No.	Output
1	Phase U
2	Phase V
3	Phase W
4	*Brake terminal
5	*Brake terminal
6	FG (ground)

\*Note: Pins 4 and 5 used only for motors with brake.

Mating connector:  
Plug type: SPOC-06K-FSDN169 (FEMALE)

Mating connector:  
Plug type: SPOC-17H-FRON169 (FEMALE)

Type 2000 r/min motors (400 V, 1 kW to 5 kW)

Dimensions (mm)		Without brake			With brake			LR	Flange surface						Shaft end dimensions						Approx. mass (kg)							
Voltage	Model	LL	LM	KB1	KB2	KL1	LL		LM	KB1	KB2	KL1	LA	LB	LC	LD	LE	LG	LZ	S	K	QK	H	B	T	Without brake	With brake	
400	R88M-KH□																											
	1K020(F/C)-□S1	173	129	95	151	116	201	157	92	179	118	70	165	110 <sup>h7</sup>	130	145	6	12	9	22 <sup>h6</sup>	45	41	18	8 <sup>h9</sup>	7	6.7	8.1	
	1K520(F/C)-□S1	190.5	146.5	112.5	168.5		218.5	174.5	109.5	196.5																	8.6	10.1
	2K020(F/C)-□S1	177	133	96	155	140	206	162	96	184	140	80	233	114.3 <sup>h7</sup>	176	200	3.2	18	13.5	35 <sup>h6</sup>	55	50	30	10 <sup>h9</sup>	8	12.2	15.5	
	3K020(F/C)-□S1	196	152	115	174		225	181	115	203																	16.0	19.2
	4K020(F/C)-□S1	209.5	165.5	128.5	187.5		238.5	194.5	128.5	216.5																		18.6
	5K020(F/C)-□S1	238.5	194.5	157.5	216.5		267.5	223.5	157.5	245.5																	23.0	26.2



Type 1500 r/min motors (400 V, 7.5 kW)

Dimensions (mm)		Without brake							With brake							Approx. mass (kg)	
Voltage	Model	LL	LM	KB1	KB2	L1	L2	L3	LL	LM	KB1	KB2	L1	L2	L3	Without brake	With brake
	<b>R88M-KH□</b>																
400	7K515C-□S1	357	313	264	335	146.5	146.5	194	382	338	298	360	146.5	181.5	228	42.3	46.2

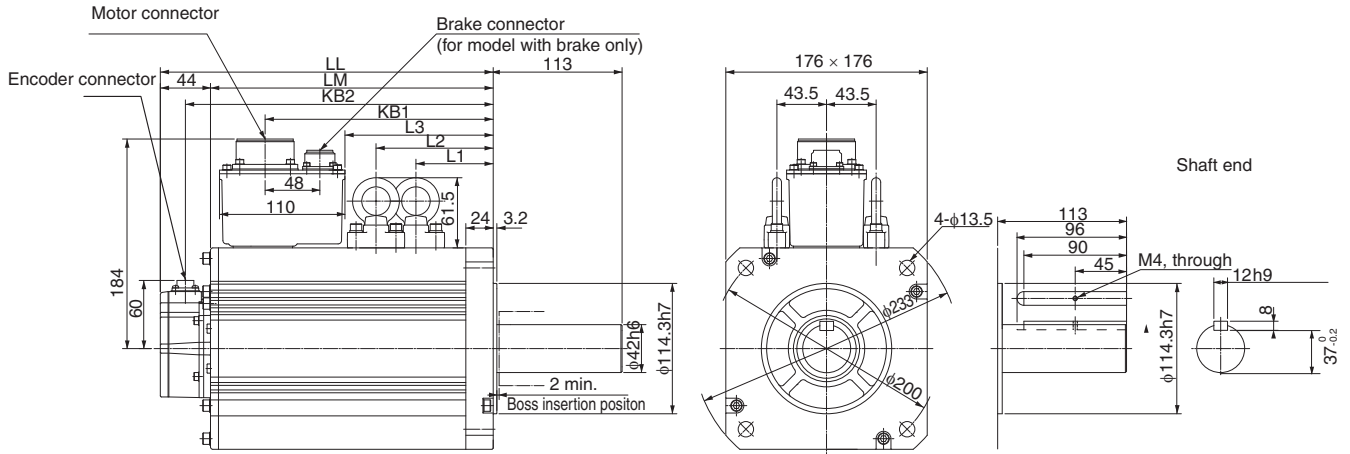



Ordering information

(Refer to servo drive chapter)

② Drive options



Accurax G5 servo drive  
EtherCAT, ML2 and  
Analogue/pulse models



④ Extension cable for  
absolute encoder  
(with battery holder)

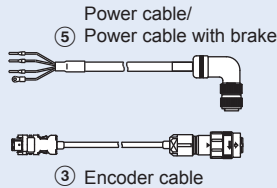
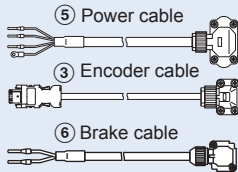

Standard servo motors



3000 rpm (50 W to 750 W)



3000 rpm (750 W to 5 kW)  
2000 rpm (400 W to 5 kW)  
1000 rpm (900 W to 3 kW)

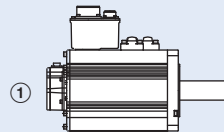

1500 rpm (7.5 kW to 15 kW)  
1000 rpm (4.5 kW to 6 kW)

High inertia servo motors



3000 rpm (200 W to 750 W)



2000 rpm (1 kW to 5 kW)

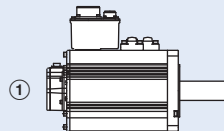

1500 rpm (7.5 kW)

**Note:** The symbols ①②③... show the recommended sequence to select the servo motor and cables

**Servo motor**



① Select motor from R88M-K or R88M-KH families using motor tables in next pages.

**Servo drive**

② Refer to Accurax G5 servo drive chapter for detailed drive specifications and selection of drive accessories.

Standard servo motors

Servo motors 3000 r/min (50 to 5000 W)

Symbol	Specifications				Servo motor model	Compatible servo drives <sup>(2)</sup>			
	Voltage	Encoder and design	Rated torque	Capacity		G5 EtherCAT/ ML2	G5 Analog/pulse		
<p>①</p>  <p>230V (50 to 750 W)</p>  <p>230 V (1 kW to 1.5 kW) 400 V (750 W to 5 kW)</p>	230 V	<b>Incremental encoder (20 bit)</b> Straight shaft with key and tap	Without brake	0.16 Nm	50 W	R88M-K05030H-S2	R88D-KN01H-□	R88D-KT01H	
				0.32 Nm	100 W	R88M-K10030H-S2	R88D-KN01H-□	R88D-KT01H	
				0.64 Nm	200 W	R88M-K20030H-S2	R88D-KN02H-□	R88D-KT02H	
				1.3 Nm	400 W	R88M-K40030H-S2	R88D-KN04H-□	R88D-KT04H	
				2.4 Nm	750 W	R88M-K75030H-S2	R88D-KN08H-□	R88D-KT08H	
				3.18 Nm	1000 W	R88M-K1K030H-S2	R88D-KN15H-□	R88D-KT15H	
			4.77 Nm	1500 W	R88M-K1K530H-S2	R88D-KN15H-□	R88D-KT15H		
			With brake	0.16 Nm	50 W	R88M-K05030H-BS2	R88D-KN01H-□	R88D-KT01H	
				0.32 Nm	100 W	R88M-K10030H-BS2	R88D-KN01H-□	R88D-KT01H	
				0.64 Nm	200 W	R88M-K20030H-BS2	R88D-KN02H-□	R88D-KT02H	
				1.3 Nm	400 W	R88M-K40030H-BS2	R88D-KN04H-□	R88D-KT04H	
				2.4 Nm	750 W	R88M-K75030H-BS2	R88D-KN08H-□	R88D-KT08H	
		3.18 Nm		1000 W	R88M-K1K030H-BS2	R88D-KN15H-□	R88D-KT15H		
		400 V	<b>Incremental encoder (20 bit)</b> Straight shaft with key and tap	Without brake	2.39 Nm	750 W	R88M-K75030F-S2	R88D-KN10F-□	R88D-KT10F
					3.18 Nm	1000 W	R88M-K1K030F-S2	R88D-KN15F-□	R88D-KT15F
					4.77 Nm	1500 W	R88M-K1K530F-S2	R88D-KN15F-□	R88D-KT15F
					6.37 Nm	2000 W	R88M-K2K030F-S2	R88D-KN20F-□	R88D-KT20F
					9.55 Nm	3000 W	R88M-K3K030F-S2	R88D-KN30F-□	R88D-KT30F
					12.7 Nm	4000 W	R88M-K4K030F-S2	R88D-KN50F-□	R88D-KT50F
				With brake	2.39 Nm	750 W	R88M-K75030F-BS2	R88D-KN10F-□	R88D-KT10F
					3.18 Nm	1000 W	R88M-K1K030F-BS2	R88D-KN15F-□	R88D-KT15F
					4.77 Nm	1500 W	R88M-K1K530F-BS2	R88D-KN15F-□	R88D-KT15F
					6.37 Nm	2000 W	R88M-K2K030F-BS2	R88D-KN20F-□	R88D-KT20F
					9.55 Nm	3000 W	R88M-K3K030F-BS2	R88D-KN30F-□	R88D-KT30F
	12.7 Nm				4000 W	R88M-K4K030F-BS2	R88D-KN50F-□	R88D-KT50F	
	400 V	<b>Absolute encoder (17 bit)</b> Straight shaft with key and tap	Without brake	2.39 Nm	750 W	R88M-K75030C-S2	R88D-KN10F-□	R88D-KT10F	
				3.18 Nm	1000 W	R88M-K1K030C-S2	R88D-KN15F-□	R88D-KT15F	
				4.77 Nm	1500 W	R88M-K1K530C-S2	R88D-KN15F-□	R88D-KT15F	
				6.37 Nm	2000 W	R88M-K2K030C-S2	R88D-KN20F-□	R88D-KT20F	
				9.55 Nm	3000 W	R88M-K3K030C-S2	R88D-KN30F-□	R88D-KT30F	
				12.7 Nm	4000 W	R88M-K4K030C-S2	R88D-KN50F-□	R88D-KT50F	
			With brake	2.39 Nm	750 W	R88M-K75030C-BS2	R88D-KN10F-□	R88D-KT10F	
				3.18 Nm	1000 W	R88M-K1K030C-BS2	R88D-KN15F-□	R88D-KT15F	
				4.77 Nm	1500 W	R88M-K1K530C-BS2	R88D-KN15F-□	R88D-KT15F	
				6.37 Nm	2000 W	R88M-K2K030C-BS2	R88D-KN20F-□	R88D-KT20F	
				9.55 Nm	3000 W	R88M-K3K030C-BS2	R88D-KN30F-□	R88D-KT30F	
				12.7 Nm	4000 W	R88M-K4K030C-BS2	R88D-KN50F-□	R88D-KT50F	



Servo motors 2000 r/min (1 to 5 kW)

Symbol	Specifications				Servo motor model	Compatible servo drives (2)				
	Voltage	Encoder and design	Rated torque	Capacity		G5 EtherCAT/ ML2	G5 Analog/pulse			
	230 V	Incremental encoder (20 bit) Straight shaft with key and tap	Without brake	4.77 Nm	1000 W	R88M-K1K020H-S2	R88D-KN10H-□	R88D-KT10H		
				7.16 Nm	1500 W	R88M-K1K520H-S2	R88D-KN15H-□	R88D-KT15H		
			With brake	4.77 Nm	1000 W	R88M-K1K020H-BS2	R88D-KN10H-□	R88D-KT10H		
				7.16 Nm	1500 W	R88M-K1K520H-BS2	R88D-KN15H-□	R88D-KT15H		
			Absolute encoder (17 bit) Straight shaft with key and tap	Without brake	4.77 Nm	1000 W	R88M-K1K020T-S2	R88D-KN10H-□	R88D-KT10H	
					7.16 Nm	1500 W	R88M-K1K520T-S2	R88D-KN15H-□	R88D-KT15H	
		With brake		4.77 Nm	1000 W	R88M-K1K020T-BS2	R88D-KN10H-□	R88D-KT10H		
				7.16 Nm	1500 W	R88M-K1K520T-BS2	R88D-KN15H-□	R88D-KT15H		
		400 V		Incremental encoder (20 bit) Straight shaft with key and tap	Without brake	1.91 Nm	400 W	R88M-K40020F-S2	R88D-KN06F-□	R88D-KT06F
						2.86 Nm	600 W	R88M-K60020F-S2	R88D-KN06F-□	R88D-KT06F
			4.77 Nm			1000 W	R88M-K1K020F-S2	R88D-KN10F-□	R88D-KT10F	
			7.16 Nm			1500 W	R88M-K1K520F-S2	R88D-KN15F-□	R88D-KT15F	
	9.55 Nm		2000 W			R88M-K2K020F-S2	R88D-KN20F-□	R88D-KT20F		
	14.3 Nm		3000 W			R88M-K3K020F-S2	R88D-KN30F-□	R88D-KT30F		
	With brake		1.91 Nm		400 W	R88M-K40020F-BS2	R88D-KN06F-□	R88D-KT06F		
			2.86 Nm		600 W	R88M-K60020F-BS2	R88D-KN06F-□	R88D-KT06F		
			4.77 Nm		1000 W	R88M-K1K020F-BS2	R88D-KN10F-□	R88D-KT10F		
			7.16 Nm		1500 W	R88M-K1K520F-BS2	R88D-KN15F-□	R88D-KT15F		
			9.55 Nm		2000 W	R88M-K2K020F-BS2	R88D-KN20F-□	R88D-KT20F		
			14.3 Nm		3000 W	R88M-K3K020F-BS2	R88D-KN30F-□	R88D-KT30F		
	Absolute encoder (17 bit) Straight shaft with key and tap		Without brake		1.91 Nm	400 W	R88M-K40020C-S2	R88D-KN06F-□	R88D-KT06F	
					2.86 Nm	600 W	R88M-K60020C-S2	R88D-KN06F-□	R88D-KT06F	
					4.77 Nm	1000 W	R88M-K1K020C-S2	R88D-KN10F-□	R88D-KT10F	
					7.16 Nm	1500 W	R88M-K1K520C-S2	R88D-KN15F-□	R88D-KT15F	
		9.55 Nm			2000 W	R88M-K2K020C-S2	R88D-KN20F-□	R88D-KT20F		
		14.3 Nm			3000 W	R88M-K3K020C-S2	R88D-KN30F-□	R88D-KT30F		
	With brake	1.91 Nm	400 W	R88M-K40020C-BS2	R88D-KN06F-□	R88D-KT06F				
		2.86 Nm	600 W	R88M-K60020C-BS2	R88D-KN06F-□	R88D-KT06F				
4.77 Nm		1000 W	R88M-K1K020C-BS2	R88D-KN10F-□	R88D-KT10F					
7.16 Nm		1500 W	R88M-K1K520C-BS2	R88D-KN15F-□	R88D-KT15F					
9.55 Nm		2000 W	R88M-K2K020C-BS2	R88D-KN20F-□	R88D-KT20F					
14.3 Nm		3000 W	R88M-K3K020C-BS2	R88D-KN30F-□	R88D-KT30F					
			19.1 Nm	4000 W	R88M-K4K020C-BS2	R88D-KN50F-□	R88D-KT50F			
			23.9 Nm	5000 W	R88M-K5K020C-BS2	R88D-KN50F-□	R88D-KT50F			

Servo motors 1500 r/min (7.5 to 15 kW)

Symbol	Specifications				Servo motor model	Compatible servo drives (2)		
	Voltage	Encoder and design	Rated torque	Capacity		G5 EtherCAT	G5 Analog/pulse	
	400 V	Absolute encoder (17 bit) Straight shaft with key and tap	Without brake	47.8 Nm	7500 W	R88M-K7K515C-S2	R88D-KN75F-ECT	R88D-KT75F
				70.0 Nm	11000 W	R88M-K11K015C-S2	R88D-KN150F-ECT	R88D-KT150F
				95.5 Nm	15000 W	R88M-K15K015C-S2	R88D-KN150F-ECT	R88D-KT150F
			With brake	47.8 Nm	7500 W	R88M-K7K515C-BS2	R88D-KN75F-ECT	R88D-KT75F
				70.0 Nm	11000 W	R88M-K11K015C-BS2	R88D-KN150F-ECT	R88D-KT150F
				95.5 Nm	15000 W	R88M-K15K015C-BS2	R88D-KN150F-ECT	R88D-KT150F

Servo motors 1000 r/min (900 to 6000 W)

Symbol	Specifications				Servo motor model	Compatible servo drives (2)		
	Voltage	Encoder and design	Rated torque	Capacity		G5 EtherCAT/ML2	G5 Analog/pulse	
 900 W - 3 kW   4.5 kW - 6 kW	230 V	Incremental encoder (20 bit) Straight shaft with key and tap	No brake	8.59 Nm	900 W	R88M-K90010H-S2	R88D-KN15H-□	R88D-KT15H
			With brake	8.59 Nm	900 W	R88M-K90010H-BS2	R88D-KN15H-□	R88D-KT15H
		Absolute encoder (17 bit) Straight shaft with key and tap	No brake	8.59 Nm	900 W	R88M-K90010T-S2	R88D-KN15H-□	R88D-KT15H
			With brake	8.59 Nm	900 W	R88M-K90010T-BS2	R88D-KN15H-□	R88D-KT15H
	400 V	Incremental encoder (20 bit) Straight shaft with key and tap	No brake	8.59 Nm	900 W	R88M-K90010F-S2	R88D-KN15F-□	R88D-KT15F
				19.1 Nm	2000 W	R88M-K2K010F-S2	R88D-KN30F-□	R88D-KT30F
			With brake	8.59 Nm	900 W	R88M-K90010F-BS2	R88D-KN15F-□	R88D-KT15F
				19.1 Nm	2000 W	R88M-K2K010F-BS2	R88D-KN30F-□	R88D-KT30F
		Absolute encoder (17 bit) Straight shaft with key and tap	No brake	28.7 Nm	3000 W	R88M-K3K010F-S2	R88D-KN50F-□	R88D-KT50F
				8.59 Nm	900 W	R88M-K90010C-S2	R88D-KN15F-□	R88D-KT15F
			With brake	19.1 Nm	2000 W	R88M-K2K010C-S2	R88D-KN30F-□	R88D-KT30F
				28.7 Nm	3000 W	R88M-K3K010C-S2	R88D-KN50F-□	R88D-KT50F
	400 V	Incremental encoder (20 bit) Straight shaft with key and tap	No brake	43.0 Nm	4500 W	R88M-K4K510C-S2	R88D-KN50F-□	R88D-KT50F
				57.3 Nm	6000 W	R88M-K6K010C-S2	R88D-KN75F-ECT	R88D-KT75F
			With brake	8.59 Nm	900 W	R88M-K90010C-BS2	R88D-KN15F-□	R88D-KT15F
				19.1 Nm	2000 W	R88M-K2K010C-BS2	R88D-KN30F-□	R88D-KT30F
Absolute encoder (17 bit) Straight shaft with key and tap		No brake	28.7 Nm	3000 W	R88M-K3K010C-BS2	R88D-KN50F-□	R88D-KT50F	
			43.0 Nm	4500 W	R88M-K4K510C-BS2	R88D-KN50F-□	R88D-KT50F	
		With brake	57.3 Nm	6000 W	R88M-K6K010C-BS2	R88D-KN75F-ECT	R88D-KT75F	
			8.59 Nm	900 W	R88M-K90010C-S2	R88D-KN15F-□	R88D-KT15F	

High inertia servo motors

Servo motors 3000 r/min (200 to 750 W)

Symbol	Specifications				Servo motor model	Compatible servo drives (2)		
	Voltage	Encoder and design	Rated torque	Capacity		G5 EtherCAT/ ML2	G5 Analog/pulse	
	230 V	Incremental encoder (20 bit) Straight shaft with key and tap	Without brake	0.64 Nm	200 W	R88M-KH20030H-S2-D	R88D-KN02H-□	R88D-KT02H
				1.3 Nm	400 W	R88M-KH40030H-S2-D	R88D-KN04H-□	R88D-KT04H
				2.4 Nm	750 W	R88M-KH75030H-S2-D	R88D-KN08H-□	R88D-KT08H
			With brake	0.64 Nm	200 W	R88M-KH20030H-BS2-D	R88D-KN02H-□	R88D-KT02H
				1.3 Nm	400 W	R88M-KH40030H-BS2-D	R88D-KN04H-□	R88D-KT04H
				2.4 Nm	750 W	R88M-KH75030H-BS2-D	R88D-KN08H-□	R88D-KT08H
		Absolute encoder (17 bit) Straight shaft with key and tap	Without brake	0.64 Nm	200 W	R88M-KH20030T-S2-D	R88D-KN02H-□	R88D-KT02H
				1.3 Nm	400 W	R88M-KH40030T-S2-D	R88D-KN04H-□	R88D-KT04H
				2.4 Nm	750 W	R88M-KH75030T-S2-D	R88D-KN08H-□	R88D-KT08H
			With brake	0.64 Nm	200 W	R88M-KH20030T-BS2-D	R88D-KN02H-□	R88D-KT02H
				1.3 Nm	400 W	R88M-KH40030T-BS2-D	R88D-KN04H-□	R88D-KT04H
				2.4 Nm	750 W	R88M-KH75030T-BS2-D	R88D-KN08H-□	R88D-KT08H

Servo motors 2000 r/min (1 to 5 kW)



Symbol	Specifications				Servo motor model	Compatible servo drives (2)		
	Voltage	Encoder and design	Rated torque	Capacity		G5 EtherCAT/ML2	G5 Analog/pulse	
	400 V	Incremental encoder (20 bit) Shaft end with key	Without brake	4.77 Nm	1000 W	R88M-KH1K020F-S1	R88D-KN10F-□	R88D-KT10F
				7.16 Nm	1500 W	R88M-KH1K520F-S1	R88D-KN15F-□	R88D-KT15F
				9.55 Nm	2000 W	R88M-KH2K020F-S1	R88D-KN20F-□	R88D-KT20F
				14.3 Nm	3000 W	R88M-KH3K020F-S1	R88D-KN30F-□	R88D-KT30F
				19.1 Nm	4000 W	R88M-KH4K020F-S1	R88D-KN50F-□	R88D-KT50F
				23.9 Nm	5000 W	R88M-KH5K020F-S1	R88D-KN50F-□	R88D-KT50F
			With brake	4.77 Nm	1000 W	R88M-KH1K020F-BS1	R88D-KN10F-□	R88D-KT10F
				7.16 Nm	1500 W	R88M-KH1K520F-BS1	R88D-KN15F-□	R88D-KT15F
				9.55 Nm	2000 W	R88M-KH2K020F-BS1	R88D-KN20F-□	R88D-KT20F
				14.3 Nm	3000 W	R88M-KH3K020F-BS1	R88D-KN30F-□	R88D-KT30F
				19.1 Nm	4000 W	R88M-KH4K020F-BS1	R88D-KN50F-□	R88D-KT50F
				23.9 Nm	5000 W	R88M-KH5K020F-BS1	R88D-KN50F-□	R88D-KT50F
		Absolute encoder (17 bit) Shaft end with key	Without brake	4.77 Nm	1000 W	R88M-KH1K020C-S1	R88D-KN10F-□	R88D-KT10F
				7.16 Nm	1500 W	R88M-KH1K520C-S1	R88D-KN15F-□	R88D-KT15F
				9.55 Nm	2000 W	R88M-KH2K020C-S1	R88D-KN20F-□	R88D-KT20F
				14.3 Nm	3000 W	R88M-KH3K020C-S1	R88D-KN30F-□	R88D-KT30F
				19.1 Nm	4000 W	R88M-KH4K020C-S1	R88D-KN50F-□	R88D-KT50F
				23.9 Nm	5000 W	R88M-KH5K020C-S1	R88D-KN50F-□	R88D-KT50F
			With brake	4.77 Nm	1000 W	R88M-KH1K020C-BS1	R88D-KN10F-□	R88D-KT10F
				7.16 Nm	1500 W	R88M-KH1K520C-BS1	R88D-KN15F-□	R88D-KT15F
				9.55 Nm	2000 W	R88M-KH2K020C-BS1	R88D-KN20F-□	R88D-KT20F
				14.3 Nm	3000 W	R88M-KH3K020C-BS1	R88D-KN30F-□	R88D-KT30F
				19.1 Nm	4000 W	R88M-KH4K020C-BS1	R88D-KN50F-□	R88D-KT50F
				23.9 Nm	5000 W	R88M-KH5K020C-BS1	R88D-KN50F-□	R88D-KT50F

Servo motors 1500 r/min (7.5 kW)

Symbol	Specifications				Servo motor model	Compatible servo drives (2)		
	Voltage	Encoder and design		Rated torque		Capacity	G5 EtherCAT	G5 Analog/pulse
	400 V	Absolute encoder (17 bit) Shaft end with key	Without brake	47.8 Nm	7500 W	R88M-KH7K515C-S1	R88D-KN75F-ECT	R88D-KT75F
			With brake	47.8 Nm	7500 W	R88M-KH7K515C-BS1	R88D-KN75F-ECT	R88D-KT75F

Encoder cables

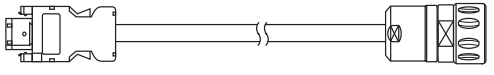
For absolute and incremental encoders

Symbol	Specifications	Model	Appearance
③	Encoder cable for servomotors R88M-K(050/100/200/400/750)30(H/T)□	1.5 m R88A-CRKA001-5CR-E	
		3 m R88A-CRKA003CR-E	
		5 m R88A-CRKA005CR-E	
		10 m R88A-CRKA010CR-E	
		15 m R88A-CRKA015CR-E	
	Encoder cable for servomotors R88M-KH(200/400/750)30(H/T)□	3 m R88A-CRWA003C-DE	
		5 m R88A-CRWA005C-DE	
		10 m R88A-CRWA010C-DE	
		15 m R88A-CRWA015C-DE	
	Encoder cable for servomotors R88M-K(1K0/1K5)30(H/T)□ R88M-K(750/1K0/1K5/2K0/3K0/4K0/5K0)30(F/C)□ R88M-K(400/600/1K0/1K5/2K0/3K0/4K0/5K0)20□ R88M-K(7K5/11K0/15K0)15□ R88M-K(900/2K0/3K0/4K5/6K0)10□ R88M-KH(1K0/1K5/2K0/3K0/4K0/5K0)20(F/C)□ R88M-KH7K515C□	1.5 m R88A-CRKC001-5NR-E	
3 m R88A-CRKC003NR-E			
5 m R88A-CRKC005NR-E			
10 m R88A-CRKC010NR-E			
15 m R88A-CRKC015NR-E			
20 m R88A-CRKC020NR-E			

Note: For servomotors fitted with an absolute encoder you have to add the extension battery cable R88A-CRGD0R3C□ (see below) or connect a backup battery in the CN1 I/O connector.

Absolute encoder battery cable (encoder extension cable only)

Symbol	Specifications	Model	Appearance
④	Absolute encoder battery cable	Battery not included 0.3 m R88A-CRGD0R3C-E	
		Battery included 0.3 m R88A-CRGD0R3C-BS-E	
	Absolute encoder backup battery 2,000 mA.h 3.6V	R88A-BAT01G	

Power cables

Symbol	Specifications	Model	Appearance	
⑤	For 200 V servomotors R88M-K(050/100/200/400/750)30(H/T)-□□S2 Note: for servomotors with brake R88M-K(050/100/200/400/750)30(H/T)-BS2, the separate brake cable R88A-CAKA□□□BR-E is needed	Power cable only (without brake)	1.5 m R88A-CAKA001-5SR-E	
			3 m R88A-CAKA003SR-E	
			5 m R88A-CAKA005SR-E	
			10 m R88A-CAKA010SR-E	
			15 m R88A-CAKA015SR-E	
			20 m R88A-CAKA020SR-E	
	For 200 V servomotors R88M-KH(200/400/750)30(H/T)-□□S2	without brake	3 m R88A-CAWA003S-DE	
			5 m R88A-CAWA005S-DE	
			10 m R88A-CAWA010S-DE	
		with brake	15 m R88A-CAWA015S-DE	
			20 m R88A-CAWA020S-DE	
			3 m R88A-CAWA003B-DE	
	5 m R88A-CAWA005B-DE			
	10 m R88A-CAWA010B-DE			
	15 m R88A-CAWA015B-DE			
	20 m R88A-CAWA020B-DE			

Symbol	Specifications		Model	Appearance	
⑤	For 200 V servomotors R88M-K(1K0/1K5)30(H/T)-□□S2 R88M-K(1K0/1K5)20(H/T)-□□S2 R88M-K90010(H/T)-□□S2	without brake	1.5 m	R88A-CAGB001-5SR-E	
			3 m	R88A-CAGB003SR-E	
			5 m	R88A-CAGB005SR-E	
			10 m	R88A-CAGB010SR-E	
			15 m	R88A-CAGB015SR-E	
		20 m	R88A-CAGB020SR-E		
		with brake	1.5 m	R88A-CAGB001-5BR-E	
			3 m	R88A-CAGB003BR-E	
			5 m	R88A-CAGB005BR-E	
			10 m	R88A-CAGB010BR-E	
	15 m		R88A-CAGB015BR-E		
	20 m	R88A-CAGB020BR-E			
	For 400 V servomotors R88M-K(750/1K0/1K5/2K0)30(F/C)-□□S2 R88M-K(400/600/1K0/1K5/2K0)20(F/C)-□□S2 R88M-K90010(F/C)-□□S2 R88M-KH(1K0/1K5)20(F/C)-□□S1	without brake	1.5 m	R88A-CAGB001-5SR-E	
			3 m	R88A-CAGB003SR-E	
			5 m	R88A-CAGB005SR-E	
			10 m	R88A-CAGB010SR-E	
			15 m	R88A-CAGB015SR-E	
		20 m	R88A-CAGB020SR-E		
		with brake	1.5 m	R88A-CAKF001-5BR-E	
			3 m	R88A-CAKF003BR-E	
5 m			R88A-CAKF005BR-E		
10 m			R88A-CAKF010BR-E		
15 m	R88A-CAKF015BR-E				
20 m	R88A-CAKF020BR-E				
For 400 V servomotors R88M-KH2K020(F/C)-□□S1	without brake	1.5 m	R88A-CAKC001-5SR-E		
		3 m	R88A-CAKC003SR-E		
		5 m	R88A-CAKC005SR-E		
		10 m	R88A-CAKC010SR-E		
		15 m	R88A-CAKC015SR-E		
	20 m	R88A-CAKC020SR-E			
	with brake	1.5 m	R88A-CAKF001-5BR-E		
		3 m	R88A-CAKF003BR-E		
		5 m	R88A-CAKF005BR-E		
		10 m	R88A-CAKF010BR-E		
15 m		R88A-CAKF015BR-E			
20 m	R88A-CAKF020BR-E				
For 400 V servomotors R88M-K(3K0/4K0/5K0)30(F/C)-□□S2 R88M-K(3K0/4K0/5K0)20(F/C)-□□S2 R88M-K(2K0/3K0)10(F/C)-□□S2 R88M-K4K510C-□□S2 R88M-KH(3K0/4K0/5K0)20(F/C)-□□S1	without brake	1.5 m	R88A-CAGD001-5SR-E		
		3 m	R88A-CAGD003SR-E		
		5 m	R88A-CAGD005SR-E		
		10 m	R88A-CAGD010SR-E		
		15 m	R88A-CAGD015SR-E		
	20 m	R88A-CAGD020SR-E			
	with brake	1.5 m	R88A-CAGD001-5BR-E		
		3 m	R88A-CAGD003BR-E		
		5 m	R88A-CAGD005BR-E		
		10 m	R88A-CAGD010BR-E		
15 m		R88A-CAGD015BR-E			
20 m	R88A-CAGD020BR-E				
For 400 V servomotors R88M-K6K010C-□□S2 R88M-K7K515C-□□S2 R88M-KH7K515C-□□S1 <b>Note:</b> for servomotors with brake R88M-K(6K010/7K515)C-BS2 and R88M-KH7K515C-BS1 the separate brake cable R88A-CAGE□□BR-E is needed	Power cable only (without brake)	1.5 m	R88A-CAKE001-5SR-E		
		3 m	R88A-CAKE003SR-E		
		5 m	R88A-CAKE005SR-E		
		10 m	R88A-CAKE010SR-E		
		15 m	R88A-CAKE015SR-E		
		20 m	R88A-CAKE020SR-E		
For 400 V servomotors R88M-K(11K0/15K0)15C-□□S2 <b>Note:</b> for servomotors with brake R88M-K(11K0/15K0)15C-BS2, the separate brake cable R88A-CAGE□□BR-E is needed	Power cable only (without brake)	1.5 m	R88A-CAKG001-5SR-E		
		3 m	R88A-CAKG003SR-E		
		5 m	R88A-CAKG005SR-E		
		10 m	R88A-CAKG010SR-E		
		15 m	R88A-CAKG015SR-E		
		20 m	R88A-CAKG020SR-E		

**Brake cables (for 200 V 50 to 750 W servo motors and 400 V 6 to 15 kW servo motors)**

Symbol	Specifications	Model	Appearance	
⑥	Brake cable only. For 200 V servo motors with brake R88M-K(050/100/200/400/750)30(H/T)-BS2	1.5 m	R88A-CAKA001-5BR-E	
		3 m	R88A-CAKA003BR-E	
		5 m	R88A-CAKA005BR-E	
		10 m	R88A-CAKA010BR-E	
		15 m	R88A-CAKA015BR-E	
	20 m	R88A-CAKA020BR-E		
	Brake cable only. For 400 V servo motors with brake R88M-K6K010C-BS2 R88M-K(7K5/11K0/15K0)15C-BS2 R88M-KH7K515C-BS1	1.5 m	R88A-CAGE001-5BR-E	
		3 m	R88A-CAGE003BR-E	
		5 m	R88A-CAGE005BR-E	
		10 m	R88A-CAGE010BR-E	
15 m		R88A-CAGE015BR-E		
20 m	R88A-CAGE020BR-E			

Connectors for encoder, power and brake cables

Specifications		Applicable Servomotor	Model
Connectors for making encoder cables	Drive side (CN2)	All models	R88A-CNW01R
	Motor side	R88M-K(050/100/200/400/750)30(H/T)□	R88A-CNK02R
	Motor side	R88M-KH(200/400/750)□	SPOC-17H-FRON169
	Motor side	R88M-K(1K0/1K5)30(H/T)□ R88M-K(750/1K0/1K5/2K0/3K0/4K0/5K0)30(F/C)□ R88M-K(400/600/1K0/1K5/2K0/3K0/4K0/5K0)20□ R88M-K(900/2K0/3K0)10□ R88M-K(4K5/6K0)10C-□ R88M-K(7K5/11K0/15K0)15C-□ R88M-KH(1K0/1K5/2K0/3K0/4K0/5K0/7K5)□	R88A-CNK04R
	Motor side	R88M-K(050/100/200/400/750)30(H/T)□	R88A-CNK11A
Connectors for making power cables	Motor side	R88M-KH(200/400/750)30(H/T)□	SPOC-06K-FSDN169
	Motor side	R88M-K(1K0/1K5)30(H/T)-S2 R88M-K(1K0/1K5)20(H/T)-S2 R88M-K90010(H/T)-S2 R88M-K(750/1K0/1K5/2K0)30(F/C)-S2, R88M-K(400/600/1K0/1K5/2K0)20(F/C)-S2 R88M-K90010(F/C)-S2 R88M-KH(1K0/1K5)20(F/C)-S1	MS3108E20-4S
	Motor side	R88M-K(1K0/1K5)30(H/T)-BS2 R88M-K(1K0/1K5)20(H/T)-BS2 R88M-K90010(H/T)-BS2	MS3108E20-18S
	Motor side	R88M-K(750/1K0/1K5/2K0/3K0/4K0/5K0)30(F/C)-BS2 R88M-K(400/600/1K0/1K5/2K0/3K0/4K0/5K0)20(F/C)-BS2 R88M-K(900/2K0/3K0)10(F/C)-BS2 R88M-K4K510C-BS2 R88M-KH(1K0/1K5/2K0/3K0/4K0/5K0)20(F/C)-BS1	MS3108E24-11S
	Motor side	R88M-K(3K0/4K0/5K0)30(F/C)-S2 R88M-K(3K0/4K0/5K0)20(F/C)-S2 R88M-K(2K0/3K0)10(F/C)-S2 R88M-K4K510C-S2 R88M-KH(2K0/3K0/4K0/5K0)20(F/C)-S1	MS3108E22-22S
	Motor side	R88M-K6K010C-□ R88M-K(7K5/11K0/15K0)15C-□ R88M-KH7K515C-□S1	MS3108E32-17S
	Motor side	R88M-K(050/100/200/400/750)30(H/T)-BS2	R88A-CNK11B
	Motor side	R88M-K6K010C-BS2 R88M-K(7K5/11K0/15K0)15C-BS2 R88M-KH7K515C-BS1	MS3108E14S-2S

- Note:** 1. All cables listed are flexible and shielded (except the R88A-CAKA□□□-BR-E which is only a flexible cable).  
 2. All connectors and cables listed have IP67 class (except R88A-CNW01R connector and R88A-CRGD0R3C cable).

ALL DIMENSIONS SHOWN ARE IN MILLIMETERS.  
To convert millimeters into inches, multiply by 0.03937. To convert grams into ounces, multiply by 0.03527.