

R88M-K□, R88M-KH□

Accurax G5 servo motors

**Servo family for accurate motion control.
Power range extended up to 15 kW.**

- Standard and high inertia servo motor models
- Peak torque 300% of rated torque during 3 seconds or more depending on model
- High resolution serial encoder provided by 20 bits encoder
- IP67 protection in all models
- Ultra-light and compact size motor
- Low speed ripple and low torque ripple due to low torque cogging
- Various shaft, brake and seal options

Ratings

- 230 VAC from 50 W to 1.5 kW (rated torque from 0.16 to 8.59 Nm)
- 400 VAC from 400 W to 15 kW (rated torque from 1.91 Nm to 95.5 Nm)



System configuration

(Refer to servo drive chapter)

Servo drive options

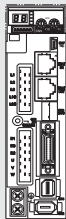

Accurax G5 servo drives
EtherCAT, ML2 and
Analogue/pulse models



Standard servo motors

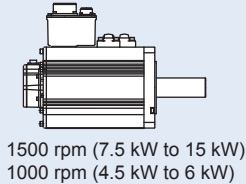
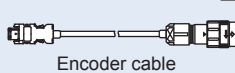
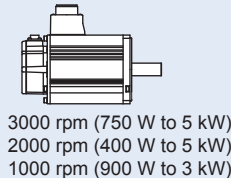

High inertia servo motors

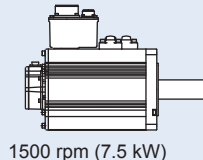
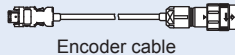
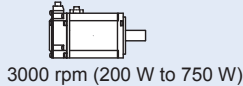

Servo motor / servo drive combination

Standard servo motors

| Accurax G5 rotary servo motor | | | | | | Accurax G5 servo drive models | | | | | |
|--|------------------------|------------------------|--|--------------------|------------------------|-------------------------------|----------------|--------------------|----------------|------------|----------------|
| | Voltage | Speed | Rated torque | Capacity | Model | EtherCAT | Analog/pulse | MECHATROLINK-II | | | |
|  | 230 V | 3000 min ⁻¹ | 0.16 Nm | 50 W | R88M-K05030(H/T)-□ | R88D-KN01H-ECT | R88D-KT01H | R88D-KN01H-ML2 | | | |
| | | | 0.32 Nm | 100 W | R88M-K10030(H/T)-□ | R88D-KN01H-ECT | R88D-KT01H | R88D-KN01H-ML2 | | | |
| | | | 0.64 Nm | 200 W | R88M-K20030(H/T)-□ | R88D-KN02H-ECT | R88D-KT02H | R88D-KN02H-ML2 | | | |
| | | | 1.3 Nm | 400 W | R88M-K40030(H/T)-□ | R88D-KN04H-ECT | R88D-KT04H | R88D-KN04H-ML2 | | | |
| | | | 2.4 Nm | 750 W | R88M-K75030(H/T)-□ | R88D-KN08H-ECT | R88D-KT08H | R88D-KN08H-ML2 | | | |
| | | | 3.18 Nm | 1000 W | R88M-K1K030(H/T)-□ | R88D-KN15H-ECT | R88D-KT15H | R88D-KN15H-ML2 | | | |
| | | | 4.77 Nm | 1500 W | R88M-K1K530(H/T)-□ | R88D-KN15H-ECT | R88D-KT15H | R88D-KN15H-ML2 | | | |
|  230 V (1 kW to 1.5 kW) 400 V (400 W to 5 kW) | 400 V | 3000 min ⁻¹ | 2.39 Nm | 750 W | R88M-K75030(F/C)-□ | R88D-KN10F-ECT | R88D-KT10F | R88D-KN10F-ML2 | | | |
| | | | 3.18 Nm | 1000 W | R88M-K1K030(F/C)-□ | R88D-KN15F-ECT | R88D-KT15F | R88D-KN15F-ML2 | | | |
| | | | 4.77 Nm | 1500 W | R88M-K1K530(F/C)-□ | R88D-KN15F-ECT | R88D-KT15F | R88D-KN15F-ML2 | | | |
| | | | 6.37 Nm | 2000 W | R88M-K2K030(F/C)-□ | R88D-KN20F-ECT | R88D-KT20F | R88D-KN20F-ML2 | | | |
| | | | 9.55 Nm | 3000 W | R88M-K3K030(F/C)-□ | R88D-KN30F-ECT | R88D-KT30F | R88D-KN30F-ML2 | | | |
| | | | 12.7 Nm | 4000 W | R88M-K4K030(F/C)-□ | R88D-KN50F-ECT | R88D-KT50F | R88D-KN50F-ML2 | | | |
| | | | 15.9 Nm | 5000 W | R88M-K5K030(F/C)-□ | R88D-KN50F-ECT | R88D-KT50F | R88D-KN50F-ML2 | | | |
| | | |  7.5 kW to 15 kW | 230 V | 2000 min ⁻¹ | 4.77 Nm | 1000 W | R88M-K1K020(H/T)-□ | R88D-KN10H-ECT | R88D-KT10H | R88D-KN10H-ML2 |
| | | | | | | 7.16 Nm | 1500 W | R88M-K1K520(H/T)-□ | R88D-KN15H-ECT | R88D-KT15H | R88D-KN15H-ML2 |
| | | | | | | 1.91 Nm | 400 W | R88M-K40020(F/C)-□ | R88D-KN06F-ECT | R88D-KT06F | R88D-KN06F-ML2 |
| 2.86 Nm | 600 W | R88M-K60020(F/C)-□ | | | | R88D-KN06F-ECT | R88D-KT06F | R88D-KN06F-ML2 | | | |
| 4.77 Nm | 1000 W | R88M-K1K020(F/C)-□ | | | | R88D-KN10F-ECT | R88D-KT10F | R88D-KN10F-ML2 | | | |
| 7.16 Nm | 1500 W | R88M-K1K520(F/C)-□ | | | | R88D-KN15F-ECT | R88D-KT15F | R88D-KN15F-ML2 | | | |
| 9.55 Nm | 2000 W | R88M-K2K020(F/C)-□ | | | | R88D-KN20F-ECT | R88D-KT20F | R88D-KN20F-ML2 | | | |
| 400 V | 1500 min ⁻¹ | 14.3 Nm | 3000 W | R88M-K3K020(F/C)-□ | R88D-KN30F-ECT | R88D-KT30F | R88D-KN30F-ML2 | | | | |
| | | 19.1 Nm | 4000 W | R88M-K4K020(F/C)-□ | R88D-KN50F-ECT | R88D-KT50F | R88D-KN50F-ML2 | | | | |
| | | 23.9 Nm | 5000 W | R88M-K5K020(F/C)-□ | R88D-KN50F-ECT | R88D-KT50F | R88D-KN50F-ML2 | | | | |
| | | 47.8 Nm | 7500 W | R88M-K7K515C-□ | R88D-KN75F-ECT | R88D-KT75F | - | | | | |
|  | 230 V 400 V | 1000 min ⁻¹ | 70.0 Nm | 11000 W | R88M-K11K015C-□ | R88D-KN150F-ECT | R88D-KT150F | - | | | |
| | | | 95.5 Nm | 15000 W | R88M-K15K015C-□ | R88D-KN150F-ECT | R88D-KT150F | - | | | |
| | | | 8.59 Nm | 900 W | R88M-K90010(H/T)-□ | R88D-KN15H-ECT | R88D-KT15H | R88D-KN15H-ML2 | | | |
| | | | 8.59 Nm | 900 W | R88M-K90010(F/C)-□ | R88D-KN15F-ECT | R88D-KT15F | R88D-KN15F-ML2 | | | |
| | | | 19.1 Nm | 2000 W | R88M-K2K010(F/C)-□ | R88D-KN30F-ECT | R88D-KT30F | R88D-KN30F-ML2 | | | |
| | | | 28.7 Nm | 3000 W | R88M-K3K010(F/C)-□ | R88D-KN50F-ECT | R88D-KT50F | R88D-KN50F-ML2 | | | |
| | | | 43.0 Nm | 4500 W | R88M-K4K510C-□ | R88D-KN50F-ECT | R88D-KT50F | R88D-KN50F-ML2 | | | |
| | | | 57.3 Nm | 6000 W | R88M-K6K010C-□ | R88D-KN75F-ECT | R88D-KT75F | - | | | |

High inertia servo motors

| Accurax G5 rotary servo motor | | | | | | Accurax G5 servo drive models | | |
|---|---------|------------------------|--------------|----------|---------------------|-------------------------------|--------------|-----------------|
| | Voltage | Speed | Rated torque | Capacity | Model | EtherCAT | Analog/pulse | MECHATROLINK-II |
|  | 230 V | 3000 min ⁻¹ | 0.64 Nm | 200 W | R88M-KH20030(H/T)-□ | R88D-KN02H-ECT | R88D-KT02H | R88D-KN02H-ML2 |
| | | | 1.3 Nm | 400 W | R88M-KH40030(H/T)-□ | R88D-KN04H-ECT | R88D-KT04H | R88D-KN04H-ML2 |
| | | | 2.4 Nm | 750 W | R88M-KH75030(H/T)-□ | R88D-KN08H-ECT | R88D-KT08H | R88D-KN08H-ML2 |
|  1 kW to 5 kW | 400 V | 2000 min ⁻¹ | 4.77 Nm | 1000 W | R88M-KH1K020(F/C)-□ | R88D-KN10F-ECT | R88D-KT10F | R88D-KN10F-ML2 |
| | | | 7.16 Nm | 1500 W | R88M-KH1K520(F/C)-□ | R88D-KN15F-ECT | R88D-KT15F | R88D-KN15F-ML2 |
| | | | 9.55 Nm | 2000 W | R88M-KH2K020(F/C)-□ | R88D-KN20F-ECT | R88D-KT20F | R88D-KN20F-ML2 |
| | | | 14.3 Nm | 3000 W | R88M-KH3K020(F/C)-□ | R88D-KN30F-ECT | R88D-KT30F | R88D-KN30F-ML2 |
| | | | 19.1 Nm | 4000 W | R88M-KH4K020(F/C)-□ | R88D-KN50F-ECT | R88D-KT50F | R88D-KN50F-ML2 |
| | | | 23.9 Nm | 5000 W | R88M-KH5K020(F/C)-□ | R88D-KN50F-ECT | R88D-KT50F | R88D-KN50F-ML2 |
|  7.5 kW | 400 V | 1500 min ⁻¹ | 47.8 Nm | 7500 W | R88M-KH7K515C-□ | R88D-KN75F-ECT | R88D-KT75F | - |

Note: 1. For servo motor and cables part numbers refer to ordering information at the end of this chapter
 2. Refer to the servo drive chapter for drive options selection and detailed specifications

Servo motor type designation

Standard servo motors

R88M-K05030H-BOS2

Accurax G5 servomotor

Capacity

| | |
|------|--------|
| 050 | 50 W |
| 100 | 100 W |
| 200 | 200 W |
| 400 | 400 W |
| 600 | 600 W |
| 750 | 750 W |
| 900 | 900 W |
| 1K0 | 1 kW |
| 1K5 | 1.5 kW |
| 2K0 | 2 kW |
| 3K0 | 3 kW |
| 4K0 | 4 kW |
| 4K5 | 4.5 kW |
| 5K0 | 5 kW |
| 6K0 | 6 kW |
| 7K5 | 7.5 kW |
| 11K0 | 11 kW |
| 15K0 | 15 kW |

Rated Speed (r/min)

| | |
|----|------|
| 10 | 1000 |
| 15 | 1500 |
| 20 | 2000 |
| 30 | 3000 |

Shaft end specifications

| | |
|-------|----------------------------------|
| Blank | Straight shaft, no key |
| S2 | Straight, key, tapped (standard) |

Oil seal specifications

| | |
|-------|-------------|
| Blank | No oil seal |
| O | Oil seal |

Brake specifications

| | |
|-------|----------|
| Blank | No brake |
| B | Brake |

Voltage and encoder specifications

- H: 230 V and 20-bit incremental encoder
- T: 230 V and 17-bit absolute encoder
- F: 400 V and 20-bit incremental encoder
- C: 400 V and 17-bit absolute encoder

High inertia servo motors

R88M-KH1K020F-BS1-D

Accurax G5 high inertia servomotor

Capacity

| | |
|-----|--------|
| 200 | 200 W |
| 400 | 400 W |
| 750 | 750 W |
| 1K0 | 1 kW |
| 1K5 | 1.5 kW |
| 2K0 | 2 kW |
| 3K0 | 3 kW |
| 4K0 | 4 kW |
| 5K0 | 5 kW |
| 7K5 | 7.5 kW |

Rated Speed (r/min)

| | |
|----|------|
| 15 | 1500 |
| 20 | 2000 |
| 30 | 3000 |

Circular connector (only for 230 V models)

Shaft end specifications

| | |
|-------|---|
| Blank | Straight shaft, no key |
| S1 | 400 V motor models - Shaft end with key (standard) |
| S2 | 230 V motor models - Straight, key, tapped (standard) |

Brake specifications

| | |
|-------|----------|
| Blank | No brake |
| B | Brake |

Voltage and encoder specifications

- H: 230 V and 20-bit incremental encoder
- T: 230 V and 17-bit absolute encoder
- F: 400 V and 20-bit incremental encoder
- C: 400 V and 17-bit absolute encoder

Servo motor specifications

Standard servo motors 3000 r/min, 230 V

Ratings and specifications

| Voltage | | 230 V | | | | | | | |
|---------------------------------------|---|---|----------|----------|----------|-----------------|-----------------------------|----------|--|
| Servo motor model R88M-K□ | 20-bit incremental encoder | 05030H-□ | 10030H-□ | 20030H-□ | 40030H-□ | 75030H-□ | 1K030H-□ | 1K530H-□ | |
| | 17-bit absolute encoder | 05030T-□ | 10030T-□ | 20030T-□ | 40030T-□ | 75030T-□ | 1K030T-□ | 1K530T-□ | |
| Rated output | W | 50 | 100 | 200 | 400 | 750 | 1000 | 1500 | |
| Rated torque | N·m | 0.16 | 0.32 | 0.64 | 1.3 | 2.4 | 3.18 | 4.77 | |
| Instantaneous peak torque | N·m | 0.48 | 0.95 | 1.91 | 3.8 | 7.1 | 9.55 | 14.3 | |
| Rated current | A (rms) | 1.1 | 1.1 | 1.5 | 2.4 | 4.1 | 6.6 | 8.2 | |
| Instantaneous max. current | A (rms) | 4.7 | 4.7 | 6.5 | 10.2 | 17.4 | 28 | 35 | |
| Rated speed | min ⁻¹ | 3000 | | | | | | | |
| Max. speed | min ⁻¹ | 6000 | | | | | 5000 | | |
| Torque constant | N·m/A | 0.11±10% | 0.21±10% | 0.31±10% | 0.39±10% | 0.42±10% | 0.37 | 0.45 | |
| Rotor moment of inertia (JM) | kg·m ² ×10 ⁻⁴ (without brake) | 0.025 | 0.051 | 0.14 | 0.26 | 0.87 | 2.03 | 2.84 | |
| | kg·m ² ×10 ⁻⁴ (with brake) | 0.027 | 0.054 | 0.16 | 0.28 | 0.97 | 2.35 | 3.17 | |
| Allowable load moment of inertia (JL) | Multiple of (JM) | 30 ¹ | | | | 20 ¹ | 15 ¹ | | |
| Rated power rate | kW/s (without brake) | 10.1 | 19.9 | 29.0 | 62.4 | 65.6 | 49.8 | 80.1 | |
| | kW/s (with brake) | 9.4 | 18.8 | 25.4 | 58 | 58.8 | 43 | 71.8 | |
| Allowable radial load | N | 68 | | | 245 | | 490 | | |
| Allowable thrust load | N | 58 | | | 98 | | 196 | | |
| Approx. mass | kg (without brake) | 0.32 | 0.47 | 0.82 | 1.2 | 2.3 | 3.5 | 4.4 | |
| | kg (with brake) | 0.53 | 0.68 | 1.3 | 1.7 | 3.1 | 4.5 | 5.4 | |
| Brake specifications | Rated voltage | 24 VDC ±10% | | | | | | | |
| | Holding brake moment of inertia J | kg·m ² ×10 ⁻⁴ 0.002 | | | 0.0018 | | 0.33 | | |
| | Power consumption (at 20°C) | W 7 | | | 9 | | 17 | 19 | |
| | Current consumption (at 20°C) | A 0.3 | | | 0.36 | | 0.70±10% | 0.81±10% | |
| | Static friction torque | N·m (minimum) 0.29 | | | 1.27 | | 2.5 | 7.8 | |
| | Release time | ms (max.) 35 | | | | | 50 | | |
| Basic specifications | Time Rating | Continuous | | | | | | | |
| | Insulation class | Type B | | | | | | Type F | |
| | Ambient operating/ storage temperature | 0 to +40°C/-20 to 65°C | | | | | | | |
| | Ambient operating/ storage humidity | 20% to 80% (non-condensing) | | | | | 20% to 85% (non-condensing) | | |
| | Vibration class | V-15 | | | | | | | |
| | Insulation resistance | 20 MΩ min. at 500 VDC between the power terminals and FG terminal | | | | | | | |
| | Enclosure | Totally-enclosed, self-cooling, IP67 (excluding shaft opening) | | | | | | | |
| | Vibration resistance | Vibration acceleration 49 m/s ² | | | | | | | |
| Mounting | Flange-mounted | | | | | | | | |

¹ Applicable load inertia: The operable load inertia ratio (load inertia/rotor inertia) depends on the mechanical configuration and its rigidity. For a machine with high rigidity, operation is possible even with high load inertia. Select an appropriate motor and confirm that operation is possible.

Torque-speed characteristics

R88M-K05030H/T (50 W)



R88M-K10030H/T (100 W)



R88M-K20030H/T (200 W)



R88M-K40030H/T (400 W)

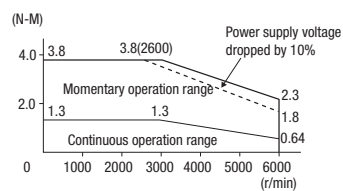

R88M-K75030H/T (750 W)

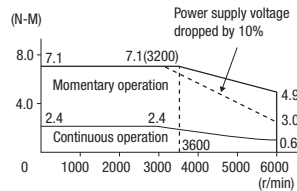

R88M-K1K030H/T (1 kW)

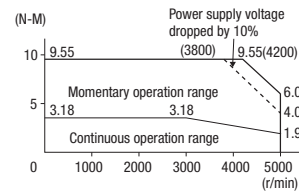

R88M-K1K530H/T (1.5 kW)

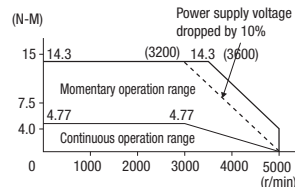

Standard servo motors 3000 r/min, 400 V

Ratings and specifications

| Voltage | | 400 V | | | | | | | |
|---------------------------------------|---|---|----------|----------|------------------|----------|----------|----------|------|
| Servo motor model R88M-K□ | 20-bit incremental encoder | 75030F-□ | 1K030F-□ | 1K530F-□ | 2K030F-□ | 3K030F-□ | 4K030F-□ | 5K030F-□ | |
| | 17-bit absolute encoder | 75030C-□ | 1K030C-□ | 1K530C-□ | 2K030C-□ | 3K030C-□ | 4K030C-□ | 5K030C-□ | |
| Rated output | W | 750 | 1000 | 1500 | 2000 | 3000 | 4000 | 5000 | |
| Rated torque | N·m | 2.39 | 3.18 | 4.77 | 6.37 | 9.55 | 12.7 | 15.9 | |
| Instantaneous peak torque | N·m | 7.16 | 9.55 | 14.3 | 19.1 | 28.6 | 38.2 | 47.7 | |
| Rated current | A (rms) | 2.4 | 3.3 | 4.2 | 5.7 | 9.2 | 9.9 | 12 | |
| Instantaneous max. current | A (rms) | 10 | 14 | 18 | 24 | 39 | 42 | 51 | |
| Rated speed | min ⁻¹ | 3000 | | | | | | | |
| Max. speed | min ⁻¹ | 5000 | | | | | 4500 | | |
| Torque constant | N·m/A | 0.78 | 0.75 | 0.89 | 0.87 | 0.81 | 0.98 | | |
| Rotor moment of inertia (JM) | kg·m ² ×10 ⁻⁴ (without brake) | 1.61 | 2.03 | 2.84 | 3.68 | 6.5 | 12.9 | 17.4 | |
| | kg·m ² ×10 ⁻⁴ (with brake) | 1.93 | 2.35 | 3.17 | 4.01 | 7.85 | 14.2 | 18.6 | |
| Allowable load moment of inertia (JL) | Multiple of (JM) | 20 ⁻¹ | | | 15 ⁻¹ | | | | |
| Rated power rate | kW/s (without brake) | 35.5 | 49.8 | 80.1 | 110 | 140 | 126 | 146 | |
| | kW/s (with brake) | 29.6 | 43 | 71.8 | 101 | 116 | 114 | 136 | |
| Allowable radial load | N | 490 | | | | 784 | | | |
| Allowable thrust load | N | 196 | | | | 343 | | | |
| Approx. mass | kg (without brake) | 3.1 | 3.5 | 4.4 | 5.3 | 8.3 | 11 | 14 | |
| | kg (with brake) | 4.1 | 4.5 | 5.4 | 6.3 | 9.4 | 12.6 | 16 | |
| Brake specifications | Rated voltage | 24 VDC ±10% | | | | | | | |
| | Holding brake moment of inertia J | kg·m ² ×10 ⁻⁴ 0.33 | | | | | | 1.35 | |
| | Power consumption (at 20°C) | W | 17 | 19 | | | | 22 | |
| | Current consumption (at 20°C) | A | 0.70±10% | | | 0.81±10% | | 0.90±10% | |
| | Static friction torque | N·m (minimum) | 2.5 | | 7.8 | | 11.8 | | 16.1 |
| | Rise time for holding torque | ms (max.) | 50 | | | | 110 | | |
| Release time | ms (max) | 15 | | | | 50 | | | |
| Basic specifications | Time Rating | Continuous | | | | | | | |
| | Insulation class | Type F | | | | | | | |
| | Ambient operating/ storage temperature | 0 to +40°C/-20 to 65°C | | | | | | | |
| | Ambient operating/ storage humidity | 20% to 85% (non-condensing) | | | | | | | |
| | Vibration class | V-15 | | | | | | | |
| | Insulation resistance | 20 MΩ min. at 500 VDC between the power terminals and FG terminal | | | | | | | |
| | Enclosure | Totally-enclosed, self-cooling, IP67(excluding shaft opening) | | | | | | | |
| | Vibration resistance | Vibration acceleration 49 m/s ² | | | | | | | |
| Mounting | Flange-mounted | | | | | | | | |

*1 Applicable load inertia: The operable load inertia ratio (load inertia/rotor inertia) depends on the mechanical configuration and its rigidity. For a machine with high rigidity, operation is possible even with high load inertia. Select an appropriate motor and confirm that operation is possible.

Torque-speed characteristics

R88M-K75030F/C (750 W)

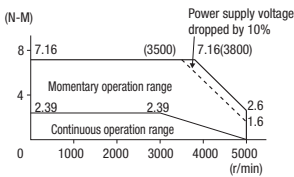

R88M-K1K030F/C (1 kW)

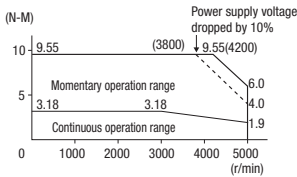

R88M-K1K530F/C (1.5 kW)

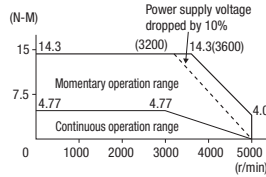

R88M-K2K030F/C (2 kW)

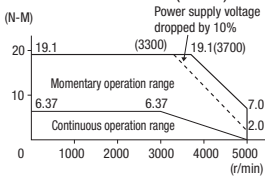

R88M-K3K030F/C (3 kW)

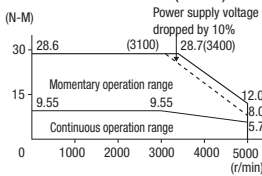

R88M-K4K030F/C (4 kW)

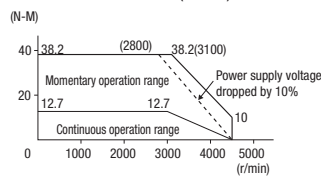

R88M-K5K030F/C (5 kW)

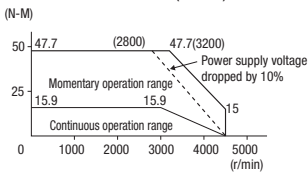

Standard servo motors 2000 r/min, 230 V/400 V

Ratings and specifications

| Voltage | | 230 V | | | | | 400 V | | | | |
|----------------------------------|--|---|----------|----------|-----------|----------|-----------|----------|----------|----------|----------|
| Servo motor model R88M-K□ | 20-bit incremental encoder | 1K020H-□ | 1K520H-□ | 40020F-□ | 60020F-□ | 1K020F-□ | 1K520F-□ | 2K020F-□ | 3K020F-□ | 4K020F-□ | 5K020F-□ |
| | 17-bit absolute encoder | 1K020T-□ | 1K520T-□ | 40020C-□ | 60020C-□ | 1K020C-□ | 1K520C-□ | 2K020C-□ | 3K020C-□ | 4K020C-□ | 5K020C-□ |
| Rated output | W | 1000 | 1500 | 400 | 600 | 1000 | 1500 | 2000 | 3000 | 4000 | 5000 |
| Rated torque | N·m | 4.77 | 7.16 | 1.91 | 2.86 | 4.77 | 7.16 | 9.55 | 14.3 | 19.1 | 23.9 |
| Instantaneous peak torque | N·m | 14.3 | 21.5 | 5.73 | 8.59 | 14.3 | 21.5 | 28.7 | 43 | 57.3 | 71.6 |
| Rated current | A (rms) | 5.7 | 9.4 | 1.2 | 1.5 | 2.8 | 4.7 | 5.9 | 8.7 | 10.6 | 13 |
| Instantaneous max. current | A (rms) | 24 | 40 | 4.9 | 6.5 | 12 | 20 | 25 | 37 | 45 | 55 |
| Rated speed | min ⁻¹ | 2000 | | | | | | | | | |
| Max. speed | min ⁻¹ | 3000 | | | | | | | | | |
| Torque constant | N·m/A | 0.63 | 0.58 | 1.27 | 1.38 | 1.27 | 1.16 | 1.27 | 1.18 | 1.40 | 1.46 |
| Rotor moment of inertia (JM) | kg·m ² ×10 ⁻⁴ (without brake) | 4.60 | 6.70 | 1.61 | 2.03 | 4.60 | 6.70 | 8.72 | 12.9 | 37.6 | 48 |
| | kg·m ² ×10 ⁻⁴ (with brake) | 5.90 | 7.99 | 1.90 | 2.35 | 5.90 | 7.99 | 10 | 14.2 | 38.6 | 48.8 |
| Max. load moment of inertia (JL) | Multiple of (JM) | 10 ¹ | | | | | | | | | |
| Rated power rate | kW/s (without brake) | 49.5 | 76.5 | 22.7 | 40.3 | 49.5 | 76.5 | 105 | 159 | 97.1 | 119 |
| | kW/s (with brake) | 38.6 | 64.2 | 19.2 | 34.8 | 38.6 | 64.2 | 91.2 | 144 | 94.5 | 117 |
| Allowable radial load | N | 490 | | | | | 784 | | | | |
| Allowable thrust load | N | 196 | | | | | 343 | | | | |
| Approx. mass | kg (without brake) | 5.2 | 6.7 | 3.1 | 3.5 | 5.2 | 6.7 | 8 | 11 | 15.5 | 18.6 |
| | kg (with brake) | 6.7 | 8.2 | 4.1 | 4.5 | 6.7 | 8.2 | 9.5 | 12.6 | 18.7 | 21.8 |
| Brake specifications | Rated voltage | 24VDC ±10% | | | | | | | | | |
| | Holding brake moment inertia | (J) kg·m ² ×10 ⁻⁴ 1.35 | | | | | | | | | 4.7 |
| | Power consumption (20°C) | W | 14 | 19 | 17 | 14 | 19 | 22 | 31 | | |
| | Current consumption (20°C) | A | 0.59±10% | 0.79±10% | 0.70 ±10% | 0.59±10% | 0.79 ±10% | 0.90±10% | 1.3±10% | 1.3 ±10% | |
| | Static friction torque | N·m (minimum) | 4.9 | 13.7 | 2.5 | 4.9 | 13.7 | 16.2 | 24.5 | | |
| | Rise time for holding torque | ms (max.) | 80 | 100 | 50 | 80 | 100 | 110 | 80 | | |
| Release time | ms (max) | 70 | 50 | 15 | 70 | 50 | 25 | | | | |
| Basic specifications | Time Rating | Continuous | | | | | | | | | |
| | Insulation class | Type F | | | | | | | | | |
| | Ambient operating/ storage temperature | 0 to +40°C/-20 to 65°C | | | | | | | | | |
| | Ambient operating/ storage humidity | 20% to 85% (non-condensing) | | | | | | | | | |
| | Vibration class | V-15 | | | | | | | | | |
| | Insulation resistance | 20 MΩ min. at 500 VDC between the power terminals and FG terminal | | | | | | | | | |
| Enclosure | Totally-enclosed, self-cooling, IP67 (excluding shaft opening) | | | | | | | | | | |
| Vibration resistance | Vibration acceleration 49 m/s ² | | | | | | | | | | |
| Mounting | Flange-mounted | | | | | | | | | | |

*1. Applicable load inertia: The operable load inertia ratio (load inertia/rotor inertia) depends on the mechanical configuration and its rigidity. For a machine with high rigidity, operation is possible even with high load inertia. Select an appropriate motor and confirm that operation is possible.

Torque-speed characteristics



Standard servo motors 1500 r/min, 400 V

Ratings and specifications

| Applied voltage | | 400 V | | |
|---------------------------------------|---|---|-----------|-----------|
| Servo motor model R88M-K□ | 17-bit absolute encoder | 7K515C-□ | 11K015C-□ | 15K015C-□ |
| Rated output | W | 7500 | 11000 | 15000 |
| Rated torque | N·m | 47.8 | 70.0 | 95.5 |
| Instantaneous peak torque | N·m | 119.0 | 175.0 | 224.0 |
| Rated current | A (rms) | 22.0 | 27.1 | 33.1 |
| Instantaneous max. current | A (rms) | 83 | 101 | 118 |
| Rated speed | min ⁻¹ | 1500 | | |
| Max. speed | min ⁻¹ | 3000 | 2000 | |
| Torque constant | N·m/A | 1.54 | 1.84 | 2.10 |
| Rotor moment of inertia (JM) | kg·m ² ×10 ⁻⁴ (without brake) | 101 | 212 | 302 |
| | kg·m ² ×10 ⁻⁴ (with brake) | 107 | 220 | 311 |
| Allowable load moment of inertia (JL) | Multiple of (JM) | 10 ⁻¹ | | |
| Rated power rate | kW/s (without brake) | 226 | 231 | 302 |
| | kW/s (with brake) | 213 | 223 | 293 |
| Allowable radial load | N | 1176 | 2254 | |
| Allowable thrust load | N | 490 | 686 | |
| Approx. mass | kg (without brake) | 36.4 | 52.7 | 70.2 |
| | kg (with brake) | 40.4 | 58.9 | 76.3 |
| Brake specifications | Rated voltage | 24VDC ±10% | | |
| | Holding brake moment of inertia J | kg·m ² ×10 ⁻⁴ | 4.7 | 7.1 |
| | Power consumption (at 20°C) | W | 34 | 26 |
| | Current consumption (at 20°C) | A | 1.4±10% | 1.08±10% |
| | Static friction torque | N·m (minimum) | 58.8 | 100 |
| | Release time | ms (max) | 50 | 140 |
| Basic specifications | Time Rating | Continuous | | |
| | Insulation class | Type F | | |
| | Ambient operating/ storage temperature | 0 to +40°C/-20 to 65°C | | |
| | Ambient operating/ storage humidity | 20% to 85% RH (non-condensing) | | |
| | Vibration class | V-15 | | |
| | Insulation resistance | 20 MΩ min. at 500 VDC between the power terminals and FG terminal | | |
| | Enclosure | Totally-enclosed, self-cooling, IP67 (excluding shaft opening) | | |
| | Mounting | Flange-mounted | | |

*1 Applicable load inertia: The operable load inertia ratio (load inertia/rotor inertia) depends on the mechanical configuration and its rigidity. For a machine with high rigidity, operation is possible even with high load inertia. Select an appropriate motor and confirm that operation is possible.

Torque-speed characteristics



Standard servo motors 1000 r/min, 230 V/400 V

Ratings and specifications

| Applied voltage | | 230 V | | 400 V | | | |
|---------------------------------------|---|---|----------|----------|----------|----------|----------|
| Servo motor model R88M-K□ | 20-bit incremental encoder | 90010H-□ | 90010F-□ | 2K010F-□ | 3K010F-□ | | |
| | 17-bit absolute encoder | 90010T-□ | 90010C-□ | 2K010C-□ | 3K010C-□ | 4K510C-□ | 6K010C-□ |
| Rated output | W | 900 | 900 | 2000 | 3000 | 4500 | 6000 |
| Rated torque | N·m | 8.59 | | 19.1 | 28.7 | 43.0 | 57.3 |
| Instantaneous peak torque | N·m | 19.3 | | 47.7 | 71.7 | 107.0 | 143.0 |
| Rated current | A (rms) | 7.6 | 3.8 | 8.5 | 11.3 | 14.8 | 19.4 |
| Instantaneous max. current | A (rms) | 24 | 12 | 30 | 40 | 55 | 74 |
| Rated speed | min ⁻¹ | 1000 | | | | | |
| Max. speed | min ⁻¹ | 2000 | | | | | |
| Torque constant | N·m/A | 0.86 | 1.72 | 1.76 | 1.92 | 2.05 | 2.08 |
| Rotor moment of inertia (JM) | kg·m ² ×10 ⁻⁴ (without brake) | 6.70 | | 30.3 | 48.4 | 79.1 | 101 |
| | kg·m ² ×10 ⁻⁴ (with brake) | 7.99 | | 31.4 | 49.2 | 84.4 | 107 |
| Allowable load moment of inertia (JL) | Multiple of (JM) | 10 ¹ | | | | | |
| Rated power rate | kW/s (without brake) | 110 | | 120 | 170 | 233 | 325 |
| | kW/s (with brake) | 92.4 | | 116 | 167 | 219 | 307 |
| Allowable radial load | N | 686 | | 1176 | 1470 | | 1764 |
| Allowable thrust load | N | 196 | | 490 | | | 588 |
| Approx. mass | kg (without brake) | 6.7 | | 14 | 20 | 29.4 | 36.4 |
| | kg (with brake) | 8.2 | | 17.5 | 23.5 | 33.3 | 40.4 |
| Brake specifications | Rated voltage | 24VDC ±10% | | | | | |
| | Holding brake moment of inertia J | kg·m ² ×10 ⁻⁴ | | 1.35 | | 4.7 | |
| | Power consumption (at 20°C) | W | 19 | | 31 | 34 | |
| | Current consumption (at 20°C) | A | 0.79±10% | | 1.3±10% | 1.4±10% | |
| | Static friction torque | N·m (minimum) | 13.7 | | 24.5 | 58.8 | |
| | Rise time for holding torque | ms (max.) | 100 | | 80 | 150 | |
| | Release time | ms (max) | 50 | | 25 | 50 | |
| Basic specifications | Time Rating | Continuous | | | | | |
| | Insulation class | Type F | | | | | |
| | Ambient operating/ storage temperature | 0 to +40°C/-20 to 65°C | | | | | |
| | Ambient operating/ storage humidity | 20% to 85% RH (non-condensing) | | | | | |
| | Vibration class | V-15 | | | | | |
| | Insulation resistance | 20 MΩ min. at 500 VDC between the power terminals and FG terminal | | | | | |
| | Enclosure | Totally-enclosed, self-cooling, IP67 (excluding shaft opening) | | | | | |
| Vibration resistance | Vibration acceleration 49 m/s ² | | | | | | |
| Mounting | Flange-mounted | | | | | | |

*1 Applicable load inertia: The operable load inertia ratio (load inertia/rotor inertia) depends on the mechanical configuration and its rigidity. For a machine with high rigidity, operation is possible even with high load inertia. Select an appropriate motor and confirm that operation is possible.

Torque-speed characteristics

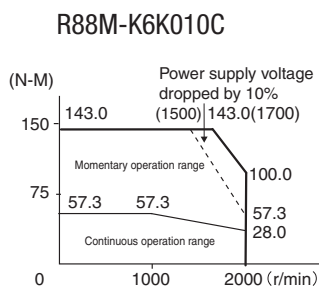
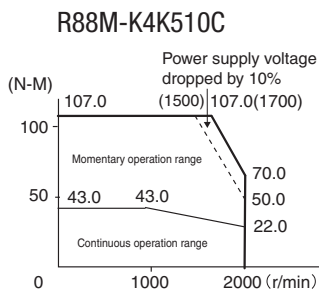
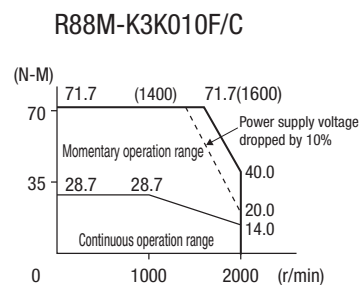
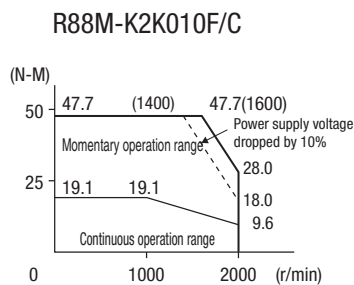
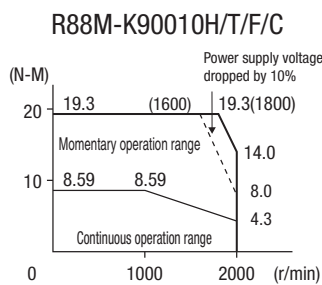

High inertia servo motors 3000 r/min, 230 V

Ratings and specifications

| Voltage | | 230 V | | |
|---------------------------------------|---|---|----------|----------|
| Servo motor model R88M-KH□ | 20-bit incremental encoder | 20030H-□ | 40030H-□ | 75030H-□ |
| | 17-bit absolute encoder | 20030T-□ | 40030T-□ | 75030T-□ |
| Rated output | W | 200 | 400 | 750 |
| Rated torque | N·m | 0.64 | 1.3 | 2.4 |
| Instantaneous peak torque | N·m | 1.91 | 3.8 | 7.1 |
| Rated current | A (rms) | 1.6 | 2.6 | 4.0 |
| Instantaneous max. current | A (rms) | 6.9 | 11.0 | 17.0 |
| Rated speed | min ⁻¹ | 3000 | | |
| Max. speed | min ⁻¹ | 5000 | | |
| Torque constant | N·m/A | 0.29±10% | 0.36±10% | 0.45±10% |
| Rotor moment of inertia (JM) | kg·m ² ×10 ⁻⁴ (without brake) | 0.42 | 0.67 | 1.51 |
| | kg·m ² ×10 ⁻⁴ (with brake) | 0.45 | 0.70 | 1.61 |
| Allowable load moment of inertia (JL) | Multiple of (JM) | 30 ^{*1} | | |
| Rated power rate | kW/s (without brake) | 9.58 | 24.1 | 37.7 |
| | kW/s (with brake) | 9.06 | 23.3 | 35.3 |
| Allowable radial load | N | 245 | | |
| Allowable thrust load | N | 98 | | |
| Approx. mass | kg (without brake) | 0.96 | 1.4 | 2.5 |
| | kg (with brake) | 1.4 | 1.8 | 3.3 |
| Brake specifications | Rated voltage | 24 VDC ±5% | | |
| | Holding brake moment of inertia J | kg·m ² ×10 ⁻⁴ | 0.018 | 0.075 |
| | Power consumption (at 20°C) | W | 9 | 10 |
| | Current consumption (at 20°C) | A | 0.36 | 0.42 |
| | Static friction torque | N·m (minimum) | 1.27 | 2.45 |
| | Release time | ms (max) | 15 | 20 |
| Basic specifications | Time Rating | Continuous | | |
| | Insulation class | Type B | | |
| | Ambient operating/ storage temperature | 0 to +40°C/-20 to 65°C | | |
| | Ambient operating/ storage humidity | 20% to 85% RH (non-condensing) | | |
| | Vibration class | V-15 | | |
| | Insulation resistance | 20 MΩ min. at 500 VDC between the power terminals and FG terminal | | |
| | Enclosure | Totally-enclosed, self-cooling, IP65 (excluding shaft opening and lead wire ends) | | |
| Vibration resistance | Vibration acceleration 49 m/s ² | | | |
| Mounting | Flange-mounted | | | |

*1 Applicable load inertia: The operable load inertia ratio (load inertia/rotor inertia) depends on the mechanical configuration and its rigidity. For a machine with high rigidity, operation is possible even with high load inertia. Select an appropriate motor and confirm that operation is possible.

Torque-speed characteristics

R88M-KH20030H/T (230 V, 200 W)



R88M-KH40030H/T (230 V, 400 W)



R88M-KH75030H/T (230 V, 750 W)



High inertia servo motors 2000 and 1500 r/min, 400 V

Ratings and specifications

| R/min, Voltage | | 2000 r/min, 400 V | | | | | | 1500 r/min, 400 V |
|----------------------------------|--|---|----------|----------|----------|----------|----------|-------------------|
| Servo motor model R88M-KH□ | 20-bit incremental encoder | 1K020F-□ | 1K520F-□ | 2K020F-□ | 3K020F-□ | 4K020F-□ | 5K020F-□ | |
| | 17-bit absolute encoder | 1K020C-□ | 1K520C-□ | 2K020C-□ | 3K020C-□ | 4K020C-□ | 5K020C-□ | 7K515C-□ |
| Rated output | W | 1000 | 1500 | 2000 | 3000 | 4000 | 5000 | 7500 |
| Rated torque | N·m | 4.77 | 7.16 | 9.55 | 14.3 | 19.1 | 23.9 | 47.8 |
| Instantaneous peak torque | N·m | 14.3 | 21.5 | 28.6 | 43.0 | 57.3 | 71.6 | 119 |
| Rated current | A (rms) | 2.9 | 4.7 | 5.5 | 8.0 | 10.5 | 13.0 | 22.0 |
| Instantaneous max. current | A (rms) | 12 | 20 | 24 | 34 | 45 | 55 | 83 |
| Rated speed | min ⁻¹ | 2000 | | | | | | 1500 |
| Max. speed | min ⁻¹ | 3000 | | | | | | 3000 |
| Torque constant | N·m/A | 1.27 | 1.16 | 1.31 | 1.34 | 1.38 | 1.39 | 1.54 |
| Rotor moment of inertia (JM) | kg·m ² ×10 ⁻⁴ (without brake) | 24.7 | 37.1 | 57.8 | 90.2 | 112 | 162 | 273 |
| | kg·m ² ×10 ⁻⁴ (with brake) | 26.0 | 38.4 | 62.9 | 95.3 | 117 | 167 | 279 |
| Max. load moment of inertia (JL) | Multiple of (JM) | 5 ^{*1} | | | | | | |
| Rated power rate | kW/s (without brake) | 9.2 | 13.8 | 15.8 | 22.7 | 32.5 | 35.1 | 86.7 |
| | kW/s (with brake) | 8.8 | 13.4 | 14.5 | 21.5 | 31.1 | 34.1 | 85.1 |
| Allowable radial load | N | 490 | | | 784 | | | 1176 |
| Allowable thrust load | N | 196 | | | 343 | | | 490 |
| Approx. mass | kg (without brake) | 6.7 | 8.6 | 12.2 | 16.0 | 18.6 | 23.0 | 42.3 |
| | kg (with brake) | 8.1 | 10.1 | 15.5 | 19.2 | 21.8 | 26.2 | 46.2 |
| Rated voltage | | 24 VDC ±10% | | | | | | |
| Brake specifications | Holding brake moment inertia (J) kg·m ² ×10 ⁻⁴ | 1.35 | | | 4.7 | | | |
| | Power consumption (20°C) W | 14 | 19 | 31 | | | | 34 |
| | Current consumption (20°C) A | 0.59±10% | 0.79±10% | 1.30±10% | | | | 1.40±10% |
| | Static friction torque N·m (minimum) | 4.9 | 13.7 | 24.5 | | | | 58.8 |
| | Rise time for holding torque ms (max.) | 80 | 100 | 80 | | | | 150 |
| | Release time ms (max) | 70 | 50 | 25 | | | | 50 |
| | Time Rating | Continuous | | | | | | |
| Basic specifications | Insulation class | Type F | | | | | | |
| | Ambient operating/ storage temperature | 0 to +40°C/-20 to 65°C | | | | | | |
| | Ambient operating/ storage humidity | 20% to 85% RH (non-condensing) | | | | | | |
| | Vibration class | V-15 | | | | | | |
| | Insulation resistance | 20 MΩ min. at 500 VDC between the power terminals and FG terminal | | | | | | |
| | Enclosure | Totally-enclosed, self-cooling, IP67 (excluding shaft opening) | | | | | | |
| | Vibration resistance | Vibration acceleration 49 m/s ² | | | | | | |
| Mounting | Flange-mounted | | | | | | | |

*1 Applicable load inertia: The operable load inertia ratio (load inertia/rotor inertia) depends on the mechanical configuration and its rigidity. For a machine with high rigidity, operation is possible even with high load inertia. Select an appropriate motor and confirm that operation is possible.

Torque-speed characteristics

R88M-KH1K020F/C (400 V, 1 kW)



R88M-KH1K520F/C (400 V, 1.5 kW)

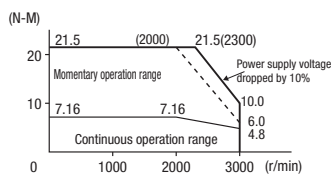

R88M-KH2K020F/C (400 V, 2 kW)

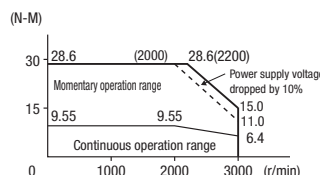

R88M-KH3K020F/C (400 V, 3 kW)

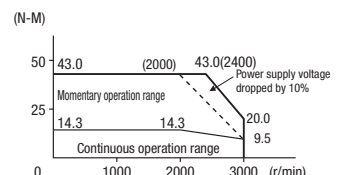

R88M-KH4K020F/C (400 V, 4 kW)

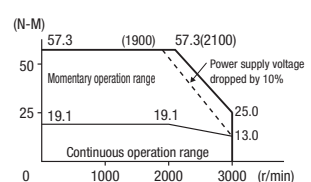

R88M-KH5K020F/C (400 V, 5 kW)

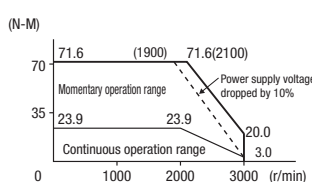

R88M-KH7K515C (7.5 kW)

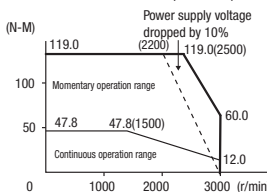

Dimensions

Standard servo motors

Type 3000 r/min motors (230 V, 50 to 100 W)

| Dimensions (mm) | Without brake | | With brake | | LN | Shaft end dimensions | Approx. mass (kg) | |
|----------------------|---------------|----|------------|----|----|----------------------|-------------------|------------|
| | LL | LM | LL | LM | | | Without brake | With brake |
| Model | | | | | | Tap × Depth | | |
| R88M-K05030(H/T)-□S2 | 72 | 48 | 102 | 78 | 23 | M3 × 6L | 0.32 | 0.53 |
| R88M-K10030(H/T)-□S2 | 92 | 68 | 122 | 98 | 43 | | 0.47 | 0.68 |

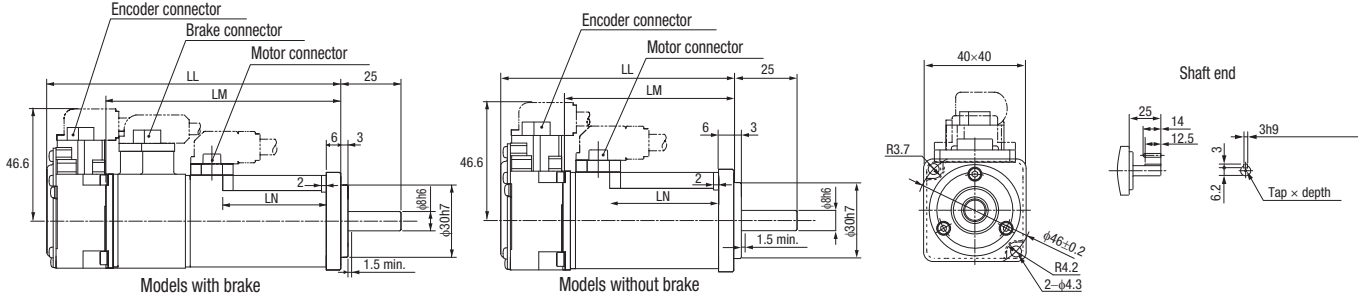

Type 3000 r/min motors (230 V, 200 to 750 W)

| Dimensions (mm) | Without brake | | | With brake | | | LR | Flange surface | | | | | | Shaft end dimensions | | | | | | Approx. mass kg | | |
|----------------------|---------------|------|------|------------|-------|------|----|------------------|----|----|----|-----|-----|----------------------|----|------|------|-----------------|---|-----------------|---------------|------------|
| | LL | LM | KL1 | LL | LM | KL1 | | LB | LC | LD | LE | LG | LZ | S | K | QK | H | B | T | Tap × Depth | Without brake | With brake |
| Model | | | | | | | | | | | | | | | | | | | | | | |
| R88M-K20030(H/T)-□S2 | 79.5 | 56.5 | 52.5 | 116 | 93 | 52.5 | 30 | 50 ^{H7} | 60 | 70 | 3 | 6.5 | 4.5 | 11 ^{H6} | 20 | 18 | 8.5 | 4 ^{H9} | 4 | M4 × 8L | 0.82 | 1.3 |
| R88M-K40030(H/T)-□S2 | 99 | 76 | 52.5 | 135.5 | 112.5 | 52.5 | | | | | | | | 14 ^{H6} | 25 | 22.5 | 11 | 5 ^{H9} | 5 | M5 × | 1.2 | 1.7 |
| R88M-K75030(H/T)-□S2 | 112.2 | 86.2 | 60 | 148.2 | 122.2 | 61.6 | 35 | 70 ^{H7} | 80 | 90 | | 8 | 6 | 19 ^{H6} | | 22 | 15.5 | 6 ^{H9} | 6 | 10L | 2.3 | 3.1 |

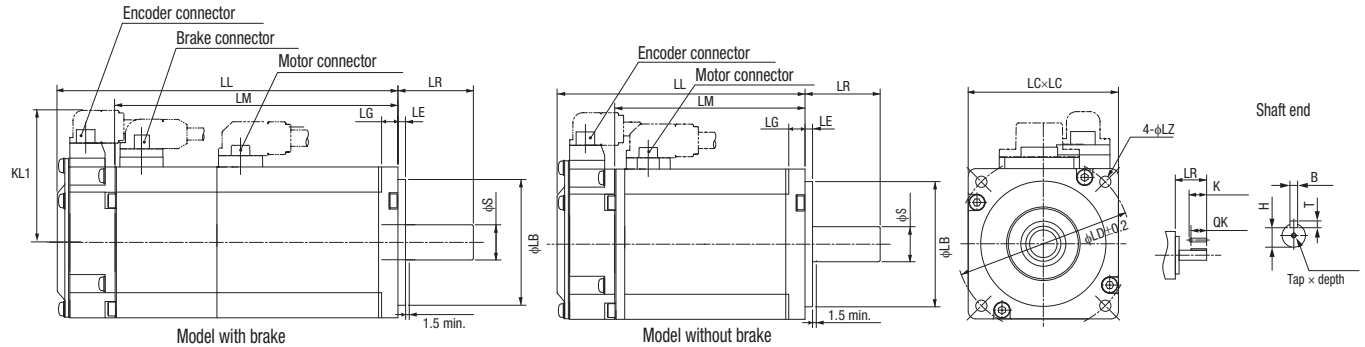

Type 3000 r/min motors (230 V, 1 to 1.5 kW/400V, 750 W to 5 kW)

| Voltage | Model | Without brake | | | | | With brake | | | | | LR | Flange surface | | | | | | Shaft end dimensions | | | | | | Approx. Mass (kg) | | |
|---------|----------------|---------------|-------|-------|-------|-----|------------|-------|-------|-------|-----|-----|-------------------|------------------|-----|-----|------------------|----------|----------------------|-------------|----|----|-----------------|-----------------|-------------------|---------------|------------|
| | | LL | LM | KB1 | KB2 | KL1 | LL | LM | KB1 | KB2 | KL1 | | LA | LB | LC | LD | LE | LG | S | Tap × Depth | K | QK | H | B | T | Without brake | With brake |
| 230 | 1K030(H/T)-□S2 | 141 | 97 | 66 | 119 | 101 | 168 | 124 | 66 | 146 | 101 | 55 | 135 | 95 ^{H7} | 100 | 115 | 3 | 10 | 19 ^{H6} | M5 × 12L | 45 | 42 | 15.5 | 6 ^{H9} | 6 | 3.5 | 4.5 |
| | 1K530(H/T)-□S2 | 159.5 | 115.5 | 84.5 | 137.5 | | 186.5 | 142.5 | 84.5 | 164.5 | | | | | | | | | | | | | | | 4.4 | 5.4 | |
| 400 | 75030(F/C)-□S2 | 131.5 | 87.5 | 56.5 | 109.5 | | 158.5 | 114.5 | 53.5 | 136.5 | 103 | | | | | | | | | | | | | | 3.1 | 4.1 | |
| | 1K030(F/C)-□S2 | 141 | 97 | 66 | 119 | | 168 | 124 | 63 | 146 | | | | | | | | | | | | | | | 3.5 | 4.5 | |
| | 1K530(F/C)-□S2 | 159.5 | 115.5 | 84.5 | 137.5 | | 186.5 | 142.5 | 81.5 | 164.5 | | | | | | | | | | | | | | | 4.4 | 5.4 | |
| | 2K030(F/C)-□S2 | 178.5 | 134.5 | 103.5 | 156.5 | | 205.5 | 161.5 | 100.5 | 183.5 | | | | | | | | | | | | | | | 5.3 | 6.3 | |
| | 3K030(F/C)-□S2 | 190 | 146 | 112 | 168 | 113 | 215 | 171 | 112 | 193 | 113 | 162 | 110 ^{H7} | 120 | 145 | 12 | 22 ^{H6} | | | | 41 | 18 | 8 ^{H9} | 7 | 8.3 | 9.4 | |
| | 4K030(F/C)-□S2 | 208 | 164 | 127 | 186 | 118 | 233 | 189 | 127 | 211 | 118 | 65 | 165 | | 130 | 6 | 24 ^{H6} | M8 × 20L | 55 | 51 | 20 | | | 11 | 12.6 | | |
| | 5K030(F/C)-□S2 | 243 | 199 | 162 | 221 | | 268 | 224 | 162 | 246 | | | | | | | | | | | | | | | 14 | 16 | |

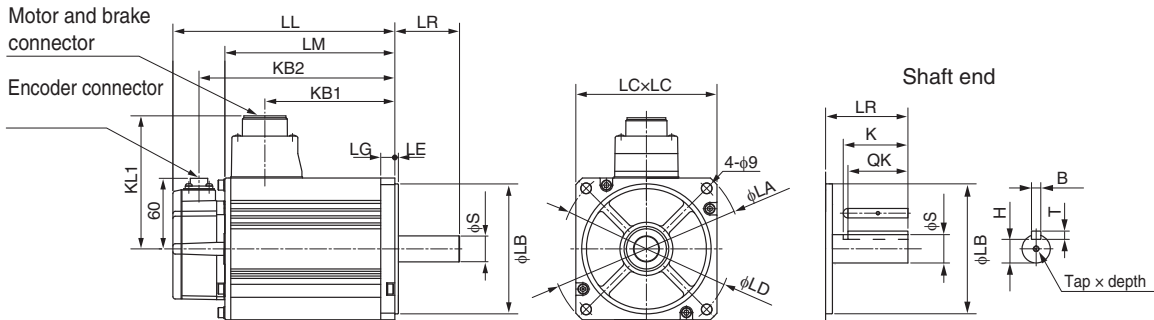

Type 2000 r/min motors (230 V, 1 to 1.5 kW /400 V, 400 W to 5 kW)

| Dimensions (mm) | | Without brake | | | | | With brake | | | | | LR | Flange surface | | | | | | | Shaft end dimensions | | | | | | Approx. mass (kg) | | |
|-----------------|----------------|---------------|-------|------|-------|-----|------------|-------|------|-------|-----|----|----------------|---------------------|-----|-----|-----|----|------|----------------------|------------------|----------|------|-----------------|------------------|-------------------|---------------|------------|
| Voltage | Model | LL | LM | KB1 | KB2 | KL1 | LL | LM | KB1 | KB2 | KL1 | | LA | LB | LC | LD | LE | LG | LZ | S | Tap x Depth | K | QK | H | B | T | Without brake | With brake |
| 230 | 1K020(H/T)-□S2 | 138 | 94 | 60 | 116 | 116 | 163 | 119 | 60 | 141 | 116 | 55 | 165 | 110 ^{h7} | 130 | 145 | 6 | 12 | 9 | 22 ^{h6} | M5 x 12L | 45 | 41 | 18 | 8 ^{h9} | 7 | 5.2 | 6.7 |
| | 1K520(H/T)-□S2 | 155.5 | 111.5 | 77.5 | 133.5 | 101 | 180.5 | 136.5 | 77.5 | 158.5 | 103 | | | | | | | | | | | | | | | 6.7 | 8.2 | |
| 400 | 40020(F/C)-□S2 | 131.5 | 87.5 | 56.5 | 109.5 | 101 | 158.5 | 114.5 | 53.5 | 136.5 | 103 | | 135 | 95 ^{h7} | 100 | 115 | 3 | 10 | | 19 ^{h6} | | 42 | 15.5 | 6 ^{h9} | 6 | 3.1 | 4.1 | |
| | 60020(F/C)-□S2 | 141 | 97 | 66 | 119 | | 168 | 124 | 63 | 146 | | | | | | | | | | | | | | | | 3.5 | 4.5 | |
| | 1K020(F/C)-□S2 | 138 | 94 | 60 | 116 | 116 | 163 | 119 | 57 | 141 | 118 | | 165 | 110 ^{h7} | 130 | 145 | 6 | 12 | | 22 ^{h6} | | 41 | 18 | 8 ^{h9} | 7 | 5.2 | 6.7 | |
| | 1K520(F/C)-□S2 | 155.5 | 111.5 | 77.5 | 133.5 | | 180.5 | 136.5 | 74.5 | 158.5 | | | | | | | | | | | | | | | | | 6.7 | 8.2 |
| | 2K020(F/C)-□S2 | 173 | 129 | 95 | 151 | | 198 | 154 | 92 | 176 | | | | | | | | | | | | | | | | | 8 | 9.5 |
| | 3K020(F/C)-□S2 | 208 | 164 | 127 | 186 | 118 | 233 | 189 | 127 | 211 | | 65 | | | | | | | | | 24 ^{h6} | M8 x 20L | 55 | 51 | 20 | | 11 | 12.6 |
| | 4K020(F/C)-□S2 | 177 | 133 | 96 | 155 | 140 | 202 | 158 | 96 | 180 | 140 | 70 | 233 | 114.3 ^{h7} | 176 | 200 | 3.2 | 18 | 13.5 | 35 ^{h6} | M12 x 25L | | 50 | 30 | 10 ^{h9} | 8 | 15.5 | 18.7 |
| 5K020(F/C)-□S2 | 196 | 152 | 115 | 174 | | 221 | 177 | 115 | 199 | | | | | | | | | | | | | | | | | 18.6 | 21.8 | |



Type 1500 r/min motors (400 V, 7.5kW)

| Dimensions (mm) | | Without brake | | | | | | | With brake | | | | | | | Approx. mass (kg) | |
|-----------------|------------|---------------|-----|-----|-----|-------|-------|-----|------------|-----|-----|-----|-------|-------|-----|-------------------|------------|
| Voltage | Model | LL | LM | KB1 | KB2 | L1 | L2 | L3 | LL | LM | KB1 | KB2 | L1 | L2 | L3 | Without brake | With brake |
| 400 | 7K515C-□S2 | 312 | 268 | 219 | 290 | 117.5 | 117.5 | 149 | 337 | 293 | 253 | 315 | 117.5 | 152.5 | 183 | 36.4 | 40.4 |



Type 1500 r/min motors (400 V, 11 to 15 kW)

| Dimensions (mm) | | Without brake | | | | | | | With brake | | | | | | | Approx. Mass (kg) | |
|-----------------|-------------|---------------|-----|-----|-----|-------|-------|-----|------------|-----|-----|-----|-------|-------|-----|-------------------|------------|
| Voltage | Model | LL | LM | KB1 | KB2 | L1 | L2 | L3 | LL | LM | KB1 | KB2 | L1 | L2 | L3 | Without brake | With brake |
| 400 | R88M-K□ | | | | | | | | | | | | | | | | |
| | 11K015C-□S2 | 316 | 272 | 232 | 294 | 124.5 | 124.5 | 162 | 364 | 320 | 266 | 342 | 124.5 | 159.5 | 196 | 52.7 | 58.9 |
| | 15K015C-□S2 | 384 | 340 | 300 | 362 | 158.5 | 158.5 | 230 | 432 | 388 | 334 | 410 | 158.5 | 193.5 | 264 | 70.2 | 76.3 |



Type 1000 r/min motors (230 V, 900W/400 V, 900 W to 3 kW)

| Dimensions (mm) | | Without brake | | | | | With brake | | | | | LR | Flange surface | | | | | | | Shaft end dimensions | | | | | Approx. mass (kg) | | | |
|-----------------|----------------|---------------|-------|-------|-------|-----|------------|-------|-------|-------|-----|----|----------------|---------------------|-----|-----|-----|----|------|----------------------|-------------|----|----|----|-------------------|----|---------------|------------|
| Voltage | Model | LL | LM | KB1 | KB2 | KL1 | LL | LM | KB1 | KB2 | KL1 | | LA | LB | LC | LD | LE | LG | LZ | S | Tap x Depth | K | QK | H | B | T | Without brake | With brake |
| 230 | 90010(H/T)-□S2 | 155.5 | 111.5 | 77.5 | 133.5 | 116 | 180.5 | 136.5 | 77.5 | 158.5 | 116 | 70 | 165 | 110 ^{h7} | 130 | 145 | 6 | 12 | 9 | 22 ^{h8} | M5 x 12L | 45 | 41 | 18 | 8 ^{h9} | 7 | 6.7 | 8.2 |
| 400 | 90010(F/C)-□S2 | | | | | | | | 74.5 | | 118 | | | | | | | | | | | | | | | | | |
| | 2K010(F/C)-□S2 | 163.5 | 119.5 | 82.5 | 141.5 | 140 | 188.5 | 144.5 | 82.5 | 166.5 | 140 | 80 | 233 | 114.3 ^{h7} | 176 | 200 | 3.2 | 18 | 13.5 | 35 ^{h8} | M12 x 25L | 55 | 50 | 30 | 10 ^{h9} | 8 | 14 | 17.5 |
| | 3K010(F/C)-□S2 | 209.5 | 165.5 | 128.5 | 187.5 | | 234.5 | 190.5 | 128.5 | 212.5 | | | | | | | | | | | | | | | | 20 | 23.5 | |



Type 1000 r/min motors (400 V, 4.5 kW)

| Dimensions (mm) | | Without brake | | | | | | With brake | | | | | | Approx. mass (kg) | |
|-----------------|-----------------------|---------------|-----|-----|-----|----|----|------------|-----|-----|-----|----|-----|-------------------|------------|
| Voltage | Model | LL | LM | KB1 | KB2 | L1 | L2 | LL | LM | KB1 | KB2 | L1 | L2 | Without brake | With brake |
| 400 | R88M-K□ 4K510C-□S2 | 266 | 222 | 185 | 244 | 98 | 98 | 291 | 247 | 185 | 269 | 98 | 133 | 29.4 | 33.3 |



Type 1000 r/min motors (400 V, 6 kW)

| Dimensions (mm) | | Without brake | | | | | | | With brake | | | | | | Approx. mass (kg) | | |
|-----------------|-----------------------|---------------|-----|-----|-----|-------|-------|-----|------------|-----|-----|-----|-------|-------|-------------------|---------------|------------|
| Voltage | Model | LL | LM | KB1 | KB2 | L1 | L2 | L3 | LL | LM | KB1 | KB2 | L1 | L2 | L3 | Without brake | With brake |
| 400 | R88M-K□ 6K010C-□S2 | 312 | 268 | 219 | 290 | 117.5 | 117.5 | 149 | 337 | 293 | 253 | 315 | 117.5 | 152.5 | 183 | 36.4 | 40.4 |

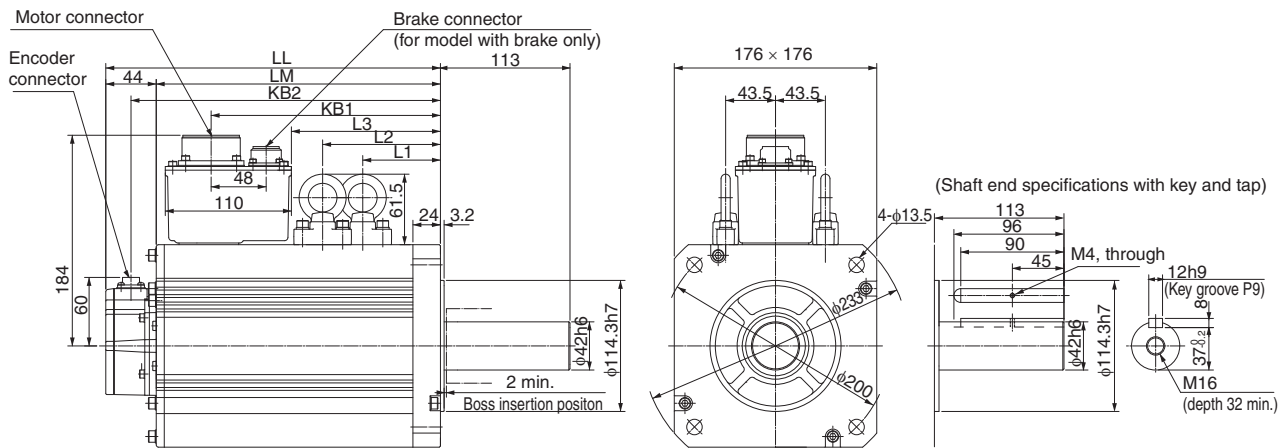

High inertia servo motors

Type 3000 r/min motors (230 V, 200 W to 750 W)

| Dimensions (mm) | | Without brake | | With brake | | KB1 | LR | Flange surface | | | | | Shaft end dimensions | | | | | | Approx. mass (kg) | | |
|-----------------|------------------|---------------|-------|------------|-------|------|----|----------------|------------------|----|-----|-----|----------------------|-------------|----|------|------|-----------------|-------------------|---------------|------------|
| Voltage | Model | L | LL | L | LL | | | LA | LB | LC | LG | LZ | S | Tap x Depth | K | QK | H | B | T | Without brake | With brake |
| 230 | R88M-KH□ | | | | | | | | | | | | | | | | | | | | |
| | 20030(H/T)-□S2-D | 129 | 99 | 165.5 | 135.5 | 42 | 30 | 70 | 50 ^{h7} | 60 | 6.5 | 4.5 | 11 ^{h6} | M4x8L | 20 | 18 | 8.5 | 4 ^{h9} | 4 | 0.96 | 1.4 |
| | 40030(H/T)-□S2-D | 148.5 | 118.5 | 185 | 155 | 61.5 | | | | | | | 14 ^{h6} | M5x10L | 25 | 22.5 | 11 | 5 ^{h9} | 5 | 1.4 | 1.8 |
| | 75030(H/T)-□S2-D | 162.2 | 127.2 | 199.2 | 164.2 | 67.2 | 35 | 90 | 70 ^{h7} | 80 | 8 | 6 | 19 ^{h6} | M5x10L | 25 | 22 | 15.5 | 6 ^{h9} | 6 | 2.5 | 3.3 |



Encoder connector wiring



Cable length 300±30
Connector optional
Made by Hypertac
SRUC-17G-MRWVN040 (MALE)

Power and brake connector wiring

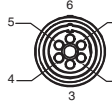

Cable length 300±30
Connector optional
Made by Hypertac
SRUC-06J-MSCN236 (MALE)

| Pin No. | Signal |
|----------------|--------------------|
| 1 | BAT - (0 V) |
| 2 | BAT + |
| 3 | S + |
| 4 | S - |
| 5 to 7 | Free |
| 8 | ESV (power supply) |
| 9 | E0V (power supply) |
| 10 to 17 | Free |
| Connector case | FG (Ground) |

*Note: Pins 1 and 2 used only for motors with ABS encoder.

| Pin No. | Output |
|---------|-----------------|
| 1 | Phase U |
| 2 | Phase V |
| 3 | Phase W |
| 4 | *Brake terminal |
| 5 | *Brake terminal |
| 6 | FG (ground) |

*Note: Pins 4 and 5 used only for motors with brake.

Mating connector:
Plug type: SPOC-06K-FSDN169 (FEMALE)

Mating connector:
Plug type: SPOC-17H-FRON169 (FEMALE)

Type 2000 r/min motors (400 V, 1 kW to 5 kW)

| Dimensions (mm) | | Without brake | | | With brake | | | LR | Flange surface | | | | | | Shaft end dimensions | | | | | Approx. mass (kg) | | | | | | | | |
|-----------------|----------------|---------------|-------|-------|------------|-----|-------|-------|----------------|-------|-----|-----|-----|---------------------|----------------------|-----|-----|----|------|-------------------|----|----|----|------------------|---|---------------|------------|------|
| Voltage | Model | LL | LM | KB1 | KB2 | KL1 | LL | | LM | KB1 | KB2 | KL1 | LA | LB | LC | LD | LE | LG | LZ | S | K | QK | H | B | T | Without brake | With brake | |
| 400 | R88M-KH□ | | | | | | | | | | | | | | | | | | | | | | | | | | | |
| | 1K020(F/C)-□S1 | 173 | 129 | 95 | 151 | 116 | 201 | 157 | 92 | 179 | 118 | 70 | 165 | 110 ^{h7} | 130 | 145 | 6 | 12 | 9 | 22 ^{h6} | 45 | 41 | 18 | 8 ^{h9} | 7 | 6.7 | 8.1 | |
| | 1K520(F/C)-□S1 | 190.5 | 146.5 | 112.5 | 168.5 | | 218.5 | 174.5 | 109.5 | 196.5 | | | | | | | | | | | | | | | | | 8.6 | 10.1 |
| | 2K020(F/C)-□S1 | 177 | 133 | 96 | 155 | 140 | 206 | 162 | 96 | 184 | 140 | 80 | 233 | 114.3 ^{h7} | 176 | 200 | 3.2 | 18 | 13.5 | 35 ^{h6} | 55 | 50 | 30 | 10 ^{h9} | 8 | 12.2 | 15.5 | |
| | 3K020(F/C)-□S1 | 196 | 152 | 115 | 174 | | 225 | 181 | 115 | 203 | | | | | | | | | | | | | | | | | 16.0 | 19.2 |
| | 4K020(F/C)-□S1 | 209.5 | 165.5 | 128.5 | 187.5 | | 238.5 | 194.5 | 128.5 | 216.5 | | | | | | | | | | | | | | | | | | 18.6 |
| | 5K020(F/C)-□S1 | 238.5 | 194.5 | 157.5 | 216.5 | | 267.5 | 223.5 | 157.5 | 245.5 | | | | | | | | | | | | | | | | | 23.0 | 26.2 |



Type 1500 r/min motors (400 V, 7.5 kW)

| Dimensions (mm) | | Without brake | | | | | | | With brake | | | | | | | Approx. mass (kg) | |
|-----------------|------------|---------------|-----|-----|-----|-------|-------|-----|------------|-----|-----|-----|-------|-------|-----|-------------------|------------|
| Voltage | Model | LL | LM | KB1 | KB2 | L1 | L2 | L3 | LL | LM | KB1 | KB2 | L1 | L2 | L3 | Without brake | With brake |
| | R88M-KH□ | | | | | | | | | | | | | | | | |
| 400 | 7K515C-□S1 | 357 | 313 | 264 | 335 | 146.5 | 146.5 | 194 | 382 | 338 | 298 | 360 | 146.5 | 181.5 | 228 | 42.3 | 46.2 |

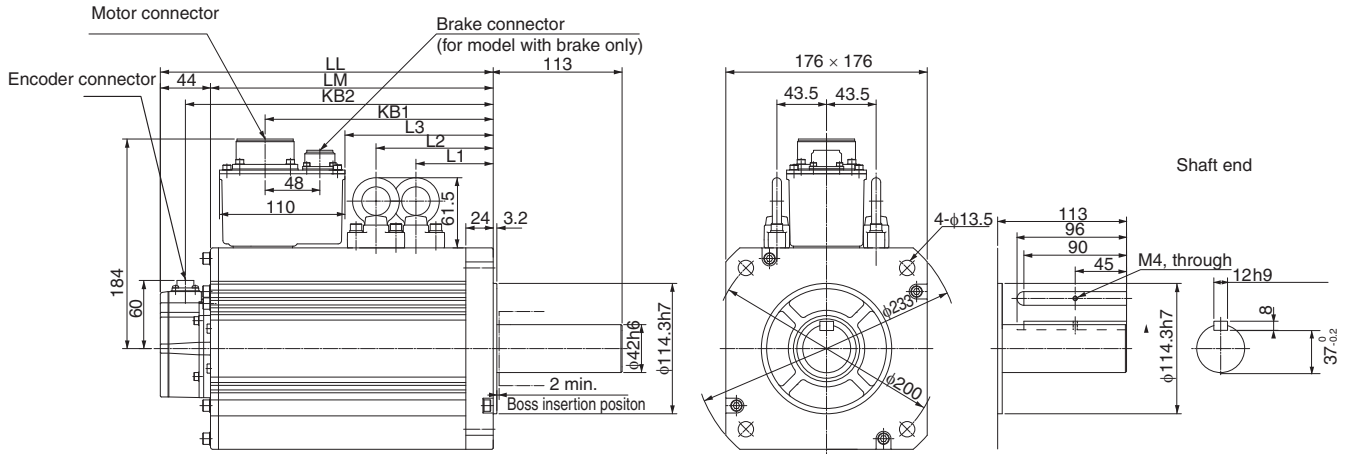

Ordering information

(Refer to servo drive chapter)

② Drive options

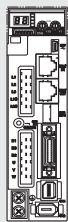

Accurax G5 servo drive
EtherCAT, ML2 and
Analogue/pulse models



④ Extension cable for
absolute encoder
(with battery holder)

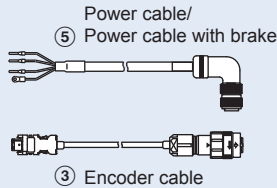
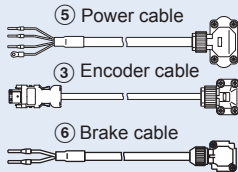

Standard servo motors

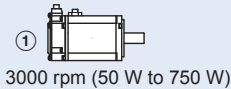

3000 rpm (50 W to 750 W)

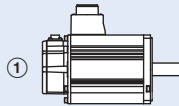

3000 rpm (750 W to 5 kW)
2000 rpm (400 W to 5 kW)
1000 rpm (900 W to 3 kW)

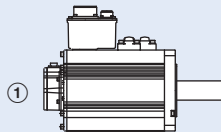

1500 rpm (7.5 kW to 15 kW)
1000 rpm (4.5 kW to 6 kW)

High inertia servo motors

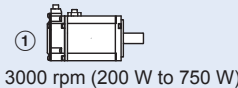
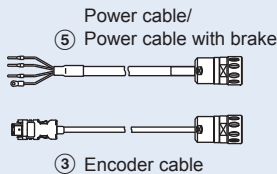

3000 rpm (200 W to 750 W)

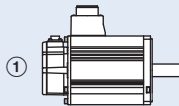
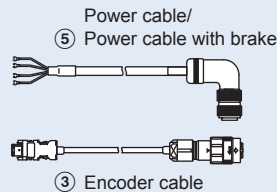

2000 rpm (1 kW to 5 kW)

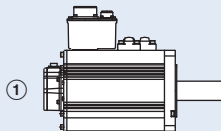

1500 rpm (7.5 kW)

Note: The symbols ①②③... show the recommended sequence to select the servo motor and cables

Servo motor

① Select motor from R88M-K or R88M-KH families using motor tables in next pages.

Servo drive

② Refer to Accurax G5 servo drive chapter for detailed drive specifications and selection of drive accessories.

Standard servo motors

Servo motors 3000 r/min (50 to 5000 W)

| Symbol | Specifications | | | | Servo motor model | Compatible servo drives (2) | | | |
|--|----------------|--|--|---------------|-------------------|-----------------------------|------------------|--------------|------------|
| | Voltage | Encoder and design | Rated torque | Capacity | | G5 EtherCAT/ ML2 | G5 Analog/pulse | | |
| <p>①</p>  <p>230V (50 to 750 W)</p>  <p>230 V (1 kW to 1.5 kW) 400 V (750 W to 5 kW)</p> | 230 V | Incremental encoder (20 bit) Straight shaft with key and tap | Without brake | 0.16 Nm | 50 W | R88M-K05030H-S2 | R88D-KN01H-□ | R88D-KT01H | |
| | | | | 0.32 Nm | 100 W | R88M-K10030H-S2 | R88D-KN01H-□ | R88D-KT01H | |
| | | | | 0.64 Nm | 200 W | R88M-K20030H-S2 | R88D-KN02H-□ | R88D-KT02H | |
| | | | | 1.3 Nm | 400 W | R88M-K40030H-S2 | R88D-KN04H-□ | R88D-KT04H | |
| | | | | 2.4 Nm | 750 W | R88M-K75030H-S2 | R88D-KN08H-□ | R88D-KT08H | |
| | | | | 3.18 Nm | 1000 W | R88M-K1K030H-S2 | R88D-KN15H-□ | R88D-KT15H | |
| | | | 4.77 Nm | 1500 W | R88M-K1K530H-S2 | R88D-KN15H-□ | R88D-KT15H | | |
| | | | With brake | 0.16 Nm | 50 W | R88M-K05030H-BS2 | R88D-KN01H-□ | R88D-KT01H | |
| | | | | 0.32 Nm | 100 W | R88M-K10030H-BS2 | R88D-KN01H-□ | R88D-KT01H | |
| | | | | 0.64 Nm | 200 W | R88M-K20030H-BS2 | R88D-KN02H-□ | R88D-KT02H | |
| | | | | 1.3 Nm | 400 W | R88M-K40030H-BS2 | R88D-KN04H-□ | R88D-KT04H | |
| | | | | 2.4 Nm | 750 W | R88M-K75030H-BS2 | R88D-KN08H-□ | R88D-KT08H | |
| | | 3.18 Nm | | 1000 W | R88M-K1K030H-BS2 | R88D-KN15H-□ | R88D-KT15H | | |
| | | 400 V | Incremental encoder (20 bit) Straight shaft with key and tap | Without brake | 2.39 Nm | 750 W | R88M-K75030F-S2 | R88D-KN10F-□ | R88D-KT10F |
| | | | | | 3.18 Nm | 1000 W | R88M-K1K030F-S2 | R88D-KN15F-□ | R88D-KT15F |
| | | | | | 4.77 Nm | 1500 W | R88M-K1K530F-S2 | R88D-KN15F-□ | R88D-KT15F |
| | | | | | 6.37 Nm | 2000 W | R88M-K2K030F-S2 | R88D-KN20F-□ | R88D-KT20F |
| | | | | | 9.55 Nm | 3000 W | R88M-K3K030F-S2 | R88D-KN30F-□ | R88D-KT30F |
| | | | | | 12.7 Nm | 4000 W | R88M-K4K030F-S2 | R88D-KN50F-□ | R88D-KT50F |
| | | | | With brake | 2.39 Nm | 750 W | R88M-K75030F-BS2 | R88D-KN10F-□ | R88D-KT10F |
| | | | | | 3.18 Nm | 1000 W | R88M-K1K030F-BS2 | R88D-KN15F-□ | R88D-KT15F |
| | | | | | 4.77 Nm | 1500 W | R88M-K1K530F-BS2 | R88D-KN15F-□ | R88D-KT15F |
| | | | | | 6.37 Nm | 2000 W | R88M-K2K030F-BS2 | R88D-KN20F-□ | R88D-KT20F |
| | | | | | 9.55 Nm | 3000 W | R88M-K3K030F-BS2 | R88D-KN30F-□ | R88D-KT30F |
| | 12.7 Nm | | | | 4000 W | R88M-K4K030F-BS2 | R88D-KN50F-□ | R88D-KT50F | |
| | 400 V | Absolute encoder (17 bit) Straight shaft with key and tap | Without brake | 2.39 Nm | 750 W | R88M-K75030C-S2 | R88D-KN10F-□ | R88D-KT10F | |
| | | | | 3.18 Nm | 1000 W | R88M-K1K030C-S2 | R88D-KN15F-□ | R88D-KT15F | |
| | | | | 4.77 Nm | 1500 W | R88M-K1K530C-S2 | R88D-KN15F-□ | R88D-KT15F | |
| | | | | 6.37 Nm | 2000 W | R88M-K2K030C-S2 | R88D-KN20F-□ | R88D-KT20F | |
| | | | | 9.55 Nm | 3000 W | R88M-K3K030C-S2 | R88D-KN30F-□ | R88D-KT30F | |
| | | | | 12.7 Nm | 4000 W | R88M-K4K030C-S2 | R88D-KN50F-□ | R88D-KT50F | |
| | | | With brake | 2.39 Nm | 750 W | R88M-K75030C-BS2 | R88D-KN10F-□ | R88D-KT10F | |
| | | | | 3.18 Nm | 1000 W | R88M-K1K030C-BS2 | R88D-KN15F-□ | R88D-KT15F | |
| | | | | 4.77 Nm | 1500 W | R88M-K1K530C-BS2 | R88D-KN15F-□ | R88D-KT15F | |
| | | | | 6.37 Nm | 2000 W | R88M-K2K030C-BS2 | R88D-KN20F-□ | R88D-KT20F | |
| | | | | 9.55 Nm | 3000 W | R88M-K3K030C-BS2 | R88D-KN30F-□ | R88D-KT30F | |
| | | | | 12.7 Nm | 4000 W | R88M-K4K030C-BS2 | R88D-KN50F-□ | R88D-KT50F | |



Servo motors 2000 r/min (1 to 5 kW)

| Symbol | Specifications | | | | Servo motor model | Compatible servo drives (2) | | | | |
|---|--|---|--|---|-------------------|-----------------------------|------------------|-----------------|-----------------|--------------|
| | Voltage | Encoder and design | Rated torque | Capacity | | G5 EtherCAT/ ML2 | G5 Analog/pulse | | | |
|  | 230 V | Incremental encoder (20 bit) Straight shaft with key and tap | Without brake | 4.77 Nm | 1000 W | R88M-K1K020H-S2 | R88D-KN10H-□ | R88D-KT10H | | |
| | | | | 7.16 Nm | 1500 W | R88M-K1K520H-S2 | R88D-KN15H-□ | R88D-KT15H | | |
| | | | With brake | 4.77 Nm | 1000 W | R88M-K1K020H-BS2 | R88D-KN10H-□ | R88D-KT10H | | |
| | | | | 7.16 Nm | 1500 W | R88M-K1K520H-BS2 | R88D-KN15H-□ | R88D-KT15H | | |
| | | | Absolute encoder (17 bit) Straight shaft with key and tap | Without brake | 4.77 Nm | 1000 W | R88M-K1K020T-S2 | R88D-KN10H-□ | R88D-KT10H | |
| | | | | | 7.16 Nm | 1500 W | R88M-K1K520T-S2 | R88D-KN15H-□ | R88D-KT15H | |
| | | With brake | | 4.77 Nm | 1000 W | R88M-K1K020T-BS2 | R88D-KN10H-□ | R88D-KT10H | | |
| | | | | 7.16 Nm | 1500 W | R88M-K1K520T-BS2 | R88D-KN15H-□ | R88D-KT15H | | |
| | | 400 V | | Incremental encoder (20 bit) Straight shaft with key and tap | Without brake | 1.91 Nm | 400 W | R88M-K40020F-S2 | R88D-KN06F-□ | R88D-KT06F |
| | | | | | | | 2.86 Nm | 600 W | R88M-K60020F-S2 | R88D-KN06F-□ |
| | | | | | | 4.77 Nm | 1000 W | R88M-K1K020F-S2 | R88D-KN10F-□ | R88D-KT10F |
| | | | | | | 7.16 Nm | 1500 W | R88M-K1K520F-S2 | R88D-KN15F-□ | R88D-KT15F |
| | | | 9.55 Nm | | | 2000 W | R88M-K2K020F-S2 | R88D-KN20F-□ | R88D-KT20F | |
| | | | 14.3 Nm | | | 3000 W | R88M-K3K020F-S2 | R88D-KN30F-□ | R88D-KT30F | |
| | With brake | | | | 1.91 Nm | 400 W | R88M-K40020F-BS2 | R88D-KN06F-□ | R88D-KT06F | |
| | | | | | 2.86 Nm | 600 W | R88M-K60020F-BS2 | R88D-KN06F-□ | R88D-KT06F | |
| | | | | | 4.77 Nm | 1000 W | R88M-K1K020F-BS2 | R88D-KN10F-□ | R88D-KT10F | |
| | | | | | 7.16 Nm | 1500 W | R88M-K1K520F-BS2 | R88D-KN15F-□ | R88D-KT15F | |
| | | | | | 9.55 Nm | 2000 W | R88M-K2K020F-BS2 | R88D-KN20F-□ | R88D-KT20F | |
| | | | | | 14.3 Nm | 3000 W | R88M-K3K020F-BS2 | R88D-KN30F-□ | R88D-KT30F | |
| | Absolute encoder (17 bit) Straight shaft with key and tap | Without brake | | | 1.91 Nm | 400 W | R88M-K40020C-S2 | R88D-KN06F-□ | R88D-KT06F | |
| | | | | | 2.86 Nm | 600 W | R88M-K60020C-S2 | R88D-KN06F-□ | R88D-KT06F | |
| | | | | | 4.77 Nm | 1000 W | R88M-K1K020C-S2 | R88D-KN10F-□ | R88D-KT10F | |
| | | | | | 7.16 Nm | 1500 W | R88M-K1K520C-S2 | R88D-KN15F-□ | R88D-KT15F | |
| | | | | | 9.55 Nm | 2000 W | R88M-K2K020C-S2 | R88D-KN20F-□ | R88D-KT20F | |
| | | | | | 14.3 Nm | 3000 W | R88M-K3K020C-S2 | R88D-KN30F-□ | R88D-KT30F | |
| | | With brake | | 1.91 Nm | 400 W | R88M-K40020C-BS2 | R88D-KN06F-□ | R88D-KT06F | | |
| | | | | 2.86 Nm | 600 W | R88M-K60020C-BS2 | R88D-KN06F-□ | R88D-KT06F | | |
| | | | 4.77 Nm | 1000 W | R88M-K1K020C-BS2 | R88D-KN10F-□ | R88D-KT10F | | | |
| | | | 7.16 Nm | 1500 W | R88M-K1K520C-BS2 | R88D-KN15F-□ | R88D-KT15F | | | |
| | | | 9.55 Nm | 2000 W | R88M-K2K020C-BS2 | R88D-KN20F-□ | R88D-KT20F | | | |
| | | | 14.3 Nm | 3000 W | R88M-K3K020C-BS2 | R88D-KN30F-□ | R88D-KT30F | | | |
| | 19.1 Nm | 4000 W | R88M-K4K020C-BS2 | R88D-KN50F-□ | R88D-KT50F | | | | | |
| | 23.9 Nm | 5000 W | R88M-K5K020C-BS2 | R88D-KN50F-□ | R88D-KT50F | | | | | |

Servo motors 1500 r/min (7.5 to 15 kW)

| Symbol | Specifications | | | | Servo motor model | Compatible servo drives (2) | | | |
|---|----------------|--|---------------|----------|-------------------|-----------------------------|-------------------|-----------------|-------------|
| | Voltage | Encoder and design | Rated torque | Capacity | | G5 EtherCAT | G5 Analog/pulse | | |
|  | 400 V | Absolute encoder (17 bit) Straight shaft with key and tap | Without brake | 47.8 Nm | 7500 W | R88M-K7K515C-S2 | R88D-KN75F-ECT | R88D-KT75F | |
| | | | | | 70.0 Nm | 11000 W | R88M-K11K015C-S2 | R88D-KN150F-ECT | R88D-KT150F |
| | | | | | 95.5 Nm | 15000 W | R88M-K15K015C-S2 | R88D-KN150F-ECT | R88D-KT150F |
| | | | With brake | | 47.8 Nm | 7500 W | R88M-K7K515C-BS2 | R88D-KN75F-ECT | R88D-KT75F |
| | | | | | 70.0 Nm | 11000 W | R88M-K11K015C-BS2 | R88D-KN150F-ECT | R88D-KT150F |
| | | | | | 95.5 Nm | 15000 W | R88M-K15K015C-BS2 | R88D-KN150F-ECT | R88D-KT150F |

Servo motors 1000 r/min (900 to 6000 W)

| Symbol | Specifications | | | | Servo motor model | Compatible servo drives (2) | | | |
|--|--|---|---|--------------|-------------------|-----------------------------|------------------|------------------|--------------|
| | Voltage | Encoder and design | Rated torque | Capacity | | G5 EtherCAT/ML2 | G5 Analog/pulse | | |
|  <p>900 W - 3 kW</p>  <p>4.5 kW - 6 kW</p> | 230 V | Incremental encoder (20 bit) Straight shaft with key and tap | No brake | 8.59 Nm | 900 W | R88M-K90010H-S2 | R88D-KN15H-□ | R88D-KT15H | |
| | | | With brake | 8.59 Nm | 900 W | R88M-K90010H-BS2 | R88D-KN15H-□ | R88D-KT15H | |
| | | | Absolute encoder (17 bit) Straight shaft with key and tap | No brake | 8.59 Nm | 900 W | R88M-K90010T-S2 | R88D-KN15H-□ | R88D-KT15H |
| | | | | With brake | 8.59 Nm | 900 W | R88M-K90010T-BS2 | R88D-KN15H-□ | R88D-KT15H |
| | | 400 V | Incremental encoder (20 bit) Straight shaft with key and tap | No brake | 8.59 Nm | 900 W | R88M-K90010F-S2 | R88D-KN15F-□ | R88D-KT15F |
| | | | | | 19.1 Nm | 2000 W | R88M-K2K010F-S2 | R88D-KN30F-□ | R88D-KT30F |
| | | | | | 28.7 Nm | 3000 W | R88M-K3K010F-S2 | R88D-KN50F-□ | R88D-KT50F |
| | | | | | With brake | 8.59 Nm | 900 W | R88M-K90010F-BS2 | R88D-KN15F-□ |
| | 19.1 Nm | | | 2000 W | R88M-K2K010F-BS2 | R88D-KN30F-□ | R88D-KT30F | | |
| | 28.7 Nm | | | 3000 W | R88M-K3K010F-BS2 | R88D-KN50F-□ | R88D-KT50F | | |
| | Absolute encoder (17 bit) Straight shaft with key and tap | | | No brake | 8.59 Nm | 900 W | R88M-K90010C-S2 | R88D-KN15F-□ | R88D-KT15F |
| | | | | | 19.1 Nm | 2000 W | R88M-K2K010C-S2 | R88D-KN30F-□ | R88D-KT30F |
| | | 28.7 Nm | 3000 W | | R88M-K3K010C-S2 | R88D-KN50F-□ | R88D-KT50F | | |
| | | 43.0 Nm | 4500 W | | R88M-K4K510C-S2 | R88D-KN50F-□ | R88D-KT50F | | |
| | 57.3 Nm | 6000 W | R88M-K6K010C-S2 | | R88D-KN75F-ECT | R88D-KT75F | | | |
| | With brake | 8.59 Nm | 900 W | | R88M-K90010C-BS2 | R88D-KN15F-□ | R88D-KT15F | | |
| 19.1 Nm | | 2000 W | R88M-K2K010C-BS2 | | R88D-KN30F-□ | R88D-KT30F | | | |
| 28.7 Nm | | 3000 W | R88M-K3K010C-BS2 | | R88D-KN50F-□ | R88D-KT50F | | | |
| 43.0 Nm | | 4500 W | R88M-K4K510C-BS2 | R88D-KN50F-□ | R88D-KT50F | | | | |
| 57.3 Nm | 6000 W | R88M-K6K010C-BS2 | R88D-KN75F-ECT | R88D-KT75F | | | | | |

High inertia servo motors

Servo motors 3000 r/min (200 to 750 W)

| Symbol | Specifications | | | | Servo motor model | Compatible servo drives (2) | | |
|---|----------------|---|---------------|----------|-------------------|-----------------------------|-----------------|------------|
| | Voltage | Encoder and design | Rated torque | Capacity | | G5 EtherCAT/ ML2 | G5 Analog/pulse | |
|  | 230 V | Incremental encoder (20 bit) Straight shaft with key and tap | Without brake | 0.64 Nm | 200 W | R88M-KH20030H-S2-D | R88D-KN02H-□ | R88D-KT02H |
| | | | | 1.3 Nm | 400 W | R88M-KH40030H-S2-D | R88D-KN04H-□ | R88D-KT04H |
| | | | | 2.4 Nm | 750 W | R88M-KH75030H-S2-D | R88D-KN08H-□ | R88D-KT08H |
| | | | With brake | 0.64 Nm | 200 W | R88M-KH20030H-BS2-D | R88D-KN02H-□ | R88D-KT02H |
| | | | | 1.3 Nm | 400 W | R88M-KH40030H-BS2-D | R88D-KN04H-□ | R88D-KT04H |
| | | | | 2.4 Nm | 750 W | R88M-KH75030H-BS2-D | R88D-KN08H-□ | R88D-KT08H |
| | | Absolute encoder (17 bit) Straight shaft with key and tap | Without brake | 0.64 Nm | 200 W | R88M-KH20030T-S2-D | R88D-KN02H-□ | R88D-KT02H |
| | | | | 1.3 Nm | 400 W | R88M-KH40030T-S2-D | R88D-KN04H-□ | R88D-KT04H |
| | | | | 2.4 Nm | 750 W | R88M-KH75030T-S2-D | R88D-KN08H-□ | R88D-KT08H |
| | | | With brake | 0.64 Nm | 200 W | R88M-KH20030T-BS2-D | R88D-KN02H-□ | R88D-KT02H |
| | | | | 1.3 Nm | 400 W | R88M-KH40030T-BS2-D | R88D-KN04H-□ | R88D-KT04H |
| | | | | 2.4 Nm | 750 W | R88M-KH75030T-BS2-D | R88D-KN08H-□ | R88D-KT08H |

Servo motors 2000 r/min (1 to 5 kW)



| Symbol | Specifications | | | | Servo motor model | Compatible servo drives (2) | | |
|---|----------------|--|---------------|----------|-------------------|-----------------------------|-----------------|------------|
| | Voltage | Encoder and design | Rated torque | Capacity | | G5 EtherCAT/ML2 | G5 Analog/pulse | |
|  | 400 V | Incremental encoder (20 bit) Shaft end with key | Without brake | 4.77 Nm | 1000 W | R88M-KH1K020F-S1 | R88D-KN10F-□ | R88D-KT10F |
| | | | | 7.16 Nm | 1500 W | R88M-KH1K520F-S1 | R88D-KN15F-□ | R88D-KT15F |
| | | | | 9.55 Nm | 2000 W | R88M-KH2K020F-S1 | R88D-KN20F-□ | R88D-KT20F |
| | | | | 14.3 Nm | 3000 W | R88M-KH3K020F-S1 | R88D-KN30F-□ | R88D-KT30F |
| | | | | 19.1 Nm | 4000 W | R88M-KH4K020F-S1 | R88D-KN50F-□ | R88D-KT50F |
| | | | | 23.9 Nm | 5000 W | R88M-KH5K020F-S1 | R88D-KN50F-□ | R88D-KT50F |
| | | | With brake | 4.77 Nm | 1000 W | R88M-KH1K020F-BS1 | R88D-KN10F-□ | R88D-KT10F |
| | | | | 7.16 Nm | 1500 W | R88M-KH1K520F-BS1 | R88D-KN15F-□ | R88D-KT15F |
| | | | | 9.55 Nm | 2000 W | R88M-KH2K020F-BS1 | R88D-KN20F-□ | R88D-KT20F |
| | | | | 14.3 Nm | 3000 W | R88M-KH3K020F-BS1 | R88D-KN30F-□ | R88D-KT30F |
| | | | | 19.1 Nm | 4000 W | R88M-KH4K020F-BS1 | R88D-KN50F-□ | R88D-KT50F |
| | | | | 23.9 Nm | 5000 W | R88M-KH5K020F-BS1 | R88D-KN50F-□ | R88D-KT50F |
| | | Absolute encoder (17 bit) Shaft end with key | Without brake | 4.77 Nm | 1000 W | R88M-KH1K020C-S1 | R88D-KN10F-□ | R88D-KT10F |
| | | | | 7.16 Nm | 1500 W | R88M-KH1K520C-S1 | R88D-KN15F-□ | R88D-KT15F |
| | | | | 9.55 Nm | 2000 W | R88M-KH2K020C-S1 | R88D-KN20F-□ | R88D-KT20F |
| | | | | 14.3 Nm | 3000 W | R88M-KH3K020C-S1 | R88D-KN30F-□ | R88D-KT30F |
| | | | | 19.1 Nm | 4000 W | R88M-KH4K020C-S1 | R88D-KN50F-□ | R88D-KT50F |
| | | | | 23.9 Nm | 5000 W | R88M-KH5K020C-S1 | R88D-KN50F-□ | R88D-KT50F |
| | | | With brake | 4.77 Nm | 1000 W | R88M-KH1K020C-BS1 | R88D-KN10F-□ | R88D-KT10F |
| | | | | 7.16 Nm | 1500 W | R88M-KH1K520C-BS1 | R88D-KN15F-□ | R88D-KT15F |
| | | | | 9.55 Nm | 2000 W | R88M-KH2K020C-BS1 | R88D-KN20F-□ | R88D-KT20F |
| | | | | 14.3 Nm | 3000 W | R88M-KH3K020C-BS1 | R88D-KN30F-□ | R88D-KT30F |
| | | | | 19.1 Nm | 4000 W | R88M-KH4K020C-BS1 | R88D-KN50F-□ | R88D-KT50F |
| | | | | 23.9 Nm | 5000 W | R88M-KH5K020C-BS1 | R88D-KN50F-□ | R88D-KT50F |

Servo motors 1500 r/min (7.5 kW)

| Symbol | Specifications | | | | Servo motor model | Compatible servo drives (2) | | |
|---|----------------|---|---------------|--------------|-------------------|-----------------------------|----------------|-----------------|
| | Voltage | Encoder and design | | Rated torque | | Capacity | G5 EtherCAT | G5 Analog/pulse |
|  | 400 V | Absolute encoder (17 bit) Shaft end with key | Without brake | 47.8 Nm | 7500 W | R88M-KH7K515C-S1 | R88D-KN75F-ECT | R88D-KT75F |
| | | | With brake | 47.8 Nm | 7500 W | R88M-KH7K515C-BS1 | R88D-KN75F-ECT | R88D-KT75F |

Encoder cables

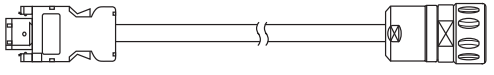
For absolute and incremental encoders

| Symbol | Specifications | Model | Appearance |
|-----------------------|---|--------------------------|--|
| ③ | Encoder cable for servomotors R88M-K(050/100/200/400/750)30(H/T)□ | 1.5 m R88A-CRKA001-5CR-E |  |
| | | 3 m R88A-CRKA003CR-E | |
| | | 5 m R88A-CRKA005CR-E | |
| | | 10 m R88A-CRKA010CR-E | |
| | | 15 m R88A-CRKA015CR-E | |
| | Encoder cable for servomotors R88M-KH(200/400/750)30(H/T)□ | 3 m R88A-CRWA003C-DE |  |
| | | 5 m R88A-CRWA005C-DE | |
| | | 10 m R88A-CRWA010C-DE | |
| | | 15 m R88A-CRWA015C-DE | |
| | Encoder cable for servomotors R88M-K(1K0/1K5)30(H/T)□ R88M-K(750/1K0/1K5/2K0/3K0/4K0/5K0)30(F/C)□ R88M-K(400/600/1K0/1K5/2K0/3K0/4K0/5K0)20□ R88M-K(7K5/11K0/15K0)15□ R88M-K(900/2K0/3K0/4K5/6K0)10□ R88M-KH(1K0/1K5/2K0/3K0/4K0/5K0)20(F/C)□ R88M-KH7K515C□ | 1.5 m R88A-CRKC001-5NR-E |  |
| 3 m R88A-CRKC003NR-E | | | |
| 5 m R88A-CRKC005NR-E | | | |
| 10 m R88A-CRKC010NR-E | | | |
| 15 m R88A-CRKC015NR-E | | | |
| 20 m R88A-CRKC020NR-E | | | |

Note: For servomotors fitted with an absolute encoder you have to add the extension battery cable R88A-CRGD0R3C□ (see below) or connect a backup battery in the CN1 I/O connector.

Absolute encoder battery cable (encoder extension cable only)

| Symbol | Specifications | Model | Appearance |
|--------|---|--|---|
| ④ | Absolute encoder battery cable | Battery not included 0.3 m R88A-CRGD0R3C-E |  |
| | | Battery included 0.3 m R88A-CRGD0R3C-BS-E | |
| | Absolute encoder backup battery 2,000 mA.h 3.6V | R88A-BAT01G |  |

Power cables

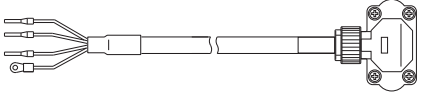
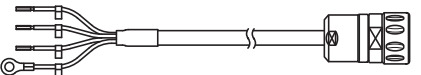
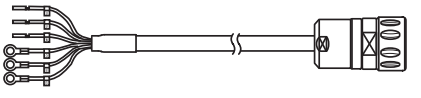
| Symbol | Specifications | Model | Appearance | |
|--------|--|----------------------------------|--------------------------|---|
| ⑤ | For 200 V servomotors R88M-K(050/100/200/400/750)30(H/T)-□□S2 Note: for servomotors with brake R88M-K(050/100/200/400/750)30(H/T)-BS2, the separate brake cable R88A-CAKA□□□BR-E is needed | Power cable only (without brake) | 1.5 m R88A-CAKA001-5SR-E |  |
| | | | 3 m R88A-CAKA003SR-E | |
| | | | 5 m R88A-CAKA005SR-E | |
| | | | 10 m R88A-CAKA010SR-E | |
| | | | 15 m R88A-CAKA015SR-E | |
| | | | 20 m R88A-CAKA020SR-E | |
| | For 200 V servomotors R88M-KH(200/400/750)30(H/T)-□□S2 | without brake | 3 m R88A-CAWA003S-DE |  |
| | | | 5 m R88A-CAWA005S-DE | |
| | | | 10 m R88A-CAWA010S-DE | |
| | | with brake | 3 m R88A-CAWA003B-DE |  |
| | | | 5 m R88A-CAWA005B-DE | |
| | | | 10 m R88A-CAWA010B-DE | |
| | 15 m R88A-CAWA015B-DE | | | |
| | 20 m R88A-CAWA020B-DE | | | |

| Symbol | Specifications | | Model | Appearance | |
|---|--|------------------|--------------------|--------------------|--|
| ⑤ | For 200 V servomotors R88M-K(1K0/1K5)30(H/T)-□□S2 R88M-K(1K0/1K5)20(H/T)-□□S2 R88M-K90010(H/T)-□□S2 | without brake | 1.5 m | R88A-CAGB001-5SR-E | |
| | | | 3 m | R88A-CAGB003SR-E | |
| | | | 5 m | R88A-CAGB005SR-E | |
| | | | 10 m | R88A-CAGB010SR-E | |
| | | | 15 m | R88A-CAGB015SR-E | |
| | | 20 m | R88A-CAGB020SR-E | | |
| | | with brake | 1.5 m | R88A-CAGB001-5BR-E | |
| | | | 3 m | R88A-CAGB003BR-E | |
| | | | 5 m | R88A-CAGB005BR-E | |
| | | | 10 m | R88A-CAGB010BR-E | |
| | 15 m | | R88A-CAGB015BR-E | | |
| | 20 m | R88A-CAGB020BR-E | | | |
| | For 400 V servomotors R88M-K(750/1K0/1K5/2K0)30(F/C)-□□S2 R88M-K(400/600/1K0/1K5/2K0)20(F/C)-□□S2 R88M-K90010(F/C)-□□S2 R88M-KH(1K0/1K5)20(F/C)-□□S1 | without brake | 1.5 m | R88A-CAGB001-5SR-E | |
| | | | 3 m | R88A-CAGB003SR-E | |
| | | | 5 m | R88A-CAGB005SR-E | |
| | | | 10 m | R88A-CAGB010SR-E | |
| | | | 15 m | R88A-CAGB015SR-E | |
| | | 20 m | R88A-CAGB020SR-E | | |
| | | with brake | 1.5 m | R88A-CAKF001-5BR-E | |
| | | | 3 m | R88A-CAKF003BR-E | |
| 5 m | | | R88A-CAKF005BR-E | | |
| 10 m | | | R88A-CAKF010BR-E | | |
| 15 m | R88A-CAKF015BR-E | | | | |
| 20 m | R88A-CAKF020BR-E | | | | |
| For 400 V servomotors R88M-KH2K020(F/C)-□□S1 | without brake | 1.5 m | R88A-CAKC001-5SR-E | | |
| | | 3 m | R88A-CAKC003SR-E | | |
| | | 5 m | R88A-CAKC005SR-E | | |
| | | 10 m | R88A-CAKC010SR-E | | |
| | | 15 m | R88A-CAKC015SR-E | | |
| | 20 m | R88A-CAKC020SR-E | | | |
| | with brake | 1.5 m | R88A-CAKF001-5BR-E | | |
| | | 3 m | R88A-CAKF003BR-E | | |
| | | 5 m | R88A-CAKF005BR-E | | |
| | | 10 m | R88A-CAKF010BR-E | | |
| 15 m | | R88A-CAKF015BR-E | | | |
| 20 m | R88A-CAKF020BR-E | | | | |
| For 400 V servomotors R88M-K(3K0/4K0/5K0)30(F/C)-□□S2 R88M-K(3K0/4K0/5K0)20(F/C)-□□S2 R88M-K(2K0/3K0)10(F/C)-□□S2 R88M-K4K510C-□□S2 R88M-KH(3K0/4K0/5K0)20(F/C)-□□S1 | without brake | 1.5 m | R88A-CAGD001-5SR-E | | |
| | | 3 m | R88A-CAGD003SR-E | | |
| | | 5 m | R88A-CAGD005SR-E | | |
| | | 10 m | R88A-CAGD010SR-E | | |
| | | 15 m | R88A-CAGD015SR-E | | |
| | 20 m | R88A-CAGD020SR-E | | | |
| | with brake | 1.5 m | R88A-CAGD001-5BR-E | | |
| | | 3 m | R88A-CAGD003BR-E | | |
| | | 5 m | R88A-CAGD005BR-E | | |
| | | 10 m | R88A-CAGD010BR-E | | |
| 15 m | | R88A-CAGD015BR-E | | | |
| 20 m | R88A-CAGD020BR-E | | | | |
| For 400 V servomotors R88M-K6K010C-□□S2 R88M-K7K515C-□□S2 R88M-KH7K515C-□□S1 Note: for servomotors with brake R88M-K(6K010/7K515)C-BS2 and R88M-KH7K515C-BS1 the separate brake cable R88A-CAGE□□BR-E is needed | Power cable only (without brake) | 1.5 m | R88A-CAKE001-5SR-E | | |
| | | 3 m | R88A-CAKE003SR-E | | |
| | | 5 m | R88A-CAKE005SR-E | | |
| | | 10 m | R88A-CAKE010SR-E | | |
| | | 15 m | R88A-CAKE015SR-E | | |
| | | 20 m | R88A-CAKE020SR-E | | |
| For 400 V servomotors R88M-K(11K0/15K0)15C-□□S2 Note: for servomotors with brake R88M-K(11K0/15K0)15C-BS2, the separate brake cable R88A-CAGE□□BR-E is needed | Power cable only (without brake) | 1.5 m | R88A-CAKG001-5SR-E | | |
| | | 3 m | R88A-CAKG003SR-E | | |
| | | 5 m | R88A-CAKG005SR-E | | |
| | | 10 m | R88A-CAKG010SR-E | | |
| | | 15 m | R88A-CAKG015SR-E | | |
| | | 20 m | R88A-CAKG020SR-E | | |

Brake cables (for 200 V 50 to 750 W servo motors and 400 V 6 to 15 kW servo motors)

| Symbol | Specifications | Model | Appearance | |
|--------|---|------------------|--------------------|--|
| ⑥ | Brake cable only. For 200 V servo motors with brake R88M-K(050/100/200/400/750)30(H/T)-BS2 | 1.5 m | R88A-CAKA001-5BR-E | |
| | | 3 m | R88A-CAKA003BR-E | |
| | | 5 m | R88A-CAKA005BR-E | |
| | | 10 m | R88A-CAKA010BR-E | |
| | | 15 m | R88A-CAKA015BR-E | |
| | 20 m | R88A-CAKA020BR-E | | |
| | Brake cable only. For 400 V servo motors with brake R88M-K6K010C-BS2 R88M-K(7K5/11K0/15K0)15C-BS2 R88M-KH7K515C-BS1 | 1.5 m | R88A-CAGE001-5BR-E | |
| | | 3 m | R88A-CAGE003BR-E | |
| | | 5 m | R88A-CAGE005BR-E | |
| | | 10 m | R88A-CAGE010BR-E | |
| 15 m | | R88A-CAGE015BR-E | | |
| 20 m | R88A-CAGE020BR-E | | | |

Connectors for encoder, power and brake cables

| Specifications | | Applicable Servomotor | Model |
|--------------------------------------|------------------|---|------------------|
| Connectors for making encoder cables | Drive side (CN2) | All models | R88A-CNW01R |
| | Motor side | R88M-K(050/100/200/400/750)30(H/T)□ | R88A-CNK02R |
| | Motor side | R88M-KH(200/400/750)□ | SPOC-17H-FRON169 |
| | Motor side | R88M-K(1K0/1K5)30(H/T)□ R88M-K(750/1K0/1K5/2K0/3K0/4K0/5K0)30(F/C)□ R88M-K(400/600/1K0/1K5/2K0/3K0/4K0/5K0)20□ R88M-K(900/2K0/3K0)10□ R88M-K(4K5/6K0)10C-□ R88M-K(7K5/11K0/15K0)15C-□ R88M-KH(1K0/1K5/2K0/3K0/4K0/5K0/7K5)□ | R88A-CNK04R |
| | Motor side | R88M-K(050/100/200/400/750)30(H/T)□ | R88A-CNK11A |
| Connectors for making power cables | Motor side | R88M-KH(200/400/750)30(H/T)□ | SPOC-06K-FSDN169 |
| | Motor side | R88M-K(1K0/1K5)30(H/T)-S2 R88M-K(1K0/1K5)20(H/T)-S2 R88M-K90010(H/T)-S2 R88M-K(750/1K0/1K5/2K0)30(F/C)-S2, R88M-K(400/600/1K0/1K5/2K0)20(F/C)-S2 R88M-K90010(F/C)-S2 R88M-KH(1K0/1K5)20(F/C)-S1 | MS3108E20-4S |
| | Motor side | R88M-K(1K0/1K5)30(H/T)-BS2 R88M-K(1K0/1K5)20(H/T)-BS2 R88M-K90010(H/T)-BS2 | MS3108E20-18S |
| | Motor side | R88M-K(750/1K0/1K5/2K0/3K0/4K0/5K0)30(F/C)-BS2 R88M-K(400/600/1K0/1K5/2K0/3K0/4K0/5K0)20(F/C)-BS2 R88M-K(900/2K0/3K0)10(F/C)-BS2 R88M-K4K510C-BS2 R88M-KH(1K0/1K5/2K0/3K0/4K0/5K0)20(F/C)-BS1 | MS3108E24-11S |
| | Motor side | R88M-K(3K0/4K0/5K0)30(F/C)-S2 R88M-K(3K0/4K0/5K0)20(F/C)-S2 R88M-K(2K0/3K0)10(F/C)-S2 R88M-K4K510C-S2 R88M-KH(2K0/3K0/4K0/5K0)20(F/C)-S1 | MS3108E22-22S |
| | Motor side | R88M-K6K010C-□ R88M-K(7K5/11K0/15K0)15C-□ R88M-KH7K515C-□S1 | MS3108E32-17S |
| | Motor side | R88M-K(050/100/200/400/750)30(H/T)-BS2 | R88A-CNK11B |
| | Motor side | R88M-K6K010C-BS2 R88M-K(7K5/11K0/15K0)15C-BS2 R88M-KH7K515C-BS1 | MS3108E14S-2S |

- Note:** 1. All cables listed are flexible and shielded (except the R88A-CAKA□□□-BR-E which is only a flexible cable).
 2. All connectors and cables listed have IP67 class (except R88A-CNW01R connector and R88A-CRGD0R3C cable).

ALL DIMENSIONS SHOWN ARE IN MILLIMETERS.
To convert millimeters into inches, multiply by 0.03937. To convert grams into ounces, multiply by 0.03527.