

## BiCMOS MMIC MIXER W/ INTEGRATED LO AMPLIFIER, 3.1 - 3.9 GHz



### Typical Applications

The HMC666LP4(E) is Ideal for:

- WiMAX/4G & Fixed Wireless
- Infrastructure & Repeaters
- Transmitters & Receivers
- Test & Measurement Equipment

### Features

- High Input IP3: +31 dBm
- Low Conversion Loss: 9 dB
- Low LO Drive: 0 dBm
- Upconversion & Downconversion Applications
- Optimized for low side LO input
- 24 Lead 4x4mm SMT Package: 16mm<sup>2</sup>

### Functional Diagram

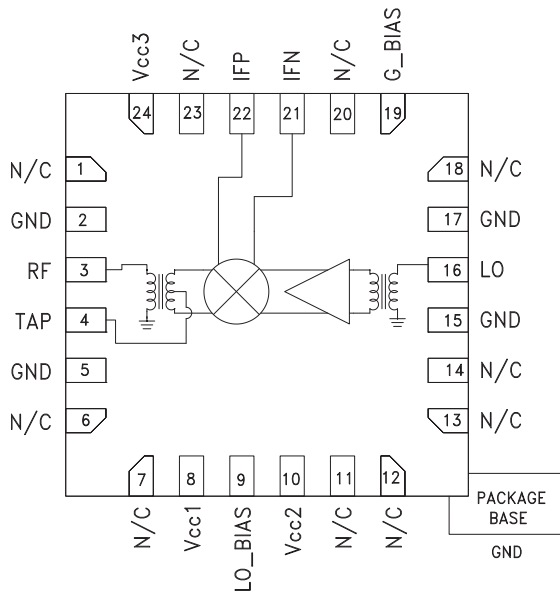

### General Description

The HMC666LP4(E) is a high dynamic range passive MMIC mixer with integrated LO amplifier in a 4x4 SMT QFN package covering 3.1 - 3.9 GHz. Excellent input IP3 performance of +31 dBm for down conversion is provided for WiMAX and fixed wireless applications at an LO drive of 0 dBm. The LO port is optimized for low side LO applications. With an input 1 dB compression of +23 dBm, the RF port will accept a wide range of input signal levels. Conversion loss is 9 dB typical. The DC to 800 MHz IF frequency response will satisfy WiMAX transmit or receive frequency plans. The HMC666LP4(E) is pin for pin compatible with the HMC688LP4(E) which is a 2.0 - 2.7 GHz mixer with LO amplifier.

### Electrical Specifications,

$T_A = +25^\circ C$ ,  $IF = 300 MHz$ ,  $LO = 0 dBm$ ,  $V_{cc} = V_{cc1, 2, 3} = +5V$ ,  $G_{Bias} = +2.5V$

Parameter	Min.	Typ.	Max.	Units
Frequency Range, RF		3.1 - 3.9		GHz
Frequency Range, LO		2.8 - 3.6		GHz
Frequency Range, IF		DC - 800		MHz
Conversion Loss		9	12	dB
Noise Figure (SSB)		9		dB
LO to RF Isolation	21	27		dB
LO to IF Isolation	22	29		dB
RF to IF Isolation	34	42		dB
IP3 (Input)		31		dBm
1 dB Compression (Input)		23		dBm
LO Drive Input Level (Typical)		-3 to +3		dBm
Supply Current I <sub>cc</sub> total		162	195	mA

\* Unless otherwise noted all measurements performed as downconverter with low side LO & IF = 300 MHz.



**Conversion Gain vs. Temperature**

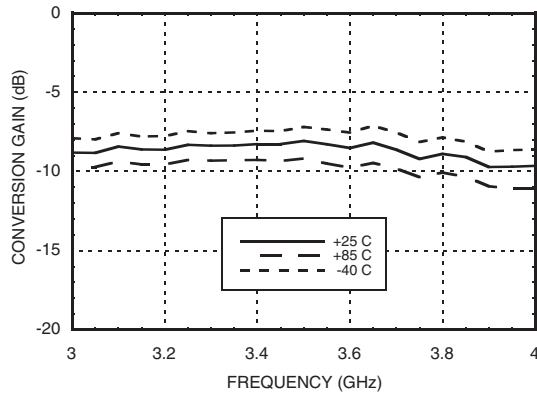

**Isolation**

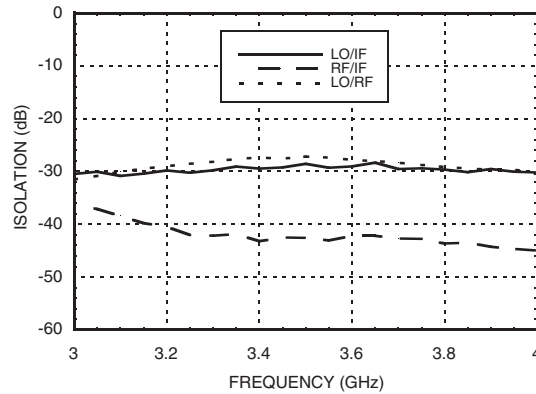

**Conversion Gain vs. LO Drive**

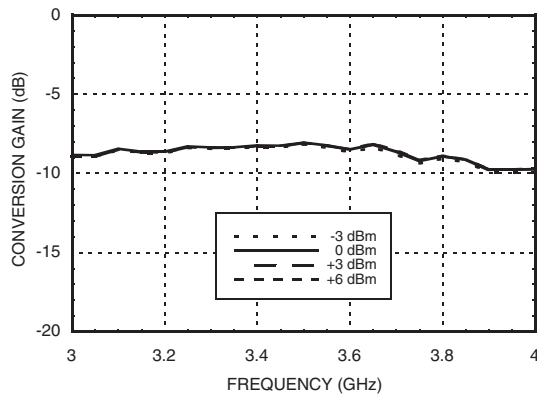

**Return Loss**

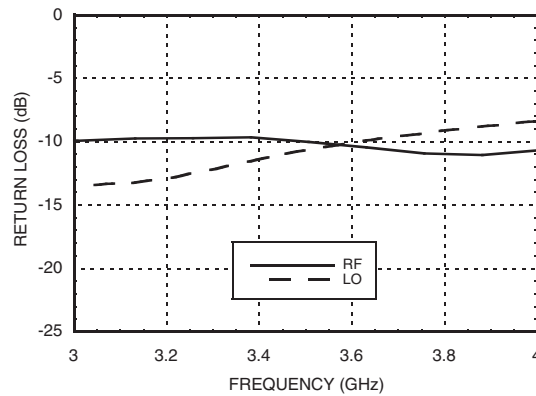

**IF Bandwidth (LO= 3.2 GHz)**

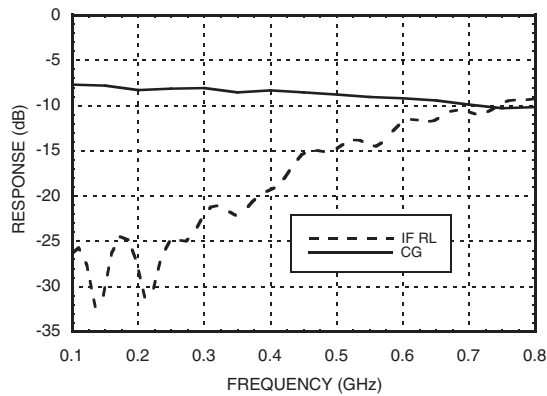

**Input P1dB vs. Temperature**

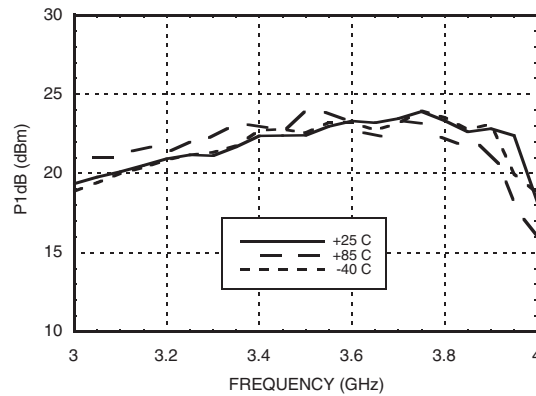

Information furnished by Analog Devices is believed to be accurate and reliable. However, no responsibility is assumed by Analog Devices for its use, nor for any infringements of patents or other rights of third parties that may result from its use. Specifications subject to change without notice. No license is granted by implication or otherwise under any patent or patent rights of Analog Devices. Trademarks and registered trademarks are the property of their respective owners.

For price, delivery, and to place orders: Analog Devices, Inc., One Technology Way, P.O. Box 9106, Norwood, MA 02062-9106 Phone: 781-329-4700 • Order online at [www.analog.com](http://www.analog.com) Application Support: Phone: 1-800-ANALOG-D



**BiCMOS MMIC MIXER W/ INTEGRATED LO AMPLIFIER, 3.1 - 3.9 GHz**

**Input IP3 vs. LO Drive <sup>[1]</sup>**

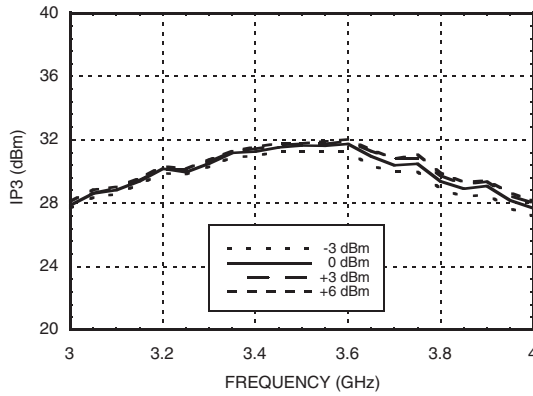

**Input IP3 vs. Temperature <sup>[1]</sup>**

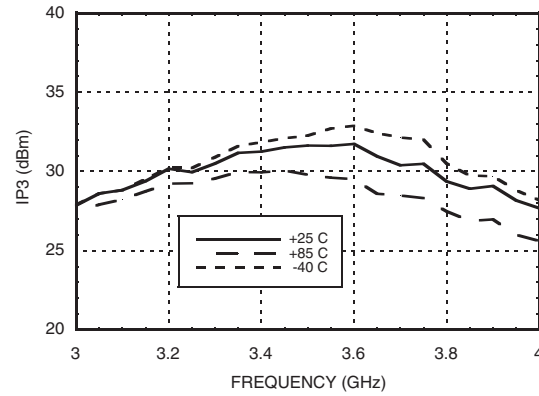

**+2RF -2LO Response vs. Temperature <sup>[2]</sup>**

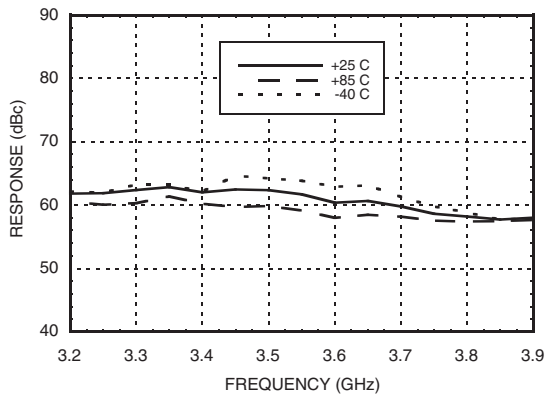

**+2RF -2LO Response vs. LO Drive <sup>[2]</sup>**

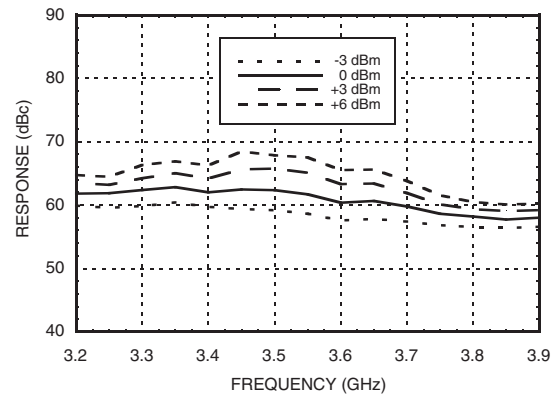

**+3RF -3LO Response vs. Temperature <sup>[2]</sup>**

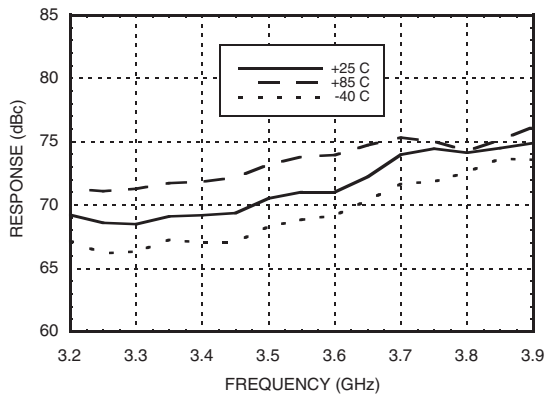

**+3RF -3LO Response vs. LO Drive <sup>[2]</sup>**

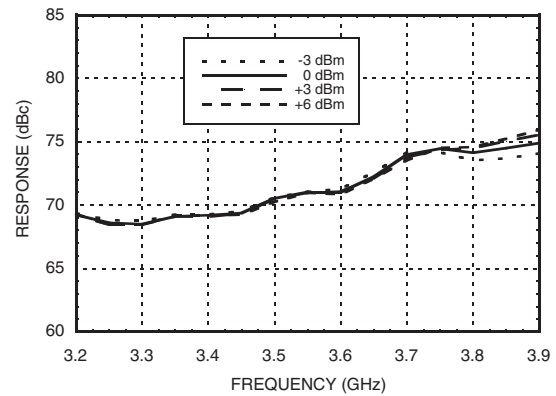

[1] Two-tone input power = +10 dBm each tone, 1 MHz spacing. [2] Referenced to RF Input Power at 0 dBm.

## BiCMOS MMIC MIXER W/ INTEGRATED LO AMPLIFIER, 3.1 - 3.9 GHz



### Upconverter Performance Conversion Gain vs. LO Drive

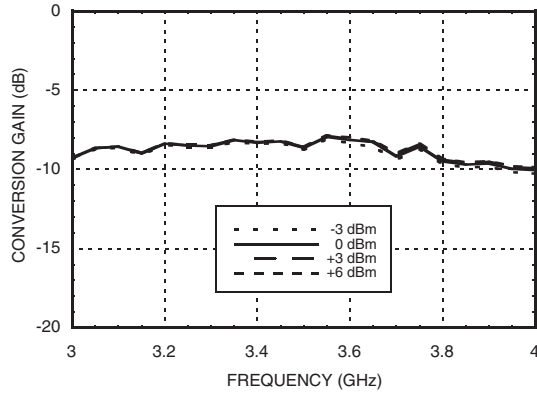

### Upconverter Performance Input IP3 vs. LO Drive <sup>[1]</sup>

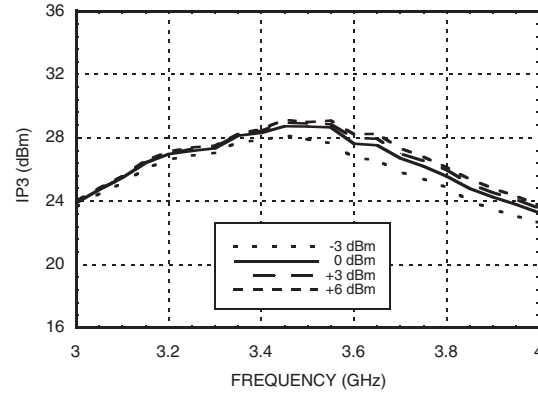

### Absolute Maximum Ratings

RF / IF Input (Vcc1, 2, 3 = +5V)	+23 dBm
LO Drive (Vcc1, 2, 3 = +5V)	+10 dBm
Vcc1, 2, 3	5.5V
Channel Temperature	125 °C
Continuous P <sub>diss</sub> (T = 85°C) (derate 36.23 mW/°C above 85°C)	1.45 W
Thermal Resistance (channel to ground paddle)	27.6 °C/W
Storage Temperature	-65 to 150 °C
Operating Temperature	-40 to +85 °C

### MxN Spurious @ IF Port

mRF	nLO				
	0	1	2	3	4
0	xx	22	31	35	51
1	35	0	44	35	69
2	85	69	57	68	81
3	105	85	91	67	85
4	120	120	120	113	108

RF Freq. = 3.5 GHz @ 0 dBm  
LO Freq. = 3.2 GHz @ 0 dBm  
All values in dBc below IF power level (1RF - 1LO).



ELECTROSTATIC SENSITIVE DEVICE  
OBSERVE HANDLING PRECAUTIONS

### Typical Supply Current vs. Vcc

Vcc1, 2, 3 (V)	I <sub>cc</sub> total (mA)
4.75	149
5.00	162
5.25	174

Downconverter will operate over full voltage range shown above.

### Harmonics of LO

LO Freq. (GHz)	nLO Spur @ RF Port			
	1	2	3	4
2.7	31	33	46	55
2.8	30	30	46	60
2.9	28	30	47	59
3.0	28	29	48	55
3.1	27	28	48	53
3.2	27	29	48	70
3.3	27	30	51	58
3.4	28	31	56	52
3.5	28	33	55	48
3.6	29	34	57	45
3.7	30	35	58	46

LO = 0 dBm  
All values in dBc below input LO level measured at RF port.

Information furnished by Analog Devices is believed to be accurate and reliable. However, no responsibility is assumed by Analog Devices for its use, nor for any infringements of patents or other rights of third parties that may result from its use. Specifications subject to change without notice. No license is granted by implication or otherwise under any patent or patent rights of Analog Devices. Trademarks and registered trademarks are the property of their respective owners.

For price, delivery, and to place orders: Analog Devices, Inc., One Technology Way, P.O. Box 9106, Norwood, MA 02062-9106  
Phone: 781-329-4700 • Order online at [www.analog.com](http://www.analog.com)  
Application Support: Phone: 1-800-ANALOG-D

## BiCMOS MMIC MIXER W/ INTEGRATED LO AMPLIFIER, 3.1 - 3.9 GHz



### Outline Drawing

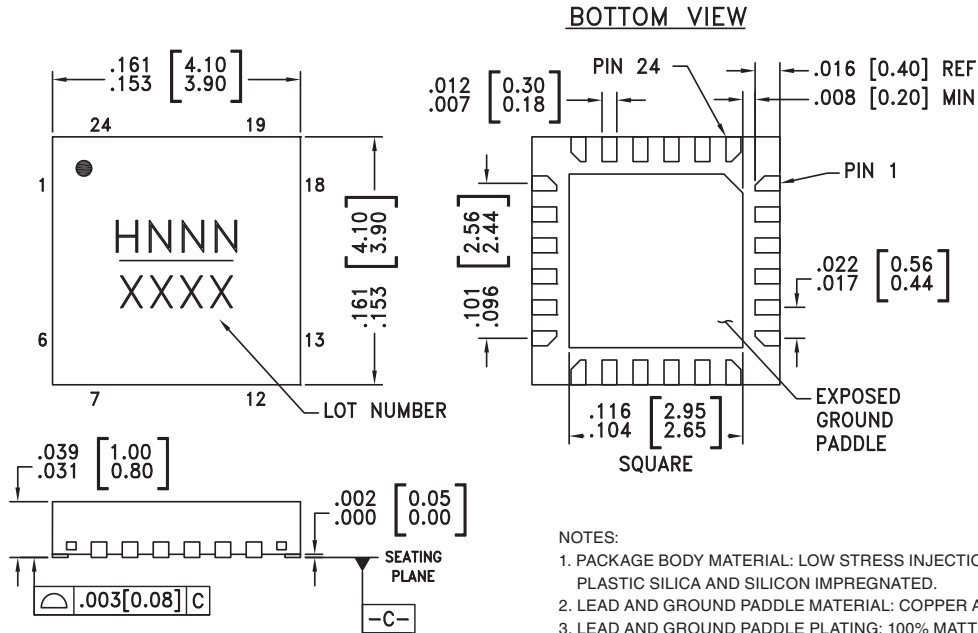

**NOTES:**

1. PACKAGE BODY MATERIAL: LOW STRESS INJECTION MOLDED PLASTIC SILICA AND SILICON IMPREGNATED.
2. LEAD AND GROUND PADDLE MATERIAL: COPPER ALLOY.
3. LEAD AND GROUND PADDLE PLATING: 100% MATTE TIN.
4. DIMENSIONS ARE IN INCHES [MILLIMETERS].
5. LEAD SPACING TOLERANCE IS NON-CUMULATIVE.
6. PAD BURR LENGTH SHALL BE 0.15mm MAX.  
PAD BURR HEIGHT SHALL BE 0.25mm MAX.
7. PACKAGE WARP SHALL NOT EXCEED 0.05mm
8. ALL GROUND LEADS AND GROUND PADDLE MUST BE SOLDERED TO PCB RF GROUND.
9. REFER TO HITTITE APPLICATION NOTE FOR SUGGESTED PCB LAND PATTERN.

### Package Information

Part Number	Package Body Material	Lead Finish	MSL Rating	Package Marking [3]
HMC666LP4	Low Stress Injection Molded Plastic	Sn/Pb Solder	MSL1 [1]	H666 XXXX
HMC666LP4E	RoHS-compliant Low Stress Injection Molded Plastic	100% matte Sn	MSL1 [2]	H666 XXXX

[1] Max peak reflow temperature of 235 °C  
 [2] Max peak reflow temperature of 260 °C  
 [3] 4-Digit lot number XXXX

**Pin Descriptions**

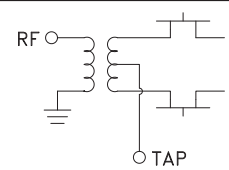
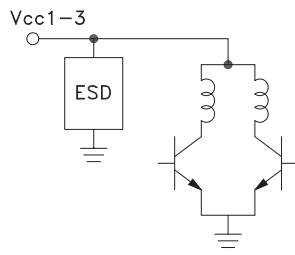
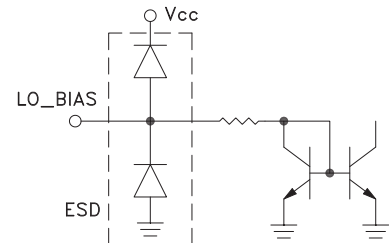
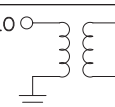
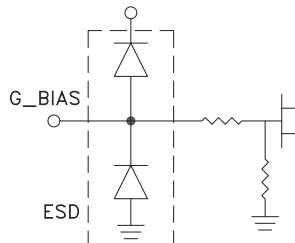
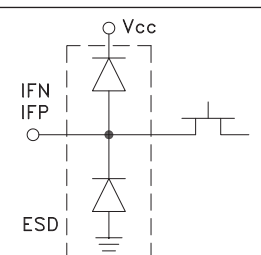
Pin Number	Function	Description	Interface Schematic
1, 6, 7, 11 - 14, 18, 20, 23	N/C	No connection. These pins may be connected to RF ground. Performance will not be affected.	
2, 5, 15, 17	GND	Package bottom must be connected to RF/DC ground.	
3	RF	This pin is matched single-ended 50 Ohm and DC shorted to ground through a balun.	
4	TAP	Short to ground with a zero ohm resistor close to the IC.	
8, 10, 24	Vcc1, Vcc2, Vcc3	Power supply voltage. See application circuit for required external components.	
9	LO_BIAS	Adjust the LO buffer current through an external resistor. See application circuit for required external components.	
16	LO	This pin is matched single-ended 50 Ohm and DC shorted to ground through a balun.	
19	G_BIAS	External optional bias. See application circuit for required external components. Apply +2.5V for nominal performance.	
21, 22	IFN, IFP	Differential IF input / output pins matched to differential 50 Ohms. For applications not requiring operation to DC an off chip DC blocking capacitor should be used.	



**Evaluation PCB**

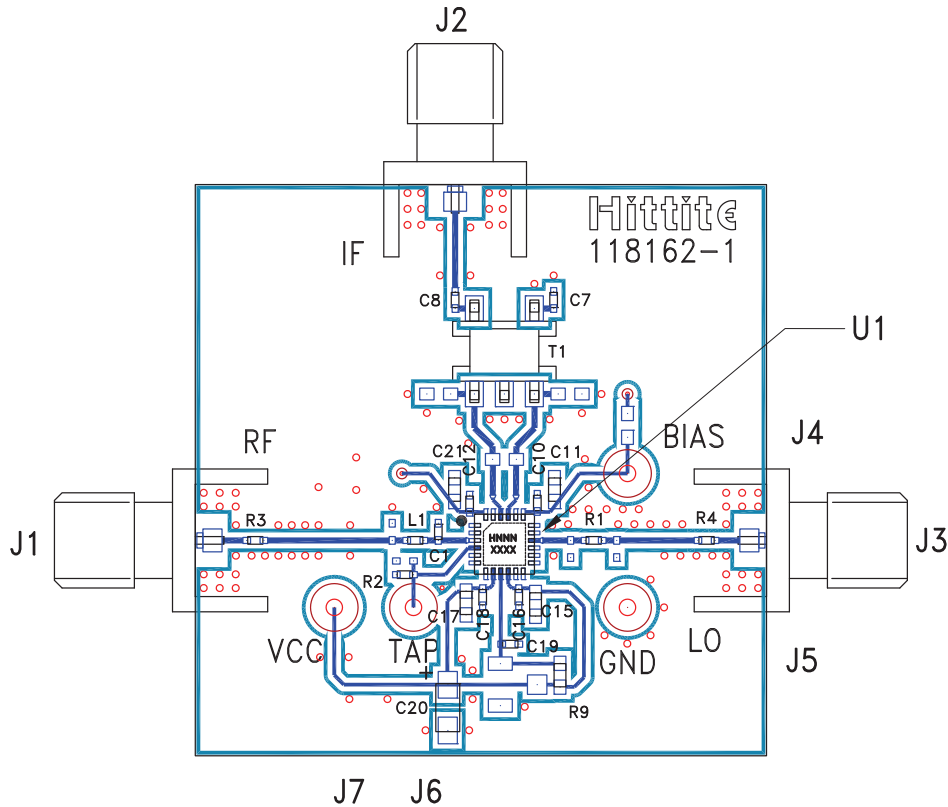

**List of Materials for Evaluation PCB 120818 [1]**

Item	Description
J1 - J3	SMA Connector
J4 - J7	DC Pin
C19	22 pF Capacitor, 0402 Pkg.
C7, C8	10 nF Capacitor, 0402 Pkg.
C10, C12, C16, C18	1 nF Capacitor, 0402 Pkg.
C11, C15, C17, C21	0.1 $\mu$ F Capacitor, 0402 Pkg.
C1	0.4 pF Capacitor, 0402 Pkg.
C20	4.7 $\mu$ F Case A, Tantalum
L1	2.2 nH Inductor, 0402 Pkg.
R1 - R4	0 Ohm Resistor, 0402 Pkg.
R9	200 Ohm Resistor, 0603 Pkg.
T1	1:1 Transformer - Tyco MABACT0039
U1	HMC666LP4(E) Double Balanced Mixer
PCB [2]	118162 Evaluation PCB

The circuit board used in the application should use RF circuit design techniques. Signal lines should have 50 Ohm impedance while the package ground leads and exposed paddle should be connected directly to the ground plane similar to that shown. A sufficient number of via holes should be used to connect the top and bottom ground planes. The evaluation circuit board shown is available from Hittite upon request.

[1] Reference this number when ordering complete evaluation PCB

[2] Circuit Board Material: Arlon 25R, FR4

**BiCMOS MMIC MIXER W/ INTEGRATED  
LO AMPLIFIER, 3.1 - 3.9 GHz**



**Application Circuit**

