

THIS DOCUMENT IS THE PROPERTY OF
KEYSTONE ELECTRONICS CORP. AND
SHALL NOT BE REPRODUCED, DISTRIBUTED
OR USED AS A BASIS FOR MANUFACTURE
WITHOUT PRIOR WRITTEN PERMISSION
FROM KEYSTONE ELECTRONICS CORP.

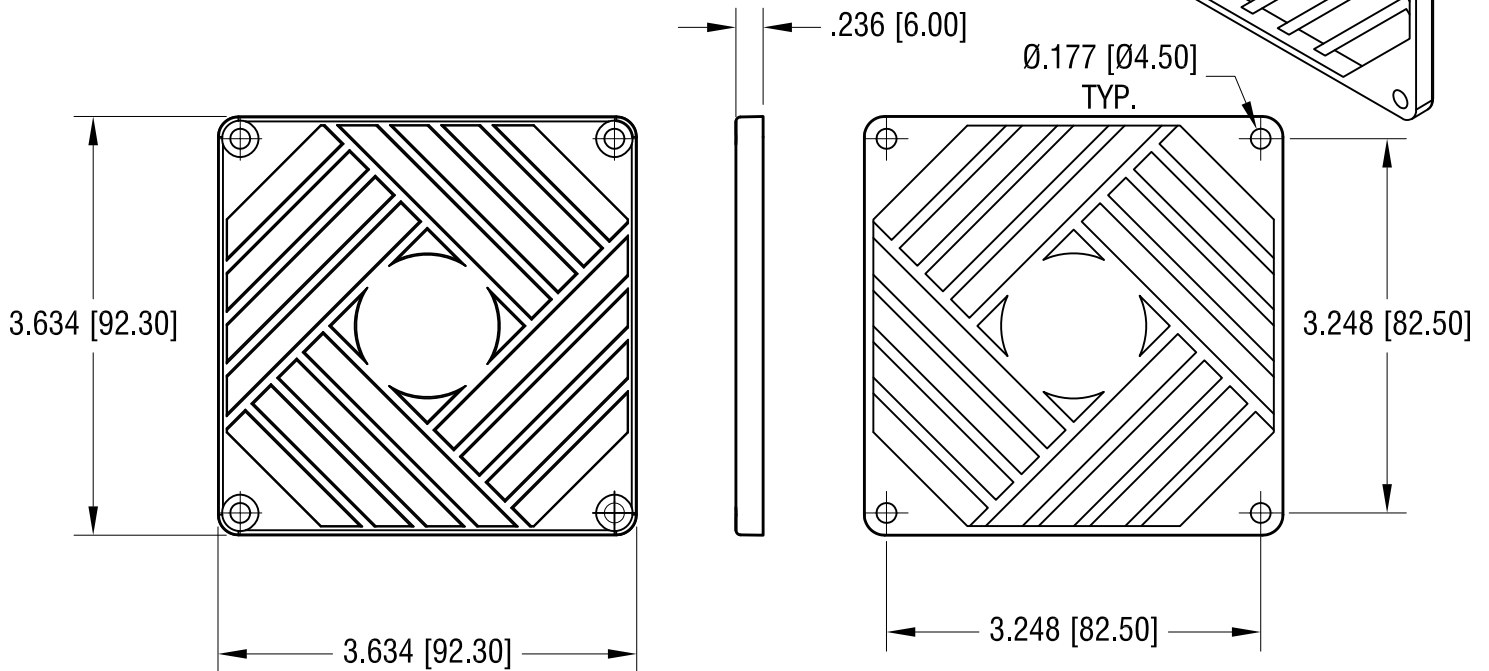

KEYSTONE ELECTRONICS CORP.

www.keyelco.com • ASTORIA, N.Y. 11105-2017 • Tel (718) 956-8900

PART NAME

FAN GUARD FOR 3.62 DIA. [92.00] DIA, FAN

MATERIAL

25% GLASS FILLED NYLON 6/6, UL-HB

FINISH

NONE

DRN BY

NT

DATE

2.04.13

APP'D

LN

SCALE

.6X

TOLERANCES

INCH [MM]

DECIMAL ± .010 [± 0.25]

ANGULAR ± 1°

UNLESS OTHERWISE SPECIFIED

CODE

C

DWG NO.

8498

DATE

DESCRIPTION

REV.