

Kunde / customer :

Artikelnummer / part number : **820 512 501**

Datum / Date : **2010-07-19**

Bezeichnung :

description : **Disk Varistor Standard WE-VD**

DIAM: **10** mm

ROHS Compliant

**A Elektrische Eigenschaften / Electrical Properties :**

TECHNICAL DATA

Part Number	Breakdown Voltage (V@mA) (*1)	Tolerance (%)	Working Voltage		Clamping Voltage V (*2)	Current Clamp. Volt. (A)	Peak Current Withstanding C. A (*3)
			AC	DC			
<b>820 512 501</b>	<b>39</b>	<b>10</b>	<b>25</b>	<b>31</b>	<b>77</b>	<b>5</b>	<b>500</b>

\* 1 The varistor voltage was measured at 0.1 mA current for 5 mm diameter and 1 mA current for other

\* 2 The Clamping voltage measured at "Current Clamping Voltage" see next column

\* 3 The Peak Current was tested at 8/20  $\mu$ s waveform for 1 time

Part Number	Rated Wattage (W)	Energy J (*4)	Capacitance pF (*5)	UL (*6)	Certification		Diameter (mm)
					CSA (*7)	VDE (*8)	
<b>820 512 501</b>	<b>0.05</b>	<b>4.7</b>	<b>3660</b>	<b>yes</b>	-	<b>yes</b>	<b>10</b>

\* 4. The Energy measured at 10/1000  $\mu$ s waveform for 1 time

\* 5. The capacitance value measured at standard frequency @ 1kHz

\* 6. Certification UL N°E332875

\* 7. Certification CSA N°224856

\* 8. Certification VDE N°40016998 & 40016986

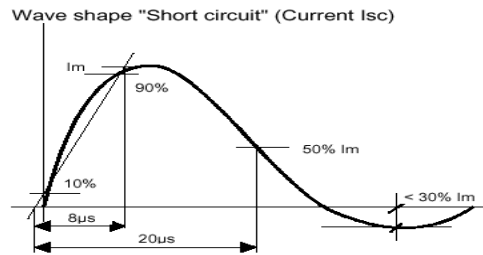

Wave during	T1	T2
8/20 $\mu$ s	8 $\mu$ s	20 $\mu$ s
10/1000 $\mu$ s	10 $\mu$ s	1000 $\mu$ s

ORDER CODE

**820**

Varistor Type

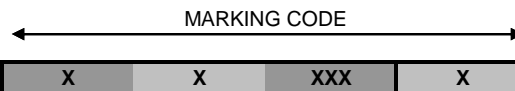

Serie

Diameter

Vrms Voltage

Tolerance

Code

Special Type

**S**

Disc Varistor

5 = Standard  
4 = High Surge

5 = 5 mm  
7 = 7 mm  
1 = 10 mm  
4 = 14 mm  
2 = 20 mm

5 = 5%  
1 = 10%  
6 = 15%  
2 = 20%  
7 = 25%  
3 = 30%

Example:  
180 = 18 V  
271 = 270 V  
102 = 1 000 V

Kunde / customer :

Artikelnummer / part number : **820 512 501**

Bezeichnung :

description : **Disk Varistor Standard WE-VD**

DIAM: **10** mm

**B Mechanische Abmessungen / Dimensions :**

SIZE

Diameter*	Ø 5	Ø 7	Ø 10	Ø 14	Ø 20
D max.	7,5	9,0	12,5	16,5	23,0
d +/-0,05	0,6	0,6	0,8	0,8	1,0
F +/-1,0	5,0	5,0	7,5	7,5	10,0
H max.	11	13	18	22	28
H1 max	3,5	3,5	5,0	5,0	5,0
L1 min.	25	25	25	25	25
L min.	24	24	24	24	24

(mm) - \*Nominal Disk Diameter of Bare Disk

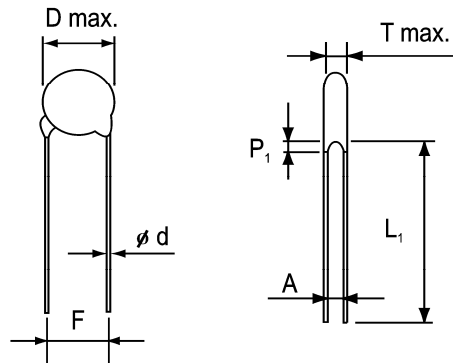

Table of T max., A & P<sub>1</sub> . Unit : (mm)

Diameter	Ø 5			Ø 7			Ø 10			Ø 14			Ø 20		
	T max A+/-0,8	P <sub>1</sub>		T max A+/-0,8	P <sub>1</sub>		T max A+/-0,8	P <sub>1</sub>		T max A+/-0,8	P <sub>1</sub>		T max A+/-0,8	P <sub>1</sub>	
110	4,5	1,4	3,0	4,5	1,4	3,0	4,9	1,4	3,0	5,0	1,5	3,0	5,2	1,5	3,0
140	4,5	1,5	3,0	4,5	1,5	3,0	4,9	1,5	3,0	5,0	1,6	3,0	5,3	1,6	3,0
170	4,7	1,5	3,0	4,7	1,5	3,0	5,1	1,5	3,0	5,2	1,7	3,0	5,4	1,7	3,0
200	4,7	1,6	3,0	4,7	1,6	3,0	5,1	1,6	3,0	5,2	1,8	3,0	5,4	1,8	3,0
250	4,7	1,8	3,0	4,7	1,8	3,0	5,1	1,8	3,0	5,2	2,0	3,0	5,4	2,0	3,0
300	5,0	1,8	3,0	5,0	1,8	3,0	5,5	1,8	3,0	5,6	2,0	3,0	5,6	2,0	3,0
350	5,0	2,0	3,0	5,0	2,0	3,0	5,5	2,0	3,0	5,6	2,2	3,0	5,6	2,2	3,0
400	5,5	2,3	3,0	5,5	2,3	3,0	6,0	2,3	3,0	6,1	2,5	3,0	6,1	2,5	3,0
500	3,8	1,4	3,0	3,8	1,4	3,0	4,3	1,4	3,0	4,4	1,6	3,0	4,9	1,8	3,0
600	3,9	1,4	3,0	3,9	1,4	3,0	4,4	1,4	3,0	4,5	1,6	3,0	5,1	1,8	3,0
750	4,1	1,5	3,0	4,1	1,5	3,0	4,5	1,5	3,0	4,6	1,7	3,0	5,3	1,9	3,0
950	4,5	1,8	3,0	4,5	1,8	3,0	4,9	1,8	3,0	5,1	2,0	3,0	5,6	2,2	3,0
111	4,1	1,6	3,0	4,1	1,6	3,0	4,5	1,6	3,0	4,7	1,8	3,0	5,2	2,0	3,0
131	4,2	1,6	3,0	4,2	1,6	3,0	4,6	1,6	3,0	4,8	1,8	3,0	5,3	2,0	3,0
141	4,3	1,7	3,0	4,3	1,7	3,0	4,7	1,7	3,0	4,9	1,9	3,0	5,4	2,1	3,0
151	4,4	1,7	3,0	4,4	1,9	3,0	4,8	1,9	3,0	5,0	2,1	3,0	5,5	2,3	3,0
171	4,6	1,9	3,0	4,6	2,0	3,0	5,0	2,0	3,0	5,2	2,1	3,0	5,7	2,5	3,0
191	4,8	1,9	3,0	4,8	2,1	3,0	5,2	2,2	3,0	5,4	2,3	3,0	5,9	2,7	3,0
211	4,9	1,9	3,0	4,9	2,1	3,0	5,3	2,2	3,0	5,5	2,3	3,0	6,0	2,7	3,0
231	5,1	2,4	3,0	5,1	2,5	3,0	5,5	2,5	3,0	5,7	2,7	3,0	6,2	2,9	3,0
251	5,3	2,6	3,5	5,3	2,6	3,5	5,7	2,8	3,5	5,9	2,8	3,5	6,4	3,0	3,5
271	6,1	2,7	3,5	6,1	2,9	3,5	6,5	3,1	3,5	6,7	3,1	3,5	7,2	3,3	3,5
301	6,4	2,8	3,5	6,4	2,9	3,5	6,8	3,2	3,5	7,0	3,3	3,5	7,5	3,5	4,0
321	6,6	3,1	4,0	6,6	3,1	4,0	7,0	3,7	4,0	7,2	3,7	4,0	7,7	3,9	4,0
351	6,9	3,4	4,0	6,9	3,4	4,0	7,3	4,0	4,0	7,5	4,0	4,0	8,0	4,2	4,0
381	7,2	3,7	4,0	7,2	3,7	4,0	7,6	4,6	4,0	7,8	4,4	4,0	8,3	4,7	4,0
421	7,5	4,0	4,0	7,5	4,0	4,0	8,0	5,0	4,0	8,2	4,7	4,0	8,7	5,0	4,0
461	7,9	4,3	4,0	7,9	4,3	4,0	8,4	5,0	4,0	8,6	4,9	4,0	9,1	5,1	4,0
481				8,1	4,5	4,0	8,6	5,2	4,0	8,8	5,2	4,0	9,3	5,4	4,0
511				8,3	4,7	4,0	8,8	5,2	4,0	9,0	5,2	4,0	9,5	5,4	4,0
551							9,4	6,0	4,0	9,6	6,0	4,0	10,1	6,3	4,0
621							9,9	6,0	4,0	10,1	6,2	4,0	10,7	6,4	4,0
681							10,5	6,3	4,0	10,7	6,7	4,0	11,2	6,9	4,0
102							12,6	9,8	6,0	12,8	10,2	6,0	13,5	10,4	6,0

Kunde / customer :  
 Artikelnummer / part number : **820 512 501**  
 Bezeichnung :  
 description : **Disk Varistor Standard WE-VD**      DIAM: **10** mm

**C Markierung / Marking Spec. :**

MARKING

Würth Elektronik

Characteristic

Certification

Date Code

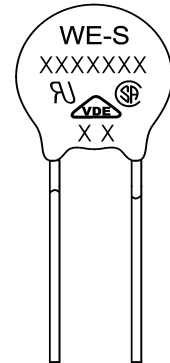

**GENERAL CHARACTERISTICS**

Max. reponse time	25 n sec
Operating temperature:	-40 to +85°C
Insulation resistance (500VDC):	Over 1000 MΩ

**LEAD FREE SOLDERING**

Solder	Tin 100%
Soldering temper ature at	255°C +/-5 °C
Profile soldering	270°C during 10s

**D Verpackung / Packaging:**

QUANTITY PER PACKING UNIT

Diameter	Ø 5		Ø 7		Ø 10		Ø 14		Ø 20			
	Bulk	Reel	Bulk	Reel	Bulk	Reel	Bulk	Reel	Bulk	Reel		
Voltage Serie	(Box)		(Box)		(Box)		(Box)		(Box)			
110 ~ 300	5 000	1 500	5 000	1 500	2 500	1 000	1 500	750	750	500		
350 ~ 400	5 000	1 500	5 000	1 500	2 500	1 000	1 500	750	750	500		
500 ~ 210	5 000	1 500	5 000	1 500	2 500	1 000	1 500	750	750	500		
230 ~ 250	5 000	1 500	5 000	1 500	2 500	1 000	1 500	750	750	500		
271 ~ 301	5 000	1 500	5 000	1 000	2 500	750	1 500	750	750	500		
321 ~ 461	4 000	1 000	4 000	1 000	1 500	500	750	500	450	500		
481 ~ 102	-	-	-	-	-	-	1 500	500	750	500	450	500

QUANTITY PER CARTON UNIT

Packaging	Bulk (Box)	Reel	Reel Ø 14 / 20
Box size	290 x 155 x 110	350 x 350 x 108	350 x 350 x 7
Carton size	310 x 328 x 250	371 x 371 x 590	370 x 370 x 468
One carton with	4 boxes	5 boxes (10 reels)	6 boxes

Kunde / customer :  
 Artikelnummer / part number : **820 512 501**  
 Bezeichnung :  
 description : **Disk Varistor Standard WE-VD** DIAM: **10** mm

**E Rollenspezifikation / Tape and Reel Specification :**

**TAPE**

**1/2" pitch**

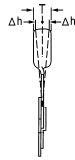
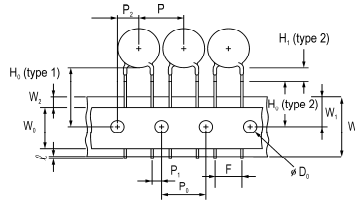

**1.0" pitch**

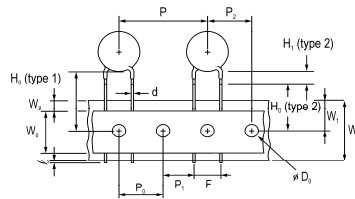

**REEL DIMENSION**

(Unit : mm)

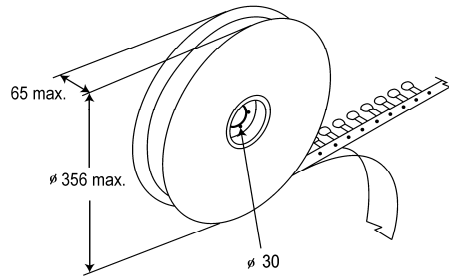

Item	Ø 5 / 7	Ø 10	Ø 10 / 14 / 20	Ø 14 / 20
<b>Taping pitch</b>	<b>1/2"</b>		<b>1.0"</b>	
I	1,1 mm maxi.		1,1 mm maxi.	
H <sub>1</sub> (type 2)	3,5 mm max.	5 mm max.	5 mm maxi.	
H <sub>0</sub> (type 2)	16 +/-0,5 mm		16 +/-0,5 mm	
H <sub>0</sub> (type 1)	16 à 21 mm		16 à 21 mm	
h	+/-2 mm		+/-2 mm	
W	18 mm +1 / - 0,5 mm		18 mm +1 / - 0,5 mm	
W <sub>0</sub>	10 mm		12 mm	
W <sub>1</sub>	9 mm +0,75 / -0,5 mm		9 mm +0,75 / -0,5 mm	
W <sub>2</sub>	3 mm maxi.		3 mm maxi.	
F	5 mm +0,8 / -0,2 mm		7,5 mm +0,8 / -0,2 mm	10 mm +0,8 / -0,2 mm
P	12,7 mm +/-1 mm		25,4 mm +/-1 mm	
P <sub>0</sub>	12,7 mm +/-0,3 mm		12,7 mm +/-0,3 mm	
P <sub>1</sub>	3,85 mm +/-0,7 mm		8,95 mm +/-0,7 mm	7,7 mm +/-0,7 mm
P <sub>2</sub>	6,35 mm +/-1,3 mm		12,7 mm +/-1,3 mm	
D <sub>0</sub>	4 mm +/-0,2 mm		4 mm +/-0,2 mm	
d	0,6 mm +/-0,05 mm		0,8 mm +/-0,05 mm	1,0 mm +/-0,05 mm
t <sub>1</sub>	0,7 mm +/-0,05 mm		0,6 mm +/-0,05 mm	
t <sub>2</sub>	1,6 mm maxi.		1,8 mm maxi.	

Freigabe erteilt / general release:	<b>Kunde / customer</b>					
	Datum / date	Unterschrift / signature			JB	Version 5
<b>Würth Elektronik</b>			JP Penlou	New P/N	2006-06-01	
			JP Penlou	Customer Layout	2006-05-11	
Geprüft / checked	2010-07-19	Kontrolliert / approved	JP. Penlou	JP Penlou	Factory codes	2005-11-16
				JP Penlou	Lead Free Marking	2004-10-19
				Name	Änderung / modification	Datum / date

**Würth Elektronik eiSos GmbH & Co.KG**

D-74638 Waldenburg · Max-Eyth-Straße 1 - 3 · Germany · Telefon (+49) (0) 7942 - 945 - 0 · Telefax (+49) (0) 7942 - 945 - 400  
 http://www.we-online.com