



SANYO Semiconductors

DATA SHEET

An ON Semiconductor Company

NPN Epitaxial Planar Silicon Transistor

15GN03MA — VHF High-frequency Amplifier Applications

Applications

- VHF, RF, MIXER, OSC, IF amplifier

Features

- High cut-off frequency : $f_T=1.5\text{GHz}$ typ
- High gain : $|S_{21e}|^2=13\text{dB}$ typ ($f=0.4\text{GHz}$)
- Ultrasmall package permitting applied sets to be small and slim

Specifications

Absolute Maximum Ratings at $T_a=25^\circ\text{C}$

Parameter	Symbol	Conditions	Ratings	Unit
Collector-to-Base Voltage	V_{CBO}		20	V
Collector-to-Emitter Voltage	V_{CEO}		10	V
Emitter-to-Base Voltage	V_{EBO}		3	V
Collector Current	I_C		70	mA
Collector Dissipation	P_C	When mounted on ceramic substrate (250mm ² x0.8mm)	400	mW
Junction Temperature	T_j		150	°C
Storage Temperature	T_{stg}		-55 to +150	°C

Package Dimensions

unit : mm (typ)

7023A-009

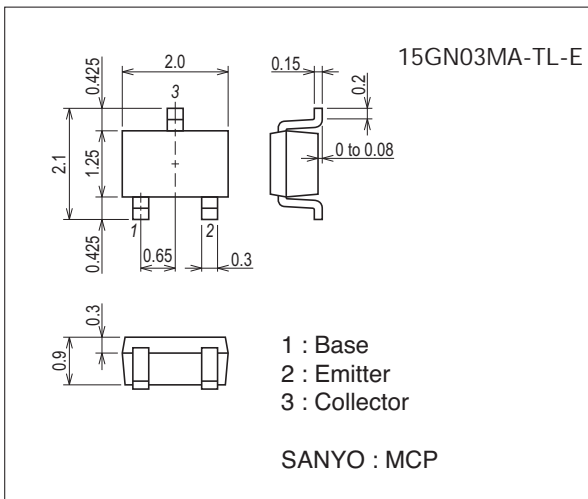

Product & Package Information

- Package : MCP
- JEITA, JEDEC : SC-70, SOT-323
- Minimum Packing Quantity : 3,000 pcs./reel

Packing Type: TL

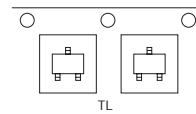

Marking

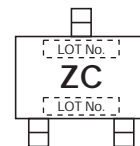

Electrical Connection

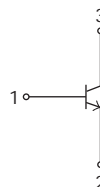

15GN03MA

Electrical Characteristics at Ta=25°C

Parameter	Symbol	Conditions	Ratings			Unit
			min	typ	max	
Collector Cutoff Current	I_{CBO}	$V_{CB}=10V, I_E=0A$			0.1	μA
Emitter Cutoff Current	I_{EBO}	$V_{EB}=2V, I_C=0A$			1	μA
DC Current Gain	h_{FE}	$V_{CE}=5V, I_C=10mA$	100		180	
Gain-Bandwidth Product	f_T	$V_{CE}=5V, I_C=20mA$	1.0	1.5		GHz
Output Capacitance	C_{ob}	$V_{CB}=10V, f=1MHz$		0.95	1.25	pF
Reverse Transfer Capacitance	C_{re}				0.65	pF
Forward Transfer Gain	$ S_{21e} ^2$	$V_{CE}=5V, I_C=20mA, f=0.4GHz$	10	13		dB
Noise Figure	NF	$V_{CE}=3V, I_C=2mA, f=0.4GHz$		1.6		dB

Ordering Information

Device	Package	Shipping	memo
15GN03MA-TL-E	MCP	3,000pcs./reel	Pb Free

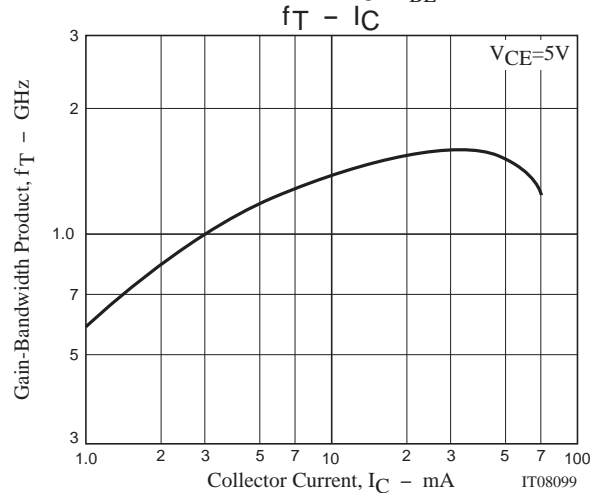
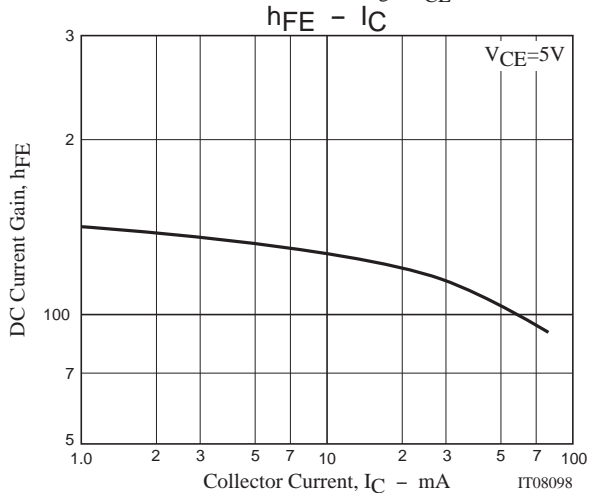
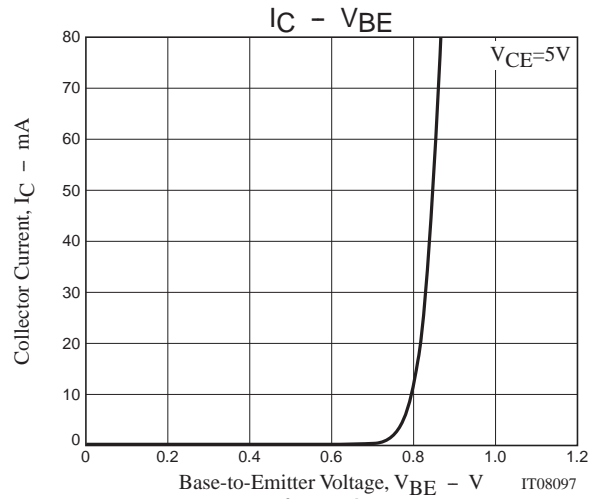
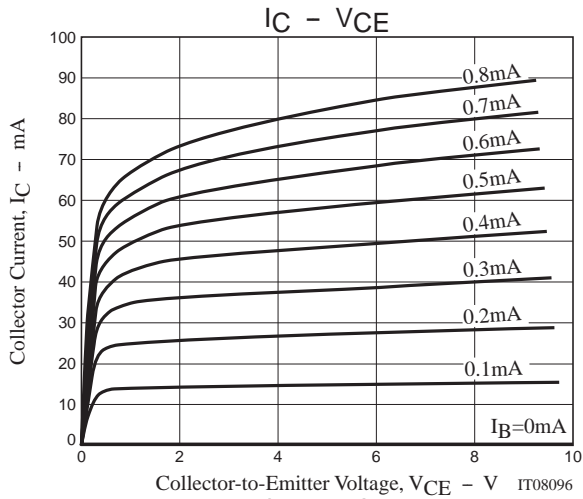

15GN03MA

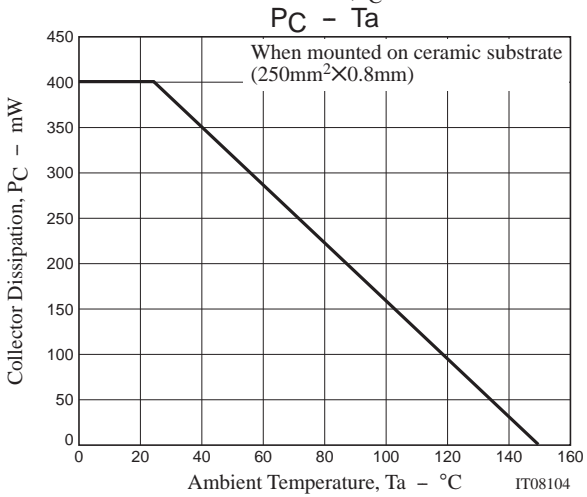
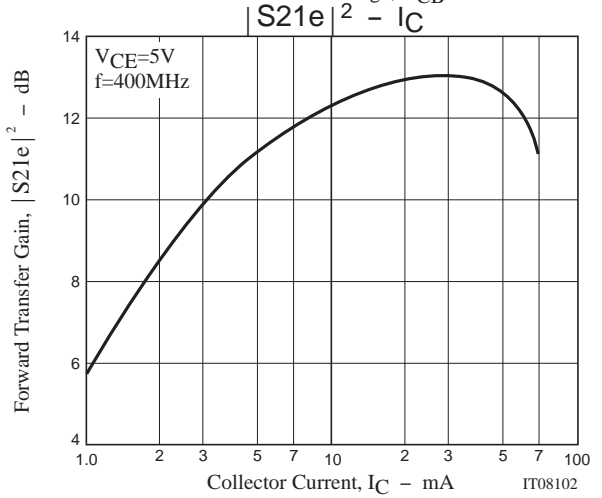
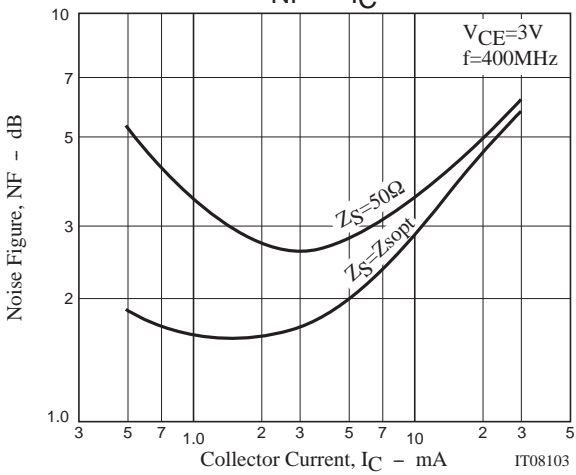
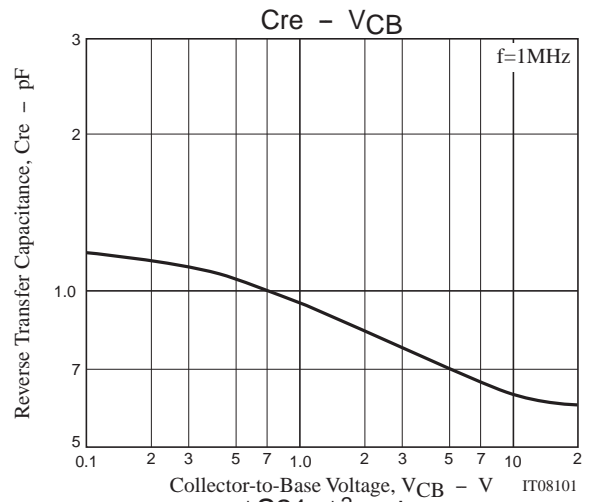
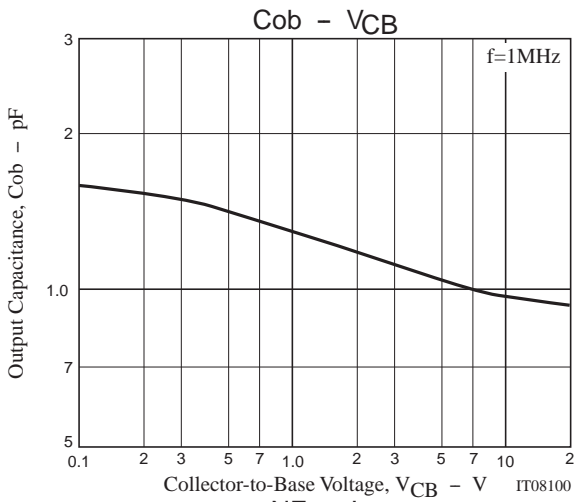

15GN03MA

S Parameters (Common emitter)

$V_{CE}=5V, I_C=1mA, Z_O=50\Omega$

Freq(MHz)	S11	$\angle S11$	S21	$\angle S21$	S12	$\angle S12$	S22	$\angle S22$
100	0.927	-39.48	3.051	153.95	0.045	66.57	0.938	-5.28
200	0.877	-72.13	2.643	134.85	0.072	53.42	0.879	-10.12
300	0.831	-97.09	2.258	118.70	0.090	41.89	0.834	-15.17
400	0.796	-115.43	1.925	105.65	0.093	33.66	0.806	-20.70
500	0.772	-128.51	1.645	95.12	0.090	29.42	0.796	-25.57
600	0.759	-139.76	1.420	86.92	0.085	28.20	0.796	-28.96
700	0.754	-148.33	1.255	80.31	0.080	30.19	0.792	-31.48
800	0.750	-155.54	1.132	74.68	0.072	36.45	0.790	-34.42
900	0.746	-162.07	1.033	69.44	0.067	44.81	0.793	-37.89
1000	0.743	-167.59	0.948	65.05	0.065	55.74	0.796	-41.83

$V_{CE}=5V, I_C=3mA, Z_O=50\Omega$

Freq(MHz)	S11	$\angle S11$	S21	$\angle S21$	S12	$\angle S12$	S22	$\angle S22$
100	0.819	-66.73	7.544	137.99	0.036	55.23	0.862	-14.15
200	0.733	-107.53	5.274	115.44	0.050	43.07	0.730	-17.07
300	0.698	-130.44	3.901	102.51	0.055	40.37	0.691	-20.60
400	0.682	-144.75	3.111	93.53	0.056	41.56	0.673	-22.18
500	0.674	-154.20	2.563	85.87	0.056	46.54	0.680	-25.14
600	0.669	-161.91	2.175	79.64	0.057	53.71	0.686	-28.23
700	0.669	-167.44	1.884	74.61	0.061	62.91	0.686	-30.58
800	0.671	-172.33	1.680	70.09	0.067	70.67	0.690	-33.35
900	0.672	-176.77	1.520	65.76	0.075	78.25	0.695	-36.65
1000	0.672	-179.40	1.386	61.98	0.086	83.86	0.700	-40.53

$V_{CE}=5V, I_C=5mA, Z_O=50\Omega$

Freq(MHz)	S11	$\angle S11$	S21	$\angle S21$	S12	$\angle S12$	S22	$\angle S22$
100	0.745	-85.56	10.487	129.32	0.031	52.32	0.808	-17.13
200	0.673	-125.68	6.596	107.46	0.041	43.79	0.695	-19.72
300	0.650	-144.45	4.641	95.99	0.044	45.46	0.655	-20.94
400	0.643	-155.93	3.583	88.14	0.046	51.02	0.641	-22.34
500	0.641	-163.08	2.926	81.98	0.051	57.47	0.638	-24.48
600	0.641	-169.17	2.468	76.86	0.055	65.57	0.640	-27.05
700	0.642	-173.85	2.139	72.14	0.064	72.10	0.640	-29.96
800	0.645	-177.59	1.898	68.01	0.072	78.01	0.643	-32.86
900	0.648	-179.02	1.708	64.03	0.082	84.74	0.654	-36.05
1000	0.649	-175.69	1.565	60.67	0.096	88.35	0.663	-39.64

$V_{CE}=5V, I_C=10mA, Z_O=50\Omega$

Freq(MHz)	S11	$\angle S11$	S21	$\angle S21$	S12	$\angle S12$	S22	$\angle S22$
100	0.648	-111.11	13.755	118.07	0.025	49.17	0.710	-18.60
200	0.617	-144.00	7.787	99.84	0.031	50.50	0.618	-18.94
300	0.610	-157.84	5.322	90.62	0.035	55.71	0.593	-19.18
400	0.611	-165.84	4.071	84.05	0.042	63.53	0.585	-20.81
500	0.612	-171.10	3.295	78.75	0.049	72.26	0.585	-23.14
600	0.616	-175.51	2.770	74.15	0.059	76.93	0.591	-25.68
700	0.620	-179.00	2.401	69.78	0.068	81.33	0.595	-28.62
800	0.622	-178.16	2.122	65.84	0.080	85.49	0.598	-31.66
900	0.629	-175.42	1.906	62.06	0.091	88.11	0.610	-34.80
1000	0.632	-172.79	1.741	58.71	0.104	90.16	0.619	-38.30

15GN03MA

S Parameters (Common emitter)

$V_{CE}=5V, I_C=15mA, Z_O=50\Omega$

Freq(MHz)	S11	$\angle S11$	S21	$\angle S21$	S12	$\angle S12$	S22	$\angle S22$
100	0.608	-124.26	15.141	112.79	0.021	49.66	0.661	-18.68
200	0.596	-152.05	8.271	96.59	0.028	56.25	0.584	-17.69
300	0.594	-163.33	5.613	88.34	0.034	63.87	0.566	-18.43
400	0.600	-169.82	4.267	82.26	0.042	71.61	0.561	-19.87
500	0.601	-173.91	3.457	77.23	0.052	77.39	0.564	-22.13
600	0.606	-177.77	2.902	72.65	0.061	81.90	0.570	-24.90
700	0.613	179.41	2.501	68.50	0.071	84.02	0.573	-27.96
800	0.617	176.72	2.210	64.59	0.083	86.75	0.579	-30.98
900	0.624	174.31	1.988	60.86	0.094	88.46	0.592	-34.26
1000	0.628	171.96	1.808	57.39	0.108	90.57	0.599	-37.51

$V_{CE}=5V, I_C=20mA, Z_O=50\Omega$

Freq(MHz)	S11	$\angle S11$	S21	$\angle S21$	S12	$\angle S12$	S22	$\angle S22$
100	0.587	-132.33	15.887	109.73	0.018	50.98	0.630	-18.23
200	0.589	-156.83	8.517	94.77	0.026	60.57	0.563	-17.10
300	0.590	-166.31	5.751	86.97	0.034	66.88	0.549	-17.73
400	0.593	-171.88	4.373	80.95	0.043	73.76	0.547	-19.30
500	0.598	-175.61	3.529	76.08	0.052	79.21	0.552	-21.55
600	0.604	-178.89	2.958	71.70	0.063	82.86	0.558	-24.41
700	0.611	178.36	2.550	67.43	0.073	85.71	0.560	-27.19
800	0.616	176.07	2.257	63.56	0.085	87.76	0.569	-30.31
900	0.624	173.75	2.026	59.99	0.097	89.02	0.581	-33.63
1000	0.628	171.39	1.838	56.47	0.109	90.88	0.590	-36.92

$V_{CE}=5V, I_C=30mA, Z_O=50\Omega$

Freq(MHz)	S11	$\angle S11$	S21	$\angle S21$	S12	$\angle S12$	S22	$\angle S22$
100	0.574	-141.90	16.518	106.28	0.017	56.75	0.594	-17.60
200	0.584	-161.69	8.702	92.68	0.024	65.21	0.541	-16.13
300	0.587	-169.42	5.851	85.19	0.033	71.56	0.531	-16.69
400	0.596	-174.12	4.433	79.42	0.042	77.01	0.532	-18.41
500	0.599	-177.29	3.570	74.54	0.053	82.34	0.536	-20.78
600	0.609	179.93	2.987	70.07	0.063	84.47	0.545	-23.60
700	0.616	177.48	2.574	65.88	0.073	86.83	0.550	-26.54
800	0.621	175.27	2.268	61.99	0.085	88.18	0.559	-29.78
900	0.631	173.12	2.033	58.20	0.096	90.72	0.571	-33.08
1000	0.638	170.96	1.845	54.81	0.111	91.80	0.582	-36.46

$V_{CE}=5V, I_C=50mA, Z_O=50\Omega$

Freq(MHz)	S11	$\angle S11$	S21	$\angle S21$	S12	$\angle S12$	S22	$\angle S22$
100	0.578	-151.54	16.222	102.78	0.015	58.15	0.564	-16.24
200	0.596	-166.79	8.428	90.13	0.023	71.59	0.524	-14.78
300	0.603	-172.63	5.641	82.89	0.033	76.27	0.520	-15.94
400	0.611	-176.28	4.254	77.21	0.043	79.95	0.521	-17.71
500	0.618	-178.98	3.421	72.11	0.052	83.78	0.530	-20.31
600	0.629	178.44	2.851	67.60	0.064	86.83	0.538	-23.39
700	0.639	176.23	2.452	63.15	0.074	88.24	0.546	-26.40
800	0.647	174.01	2.155	59.33	0.087	89.54	0.555	-29.74
900	0.657	171.87	1.921	55.44	0.099	92.59	0.568	-33.37
1000	0.664	169.65	1.740	51.95	0.113	94.10	0.581	-36.94

15GN03MA

Embossed Taping Specification

15GN03MA-TL-E

1. Packing Format

Package Name	Carrier Tape Type	Maximum Number of devices contained (pcs)			Packing format	
		Reel	Inner box	Outer box	Inner BOX (C-1)	Outer BOX (A-7)
MCP	MCP	3,000	15,000	90,000	5 reels contained Dimensions:mm (external) 183×72×185	6 inner boxes contained Dimensions:mm (external) 440×195×210

Reel label, Inner box label
(unit:mm)

Outer box label

It is a label at the time of factory shipments.
The form of a label may change in physical distribution process.

Packing method

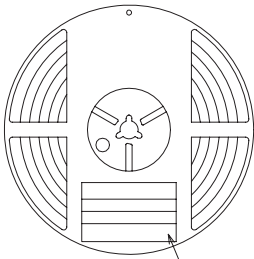

Reel label

Type No.
LOT No.
Quantity
Origin

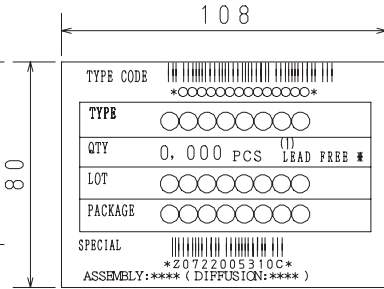
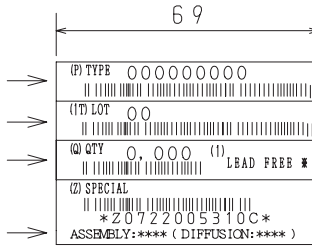

NOTE (1)

The LEAD FREE ⚡ description shows that the surface treatment of the terminal is lead free.

Label	JEITA Phase
LEAD FREE 3	JEITA Phase 3A
LEAD FREE 4	JEITA Phase 3

2. Taping configuration

2-1. Carrier tape size (unit:mm)

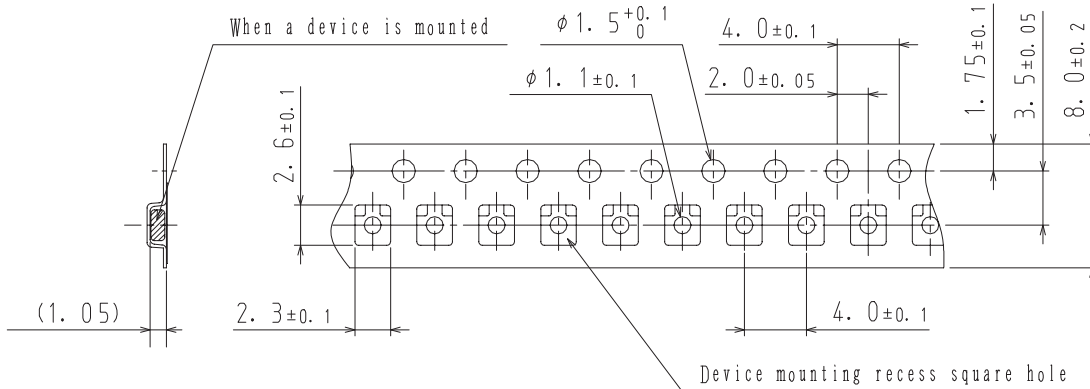

2-2. Device placement direction

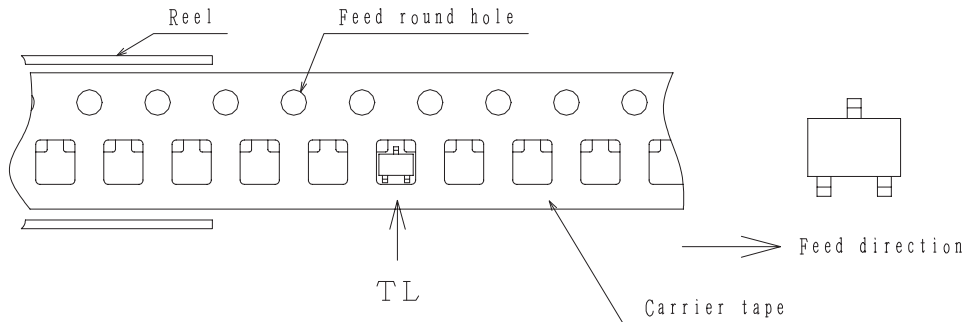

Those with oen electrode terminal on the feed hole side.....TL

15GN03MA

Outline Drawing

15GN03MA-TL-E

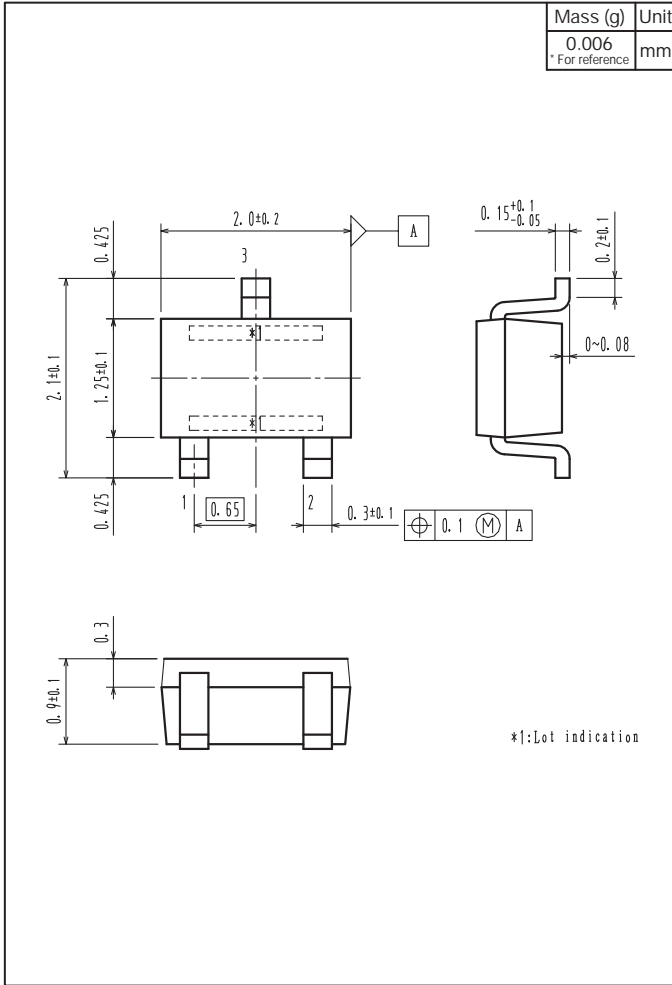

Land Pattern Example

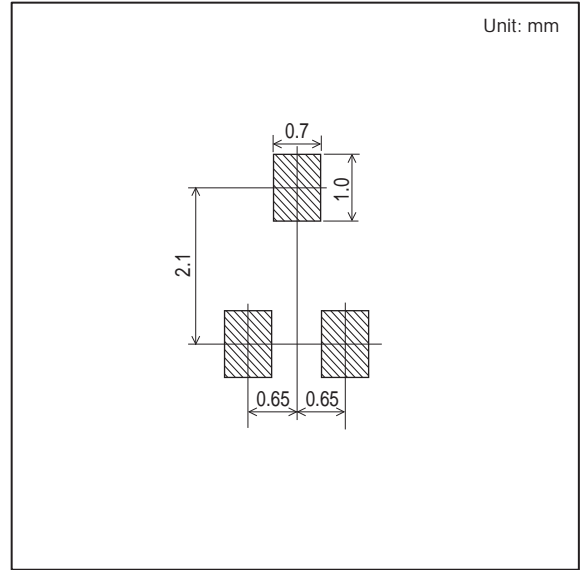

- Any and all SANYO Semiconductor Co.,Ltd. products described or contained herein are, with regard to "standard application", intended for the use as general electronics equipment. The products mentioned herein shall not be intended for use for any "special application" (medical equipment whose purpose is to sustain life, aerospace instrument, nuclear control device, burning appliances, transportation machine, traffic signal system, safety equipment etc.) that shall require extremely high level of reliability and can directly threaten human lives in case of failure or malfunction of the product or may cause harm to human bodies, nor shall they grant any guarantee thereof. If you should intend to use our products for new introduction or other application different from current conditions on the usage of automotive device, communication device, office equipment, industrial equipment etc. , please consult with us about usage condition (temperature, operation time etc.) prior to the intended use. If there is no consultation or inquiry before the intended use, our customer shall be solely responsible for the use.
- Specifications of any and all SANYO Semiconductor Co.,Ltd. products described or contained herein stipulate the performance, characteristics, and functions of the described products in the independent state, and are not guarantees of the performance, characteristics, and functions of the described products as mounted in the customer's products or equipment. To verify symptoms and states that cannot be evaluated in an independent device, the customer should always evaluate and test devices mounted in the customer's products or equipment.
- SANYO Semiconductor Co.,Ltd. assumes no responsibility for equipment failures that result from using products at values that exceed, even momentarily, rated values (such as maximum ratings, operating condition ranges, or other parameters) listed in products specifications of any and all SANYO Semiconductor Co.,Ltd. products described or contained herein.
- Regarding monolithic semiconductors, if you should intend to use this IC continuously under high temperature, high current, high voltage, or drastic temperature change, even if it is used within the range of absolute maximum ratings or operating conditions, there is a possibility of decrease reliability. Please contact us for a confirmation.
- SANYO Semiconductor Co.,Ltd. strives to supply high-quality high-reliability products, however, any and all semiconductor products fail or malfunction with some probability. It is possible that these probabilistic failures or malfunction could give rise to accidents or events that could endanger human lives, trouble that could give rise to smoke or fire, or accidents that could cause damage to other property. When designing equipment, adopt safety measures so that these kinds of accidents or events cannot occur. Such measures include but are not limited to protective circuits and error prevention circuits for safe design, redundant design, and structural design.
- In the event that any or all SANYO Semiconductor Co.,Ltd. products described or contained herein are controlled under any of applicable local export control laws and regulations, such products may require the export license from the authorities concerned in accordance with the above law.
- No part of this publication may be reproduced or transmitted in any form or by any means, electronic or mechanical, including photocopying and recording, or any information storage or retrieval system, or otherwise, without the prior written consent of SANYO Semiconductor Co.,Ltd.
- Any and all information described or contained herein are subject to change without notice due to product/technology improvement, etc. When designing equipment, refer to the "Delivery Specification" for the SANYO Semiconductor Co.,Ltd. product that you intend to use.
- Upon using the technical information or products described herein, neither warranty nor license shall be granted with regard to intellectual property rights or any other rights of SANYO Semiconductor Co.,Ltd. or any third party. SANYO Semiconductor Co.,Ltd. shall not be liable for any claim or suits with regard to a third party's intellectual property rights which has resulted from the use of the technical information and products mentioned above.

This catalog provides information as of July, 2012. Specifications and information herein are subject to change without notice.