

CDMA DUAL BAND LNA GaAs MMIC

GENERAL DESCRIPTION

The NJG1135MD7 is a GaAs LNA MMIC designed for CDMA2000 dual band (Cellular and PCS) application. The NJG1135MD7 has LNA pass-through function to select high gain mode or low gain. The NJG1135MD7 achieved high IIP3 and low noise figure at the high gain mode, and low current consumption at the low gain mode. An ultra-small and ultra-thin EQFN14-D7 package is adopted.

PACKAGE OUTLINE

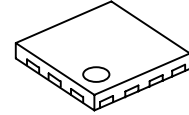

NJG1135MD7

FEATURES

- Low voltage operation +2.8V typ.
- Low control voltage operation +1.8V min.

- [LNA high gain mode]
- High input IP3 +10dBm typ. @ f=880MHz
+8dBm typ. @ f=1960MHz
- High gain +16dB typ. @ f=880MHz / 1960MHz
- Low noise figure 1.4dB typ. @ f=880MHz / 1960MHz

- [LNA low gain mode]
- Low current consumption 30uA typ.
- High input IP3 +19dBm typ. @ f=880MHz
+17dBm typ. @ f=1960MHz

- Ultra-small and ultra-thin package EQFN14-D7 (Package size: 1.6x1.6x0.397mm typ., Lead and Halogen-Free)

PIN CONFIGURATION

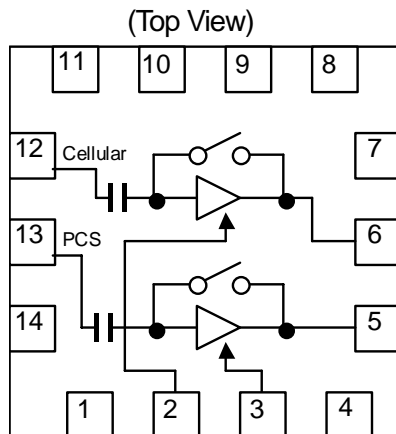

- Pin Connection
- 1. GND
 - 2. VCTL2
 - 3. VCTL1
 - 4. GND
 - 5. RFOUT1
 - 6. RFOUT2
 - 7. GND
 - 8. GND
 - 9. GND
 - 10. GND
 - 11. GND
 - 12. RFIN2
 - 13. RFIN1
 - 14. GND

TRUETH TABLE

"H"= $V_{CTL(H)}$, "L"= $V_{CTL(L)}$

VCTL1	VCTL2	Cellular band		PCS band	
		LNA	Bypass	LNA	Bypass
L	L	OFF	ON	OFF	ON
L	H	ON	OFF	OFF	ON
H	L	OFF	ON	ON	OFF
H	H	ON	OFF	ON	OFF

Note: Specifications and description listed in this datasheet are subject to change without notice.

NJG1135MD7

■ ABSOLUTE MAXIMUM RATINGS

($T_a=+25^{\circ}\text{C}$, $Z_s=Z_l=50\Omega$)

PARAMETERS	SYMBOL	CONDITIONS	RATINGS	UNITS
Supply voltage	V_{DD}		5.0	V
Control voltage	V_{CTL}	VCTL1, VCTL2 terminal	5.0	V
Input power	P_{in}	$V_{DD}=2.8\text{V}$	+15	dBm
Power dissipation	P_D	4-layer FR4 PCB with through-hole (74.2x74.2mm), $T_j=150^{\circ}\text{C}$	1300	mW
Operating temperature	T_{opr}		-40~+85	$^{\circ}\text{C}$
Storage temperature	T_{stg}		-55~+150	$^{\circ}\text{C}$

■ ELECTRICAL CHARACTERISTICS 1 (DC CHARACTERISTICS)

(General Conditions: $V_{DD}=2.8\text{V}$, $T_a=+25^{\circ}\text{C}$, $Z_s=Z_l=50\Omega$)

PARAMETERS	SYMBOL	CONDITIONS	MIN	TYP	MAX	UNITS
Operating voltage	V_{DD}		2.65	2.8	2.95	V
Control voltage (High)	$V_{CTL(H)}$		1.8	2.8	2.95	V
Control voltage (Low)	$V_{CTL(L)}$		-0.3	0	0.3	V
Operating current1 (Cellular Band High Gain mode)	I_{DD1}	RF OFF, $V_{CTL1}=0\text{V}$, $V_{CTL2}=2.8\text{V}$	-	10	14	mA
Operating current2 (PCS Band High Gain mode)	I_{DD2}	RF OFF, $V_{CTL1}=2.8\text{V}$, $V_{CTL2}=0\text{V}$	-	10	14	mA
Operating current3 (LNA all off mode)	I_{DD3}	RF OFF, $V_{CTL1}=0\text{V}$, $V_{CTL2}=0\text{V}$	-	30	60	μA
Control current1	I_{CTL1}	RF OFF, $V_{CTL1}=2.8\text{V}$	-	17	30	μA
Control current2	I_{CTL2}	RF OFF, $V_{CTL2}=2.8\text{V}$	-	17	30	μA

■ ELECTRICAL CHARACTERISTICS 2 (Cellular Band: LNA High Gain Mode)

(General Conditions: $V_{DD}=2.8V$, $V_{CTL1}=0V$, $V_{CTL2}=2.8V$, $f_{RF}=880MHz$, $T_a=+25^{\circ}C$, $Z_s=Z_l=50\Omega$, with application circuit)

PARAMETERS	SYMBOL	CONDITIONS	MIN	TYP	MAX	UNITS
Small signal gain 1	Gain1	Exclude PCB, Connector Losses (input and output) 0.11dB	14.5	16.0	-	dB
Noise figure 1	NF1	Exclude PCB, Connector Losses (input) 0.06dB	-	1.4	1.8	dB
1dB gain compression input power 1	P-1dB_1		-8	-4	-	dBm
3rd order input intercept point 1	IIP3_1	$f1=f_{RF}$, $f2=f_{RF}+100kHz$, $P_{in}=-25dBm$	+7	+10	-	dBm
RF IN VSWR 1	VSWR _i _1		-	1.5	2.0	
RF OUT VSWR 1	VSWR _o _1		-	1.5	2.0	

■ ELECTRICAL CHARACTERISTICS 3 (Cellular Band: LNA Low Gain Mode)

(General Conditions: $V_{DD}=2.8V$, $V_{CTL1}=0V$, $V_{CTL2}=0V$, $f_{RF}=880MHz$, $T_a=+25^{\circ}C$, $Z_s=Z_l=50\Omega$, with application circuit)

PARAMETERS	SYMBOL	CONDITIONS	MIN	TYP	MAX	UNITS
Small signal gain 2	Gain2	Exclude PCB, Connector Losses (input and output) 0.11dB	-4.0	-2.5	-	dB
Noise figure 2	NF2	Exclude PCB, Connector Losses (input and output) 0.11dB	-	2.5	5.0	dB
1dB gain compression input power 2	P-1dB_2		+3.5	+10.5	-	dBm
3rd order input intercept point 2	IIP3_2	$f1=f_{RF}$, $f2=f_{RF}+100kHz$, $P_{in}=-12dBm$	+15	+19	-	dBm
RF IN VSWR 2	VSWR _i _2		-	2.0	2.5	
RF OUT VSWR 2	VSWR _o _2		-	1.5	2.0	

NJG1135MD7

■ ELECTRICAL CHARACTERISTICS 4 (PCS Band: LNA High Gain Mode)

(General Conditions: $V_{DD}=2.8V$, $V_{CTL1}=2.8V$, $V_{CTL2}=0V$, $f_{RF}=1960MHz$, $T_a=+25^{\circ}C$, $Z_s=Z_l=50\Omega$, with application circuit)

PARAMETERS	SYMBOL	CONDITIONS	MIN	TYP	MAX	UNITS
Small signal gain 3	Gain3	Exclude PCB, Connector Losses (input and output) 0.22dB	14.5	16.0	-	dB
Noise figure 3	NF3	Exclude PCB, Connector Losses (input) 0.12dB	-	1.4	1.8	dB
1dB gain compression input power 3	P-1dB_3		-10	-6	-	dBm
3rd order input intercept point 3	IIP3_3	$f1=f_{RF}$, $f2=f_{RF}+100kHz$, $P_{in}=-25dBm$	+5	+8	-	dBm
RF IN VSWR 3	VSWR _i _3		-	2.3	3.1	
RF OUT VSWR 3	VSWR _o _3		-	1.5	2.2	

■ ELECTRICAL CHARACTERISTICS 5 (PCS Band: LNA Low Gain Mode)

(General Conditions: $V_{DD}=2.8V$, $V_{CTL1}=0V$, $V_{CTL2}=0V$, $f_{RF}=1960MHz$, $T_a=+25^{\circ}C$, $Z_s=Z_l=50\Omega$, with application circuit)

PARAMETERS	SYMBOL	CONDITIONS	MIN	TYP	MAX	UNITS
Small signal gain 4	Gain4	Exclude PCB, Connector Losses (input and output) 0.22dB	-5.0	-3.5	-	dB
Noise figure 4	NF4	Exclude PCB, Connector Losses (input and output) 0.22dB	-	4.0	5.5	dB
1dB gain compression input power 4	P-1dB_4		+1.5	+8.5	-	dBm
3rd order input intercept point 4	IIP3_4	$f1=f_{RF}$, $f2=f_{RF}+100kHz$, $P_{in}=-12dBm$	+13	+17	-	dBm
RF IN VSWR 4	VSWR _i _4		-	2.3	2.9	
RF OUT VSWR 4	VSWR _o _4		-	1.5	2.0	

■ TERMINAL INFORMATION

No.	SYMBOL	DESCRIPTION
1	GND	Ground terminal.
2	VCTL2	Control port 2. This terminal is set to more than +1.8V~+2.95V of logical high level for high gain mode of cellular band LNA, and set to -0.3V~+0.3V of logical low level for low gain mode of cellular band LNA.
3	VCTL1	Control port 1. This terminal is set to more than +1.8V~+2.95V of logical high level for high gain mode of PCS band LNA, and set to -0.3V~+0.3V of logical low level for low gain mode of PCS band LNA.
4	GND	Ground terminal.
5	RFOUT1	RF output terminal of PCS band signal. RF signal and DC power is input through external matching circuit connected to this terminal. External matching circuit and DC blocking capacitor are required.
6	RFOUT2	RF output terminal of cellular band signal. RF signal and DC power is input through external matching circuit connected to this terminal. External matching circuit and DC blocking capacitor are required.
7	GND	Ground terminal. This terminal is not connected with internal circuit.
8	GND	Ground terminal.
9	GND	Ground terminal. This terminal is not connected with internal circuit.
10	GND	Ground terminal. This terminal is not connected with internal circuit.
11	GND	Ground terminal.
12	RFIN2	RF input terminal of cellular band signal. RF signal is input through external matching circuit connected to this terminal. A DC blocking capacitor is not required.
13	RFIN1	RF input terminal of PCS band signal. RF signal is input through external matching circuit connected to this terminal. A DC blocking capacitor is not required.
14	GND	Ground terminal. This terminal is not connected with internal circuit.

Notes:

- 1) Ground terminal (No.1, 4, 8, and 11) should be connected with the ground plane as close as possible for good RF performance, because distance to GND makes parasitic inductance.

NJG1135MD7

■ ELECTRICAL CHARACTERISTICS (Cellular Band: LNA High Gain Mode)

(General Conditions: $V_{DD}=2.8V$, $V_{CTL1}=0V$, $V_{CTL2}=2.8V$, $f_{RF}=880MHz$, $T_a=+25^{\circ}C$, $Z_s=Z_l=50\Omega$, with application circuit)

Pout vs. Pin

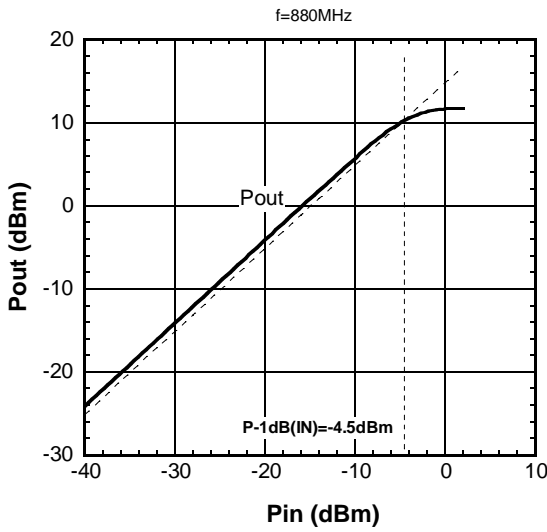

Gain, IDD vs. Pin

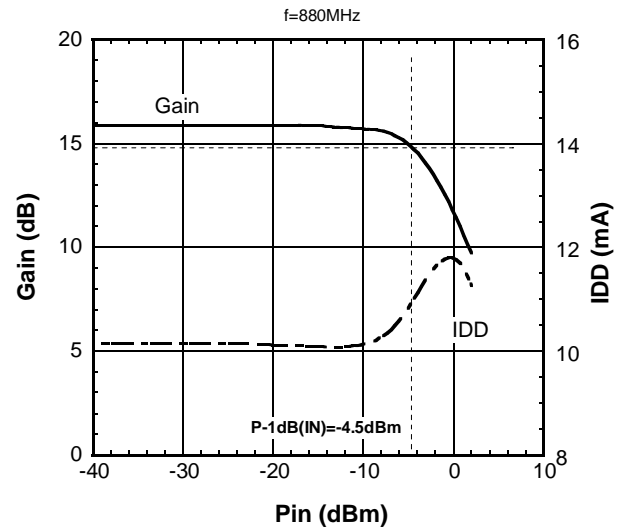

Pout, IM3 vs. Pin

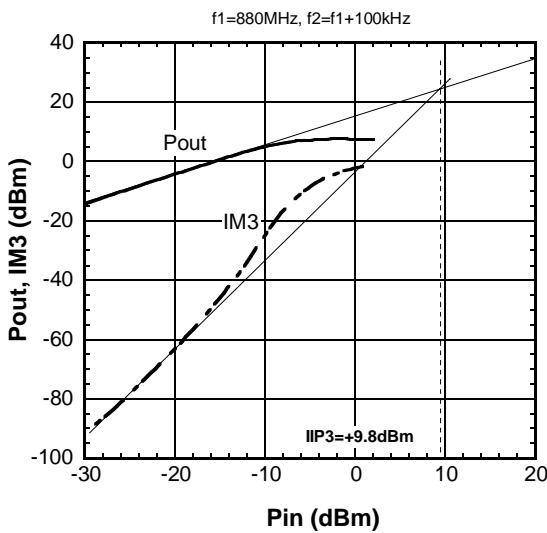

OIP3, IIP3 vs. frequency

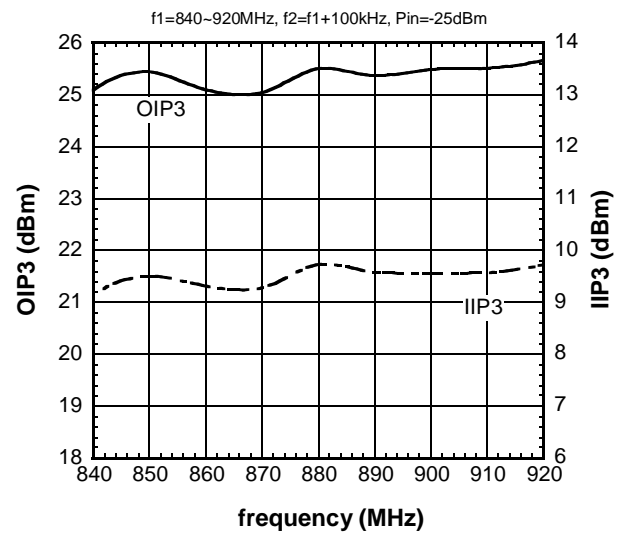

Gain, NF vs. frequency

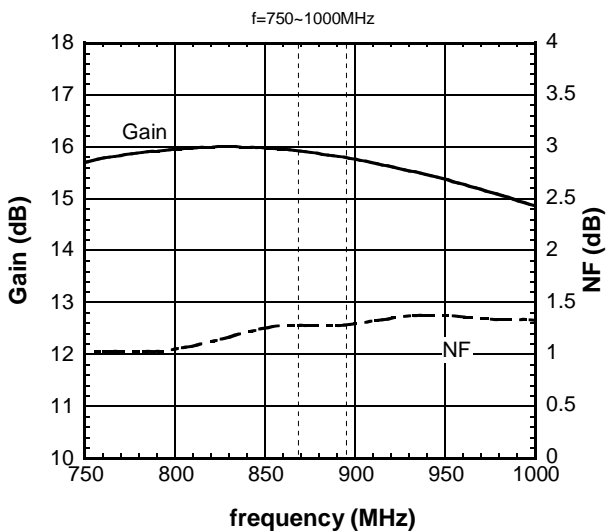

ELECTRICAL CHARACTERISTICS (Cellular Band: LNA High Gain Mode)

(General Conditions: $V_{DD}=2.8V$, $V_{CTL1}=0V$, $V_{CTL2}=2.8V$, $f_{RF}=880MHz$, $T_a=+25^\circ C$, $Z_s=Z_l=50\Omega$, with application circuit)

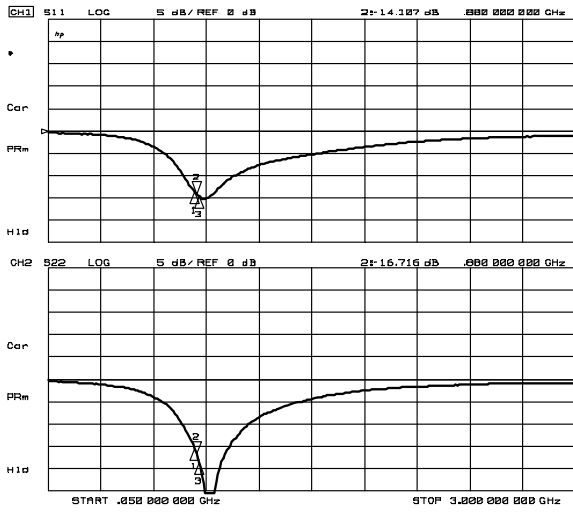

S11, S22

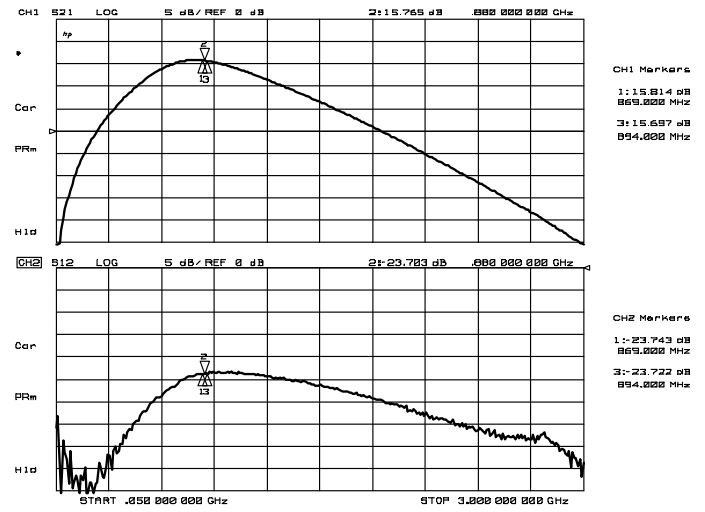

S21, S12

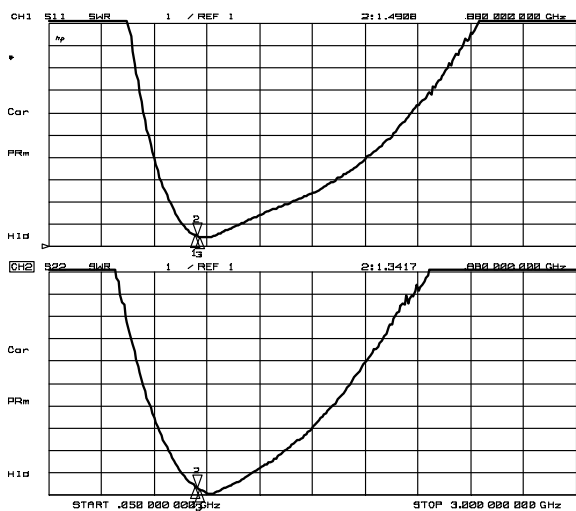

VSWR

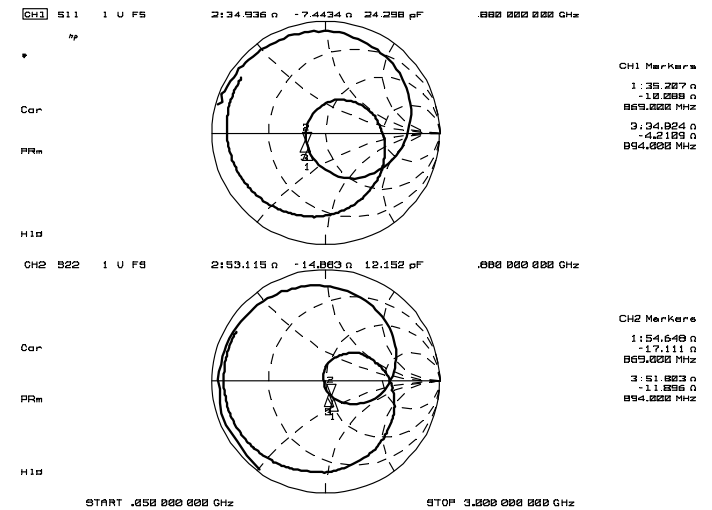

Zin, Zout

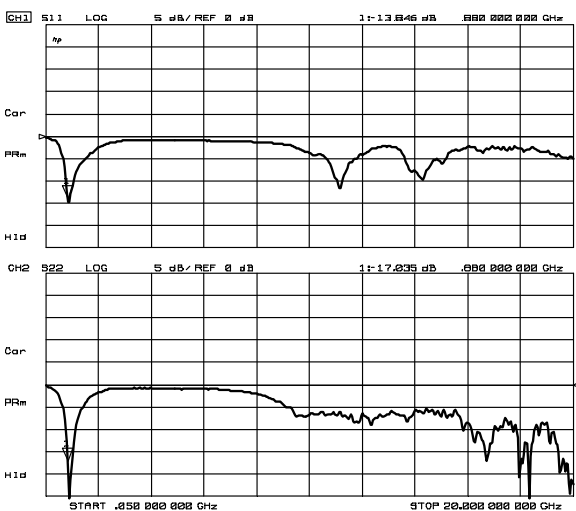

S11, S22 (~20GHz)

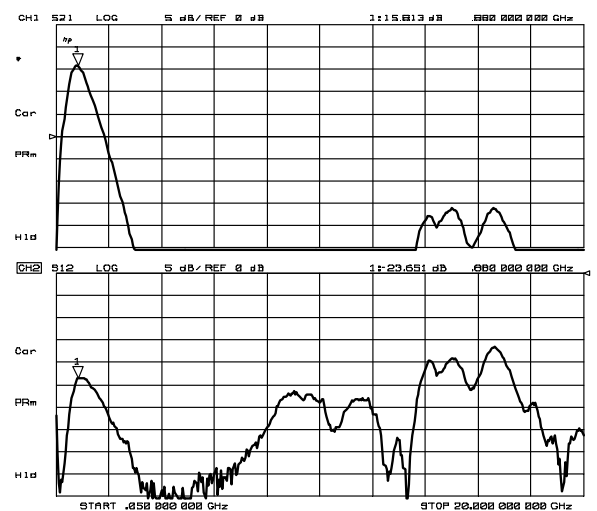

S21, S12 (~20GHz)

NJG1135MD7

ELECTRICAL CHARACTERISTICS (Cellular Band: LNA High Gain Mode)

(General Conditions: $V_{DD}=2.8V$, $V_{CTL1}=0V$, $V_{CTL2}=2.8V$, $f_{RF}=880MHz$, $Z_S=Z_L=50\Omega$, with application circuit)

Gain, NF vs. Temperature

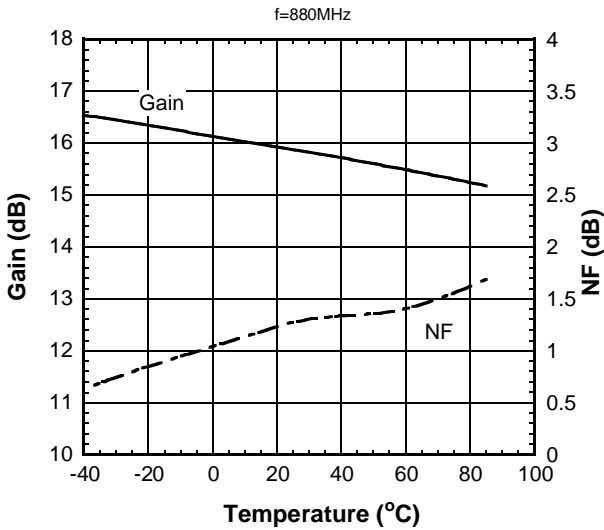

P-1dB(IN) vs. Temperature

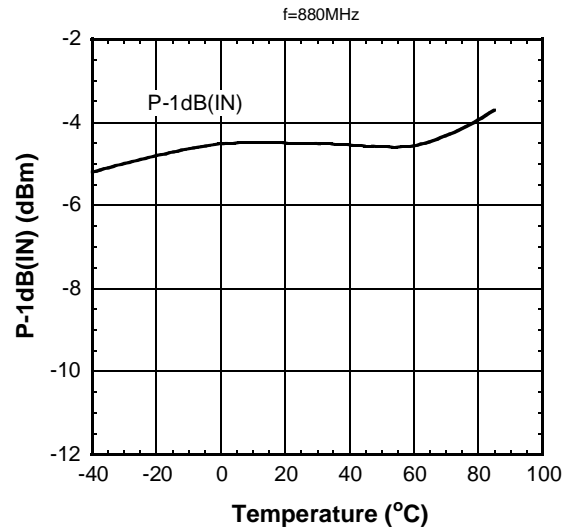

OIP3, IIP3 vs. Temperature

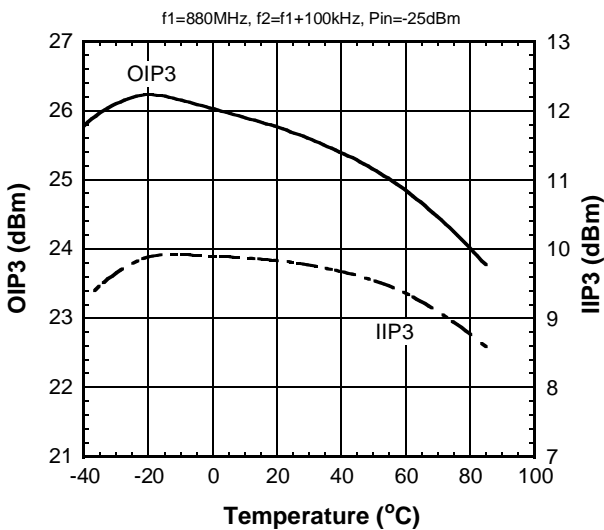

VSWRi, VSWRo vs. Temperature

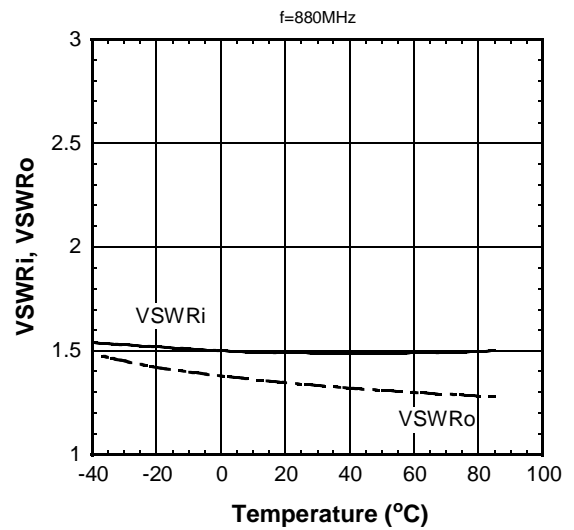

IDD, ICTL2 vs. Temperature

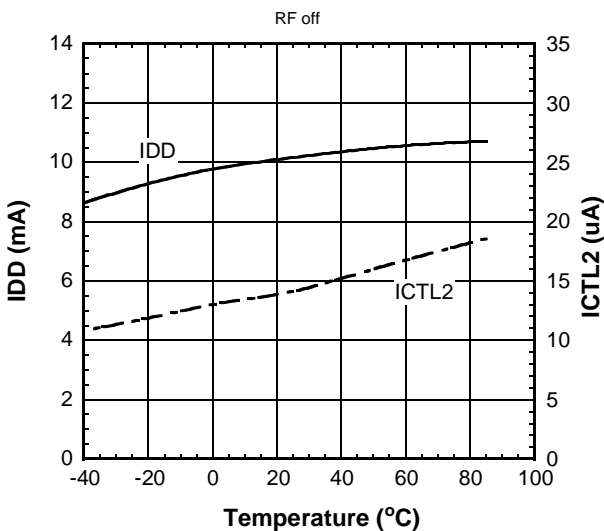

K factor vs. frequency

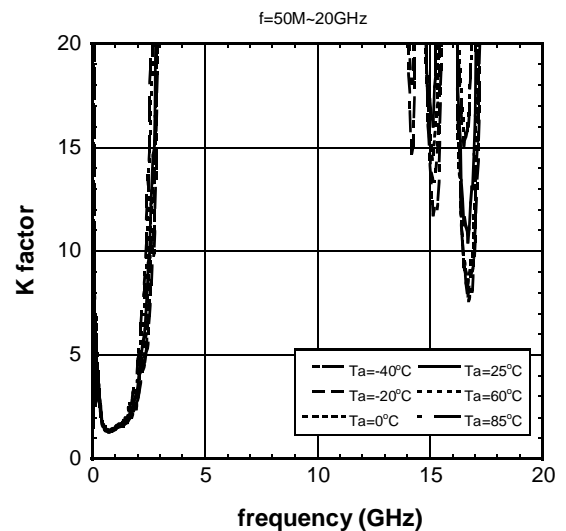

■ ELECTRICAL CHARACTERISTICS (Cellular Band: LNA Low Gain Mode)

(General Conditions: $V_{DD}=2.8V$, $V_{CTL1}=0V$, $V_{CTL2}=2.8V$, $f_{RF}=880MHz$, $T_a=+25^\circ C$, $Z_s=Z_l=50\Omega$, with application circuit)

Pout vs. Pin

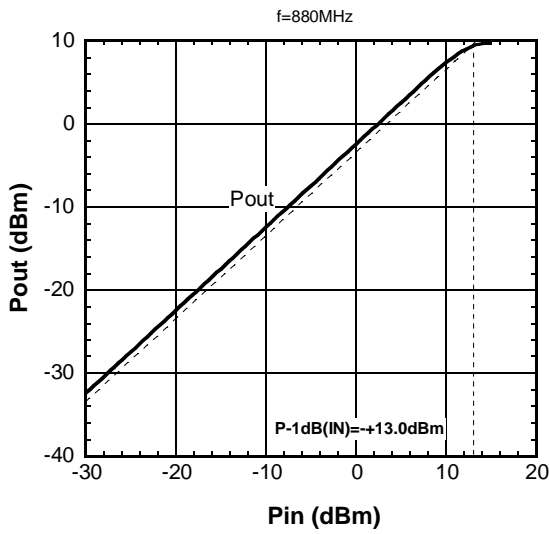

Gain, IDD vs. Pin

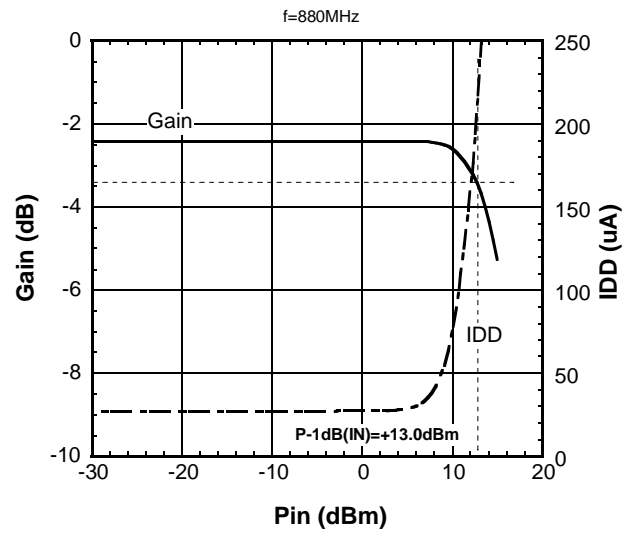

Pout, IM3 vs. Pin

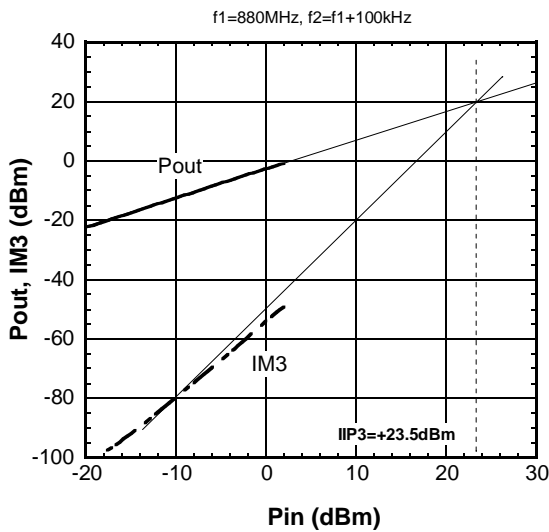

OIP3, IIP3 vs. frequency

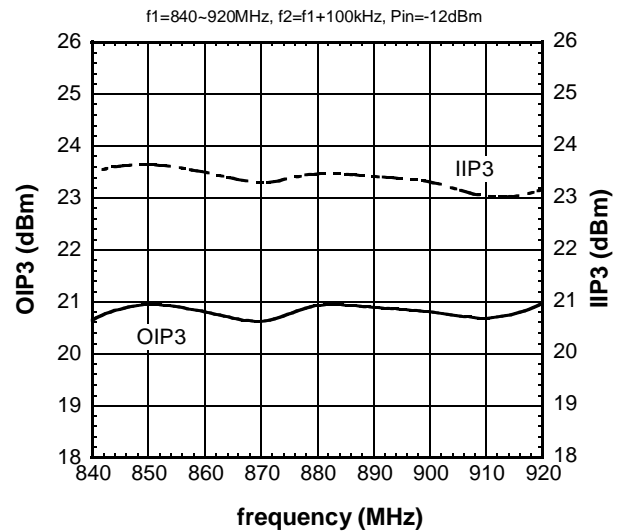

Gain, NF vs. frequency

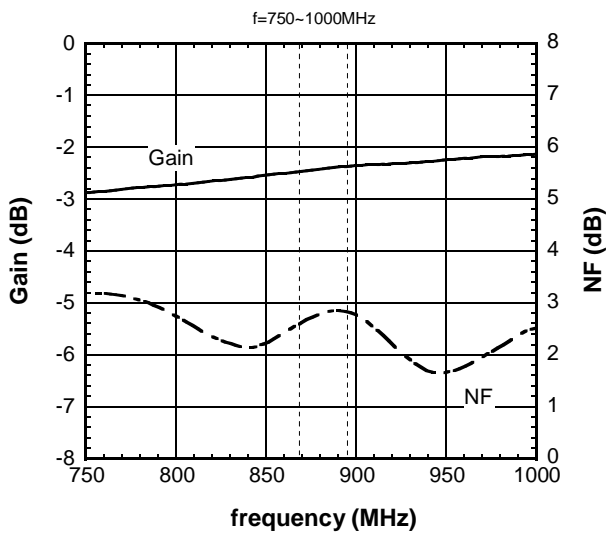

NJG1135MD7

■ ELECTRICAL CHARACTERISTICS (Cellular Band: LNA Low Gain Mode)

(General Conditions: $V_{DD}=2.8V$, $V_{CTL1}=0V$, $V_{CTL2}=2.8V$, $f_{RF}=880MHz$, $T_a=+25^\circ C$, $Z_s=Z_l=50\Omega$, with application circuit)

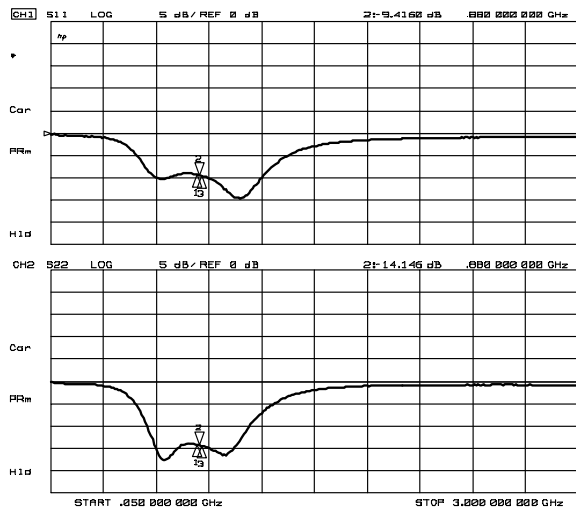

S11, S22

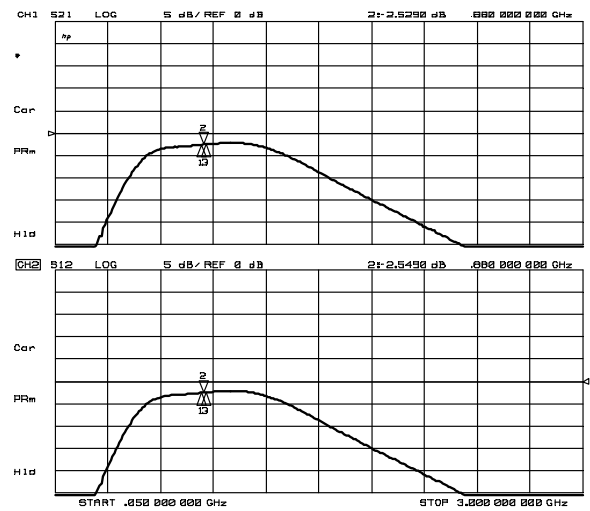

S21, S12

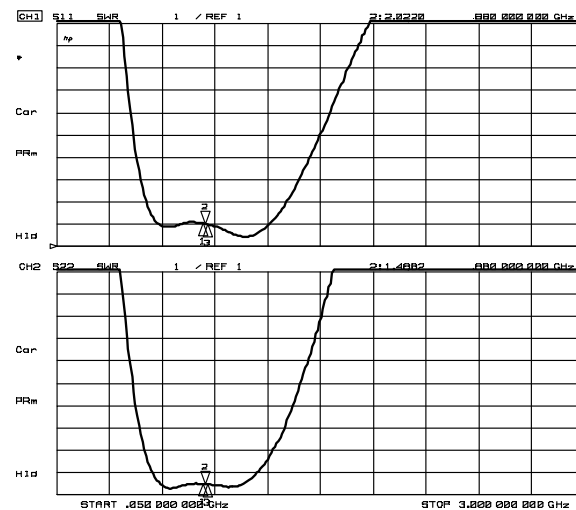

VSWR

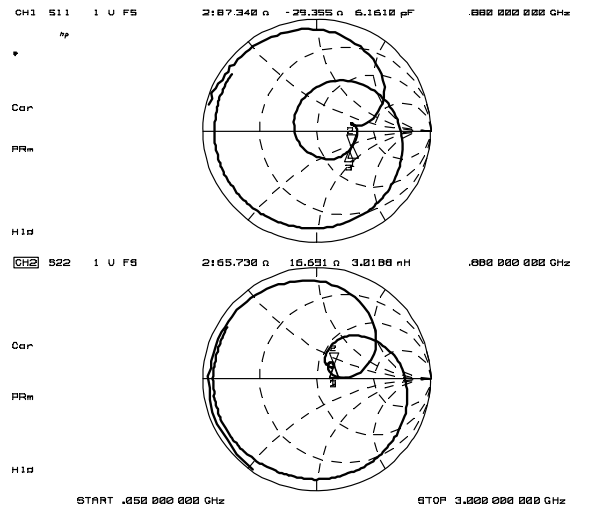

Zin, Zout

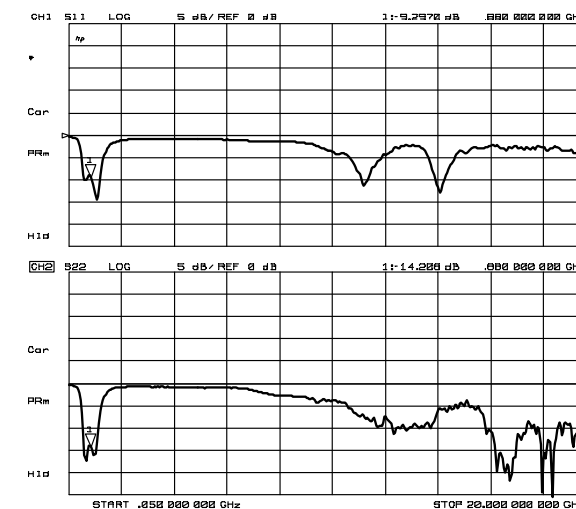

S11, S22 (~20GHz)

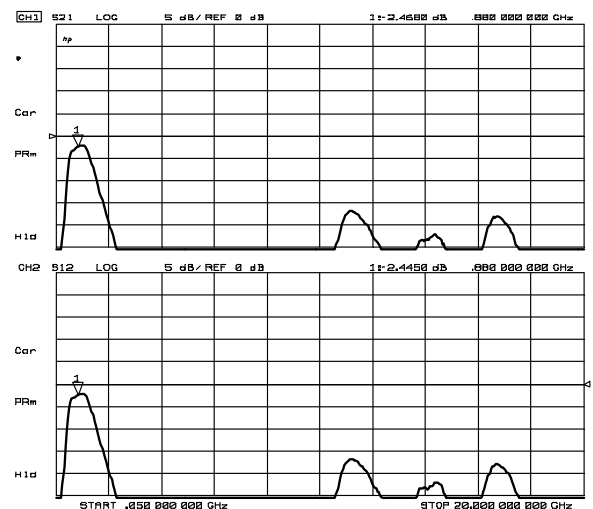

S21, S12 (~20GHz)

■ ELECTRICAL CHARACTERISTICS (Cellular Band: LNA Low Gain Mode)

(General Conditions: $V_{DD}=2.8V$, $V_{CTL1}=0V$, $V_{CTL2}=2.8V$, $f_{RF}=880MHz$, $Z_s=Z_l=50\Omega$, with application circuit)

Gain, NF vs. Temperature

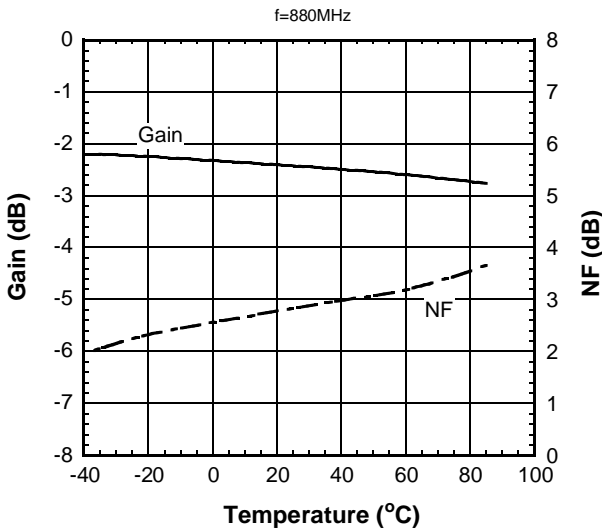

P-1dB(IN) vs. Temperature

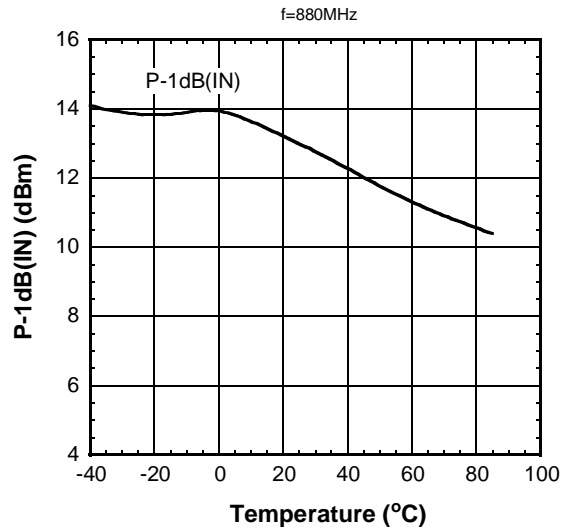

OIP3, IIP3 vs. Temperature

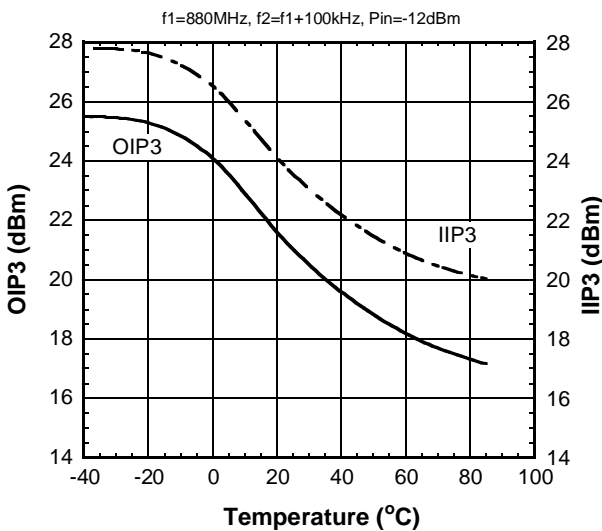

VSWRi, VSWRo vs. Temperature

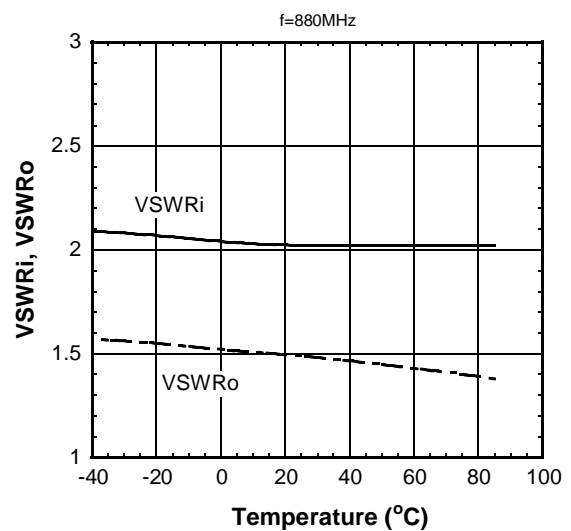

IDD vs. Temperature

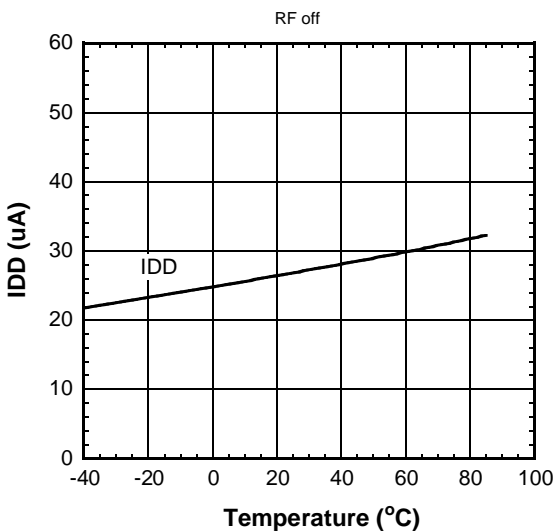

K factor vs. frequency

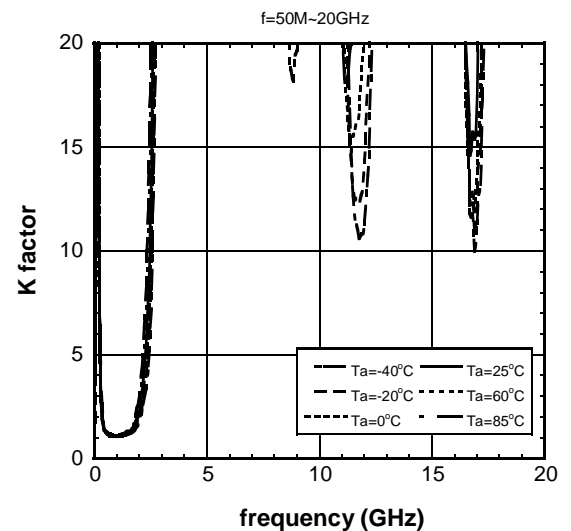

NJG1135MD7

■ ELECTRICAL CHARACTERISTICS (PCS Band: LNA High Gain Mode)

(General Conditions: $V_{DD}=2.8V$, $V_{CTL1}=0V$, $V_{CTL2}=2.8V$, $f_{RF}=1960MHz$, $T_a=+25^\circ C$, $Z_s=Z_L=50\Omega$, with application circuit)

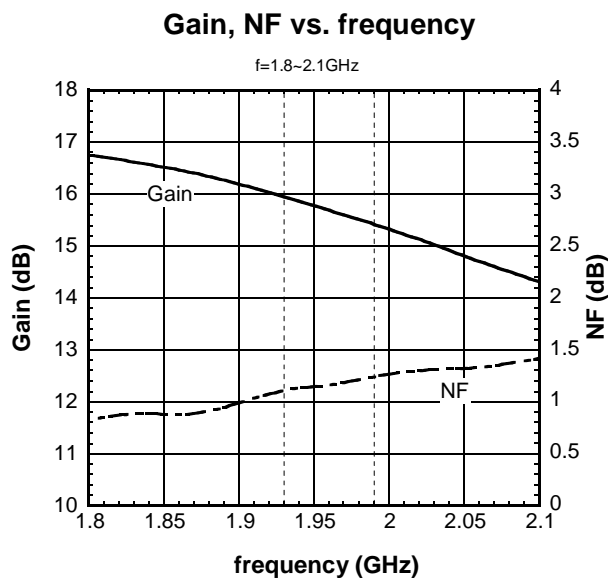
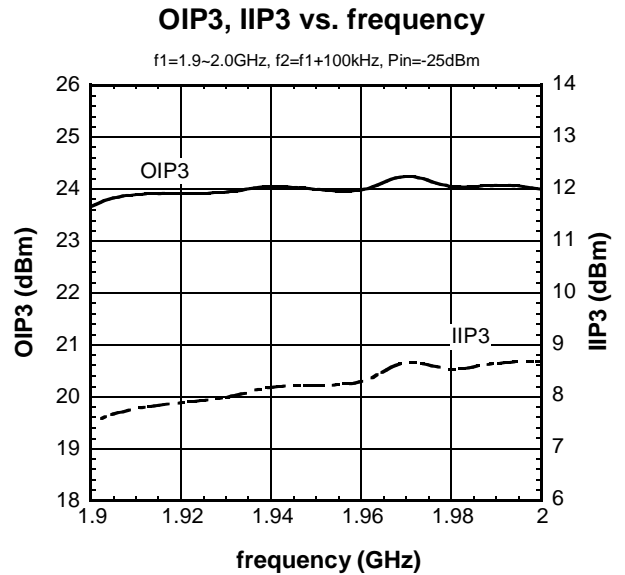
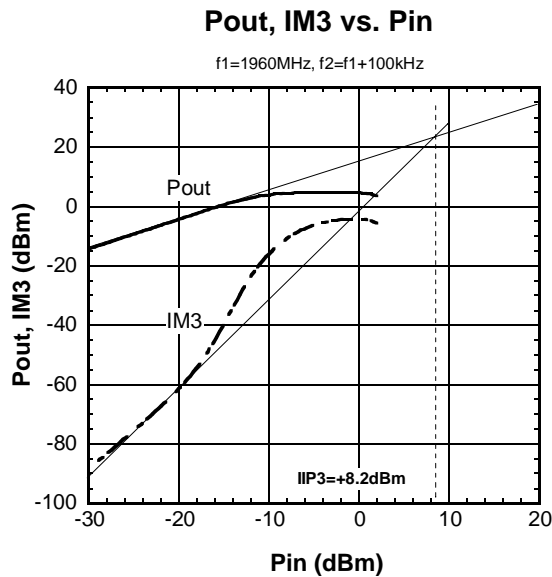
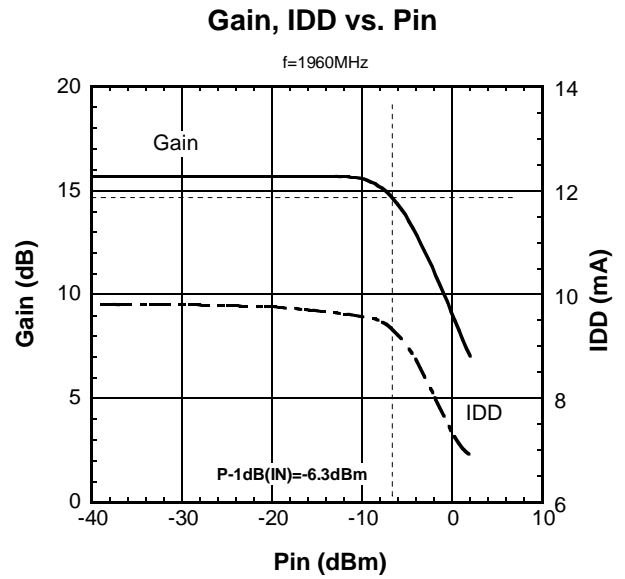
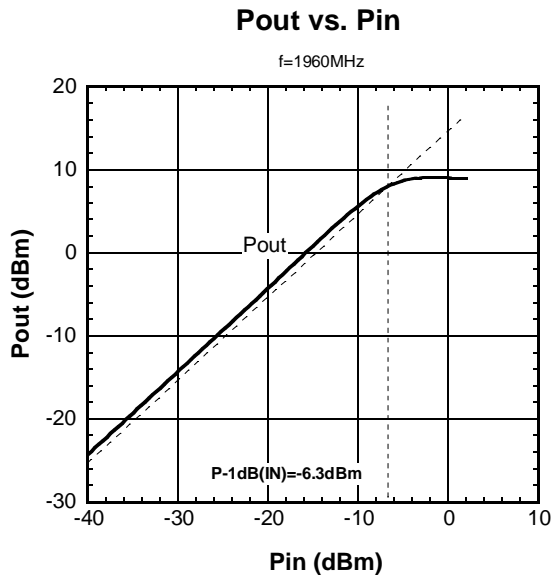

■ ELECTRICAL CHARACTERISTICS (PCS Band: LNA High Gain Mode)

(General Conditions: $V_{DD}=2.8V$, $V_{CTL1}=0V$, $V_{CTL2}=2.8V$, $f_{RF}=1960MHz$, $T_a=+25^\circ C$, $Z_s=Z_l=50\Omega$, with application circuit)

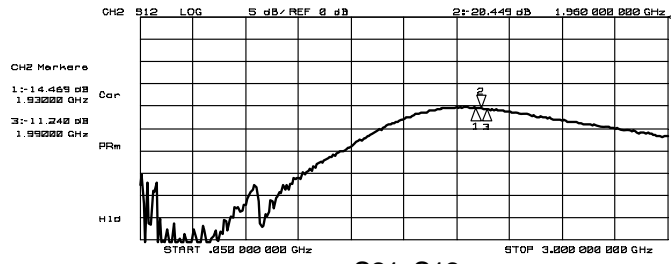
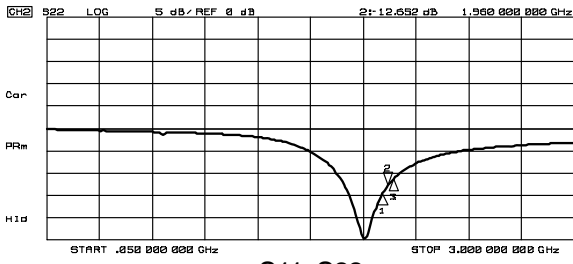
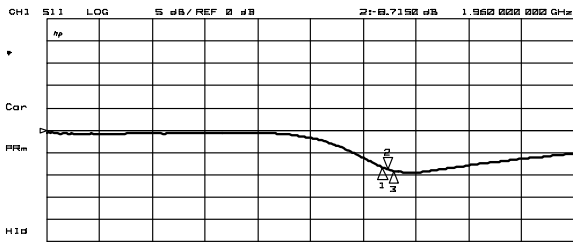

S11, S22

S21, S12

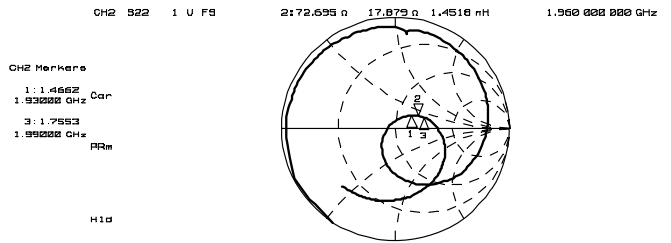
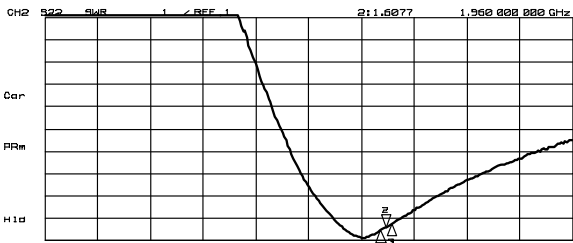
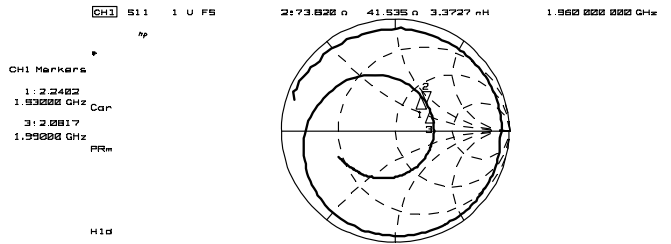
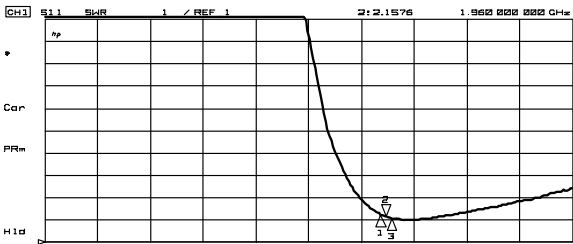

VSWR

Zin, Zout

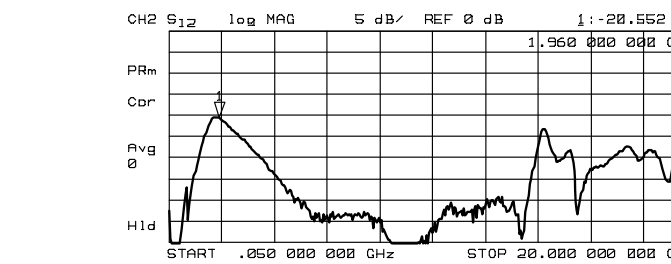
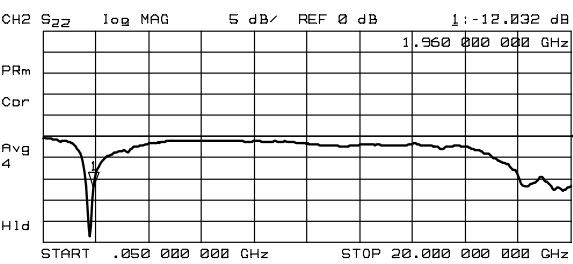
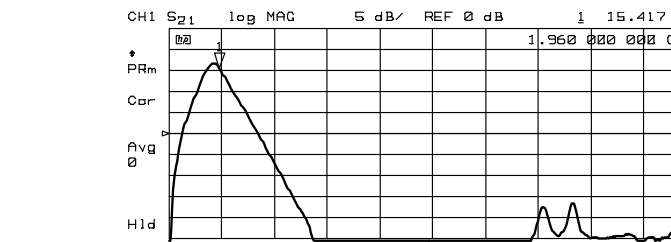
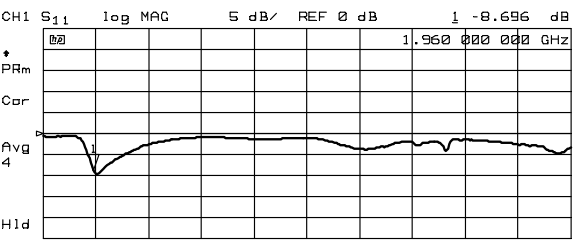

S11, S22 (~20GHz)

S21, S12 (~20GHz)

NJG1135MD7

■ ELECTRICAL CHARACTERISTICS (PCS Band: LNA High Gain Mode)

(General Conditions: $V_{DD}=2.8V$, $V_{CTL1}=0V$, $V_{CTL2}=2.8V$, $f_{RF}=1960MHz$, $Z_S=Z_L=50\Omega$, with application circuit)

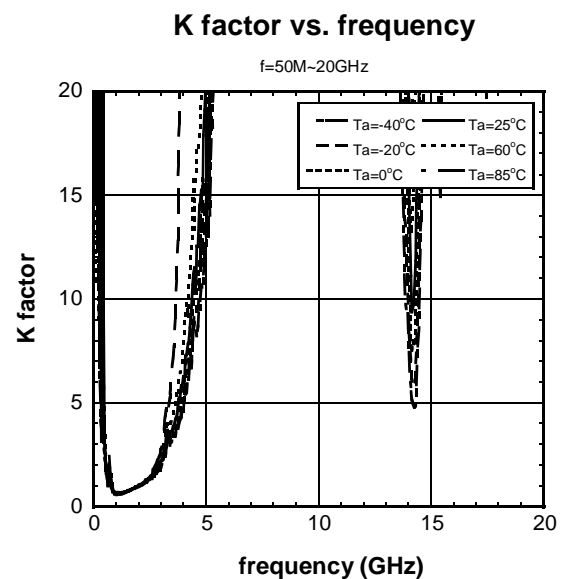
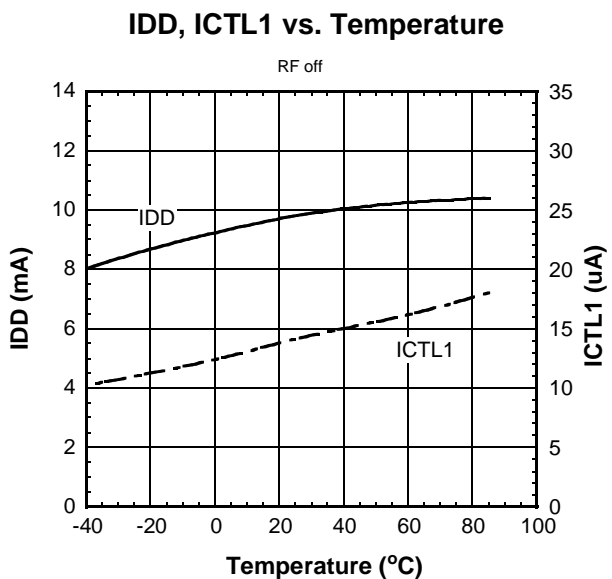
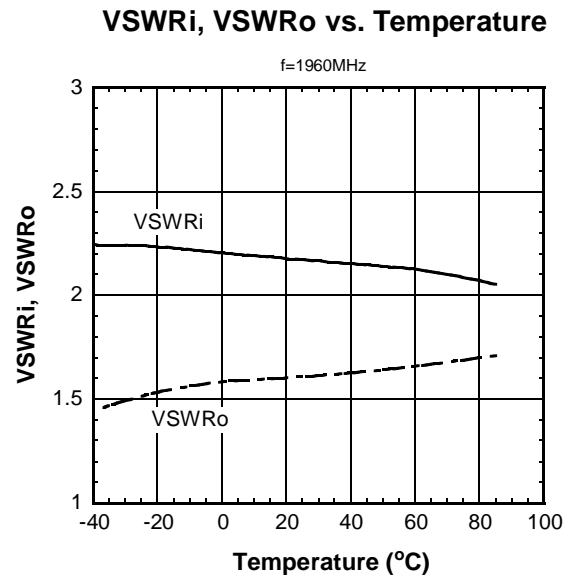
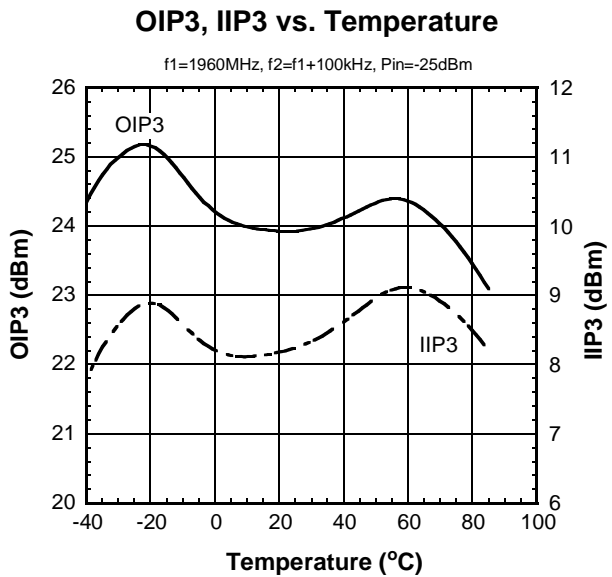
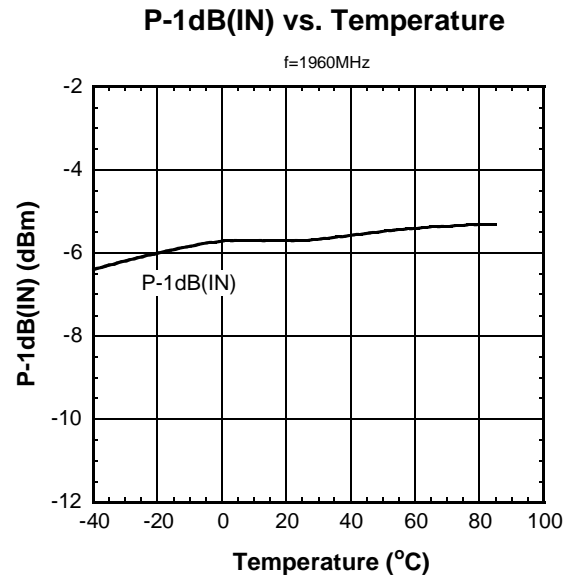
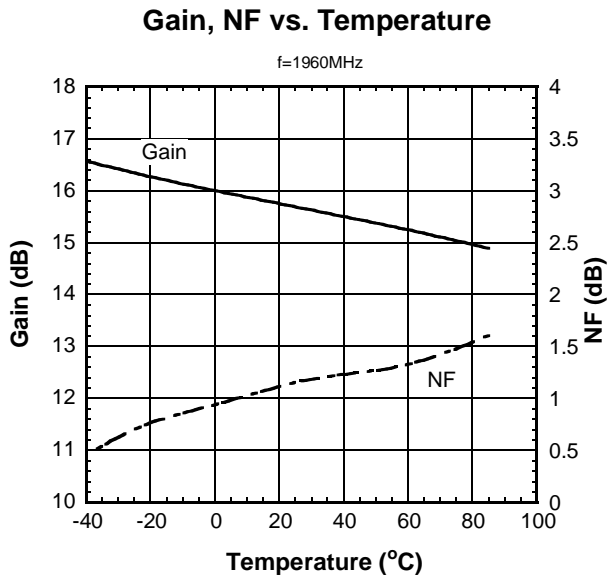

■ ELECTRICAL CHARACTERISTICS (PCS Band: LNA Low Gain Mode)

(General Conditions: $V_{DD}=2.8V$, $V_{CTL1}=0V$, $V_{CTL2}=2.8V$, $f_{RF}=1960MHz$, $T_a=+25^{\circ}C$, $Z_s=Z_l=50\Omega$, with application circuit)

Pout vs. Pin

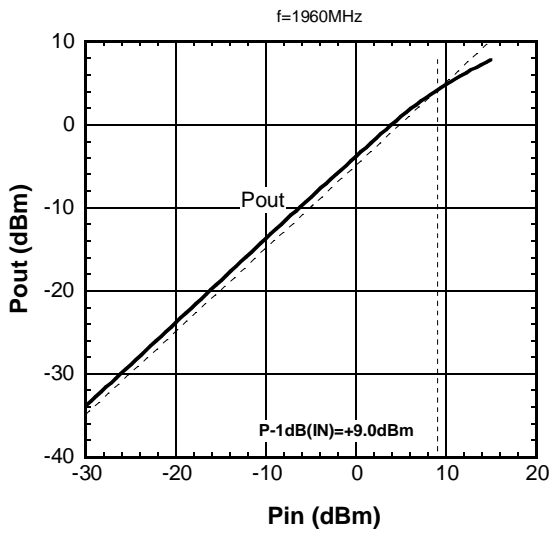

Gain, IDD vs. Pin

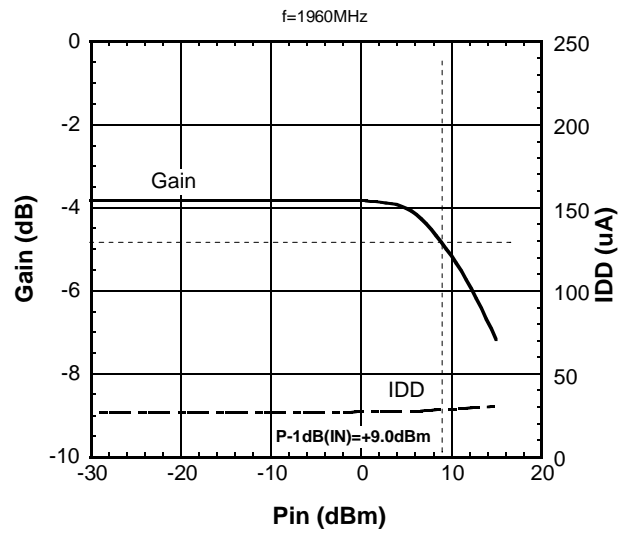

Pout, IM3 vs. Pin

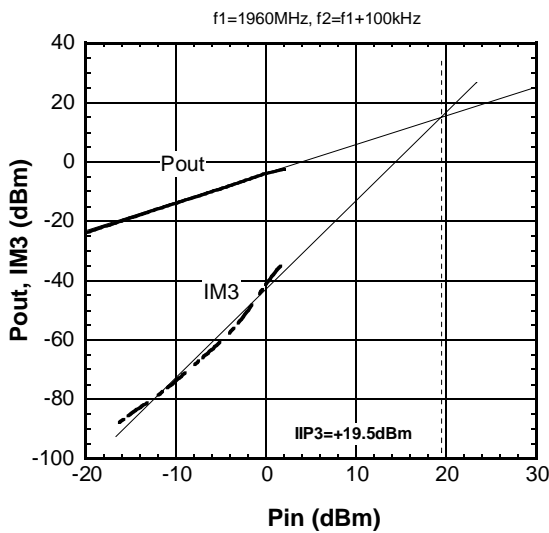

OIP3, IIP3 vs. frequency

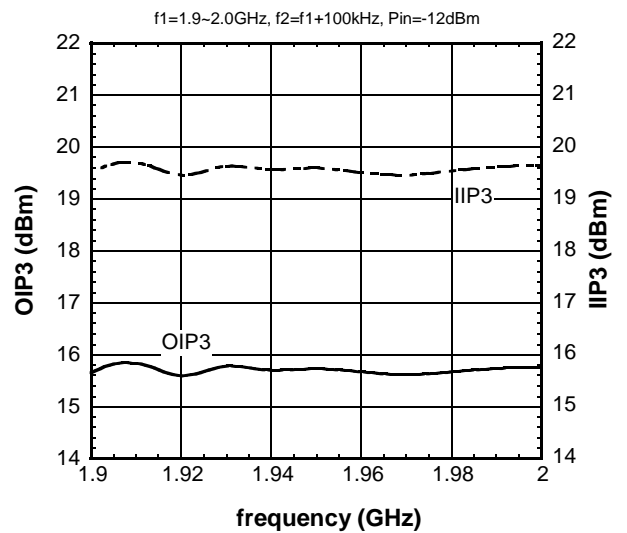

Gain, NF vs. frequency

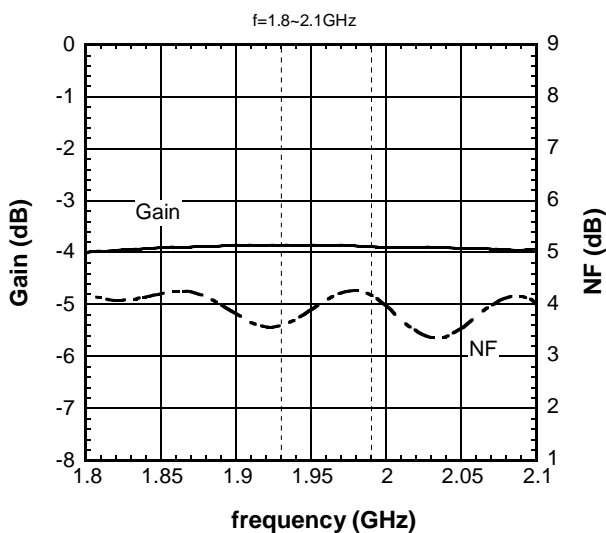

NJG1135MD7

ELECTRICAL CHARACTERISTICS (PCS Band: LNA Low Gain Mode)

(General Conditions: $V_{DD}=2.8V$, $V_{CTL1}=0V$, $V_{CTL2}=2.8V$, $f_{RF}=1960MHz$, $T_a=+25^{\circ}C$, $Z_s=Z_l=50\Omega$, with application circuit)

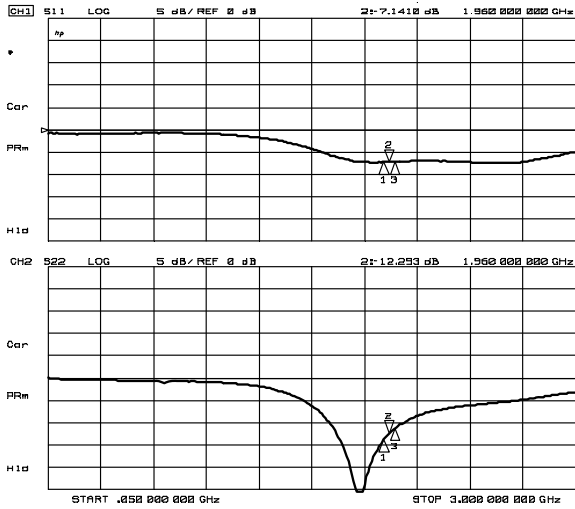

S11, S22

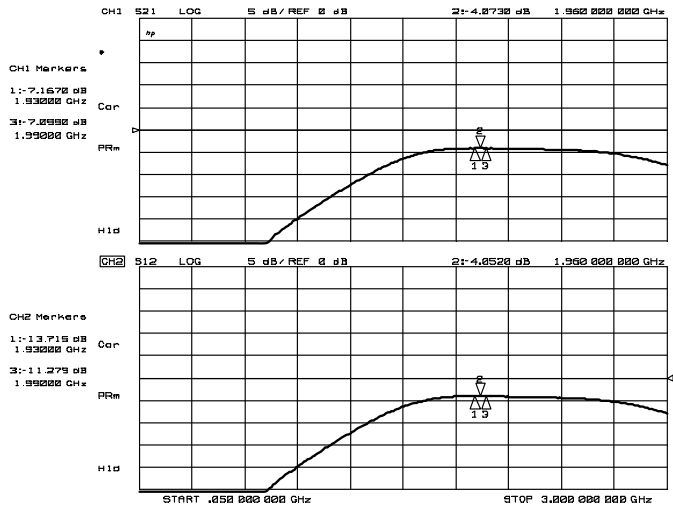

S21, S12

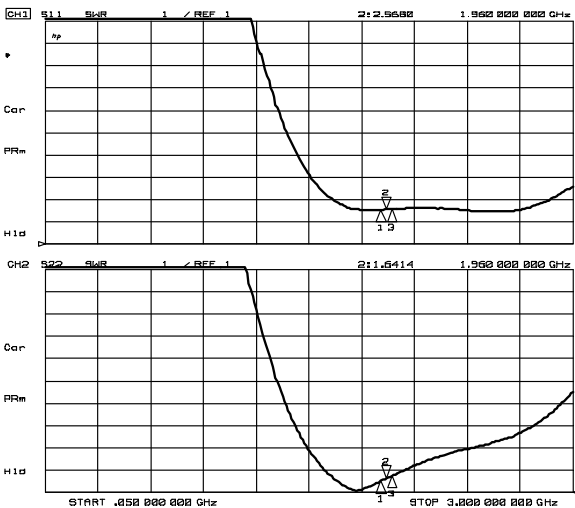

VSWR

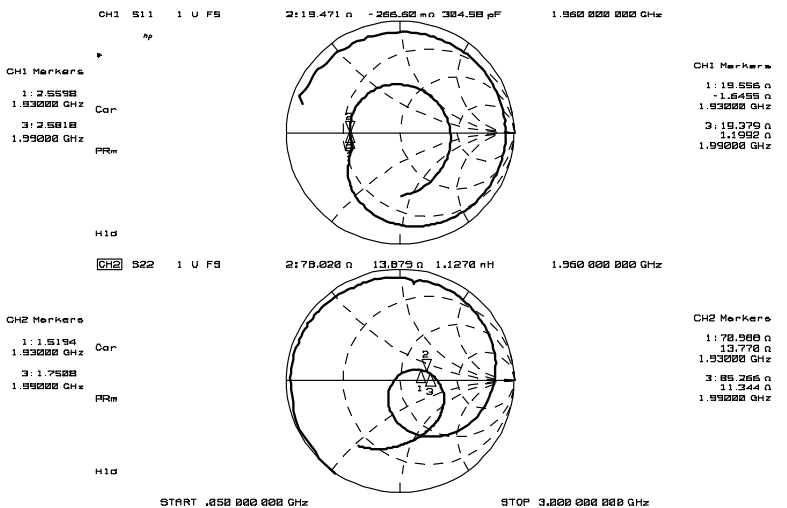

Zin, Zout

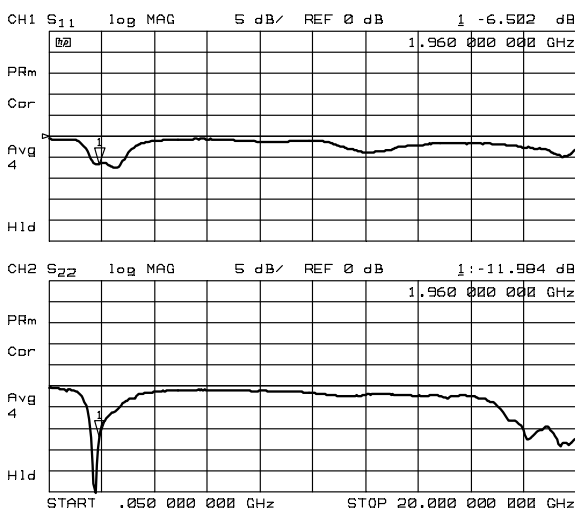

S11, S22 (~20GHz)

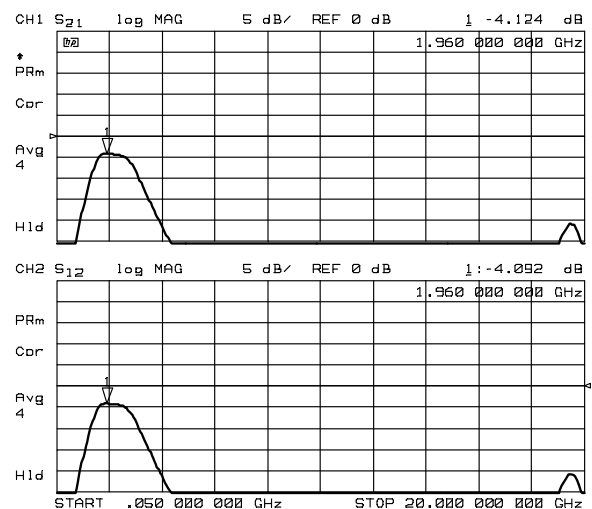

S21, S12 (~20GHz)

■ ELECTRICAL CHARACTERISTICS (PCS Band: LNA Low Gain Mode)

(General Conditions: $V_{DD}=2.8V$, $V_{CTL1}=0V$, $V_{CTL2}=2.8V$, $f_{RF}=1960MHz$, $Z_s=Z_l=50\Omega$, with application circuit)

Gain, NF vs. Temperature

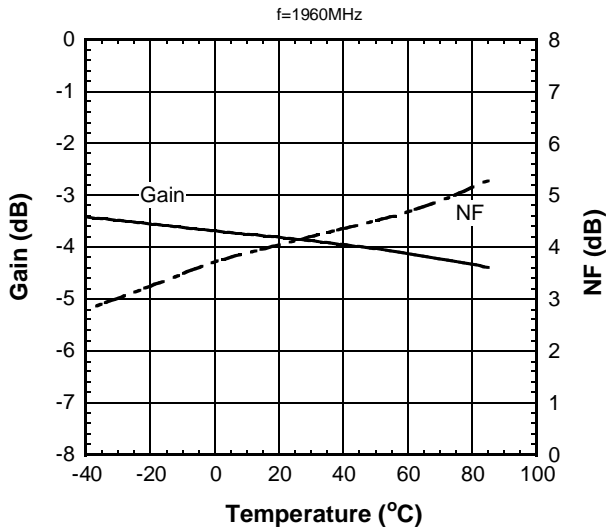

P-1dB(IN) vs. Temperature

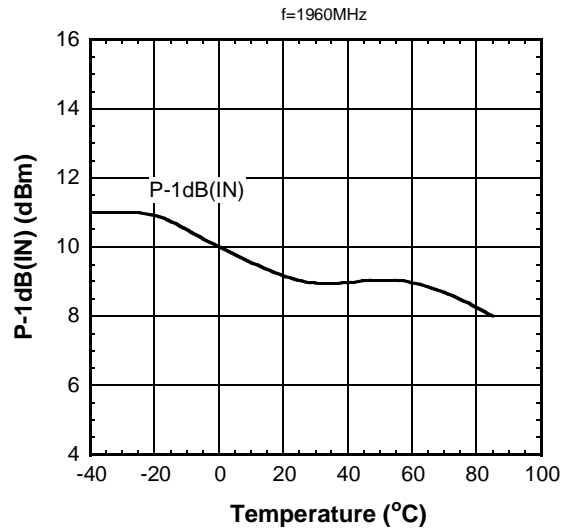

OIP3, IIP3 vs. Temperature

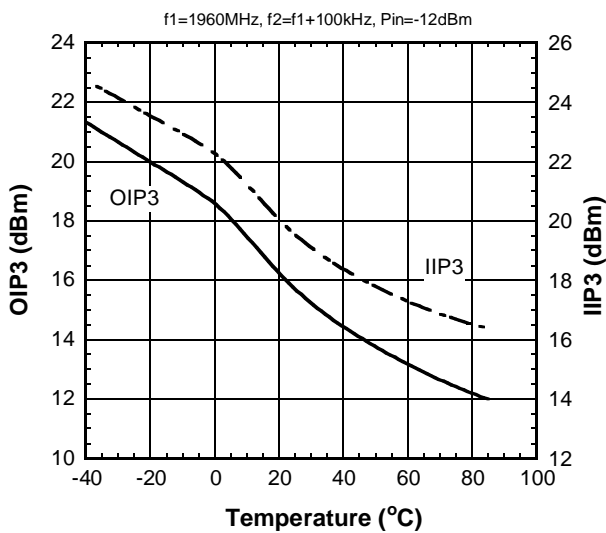

VSWRi, VSWRo vs. Temperature

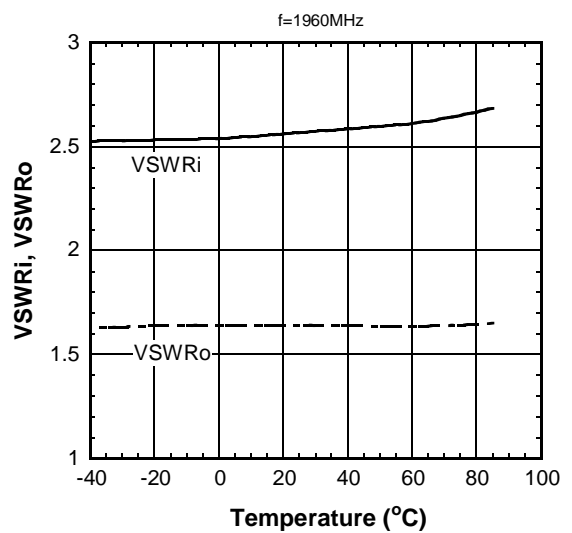

IDD vs. Temperature

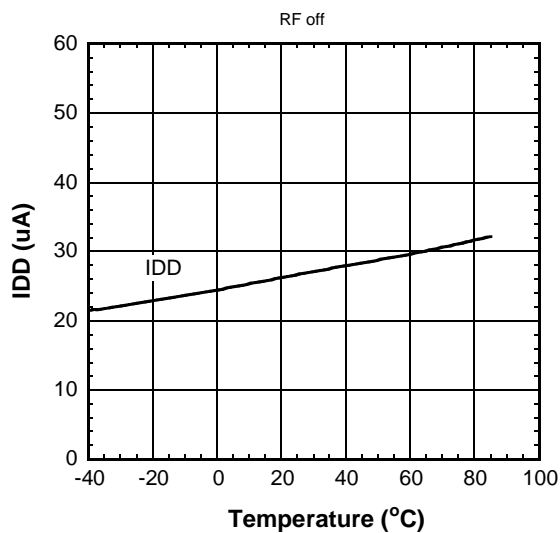

K factor vs. frequency

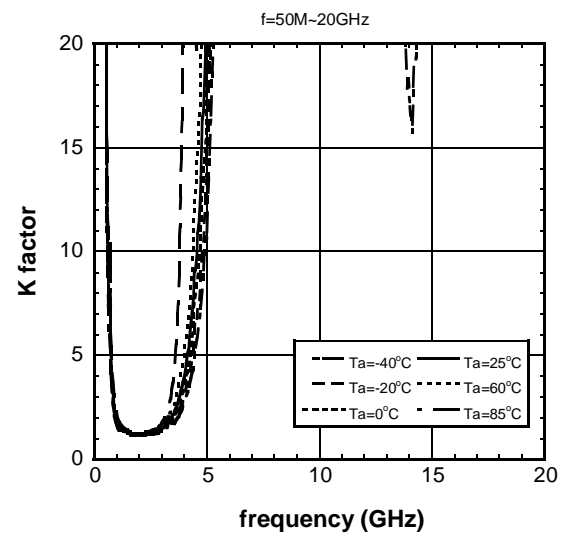

NJG1135MD7

APPLICATION CIRCUIT

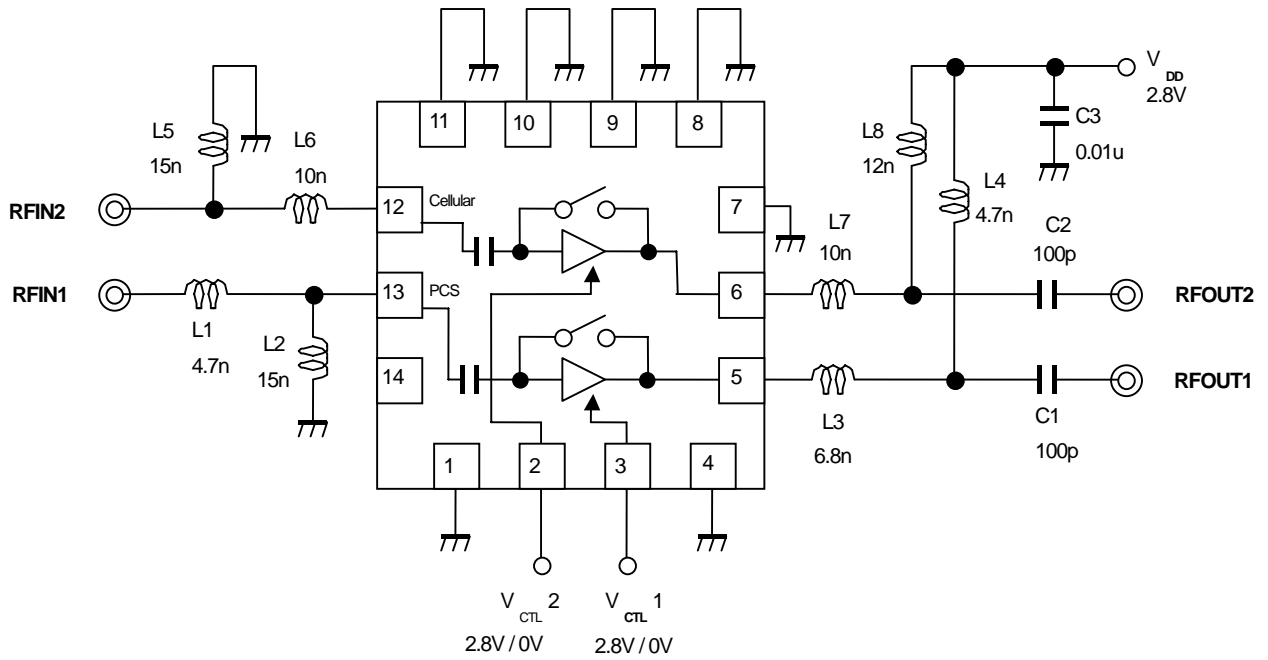

Parts list

Parts ID	Comments
L1, L2, L4	MURATA (LQP03T Series)
L3	TDK (MLK0603 Series)
L5~L8	TAIYO-YUDEN (HK1005 Series)
C1~C3	MURATA (GRM03 Series)

TEST PCB LAYOUT

(TOP VIEW)

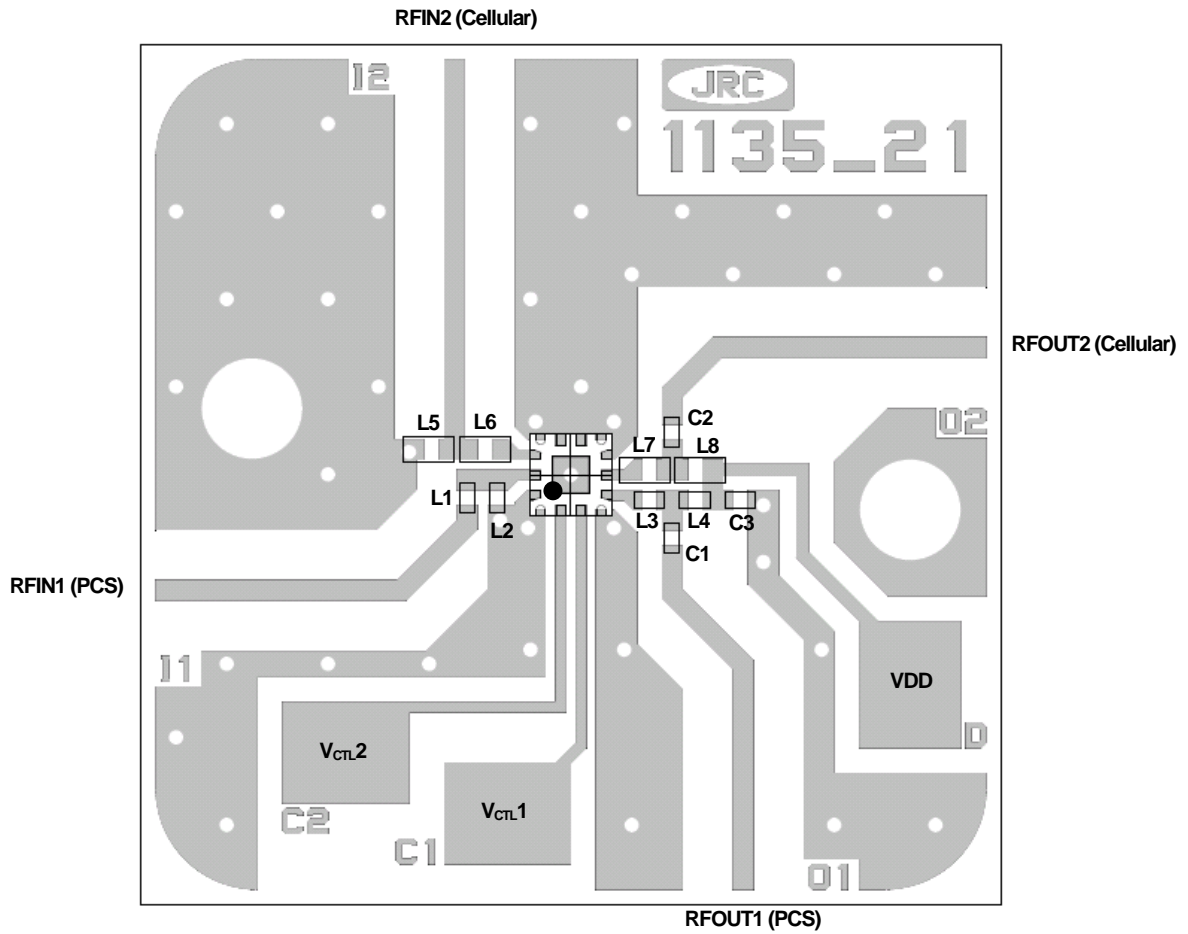

PCB (FR-4):
 t=0.2mm
 MICROSTRIP LINE WIDTH=0.4mm ($Z_0=50\text{ohm}$)
 PCB SIZE=17.0mm x 17.0mm

PRECAUTION:

In order not to couple with terminal RFIN and RFOUT, please layout ground pattern under the IC.

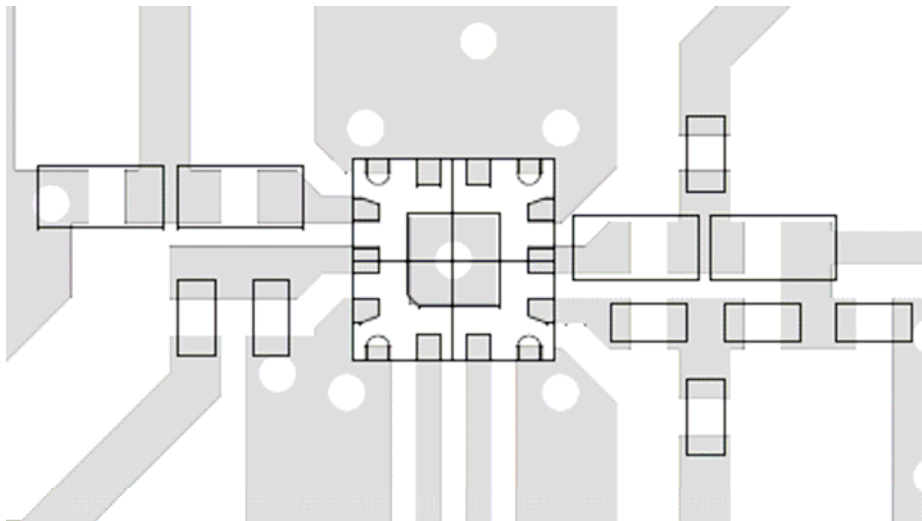

NJG1135MD7

PACKAGE OUTLINE (EQFN14-D7)

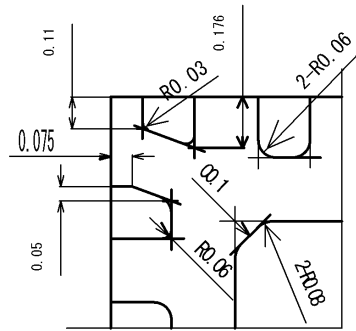
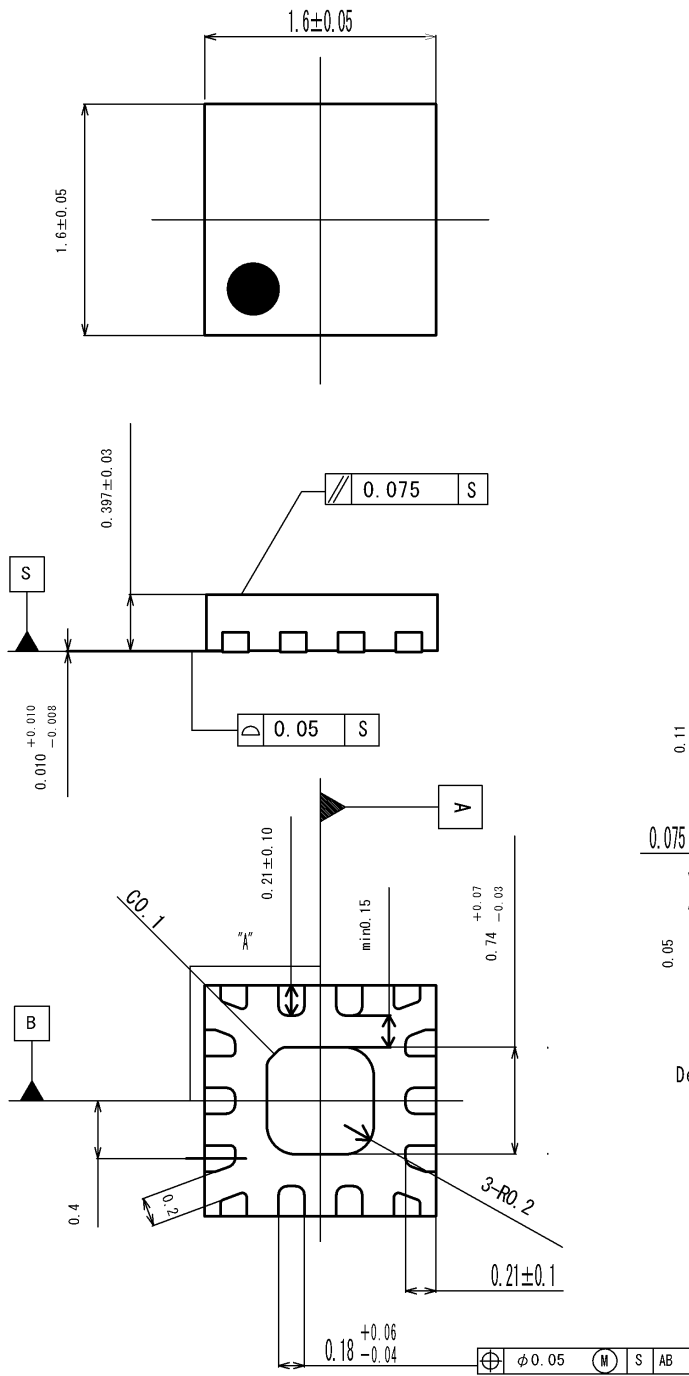

Details of "A" part (× 2)

UNIT : mm

SUBSTRATE MATERIAL : Copper
 TERMINAL FINISH : Sn-Bi plating
 MOLDE MATERIAL : Epoxy resin
 MASS (TYP.) : 0.0034 (g)

Cautions on using this product

This product contains Gallium-Arsenide (GaAs) which is a harmful material.

- Do NOT eat or put into mouth.
- Do NOT dispose in fire or break up this product.
- Do NOT chemically make gas or powder with this product.
- To waste this product, please obey the relating law of your country.

[CAUTION]

The specifications on this databook are only given for information, without any guarantee as regards either mistakes or omissions. The application circuits in this databook are described only to show representative usages of the product and not intended for the guarantee or permission of any right including the industrial rights.

This product may be damaged with electric static discharge (ESD) or spike voltage. Please handle with care to avoid these damages.