

Solid State Relays

G3NA

The reliable choice for Hockey-puck-style Solid State Relays. Available in a wide Range of Currents and Voltage. (5 to 90A, max 660 VAC)



- All models feature the same compact dimensions to provide a uniform mounting pitch.
- Operation indicator enables monitoring operation.
- Protective cover for greater safety.
- Built-in varistor effectively absorbs external surges. (except G3NA-D210B)
- Standard models certified by UL and CSA
–UTU models by also TÜV (except G3NA-420B, 610B, 625B, 650B)

For the most recent information on models that have been certified for safety standards, refer to your OMRON website.



Refer to *Safety Precautions for All Solid State Relays*.

Model Number Structure

■ Model Number Legend

G3NA- □ □ □ □ □ - □ - □
1 2 3 4 5 6 7 8

1. Basic Model Name

G3NA: Solid State Relay

2. Load Power Supply

Blank: AC output

D: DC output

3. Rated Load Power Supply Voltage

2: 200 VAC or 200 VDC

4: 400 VAC

6: 600 VAC

4. Rated Load Current

05: 5 A

10: 10 A

20: 20 A

25: 25 A

40: 40 A

50: 50 A

75: 75 A

90: 90 A

5. Terminal Type

B: Screw terminals

6. Zero Cross Function

Blank: Equipped with zero cross function (AC-output models only)

7. Certification

Blank: Standard models (certified by UL and CSA)

UTU: Certified by UL, CSA, and TÜV

8. RoHS Conformance

Blank, 2: RoHS conformance each type (All products are RoHS conformance)

Ordering Information

List of Models

Isolation	Zero cross function	LED Indicator	Applicable output load (See note 1)	Rated input voltage	Model
Phototriac Coupler	Yes	Yes	5 A at 24 to 240 VAC (See note 2.)	5 to 24 VDC	G3NA-205B DC5-24
Photocoupler				100 to 120 VAC	G3NA-205B AC100-120
				200 to 240 VAC	G3NA-205B AC200-240
Phototriac Coupler			10 A at 24 to 240 VAC (See note 2.)	5 to 24 VDC	G3NA-210B DC5-24
Photocoupler				100 to 120 VAC	G3NA-210B AC100-120
				200 to 240 VAC	G3NA-210B AC200-240
Phototriac Coupler			20 A at 24 to 240 VAC (See note 2.)	5 to 24 VDC	G3NA-220B DC5-24
Photocoupler				100 to 120 VAC	G3NA-220B AC100-120
				200 to 240 VAC	G3NA-220B AC200-240
Phototriac Coupler			25 A at 24 to 240 VAC (See note 2.)	5 to 24 VDC	G3NA-225B DC5-24
Photocoupler				100 to 120 VAC	G3NA-225B AC100-120
				200 to 240 VAC	G3NA-225B AC200-240
Phototriac Coupler			40 A at 24 to 240 VAC (See note 2.)	5 to 24 VDC	G3NA-240B DC5-24
Photocoupler				100 to 120 VAC	G3NA-240B AC100-120
				200 to 240 VAC	G3NA-240B AC200-240
Phototriac Coupler			50 A at 24 to 240 VAC (See note 2.)	5 to 24 VDC	G3NA-250B-UTU DC5-24
Photocoupler				100 to 120 VAC	G3NA-250B-UTU AC100-120
				200 to 240 VAC	G3NA-250B-UTU AC200-240
Phototriac Coupler			75 A at 24 to 240 VAC (See note 2.)	5 to 24 VDC	G3NA-275B-UTU-2 DC5-24
Photocoupler				100 to 240 VAC	G3NA-275B-UTU-2 AC100-120
				90 A at 24 to 240 VAC (See note 2.)	5 to 24 VDC
Photocoupler			100 to 240 VAC	G3NA-290B-UTU-2 AC100-120	
			10 A at 200 to 480 VAC	5 to 24 VDC	G3NA-410B DC5-24
Photocoupler				100 to 240 VAC	G3NA-410B AC100-240
			20 A at 200 to 480 VAC	5 to 24 VDC	G3NA-420B DC5-24
Photocoupler				100 to 240 VAC	G3NA-420B AC100-240
			25 A at 200 to 480 VAC	5 to 24 VDC	G3NA-425B-2 DC5-24
Photocoupler				100 to 240 VAC	G3NA-425B-2 AC100-240
			40 A at 200 to 480 VAC	5 to 24 VDC	G3NA-440B-2 DC5-24
Photocoupler				100 to 240 VAC	G3NA-440B-2 AC100-240
	50 A at 200 to 480 VAC	5 to 24 VDC	G3NA-450B-UTU-2 DC5-24		
Photocoupler		100 to 240 VAC	G3NA-450B-UTU-2 AC100-240		
	75 A at 200 to 480 VAC	5 to 24 VDC	G3NA-475B-UTU-2 DC5-24		
Photocoupler		100 to 240 VAC	G3NA-475B-UTU-2 AC100-240		
	90 A at 200 to 480 VAC	5 to 24 VDC	G3NA-490B-UTU-2 DC5-24		
Photocoupler		100 to 240 VAC	G3NA-490B-UTU-2 AC100-240		
	10 A at 400 to 600 VAC	5 to 24 VDC	G3NA-610B DC5-24		
Photocoupler		100 to 240 VAC	G3NA-610B AC100-240		
	25 A at 400 to 600 VAC	5 to 24 VDC	G3NA-625B DC5-24		
Photocoupler		100 to 240 VAC	G3NA-625B AC100-240		
	50 A at 400 to 600 VAC	5 to 24 VDC	G3NA-650B DC5-24		
Photocoupler		100 to 240 VAC	G3NA-650B AC100-240		
	10 A at 5 to 200 VDC	5 to 24 VDC	G3NA-D210B DC5-24		
Photocoupler		100 to 240 VAC	G3NA-D210B AC100-240		

* The standard models are certified by UL and CSA.

To order a TÜV-certified model, add "-UTU" to the model number as shown below:

Example: G3NA-210B-UTU DC5-24.

Note: 1. The applicable load is the value for when the SSR is used with silicon grease applied to the specified heat sink.

The applicable load depends on the ambient temperature. Refer to Load Current vs. Ambient Temperature in Engineering Data on page 6.

2. Loss time increases under 75 VAC. (Refer to page 18.) Confirm operation with the actual load.

Ordering Information

■ Accessories (Order Separately)

DIN Track Mounting Plate

Model
R99-12 FOR G3NA

Heat Sinks

DIN-track Mounting and Panel Mounting

Model	Applicable SSR
Y92B-N50	G3NA-205B, G3NA-210B, G3NA-410B, G3NA-610B, G3NA-D210B
Y92B-N100	G3NA-220B, G3NA-420B
Y92B-N150	G3NA-225B, G3NA-240B, G3NA-425B-2, G3NA-440B-2, G3NA-625B
Y92B-P250N	G3NA-250B-UTU, G3NA-450B-UTU-2, G3NA-650B
Y92B-P250NF	G3NA-275B-UTU-2, G3NA-290B-UTU-2, G3NA-475B-UTU-2, G3NA-490B-UTU-2

Panel Mounting Models

Model	Applicable SSR
Y92B-A100	G3NA-205B, G3NA-210B, G3NA-220B, G3NA-410B, G3NA-420B, G3NA-425B-2, G3NA-610B, G3NA-D210B
Y92B-A150N	G3NA-225B, G3NA-240B, G3NA-425B-2, G3NA-440B-2, G3NA-625B
Y92B-P250	G3NA-250B-UTU, G3NA-450B-UTU-2, G3NA-650B
Y92B-A250	G3NA-440B-2

Specifications

■ Ratings

Input (at an Ambient Temperature of 25°C)

Model	Rated voltage	Operating voltage	Impedance (See note 1.)	Voltage level	
				Must operate voltage	Must release voltage
G3NA-2□□B	5 to 24 VDC	4 to 32 VDC	7 mA max. (See note 2.)	4 VDC max.	1 VDC min.
	100 to 120 VAC	75 to 132 VAC	36 kΩ±20% (See note 4.)	75 VAC max. (See note 3.)	20 VAC min. (See note 3.)
	200 to 240 VAC	150 to 264 VAC	72 kΩ±20%	150 VAC max. (See note 3.)	40 VAC min. (See note 3.) (See note 5.)
G3NA-4□□B G3NA-D210B	5 to 24 VDC	4 to 32 VDC	5 mA max.	4 VDC max.	1 VDC min.
	100 to 120 VAC	75 to 264 VAC	72 kΩ±20%	75 VAC max.	20 VAC min.
G3NA-250B-UTU G3NA-275B-UTU-2 G3NA-290B-UTU-2	5 to 24 VDC	4 to 32 VDC	15 mA max.	4 VDC max.	1 VDC min.
	100 to 240 VAC	75 to 264 VAC	72 kΩ±20%	75 VAC max.	20 VAC min.
G3NA-450B-UTU-2 G3NA-475B-UTU-2 G3NA-490B-UTU-2 G3NA-6□□B	5 to 24 VDC	4 to 32 VDC	7 mA max.	4 VDC max.	1 VDC min.
	100 to 240 VAC	75 to 264 VAC	72 kΩ±20%	75 VAC max.	20 VAC min.

- Note:**
1. The input impedance is measured at the maximum value of the rated supply voltage (for example, with the model rated at 100 to 120 VAC, the input impedance is measured at 120 VAC).
 2. With constant current input circuit system. The impedance for the G3NA-2□□B-UTU is 15 mA max.
 3. Refer to Temperature Characteristics (for Must Operate Voltage and Must Release Voltage) in Engineering Data on page 7 for further details.
 4. The G3NA-240B-UTU is 72kΩ±20%.
 5. The G3NA-240B-UTU is 20 VAC min.

Output

Model	Rated load voltage	Load voltage range	Load current (See note 1.)		Inrush current
			With heat sink (See note 2.)	Without heat sink	
G3NA-205B	24 to 240 VAC	19 to 264 VAC	0.1 to 5 A (at 40°C)	0.1 to 3 A (at 40°C)	60 A (60 Hz, 1 cycle)
G3NA-210B			0.1 to 10 A (at 40°C)	0.1 to 4 A (at 40°C)	150 A (60 Hz, 1 cycle)
G3NA-220B			0.1 to 20 A (at 40°C)	0.1 to 4 A (at 40°C)	220 A (60 Hz, 1 cycle)
G3NA-225B			0.1 to 25 A (at 40°C)	0.1 to 4 A (at 40°C)	220 A (60 Hz, 1 cycle)
G3NA-240B			0.1 to 40 A (at 40°C)	0.1 to 6 A (at 40°C)	440 A (60 Hz, 1 cycle)
G3NA-250B-UTU			0.1 to 50 A (at 40°C)	0.1 to 6 A (at 40°C)	440 A (60 Hz, 1 cycle)
G3NA-275B-UTU-2			1 to 75 A (at 40°C)	1 to 7 A (at 40°C)	800 A (60 Hz, 1 cycle)
G3NA-290B-UTU-2			1 to 90 A (at 40°C)	1 to 7 A (at 40°C)	1,000 A (60 Hz, 1 cycle)
G3NA-410B	200 to 480 VAC	180 to 528 VAC	0.2 to 10 A (at 40°C)	0.2 to 4 A (at 40°C)	150 A (60 Hz, 1 cycle)
G3NA-420B			0.2 to 20 A (at 40°C)	0.2 to 4 A (at 40°C)	220 A (60 Hz, 1 cycle)
G3NA-425B-2			0.2 to 25 A (at 40°C)	0.2 to 4 A (at 40°C)	220 A (60 Hz, 1 cycle)
G3NA-440B-2			0.2 to 25 A (at 40°C)	0.2 to 6 A (at 40°C)	440 A (60 Hz, 1 cycle)
G3NA-450B-UTU-2			0.2 to 50 A (at 40°C)	0.2 to 6 A (at 40°C)	440 A (60 Hz, 1 cycle)
G3NA-475B-UTU-2			1 to 75 A (at 40°C)	1 to 7 A (at 40°C)	800 A (60 Hz, 1 cycle)
G3NA-490B-UTU-2			1 to 90 A (at 40°C)	1 to 7 A (at 40°C)	1,000 A (60 Hz, 1 cycle)
G3NA-610B	400 to 600 VAC	360 to 660 VAC	0.5 to 10 A (at 40°C)	0.5 to 4 A (at 40°C)	150 A (60 Hz, 1 cycle)
G3NA-625B			0.5 to 25 A (at 40°C)	0.5 to 4 A (at 40°C)	220 A (60 Hz, 1 cycle)
G3NA-650B			0.5 to 50 A (at 40°C)	0.5 to 6 A (at 40°C)	440 A (60 Hz, 1 cycle)
G3NA-D210B	5 to 200 VDC	4 to 220 VDC	0.1 to 10 A (at 40°C)	0.1 to 4 A (at 40°C)	20 A (10 ms)

- Note:**
1. The load current varies depending on the ambient temperature. Refer to Load Current vs. Ambient Temperature under Engineering Data.
 2. When an OMRON Heat Sink (refer to page 9-12) or a heat sink of the specified size is used.

Specifications

■ Characteristics

Model	G3NA-205B, 210B, 220B, 225B	G3NA-240B, 250B-UTU	G3NA-275B-UTU-2, 290B-UTU-2	G3NA-410B, 420B, 425B-2, 440B-2, 450B-UTU-2	G3NA-475B-UTU-2, 490B-UTU-2	G3NA-610B, 625B, 650B	G3NA-D210B
Operate time	1/2 of load power source cycle + 1 ms max. (DC input) 3/2 of load power source cycle + 1 ms max. (AC input)						1 ms max. (DC input) 30 ms max. (AC input)
Release time	1/2 of load power source cycle + 1 ms max. (DC input) 3/2 of load power source cycle + 1 ms max. (AC input)						5 ms max. (DC input) 30 ms max. (AC input)
Output ON voltage drop	1.6 V (RMS) max.			1.8 V (RMS) max.		1.5 V max.	
Leakage current	5 mA max. (at 100 VAC) 10 mA max. (at 200 VAC)			10 mA max. (at 200 VAC) 20 mA max. (at 400 VAC)		10 mA max. (at 400 VAC) 20 mA max. (at 600 VAC)	5 mA max. (at 200 VDC)
Insulation resistance	100 MΩ min. (at 500 VDC)						
Dielectric strength	2,500 VAC, 50/60 Hz for 1 min		4,000 VAC, 50/60 Hz for 1 min	2,500 VAC, 50/60 Hz for 1 min	4,000 VAC, 50/60 Hz for 1 min		2,500 VAC, 50/60 Hz for 1 min
Vibration resistance	Destruction: 10 to 55 to 10 Hz, 0.75-mm single amplitude (1.5-mm double amplitude)						
Shock resistance	Destruction: 1,000 m/s ²						
Ambient temperature	Operating: -30°C to 80°C (with no icing or condensation) Storage: -30°C to 100°C (with no icing or condensation)						
Ambient humidity	Operating: 45% to 85%						
Weight	Approx. 60 g	Approx. 70 g	Approx. 120 g	Approx. 80 g	Approx. 120 g		Approx. 70 g

Engineering Data

Load Current vs. Ambient Temperature

G3NA-205B

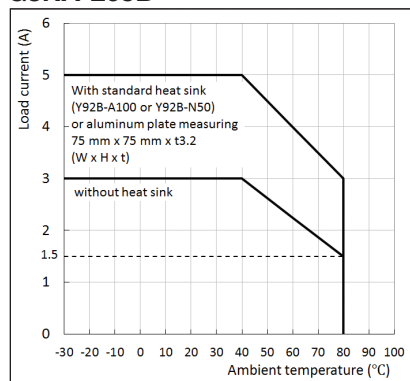

**G3NA-210B
G3NA-410B, G3NA-610B**

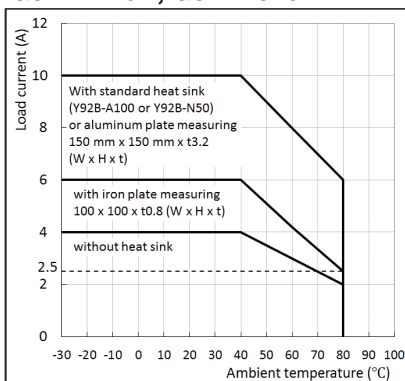

G3NA-220B, G3NA-420B

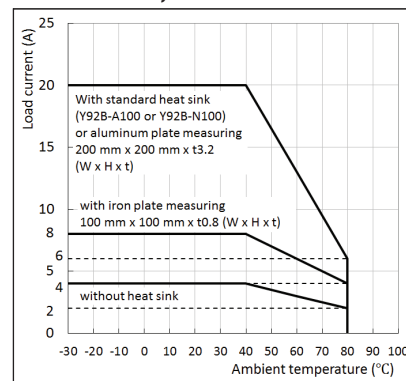

**G3NA-225B
G3NA-425B, G3NA-625B**

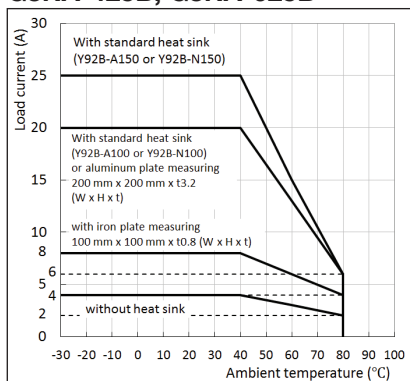

G3NA-240B

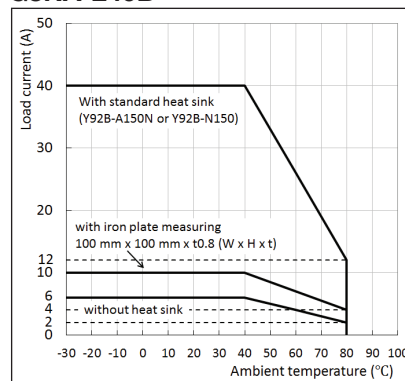

G3NA-440B-2

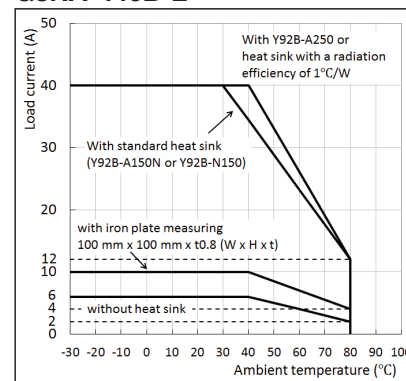

**G3NA-250B, G3NA-450B,
G3NA-650B**

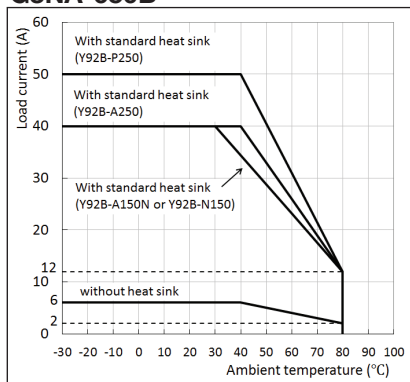

G3NA-275B, G3NA-475B

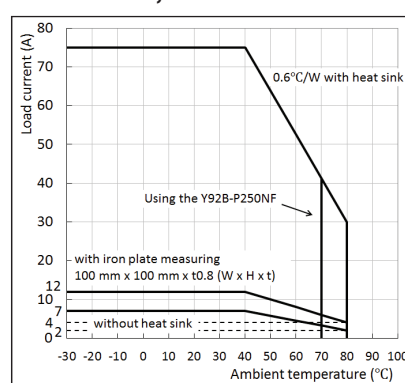

G3NA-290B, G3NA-490B

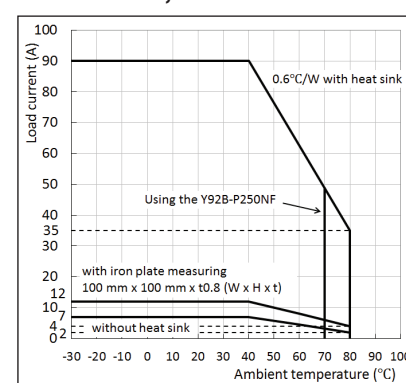

G3NA-D210B

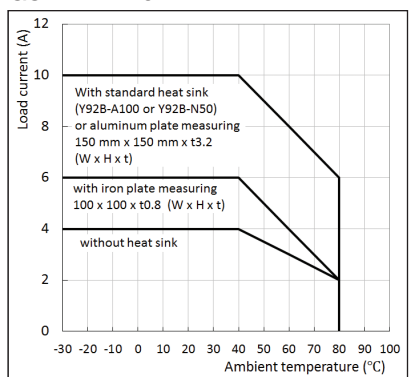

Engineering Data

One Cycle Surge Current

The values shown by the solid line are for non-repetitive inrush currents. Keep the inrush current below the values shown by the dotted line if it occurs repetitively.

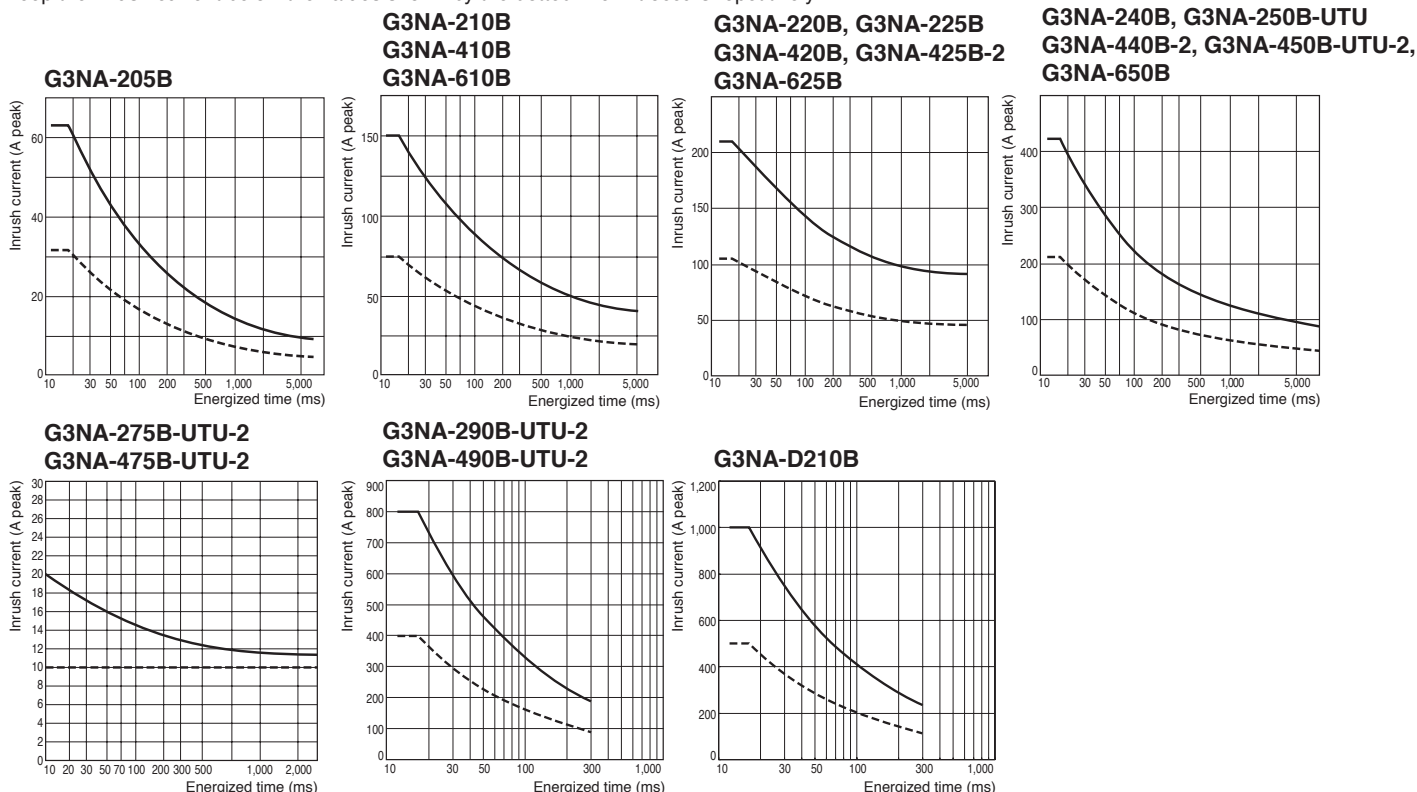

Temperature Characteristics

(for Must Operate Voltage and Must Release Voltage)

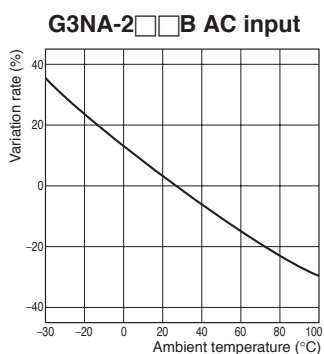

Heat Sink Area vs. Load Current

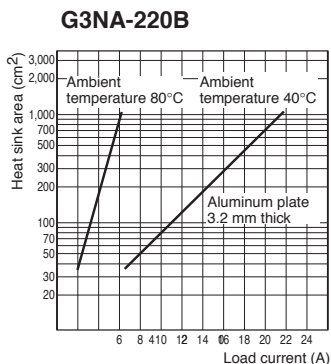

Note: The heat sink area refers to the combined area of the sides of the heat sink that radiate heat. For example, when a current of 18 A is allowed to flow through the SSR at 40°C, the graph shows that the heat sink area is about 450 cm². Therefore, if the heat sink is square, one side of the heat sink must be 15 cm ($\sqrt{450 \text{ (cm}^2\text{)}/2}$) or longer.

Thermal Resistance Rth (Back of Junction SSR) (Examples)

Model	Rth (°C/W)
G3NA-205B	3.22
G3NA-210B	2.62
G3NA-220B	1.99
G3NA-240B	0.45
G3NA-440B-2	
G3NA-250B-UTU	
G3NA-450B-UTU-2	
G3NA-275B-UTU-2	
G3NA-475B-UTU-2	
G3NA-290B-UTU-2	0.37
G3NA-490B-UTU-2	
G3NA-610B	
G3NA-625B	0.37
G3NA-650B	
G3NA-D210B	2.62

Thermal Resistance Rth of Heat Sinks (Examples)

Model	Rth (°C/W)
Y92B-N50	2.80
Y92B-N100	1.63
Y92B-N150	1.38
Y92B-A100	1.63
Y92B-A150N	1.37
Y92B-A250	1.00
Y92B-P250	0.70
Y92B-P250N	0.46
Y92B-P250NF	0.15

Note: When using a commercially available heat sink, use one with a thermal resistance equal to or less than the OMRON Heat Sink.

Dimensions

Relays

Note: All units are in millimeters unless otherwise indicated.

G3NA-205B, G3NA-210B, G3NA-220B, G3NA-225B,
G3NA-410B, G3NA-420B, G3NA-425B-2, G3NA-610B, G3NA-625B

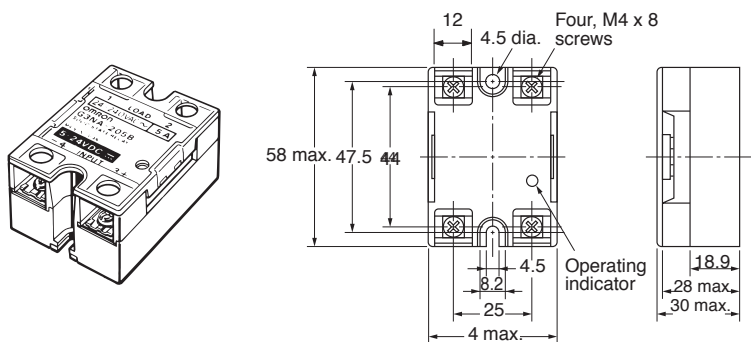

Mounting Holes

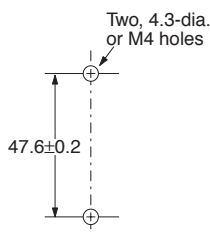

Terminal Arrangement/ Internal Connections (Top View)

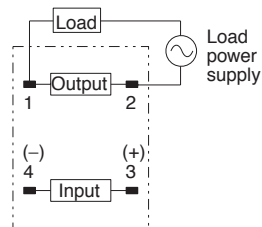

G3NA-240B, G3NA-250B-UTU, G3NA-275B-UTU-2, G3NA-290B-UTU-2
G3NA-440B-2, G3NA-450B-UTU-2, G3NA-475B-UTU-2, G3NA-490B-UTU-2, G3NA-650B

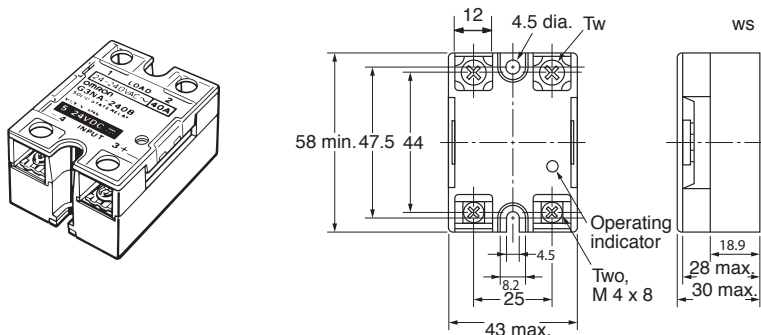

Mounting Holes

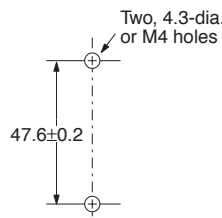

Terminal Arrangement/ Internal Connections (Top View)

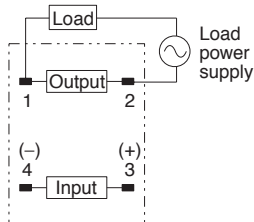

G3NA-D210B

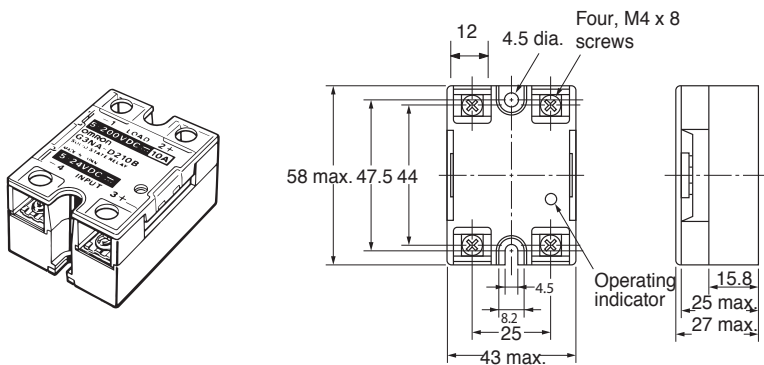

Mounting Holes

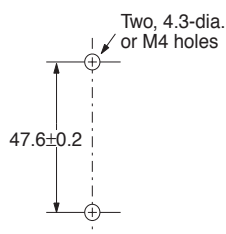

Terminal Arrangement/ Internal Connections (Top View)

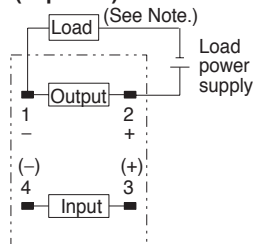

Note: When connecting the load, either the positive or negative side of the load terminals can be connected.

Dimensions

Options (Order Separately)

One-touch Mounting Plate

The One-touch Mounting Plate is used to mount the GN3A to a DIN Track.

R99-12 FOR G3NA (for the G3NA and G3NE)

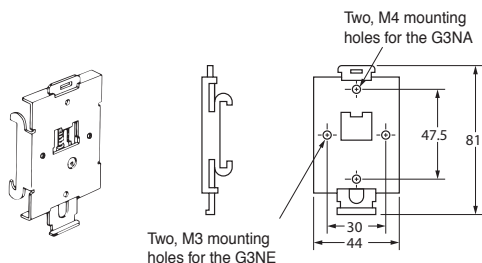

To mount the Relay to DIN Track, first mount it to the One-touch Mounting Plate and then attach it to the DIN Track as shown in the diagram.

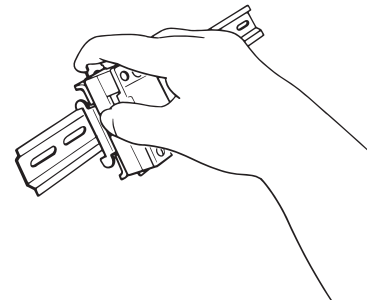

To remove the Relay from the DIN Track, pull down on the tab with a screwdriver in the direction of the arrow.

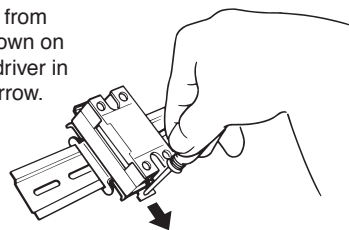

- When a Relay is mounted to DIN Track, use it within the rating for a Relay without a heat sink.
- Use the following DIN Tracks: PFP-50N, PFP-100N or PFP-100N2.

DIN-track Mounting and Panel Mounting Type Heat Sink

Y92B-N50 Heat Sink (for the G3NA-205B, G3NA-210B, G3NA-410B, G3NA-610B, G3NA-D210B)

For surface mounting, a 30% derating of the load current is required (from the *Load Current vs. Ambient Temperature* graphs). For mounting method, refer to "Precautions for Correct Use".

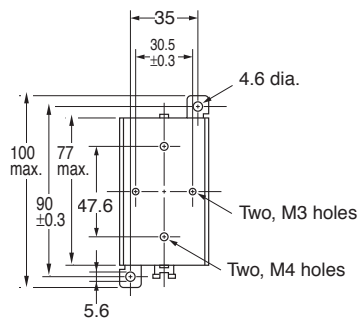
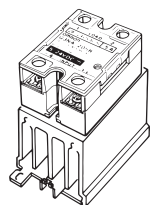

Mounting Holes

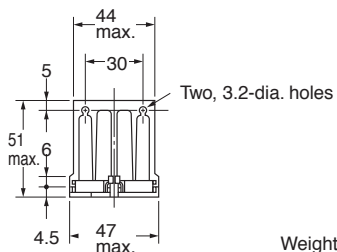
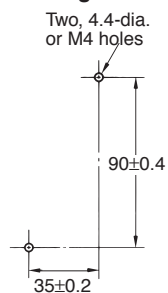

Weight: approx. 200 g

Dimensions

Y92B-N100 Heat Sink (G3NA-220B, G3NA-420B)

For surface mounting, a 30% derating of the load current is required (from the *Load Current vs. Ambient Temperature* graphs).
For mounting method, refer to "Precautions for Correct Use".

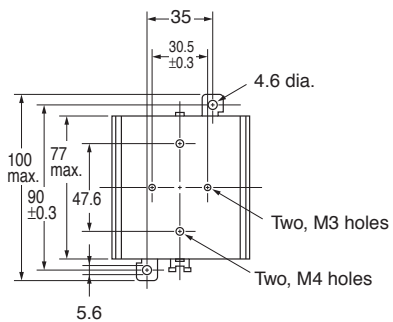
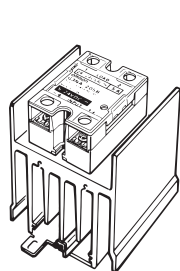

Mounting Holes

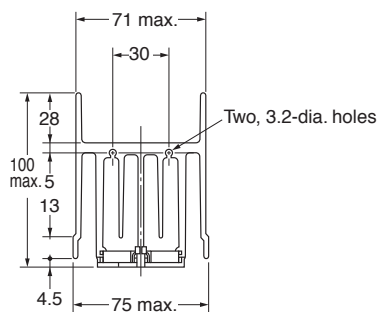
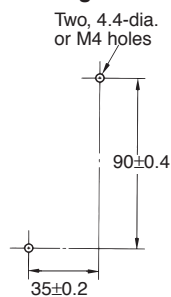

Weight: approx. 400 g

Y92B-N150 Heat Sink (for the G3NA-225B, G3NA-425B-2, G3NA-625B, G3NA-240B, G3NA-440B-2, G3NA-625B)

For surface mounting, a 30% derating of the load current is required (from the *Load Current vs. Ambient Temperature* graphs).
For mounting method, refer to "Precautions for Correct Use".

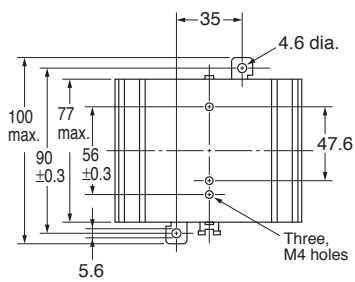
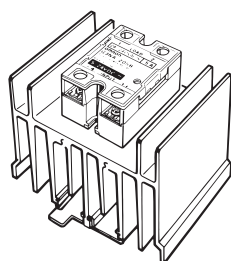

Mounting Holes

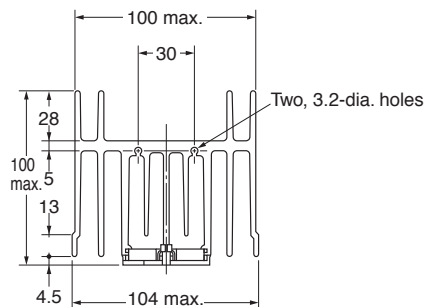
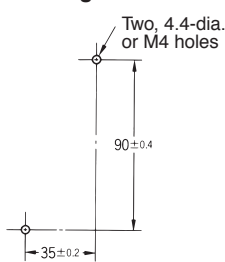

Weight: approx. 560 g

Dimensions

Y92B-P250N (for G3NA-250B-UTU, G3NA-450B-UTU-2, G3NA-650B)

Type G3NA-650B is recommended for max. 50 A with this heat sink.

For upright standing to the ground, a 30% derating of the load current is required (from the *Load Current vs. Ambient Temperature* graphs).

For mounting method, refer to "Precautions for Correct Use".

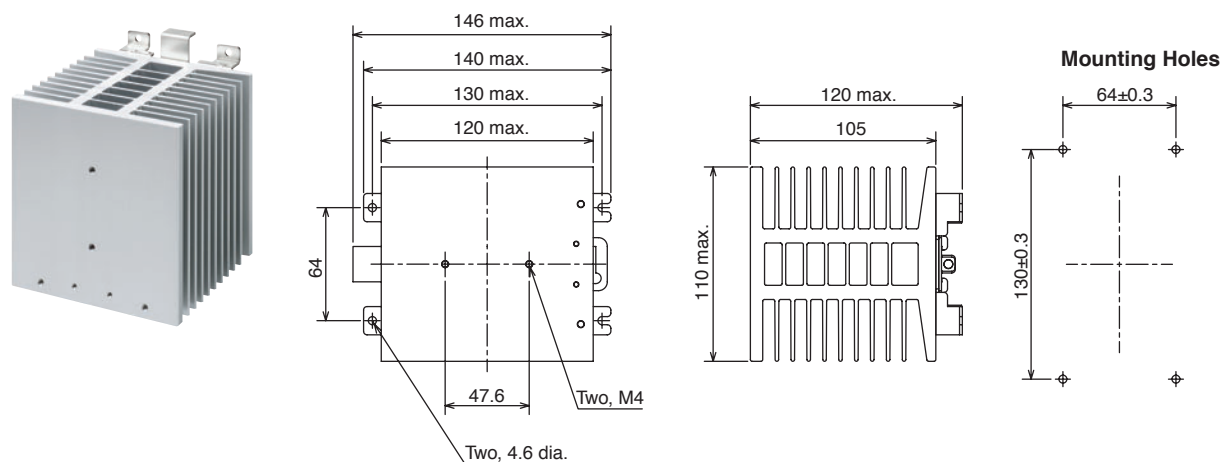

Y92B-P250NF Heat Sink (for the G3NA-275B-UTU-2, G3NA-475B-UTU-2, G3NA-290B-UTU-2, G3NA-490B-UTU-2)

For mounting method, refer to "Precautions for Correct Use".

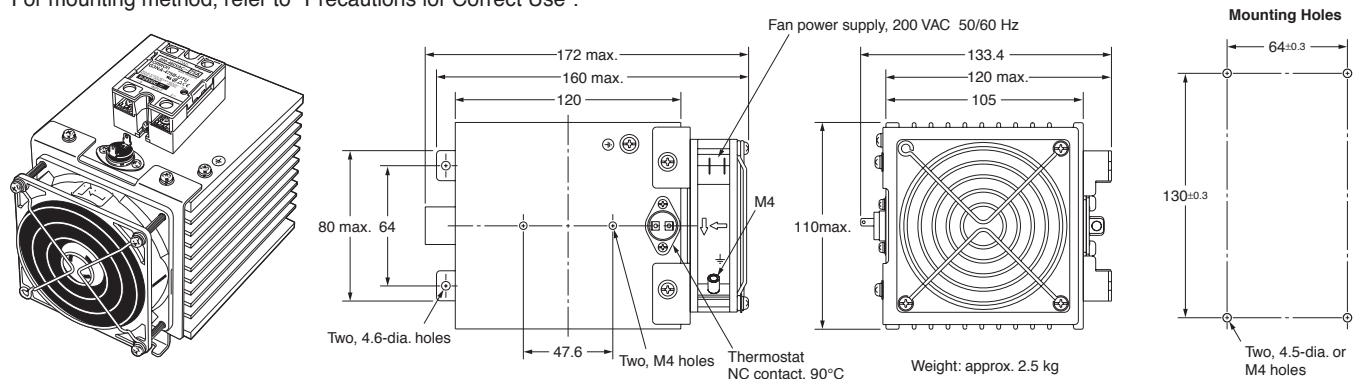

Dimensions

Y92B-A100 Heat Sink
(for the G3NA-205B,
G3NA-210B,
G3NA-220B,
G3NA-410B,
G3NA-420B,
G3NA-D210B)

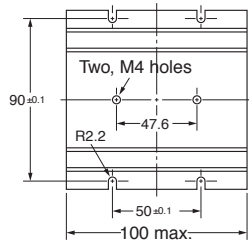

Weight: approx. 210 g

Y92B-A150N Heat Sink
(for the G3NA-225B,
G3NA-425B-2, G3NA-240B,
G3NA-440B-2, G3NA-625B)

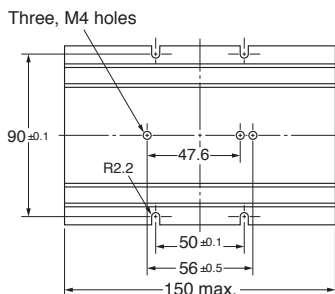

Weight: approx. 310 g

Y92B-A250 Heat Sink
(for the G3NA-440B-2)

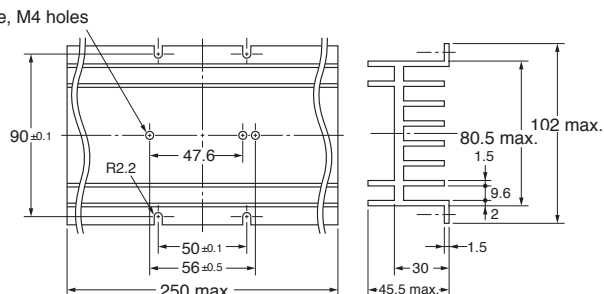

Weight: approx. 510 g

Mounting Holes
Y92B-A100
Y92B-A150
Y92B-A250

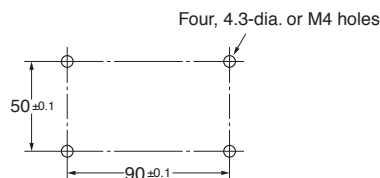

Panel Mounting Type Heat Sink

Y92B-P250 Heat Sink (for G3NA-250B-UTU, G3NA-450B-UTU-2, G3NA-650B)

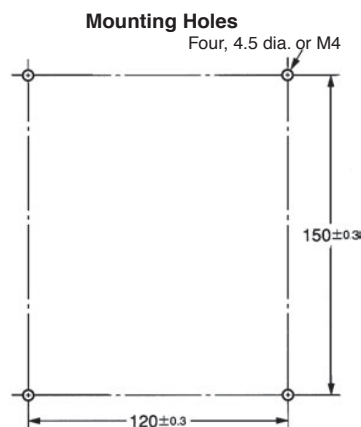
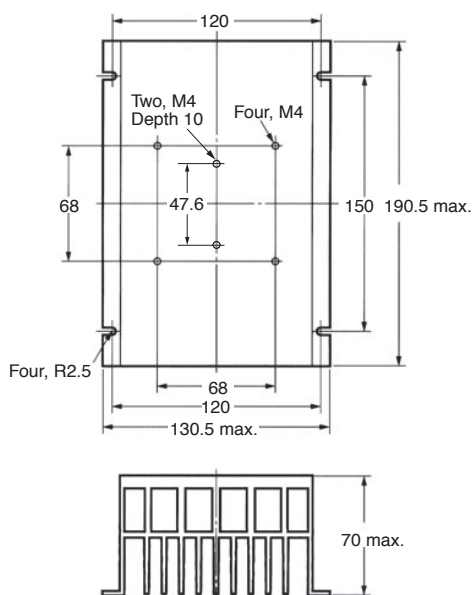

For surface mounting, a 30% derating of the load current is required (from the *Load Current vs. Ambient Temperature* graphs).
For mounting method, refer to "Precautions for Correct Use".

Approvals

■ UL (File No. E64562) / CSA (File No. LR35535)

SSR type	Input voltage	Load type	Contact ratings	
			Without heat sink	With heat sink (See note 1.)
G3NA-205B	5 to 24 VDC 100 to 120 VAC 200 to 240 VAC	General use/Tungsten	3 A, 240 VAC	5 A, 240 VAC
		Motor	2.5 FLA, 15 LRA, 240 VAC	2.5 FLA, 15 LRA, 240 VAC
G3NA-210B		General use/Tungsten	4 A, 240 VAC	10 A, 240 VAC
		Motor	2.5 FLA, 15 LRA, 240 VAC	5 FLA, 30 LRA, 240 VAC
G3NA-220B		General use/Tungsten	4 A, 240 VAC	20 A, 240 VAC
		Motor	2.5 FLA, 15 LRA, 240 VAC	10 FLA, 60 LRA, 240 VAC
G3NA-225B		General use/Tungsten	4 A, 240 VAC	25 A, 240 VAC
		Motor	2.5 FLA, 15 LRA, 240 VAC	12 FLA, 72 LRA, 240 VAC
G3NA-240B		General use/Tungsten	6 A, 240 VAC	40 A, 240 VAC
		Motor	5 FLA, 30 LRA, 240 VAC	20 FLA, 120 LRA, 240 VAC
G3NA-250B-UTU		General use/Tungsten	6 A, 240 VAC	50 A, 240 VAC
		Motor	5 FLA, 30 LRA, 240 VAC	20 FLA, 120 LRA, 240 VAC
G3NA-275B-UTU-2		General use/Tungsten	7 A, 240 VAC	75 A, 240 VAC
		Motor	6 FLA, 36 LRA, 240 VAC	25 FLA, 150 LRA, 240 VAC
G3NA-290B-UTU-2		General use/Tungsten	7 A, 240 VAC	90 A, 240 VAC (General use only)
		Motor	6 FLA, 36 LRA, 240 VAC	25 FLA, 150 LRA, 240 VAC
G3NA-410B		General use/Tungsten	4 A, 480 VAC	10 A, 480 VAC
		Motor	2.5 FLA, 15 LRA, 480 VAC	5 FLA, 30 LRA, 480 VAC
G3NA-420B	General use/Tungsten	4 A, 480 VAC	20 A, 480 VAC	
	Motor	2.5 FLA, 15 LRA, 480 VAC	10 FLA, 60 LRA, 480 VAC	
G3NA-425B-2	General use/Tungsten	4 A, 480 VAC	25 A, 480 VAC	
	Motor	2.5 FLA, 15 LRA, 480 VAC	10 FLA, 60 LRA, 480 VAC	
G3NA-440B-2	General use/Tungsten	6 A, 480 VAC	25 A, 480 VAC	
	Motor	5 FLA, 30 LRA, 480 VAC	12 FLA, 72 LRA, 480 VAC	
G3NA-450B-UTU-2	General use/Tungsten	6 A, 480 VAC	50 A, 480 VAC	
	Motor	5 FLA, 30 LRA, 480 VAC	15 FLA, 90 LRA, 480 VAC	
G3NA-475B-UTU-2	General use/Tungsten	7 A, 480 VAC	75 A, 480 VAC	
	Motor	6 FLA, 36 LRA, 480 VAC	25 FLA, 150 LRA, 480 VAC	
G3NA-490B-UTU-2	General use/Tungsten	7 A, 480 VAC	90 A, 480 VAC (General use only)	
	Motor	6 FLA, 36 LRA, 480 VAC	25 FLA, 150 LRA, 480 VAC	
G3NA-610B	General use/Tungsten	4 A, 600 VAC	10 A, 600 VAC	
	Motor	2 FLA, 12 LRA, 600 VAC	4 FLA, 24 LRA, 600 VAC	
G3NA-625B	General use/Tungsten	4 A, 600 VAC	25 A, 600 VAC	
	Motor	2 FLA, 12 LRA, 600 VAC	10 FLA, 60 LRA, 600 VAC	
G3NA-650B	General use/Tungsten	6 A, 600 VAC	25 A, 600 VAC	
	Motor	3 FLA, 18 LRA, 600 VAC	15 FLA, 90 LRA, 600 VAC	
G3NA-D210B	General use/Tungsten	4 A, 200 VDC	10 A, 200 VDC	
	Motor	—	—	

- Note:**
1. When used with the proper OMRON heat sink part number or an appropriately dimensioned equivalent.
 2. The rated values approved by each of the safety standards (e.g., UL, CSA, and TUV) may be different from the performance characteristics individually defined in this catalog.
 3. In the interest of product improvement, specifications are subject to change.

Safety Precautions

Refer to *Safety Precautions for All Solid State Relays*.

! CAUTION

Touching the charged section may occasionally cause minor electric shock. Do not touch the G3NA terminal section (the charged section) when the power supply is ON. Be sure to attach the cover before use.



! CAUTION

The G3NA and heat sink will be hot and may occasionally cause minor burns. Do not touch the G3NA or the heat sink either while the power supply is ON, or immediately after the power is turned OFF.



! CAUTION

The internal snubber circuit is charged and may occasionally cause minor electric shock. Do not touch the G3NA's main circuit terminals immediately after the power is turned OFF.



! CAUTION

Be sure to conduct wiring with the power supply turned OFF, and always attach the terminal cover after completing wiring. Touching the terminals when they are charged may occasionally result in minor electric shock.



! CAUTION

Do not apply a short-circuit to the load side of the G3NA. The G3NA may rupture. To protect against short-circuit accidents, install a protective device, such as a quick-burning fuse, on the power supply line.



■ Precautions for Safe Use

Although OMRON continuously strives to improve the quality and reliability of our relays, the G3NA contains semiconductors, which are generally prone to occasional malfunction and failure. Maintaining safety is particularly difficult if a relay is used outside of its ratings. Always use the G3NA within the rated values. When using the G3NA, always design the system to ensure safety and prevent human accidents, fires, and social damage even in the event of G3NA failure, including system redundancy, measures to prevent fires from spreading, and designs to prevent malfunction.

- G3NA malfunction or fire damage may occasionally occur. Do not apply excessive voltage or current to the G3NA terminals.
- Heat Dissipation
 - Do not obstruct the airflow to the G3NA or heat sink. Heat generated from an G3NA error may occasionally cause the output element to short, or cause fire damage.
 - Be sure to prevent the ambient temperature from rising due to the heat radiation of the G3NA. If the G3NA is mounted inside a panel, install a fan so that the interior of the panel is fully ventilated.
 - Mount the G3NA in the specified orientation. If the G3NA is mounted in any other orientation, abnormal heat generation may cause output elements to short or may cause burning.
 - Do not use the G3NA if the heat sink fins are bent, e.g., as the result of dropping the G3NA. Heat dissipation characteristics will be reduced, possibly causing G3NA failure.
 - Apply a thin layer of Momentive Performance Materials's YG6260 or Shin-Etsu Chemical's G747, or a similar product to the heat sink before mounting
 - If a material with high thermal resistance, such as wood, is used, heat generated by the G3NA may occasionally cause fire or burning. When installing the G3NA directly into a control panel so that the panel can be used as a heat sink, use a panel material with low thermal resistance, such as aluminum or steel.
 - Use the specified heat sink or one with equivalent or better characteristics.

- Wire the G3NA and tighten screws correctly, observing the following precautions
 - Heat generated by a terminal error may occasionally result in fire damage. Do not operate if the screws on the output terminal are loose.
 - Abnormal heat generated by wires may occasionally result in fire damage. Use wires suitable for the load current.
 - Abnormal heat generated by terminals may occasionally result in fire damage. Do not operate if the screws on the output terminal are loose.

Tightening Torque

Screw size	Tightening torque
M4	1.2 N·m
M5	2.0 N·m

- Abnormal heat generated by terminals may occasionally result in fire damage. When tightening terminal screws, be sure that no non-conductive foreign matter is caught in screw.
 - For GN3A Relays of 40 A or higher, use crimp terminals of an appropriate size for the wire diameter for M5 terminals.
 - Do not use any wires with damaged sheaths. These may cause electric shock or leakage.
 - Do not place wiring in the same conduit or duct as high-voltage lines. Induction may cause malfunction or damage.
 - Use wires of an appropriate length, otherwise malfunction and damage may result due to induction.
 - Mount the DIN Track securely. Otherwise, the DIN Track may fall.
 - Be sure that the G3NA clicks into place when mounting it to DIN Track. The G3NA may fall if it is not mounted correctly.
 - Do not mount the G3NA when your hands are oily or dirty, e.g., with metal powder. These may cause G3NA failure.
 - Tighten the G3NA screws securely.
Tightening torque: 0.78 to 0.98 N·m
 - Tighten the heat sink screws securely.
Tightening torque: 0.98 to 1.47 N·m
- Preventing Overheating
 - When using the High-capacity Heat Sink (Y92B-P250NF), always use a thermostat or other method to protect from overheating in the event that the fan stops.
 - Do Not Touch Fan Blades
 - When the fan is operating, do not touch the fan blades with any part of your body or allow foreign matter to come into contact with the blades. Always attach the enclosed finger guard when using the G3NA.
 - Operating Conditions
 - Only use the G3NA with loads that are within the rated values. Using the G3NA with loads outside the rated values may result in malfunction, damage, or burning.
 - Use a power supply within the rated frequency range. Using a power supply outside the rated frequency range may result in malfunction, damage, or burning.
 - Do not transport the G3NA under the following conditions. Failure or malfunction may occur.
 - Conditions under which the G3NA will be exposed to water
 - High temperatures or high humidity
 - Without proper packing

Safety Precautions

Operating and Storage Locations

Do not use or store the G3NA in the following locations. Doing so may result in damage, malfunction, or deterioration of performance characteristics.

- Do not use or store in locations subject to direct sunlight.
- Do not use in locations subject to ambient temperatures outside the range -20 to 60°C.
- Do not use in locations subject to relative humidity outside the range 45% to 85% or locations subject to condensation as the result of severe changes in temperature.
- Do not store in locations subject to ambient temperatures outside the range -30 to 70°C.
- Do not use or store in locations subject to corrosive or flammable gases.
- Do not use or store in locations subject to dust (especially iron dust) or salts.
- Do not use or store in locations subject to shock or vibration.
- Do not use or store in locations subject to exposure to water, oil, or chemicals.
- Do not use or store in locations subject to high temperatures or high humidity.
- Do not use or store in locations subject to salt damage.
- Do not use or store in locations subject to rain or water drops.

Precautions for Correct Use

Please observe the following precautions to prevent failure to operate, malfunction, or undesirable effect on product performance.

Before Actual Operation

1. The G3NA in operation may cause an unexpected accident. Therefore it is necessary to test the G3NA under the variety of conditions that are possible. As for the characteristics of the G3NA, it is necessary to consider differences in characteristics between individual SSRs.
2. Unless otherwise specified, the ratings in this catalog are tested values in a temperature range between 15°C and 30°C, a relative humidity range between 25% and 85%, and an atmospheric pressure range between 88 and 106 kPa (standard test conditions according to JIS C5442). It will be necessary to provide the above conditions as well as the load conditions if the user wants to confirm the ratings of specific G3NAs.

Mounting Method

Note: The same method in case not use heatsink.

SSR Mounting Pitch (Panel Mounting)

The correct mounting direction is vertical as below figure.

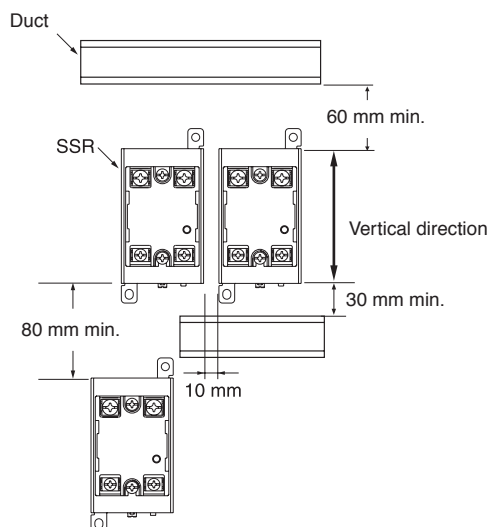

Relationship between SSRs and Duct Height

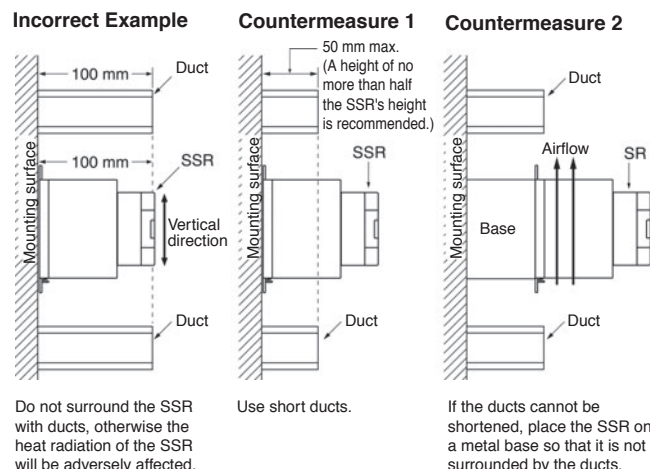

Ventilation Outside the Control Panel

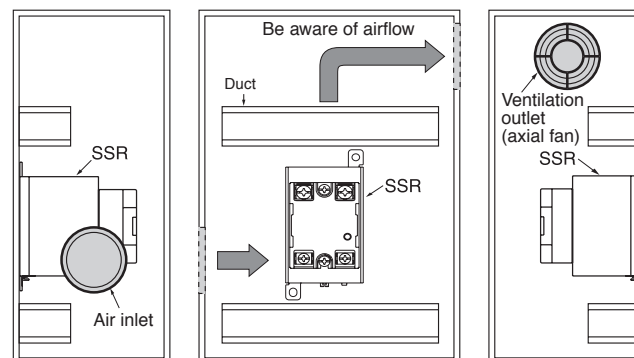

If the air inlet or air outlet has a filter, clean the filter regularly to prevent it from clogging to ensure an efficient flow of air.

Do not locate any objects around the air inlet or air outlet, otherwise the objects may obstruct the proper ventilation of the control panel.

A heat exchanger, if used, should be located in front of the SSRs to ensure the efficiency of the heat exchanger.

- Please reduce the ambient temperature of SSRs. The rated load current of an SSR is measured at an ambient temperature of 40°C.
- An SSR uses a semiconductor in the output element. This causes the temperature inside the control panel to increase due to heating resulting from the passage of electrical current through the load. To restrict heating, attach a fan to the ventilation outlet or air inlet of the control panel to ventilate the panel. This will reduce the ambient temperature of the SSRs and thus increase reliability. (Generally, each 10 °C reduction in temperature will double the expected life.)

Load current (A)	5 A	10 A	20 A	40 A	75 A	90 A
Required number of fans per SSR	0.08	0.16	0.31	0.62	1.2	1.44

Example: For 10 SSRs with load currents of 10 A,
 $0.16 \times 10 = 1.6$
 Thus, 2 fans would be required.

Size of fans: 92 mm², Air volume: 0.7 m³/min,
 Ambient temperature of control panel: 30 °C

If there are other instruments that generate heat in the control panel other than SSRs, additional ventilation will be required.

Safety Precautions

Calculating Heat Sink Area

An SSR with an external heat sink can be directly mounted to control panels under the following conditions.

- If the heat sink is made of steel used for standard panels, do not apply a current as high as or higher than 10 A, because the heat conductivity of steel is less than that of aluminum. Heat conductivity (in units of $W \cdot m \cdot ^\circ C$) varies with the material as described below.

Steel: 20 to 50

Aluminum: 150 to 220

The use of an aluminum-made heat sink is recommended if the SSR is directly mounted to control panels. Refer to the data sheet of the SSR for the required heat sink area.

- Apply heat-radiation silicon grease (e.g., the YG6260 from Toshiba or the G746 from Shin-Etsu) or a heat conductive sheet between the SSR and heat sink. There will be a space between the SSR and heat sink attached to the SSR. Therefore, the generated heat of the SSR cannot be radiated properly without the grease. As a result, the SSR may be overheated and damaged or deteriorated.

The heat dissipation capacity of a heat conduction sheet is generally inferior to that of silicon grease. If a heat conduction sheet is used, reduce the load current by approximately 10% from the *Load Current vs. Ambient Temperature Characteristics* graph.

Control Panel Heat Radiation Designing

Control equipment using semiconductors will generate heat, regardless of whether SSRs are used or not. The failure rate of semiconductors greatly increases when the ambient temperature rises. It is said that the failure rate of semiconductors will be doubled when the temperature rises $10^\circ C$ (Arrhenius model).

Therefore, it is absolutely necessary to suppress the interior temperature rise of the control panel in order to ensure the long, reliable operation of the control equipment.

Heat-radiating devices in a wide variety exists in the control panel. As a matter of course, it is necessary to consider the total temperature rise as well as local temperature rise of the control panel. The following description provides information on the total heat radiation designing of the control panel.

As shown below, the heat conductivity Q will be obtained from the following formula, provided that t_h and t_c are the temperature of the hot fluid and that of the cool fluid separated by the fixed wall.

$$Q = k (t_h - t_c) A$$

Where, k is an overall heat transfer coefficient ($W/m^2 \cdot ^\circ C$). This formula is called a formula of overall heat transfer.

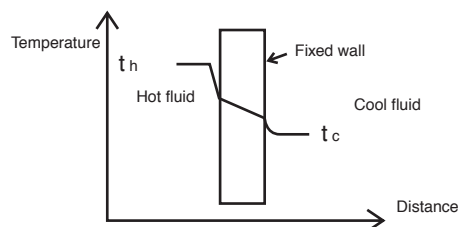

When this formula is applicable to the heat conductivity of the control panel under the following conditions, the heat conductivity Q will be obtained as shown below.

Average rate of overall heat transfer of control panel: k ($W/m^2 \cdot ^\circ C$)

Internal temperature of control panel: T_h ($^\circ C$)

Ambient temperature: T_c ($^\circ C$)

Surface area of control panel: S (m^2)

$$Q = k \times (T_h - T_c) \times S$$

The required cooling capacity is obtained from the following formula under the following conditions.

Desired internal temperature of control panel: T_h ($^\circ C$)

Total internal heat radiation of control panel: P_1 (W)

Required cooling capacity: P_2 (W)

$$P_2 = P_1 - k \times (T_h - T_c) \times S$$

The overall heat transfer coefficient k of a standard fixed wall in a place with natural air ventilation will be 4 to 12 ($W/m^2 \cdot ^\circ C$). In the case of a standard control panel with no cooling fan, it is an empirically known fact that a coefficient of 4 to 6 ($W/m^2 \cdot ^\circ C$) is practically applicable. Based on this, the required cooling capacity of the control panel is obtained as shown below.

Example

- Desired internal temperature of control panel: $40^\circ C$

- Ambient temperature: $30^\circ C$

- Control panel size $2.5 \times 2 \times 0.5$ m ($W \times H \times D$)
Self-sustained control panel (with the bottom area excluded from the calculation of the surface area)

- SSR: 20 G3PA-240B Units in continuous operation at 30 A.

- Total heat radiation of all control devices except SSRs: 500 W

Total heat radiation of control panel: P_1

$$P_1 = \text{Output-ON voltage drop } 1.6 \text{ V} \times \text{Load current } 30 \text{ A} \times 20 \text{ SSRs} + \text{Total heat radiation of all control devices except SSRs} = 960 \text{ W} + 500 \text{ W} = 1460 \text{ W}$$

Heat radiation from control panel: Q_2

$$Q_2 = \text{Rate of overall heat transfer } 5 \times (40^\circ C - 30^\circ C) \times (2.5 \text{ m} \times 2 \text{ m} \times 2 + 0.5 \text{ m} \times 2 \text{ m} \times 2 + 2.5 \text{ m} \times 0.5 \text{ m}) = 662.5 \text{ W}$$

Therefore, the required cooling capacity P_2 will be obtained from the following formula.

$$P_2 = 1,460 - 663 = 797 \text{ W}$$

Therefore, heat radiation from the surface of the control panel is insufficient. More than a heat quantity of 797 W needs to be radiated outside the control panel.

Usually, a ventilation fan with a required capacity will be installed. If the fan is not sufficient, an air conditioner for the control panel will be installed. The air conditioner is ideal for the long-time operation of the control panel because it will effectively dehumidify the interior of the control panel and eliminate dust gathering in the control panel.

Axial-flow fan: OMRON's R87B, R87F, and R87T Series

Air conditioner for control panel: Apiste's ENC Series

Safety Precautions

High-capacity Heat Sink (Y92B-P250NF)

DIN-track Mounting

- Assembled DIN Tracks are heavy. Mount the DIN Tracks securely. Be sure that the Heat Sink is securely locked to the DIN Track.
- Attach End Plates (PFP-M, order separately) to both ends of the Units on the DIN Track to hold them in place.
- To mount a Heat Sink to a DIN Track, press down at the point indicated by arrow 1 in the diagram and then press in the Heat Sink at the point indicated by arrow 2.

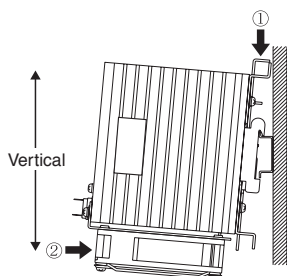

Applicable DIN Track

Mounting is possible on TE35-15Fe (IEC 60715) DIN tracks. DIN tracks from the following manufacturers can be used.

Manufacturer	Thickness: 1.5 mm	Thickness: 2.3 mm
Schneider	AM1-DE2000	---
WAGO	210-114 or 210-197	210-118
PHOENIX	N35/15	N35/15/15-2.3

Direct Mounting

- Prepare mounting holes as shown in the diagram. Tightening torque: 0.98 to 1.47 N·m

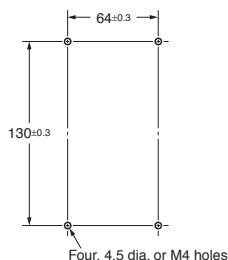

- When mounting a Heat Sink directly, first remove the Fan Unit, then mount the Heat Sink by itself before attaching the Fan Unit again. (Remove the two screws shown in the following diagram.)

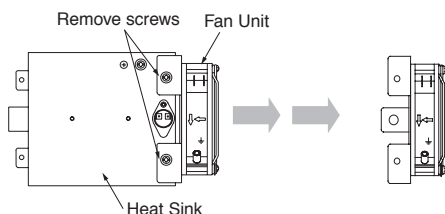

- First, temporarily mount the Heat Sink with the bottom two screws and then attach the top two screws with the mounting bracket sandwiched between the Heat Sink and mounting surface. Finally, tighten all four screws.

Ratings and Characteristics of High-capacity Heat Sink (Y92B-P250NF)

Fan Ratings

Rated voltage	200 V
Operating voltage	85% to 110% of rated voltage
Frequency	50/60 Hz
Rated current (See note.)	0.061 A at 50 Hz 0.052 A at 60 Hz
Rated speed (See note.)	2,600 r/min at 50 Hz 3,050 r/min at 60 Hz

Note: Average values.

Thermostat Ratings

Operating temperature	Approx. 90°C
Contact ratings	8 A at 250 VAC, resistive load 5 A at 30 VDC, resistive load

Fan Characteristics

Motor type	Single-phase shading coil induction motor (2-pole, open type)
Terminal type	Terminals
Insulation class	IEC class B (130°C) UL class A (105°C) CSA class A (105°C)
Insulation resistance	100 MΩ min. (at 500 VDC) between all power supply connections and uncharged metal parts.
Insulation withstand voltage	2,000 VAC (1 minute) between all power supply connections and uncharged metal parts.
Ambient operating temperature	-30 to 70°C (no icing)
Ambient storage temperature	-40 to 85°C (no icing)
Ambient humidity	25 to 85%
Protection	Impedance protection
Materials	Frame : Die-cast aluminum Blades : Glass polycarbonate
Bearings	Ball bearings
Weight	Approx. 300 g
Compliant standards	PSE, EN/IEC 60335 (CE marking compliant)
Certified standards	UL/CSA (pending)

- Use a commercial power supply (50/60 Hz) for the Fan.
- Be sure to turn OFF the power supply and wait for the blades to stop before inspecting the Fan.
- High-precision ball bearings are used in the fan and these may be damaged if the Fan is dropped or otherwise subjected to shock. The life and characteristics of the Fan will be reduced if the bearings are damaged. Do not subject the Fan to shock.
- The life of the Fan depends on the ambient temperature. As a guideline, the Fan life is 40,000 hours for continuous usage at 40°C.
- Be sure there are no objects near the air vents that would restrict air flow and no loose objects, such as electrical lines.
- The Fan is an OMRON R87F-A4A-93HP (200 VAC) Fan. Use the same model of Fan for replacement.
- The recommended tightening torque for the Fan is 0.44 N·m.
- Terminals equivalent to Faston #110 are used for the Fan power supply terminals.
- Refer to the following table for the OMRON Fan power supply plug cables (order separately).

Cable length	UL certified	Complies with Electrical Appliance and Material Safety Law (Japan)
1 m	R87F-PC	R87F-PCJT
2 m	R87F-PC-20	R87F-PCJT-20

- Connect the ground screw hole on the fan to PE.

Safety Precautions

Preventing Overheating with a High-capacity Heat Sink (Y92B-P250NF)

- When the High-capacity Heat Sink is used, high-capacity switching at 75 A or 90 A requires forced cooling with a fan. Connect the Fan to a power supply according to its ratings specifications.
- If the Fan stops due to a power supply error, due to foreign matter in the power supply connection, or due to aging, the Heat Sink will heat to high temperatures, possibly resulting in failure of the SSR or adverse affects on other devices. Implement an overheating prevention measure, such as turning OFF the load current, if the Heat Sink overheats.
- A thermostat is provided to detect overheating. The thermostat uses a NC contact, i.e., the circuit will be opened for overheating. This thermostat can be used to stop the operation of the SSR. Implement an overheating prevention measure by using this signal to output an alarm or perform another response applicable to the system. Also, confirm that there is no problem with the overall system.
- Do not connect the thermostat directly to the load power supply. Connect it to a contactor or other shutoff device connected above the SSR.
- Terminals equivalent to Faston #187 are used for the thermostat terminals.
- Do not place heat-dissipating silicon grease on the thermostat.
- Do not solder the thermostat terminals.
- The following diagram shows a protective circuit example.

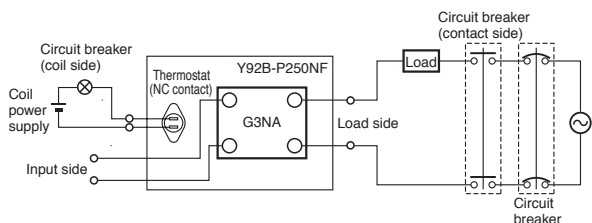

Ventilating a High-capacity Heat Sink (Y92B-P250NF)

- Refer to *Ventilation Outside the Control Panel*.

Operating Conditions

- Do not apply currents exceeding the rated current otherwise, the temperature of the G3NA may rise excessively.
- As protection against accidents due to short-circuiting, be sure to install protective devices, such as fuses and no-fuse breakers, on the power supply side.
- Do not apply overvoltages to the input circuit or output circuit. Failure or burning may result.
- Do not drop the G3NA or otherwise subject it to abnormal shock. Malfunction or failure may result.
- Keep the cooling system running continuously during the ON/OFF operation of the SSR. This is to allow residual heat to dissipate while the SSR is OFF. (load current 75 A, 90 A models)
- The Y92B-P250NF is a Class 1 device. If compliance with EU standards is required, ground the Y92B-P250NF.
- Use the ground terminal on the Heat Sink. Screw size: M5 Tightening torque: 2 N·m Do not use the ground terminal on the fan.

EMC Directive Compliance (For -UTU type)

EMC directives can be complied with under the following conditions.

1. AC-switching models

- A capacitor must be connected to the input power supply.
- A capacitor, varistor and toroidal core must be connected to the load power supply.
- The input cable must be less than 3 m.

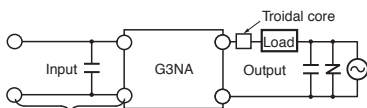

Recommended Capacitor : 0.05 μ F, 500 VAC (Load)
0.1 μ F, 250 VAC (Input)
Recommended Varistor : 470 V, 1750 A
Recommended Troidal core : NEC/TOKIN:ESD-R-25B or equivalent

2. DC-switching models

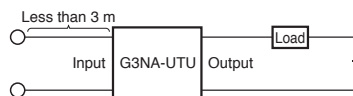

- The input cable must be less than 3 m.

Loss Time

The loss time will increase when the G3NA is used at a low applied voltage or current. Be sure that this does not cause any problems.

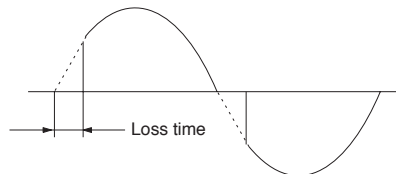

Using DC Loads

For a DC or L load, a diode should be connected in parallel the load to absorb the counter electromotive force of the load.

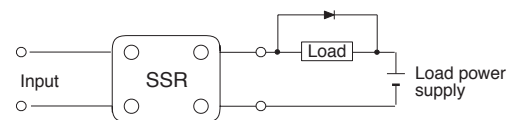

Fuses

Connect a quick-break fuse in series with the load as a short-circuit protection measure. Use one of the fuses in the following table or one with equivalent or better characteristics.

Recommended Fuses

G3NA rated load current	Fuse model	Manufacturer	Applicable SSR
5 A	60LFF5	HINODE ELECTRIC CO.,LTD.	G3NA-205B
8 A	60LFF8		G3NA-210B
10 A	60LFF10		G3NA-220B
15 A	60LFF15		
20 A	60LFF20 50SHA20		G3NA-240B
25 A	60PFF25 50SHA25		
30 A	60PFF30 50SHA30		
40 A	50SHA40		
45 A	50SHA45		G3NA-275B-UTU(-2)
50 A	50SHA50		
75 A	50SHA75	G3NA-290B-UTU(-2)	
80 A	50SHA80		
100 A	50SHB100		

Reverse Connection

The output terminal side of the G3NA-D210B is connected to a built-in diode to protect the SSR from damage that may result from reverse connection. The SSR, however, cannot withstand one minute or more if the wires are connected in reverse. Therefore, pay the utmost attention not to make polarity mistakes on the load side.

Installation and Mounting

- Mount the G3NA securely with screws. Keep the screws tightened to a torque of 0.78 to 0.98 N·m.
- Mount the Heat Sink securely with screws. Keep the screws tightened to a torque of 0.98 to 1.47 N·m.

Safety Precautions

■ Precautions on Operating and Storage Environments

1. Operating Ambient Temperature

The rated value for the ambient operating temperature of the G3NA is for when there is no heat build-up. For this reason, under conditions where heat dissipation is not good due to poor ventilation, and where heat may build up easily, the actual temperature of the G3NA may exceed the rated value resulting in malfunction or burning.

When using the G3NA, design the system to allow heat dissipation sufficient to stay below the *Load Current vs. Ambient Temperature* characteristic curve. Note also that the ambient temperature of the G3NA may increase as a result of environmental conditions (e.g., climate or air-conditioning) and operating conditions (e.g., mounting in an airtight panel).

2. Transportation

When transporting the G3NA, observe the following points. Not doing so may result in damage, malfunction, or deterioration of performance characteristics.

- Do not drop the G3NA or subject it to severe vibration or shock.
- Do not transport the G3NA if it is wet.
- Do not transport the G3NA under high temperatures or humidity.
- Do not transport the G3NA without packing it properly.

3. Vibration and Shock

Do not subject the G3NA to excessive vibration or shock. Otherwise the G3NA may malfunction and internal components may be deformed or damaged, resulting in failure of the G3NA to operate.

To prevent the G3NA from abnormal vibration, do not install the G3NA in locations or by means that will subject it to vibration from other devices, such as motors.

4. Solvents

Do not allow the G3NA or the resin portion of the Fan's thermostat to come in contact with solvents, such as thinners or gasoline. Doing so will dissolve the markings on the G3NA.

5. Oil

Do not allow the G3NA terminal cover to come in contact with oil. Doing so will cause the cover to crack and become cloudy.

■ Operation

1. Leakage Current

A leakage current flows through a snubber circuit in the G3NA even when there is no power input. Therefore, always turn OFF the power to the input or load and check that it is safe before replacing or wiring the G3NA.

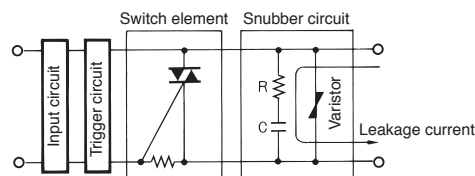

2. Screw Tightening Torque

Tighten the G3NA terminal screws properly. If the screws are not tight, the G3NA will be damaged by heat generated when the power is ON. Perform wiring using the specified tightening torque.

3. Handling Relays

Do not mount the G3NA when your hands are oily or dirty, e.g., with metal powder. These may cause G3NA failure.

4. Do Not Drop

Be careful not to drop a Relay or Heat Sink onto any part of your body while working. Injury may result. This is particularly true for the High-capacity Heat Sink (Y92B-P250NF), which weighs 2.5 kg.

ALL DIMENSIONS SHOWN ARE IN MILLIMETERS.

To convert millimeters into inches, multiply by 0.03937. To convert grams into ounces, multiply by 0.03527.

In the interest of product improvement, specifications are subject to change without notice.

Read and Understand This Catalog

Please read and understand this catalog before purchasing the products. Please consult your OMRON representative if you have any questions or comments.

Warranty and Limitations of Liability

WARRANTY

OMRON's exclusive warranty is that the products are free from defects in materials and workmanship for a period of one year (or other period if specified) from date of sale by OMRON.

OMRON MAKES NO WARRANTY OR REPRESENTATION, EXPRESS OR IMPLIED, REGARDING NON-INFRINGEMENT, MERCHANTABILITY, OR FITNESS FOR PARTICULAR PURPOSE OF THE PRODUCTS. ANY BUYER OR USER ACKNOWLEDGES THAT THE BUYER OR USER ALONE HAS DETERMINED THAT THE PRODUCTS WILL SUITABLY MEET THE REQUIREMENTS OF THEIR INTENDED USE. OMRON DISCLAIMS ALL OTHER WARRANTIES, EXPRESS OR IMPLIED.

LIMITATIONS OF LIABILITY

OMRON SHALL NOT BE RESPONSIBLE FOR SPECIAL, INDIRECT, OR CONSEQUENTIAL DAMAGES, LOSS OF PROFITS OR COMMERCIAL LOSS IN ANY WAY CONNECTED WITH THE PRODUCTS, WHETHER SUCH CLAIM IS BASED ON CONTRACT, WARRANTY, NEGLIGENCE, OR STRICT LIABILITY.

In no event shall the responsibility of OMRON for any act exceed the individual price of the product on which liability is asserted.

IN NO EVENT SHALL OMRON BE RESPONSIBLE FOR WARRANTY, REPAIR, OR OTHER CLAIMS REGARDING THE PRODUCTS UNLESS OMRON'S ANALYSIS CONFIRMS THAT THE PRODUCTS WERE PROPERLY HANDLED, STORED, INSTALLED, AND MAINTAINED AND NOT SUBJECT TO CONTAMINATION, ABUSE, MISUSE, OR INAPPROPRIATE MODIFICATION OR REPAIR.

Application Considerations

SUITABILITY FOR USE

OMRON shall not be responsible for conformity with any standards, codes, or regulations that apply to the combination of products in the customer's application or use of the products.

At the customer's request, OMRON will provide applicable third party certification documents identifying ratings and limitations of use that apply to the products. This information by itself is not sufficient for a complete determination of the suitability of the products in combination with the end product, machine, system, or other application or use.

The following are some examples of applications for which particular attention must be given. This is not intended to be an exhaustive list of all possible uses of the products, nor is it intended to imply that the uses listed may be suitable for the products:

Outdoor use, uses involving potential chemical contamination or electrical interference, or conditions or uses not described in this catalog.

Nuclear energy control systems, combustion systems, railroad systems, aviation systems, medical equipment, amusement machines, vehicles, safety equipment, and installations subject to separate industry or government regulations.

Systems, machines, and equipment that could present a risk to life or property.

Please know and observe all prohibitions of use applicable to the products.

NEVER USE THE PRODUCTS FOR AN APPLICATION INVOLVING SERIOUS RISK TO LIFE OR PROPERTY WITHOUT ENSURING THAT THE SYSTEM AS A WHOLE HAS BEEN DESIGNED TO ADDRESS THE RISKS, AND THAT THE OMRON PRODUCTS ARE PROPERLY RATED AND INSTALLED FOR THE INTENDED USE WITHIN THE OVERALL EQUIPMENT OR SYSTEM.

PROGRAMMABLE PRODUCTS

OMRON shall not be responsible for the user's programming of a programmable product, or any consequence thereof.

Disclaimers

CHANGE IN SPECIFICATIONS

Product specifications and accessories may be changed at any time based on improvements and other reasons.

It is our practice to change model numbers when published ratings or features are changed, or when significant construction changes are made. However, some specifications of the products may be changed without any notice. When in doubt, special model numbers may be assigned to fix or establish key specifications for your application on your request. Please consult with your OMRON representative at any time to confirm actual specifications of purchased products.

DIMENSIONS AND WEIGHTS

Dimensions and weights are nominal and are not to be used for manufacturing purposes, even when tolerances are shown.

PERFORMANCE DATA

Performance data given in this catalog is provided as a guide for the user in determining suitability and does not constitute a warranty. It may represent the result of OMRON's test conditions, and the users must correlate it to actual application requirements. Actual performance is subject to the OMRON Warranty and Limitations of Liability.

ERRORS AND OMISSIONS

The information in this document has been carefully checked and is believed to be accurate; however, no responsibility is assumed for clerical, typographical, or proofreading errors, or omissions.