



HMC423MS8 / 423MS8E

GaAs MMIC MIXER w/ INTEGRATED LO AMPLIFIER, 0.6 - 1.3 GHz

Typical Applications

The HMC423MS8 / HMC423MS8E is ideal for:

- Base Stations
- Portable Wireless
- CATV/DBS
- ISM

Features

- Integrated LO Amplifier w/ P_{diss} <50 mW
- Conversion Loss / Noise Figure: 8 dB
- Low LO Drive: 0 dBm
- Input IP₃: +15 dBm
- Single Positive Supply: 3V, 15 mA

Functional Diagram

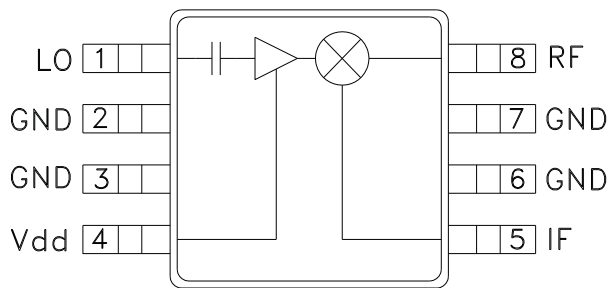

General Description

The HMC423MS8 & HMC423MS8E are double balanced mixer ICs with integrated LO amplifiers. This mixer can operate as an upconverter or downconverter between 0.6 GHz and 1.3 GHz. With the integrated LO amplifier, the mixer requires an LO drive level of only 0 dBm, and requires only 15mA from a single positive +3V rail. The mixer has 8 dB of conversion loss, an input P_{1dB} of +8 dBm and an input third order intercept point of +15 dBm at 1.3 GHz.

Electrical Specifications, T_A = +25° C

Parameter	IF = 100 MHz LO = 0 dBm, V _{dd} = 3V			Units
	Min.	Typ.	Max.	
Frequency Range, RF & LO	0.6 - 1.3			GHz
Frequency Range, IF	DC - 0.4			GHz
Conversion Loss		8	11	dB
Noise Figure (SSB)		8	11	dB
LO to RF Isolation	25	35		dB
LO to IF Isolation	15	25		dB
RF to IF Isolation	12	20		dB
IP ₃ (Input)	13	15		dBm
1 dB Compression (I _{dd})	6.5	8		dBm
Supply Current (I _{dd})		15		mA

* Unless otherwise noted, all measurements performed as downconverter, IF= 100 MHz.

For price, delivery, and to place orders, please contact Hittite Microwave Corporation:
 20 Alpha Road, Chelmsford, MA 01824 Phone: 978-250-3343 Fax: 978-250-3373
 Order On-line at www.hittite.com



Conversion Gain vs. Temperature @ LO = 0 dBm

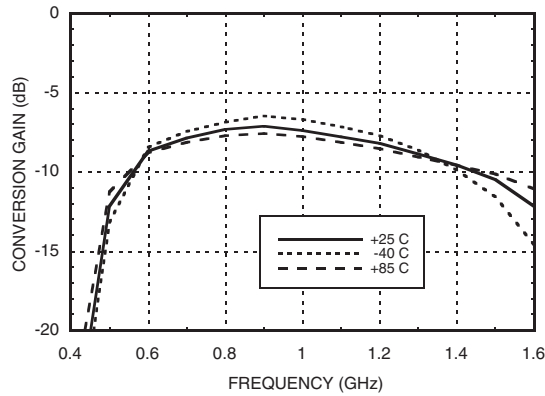

Isolation @ LO = 0 dBm

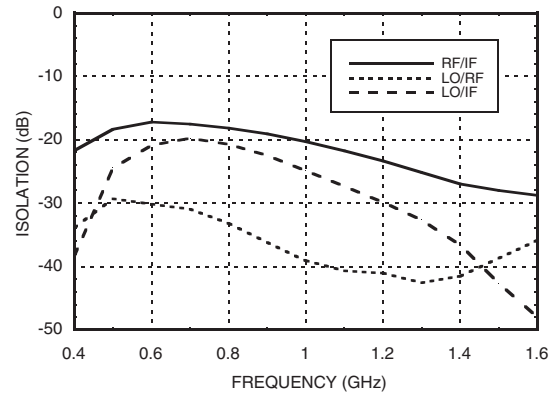

Conversion Gain vs. LO Drive

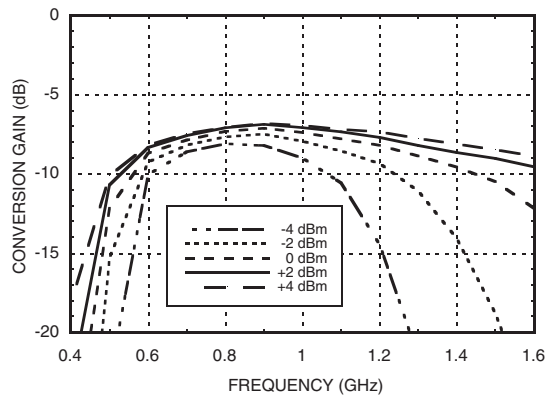

Return Loss @ LO = 0 dBm

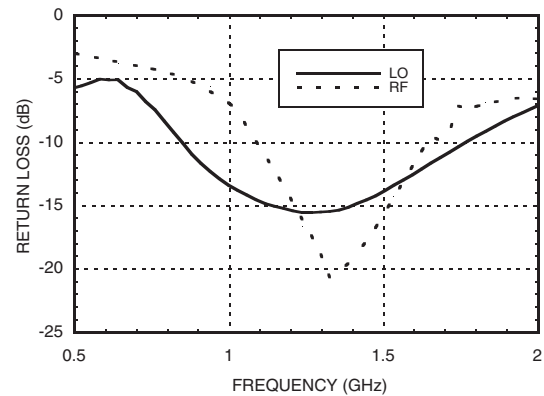

Conversion Gain vs. Vdd @ LO = 0 dBm

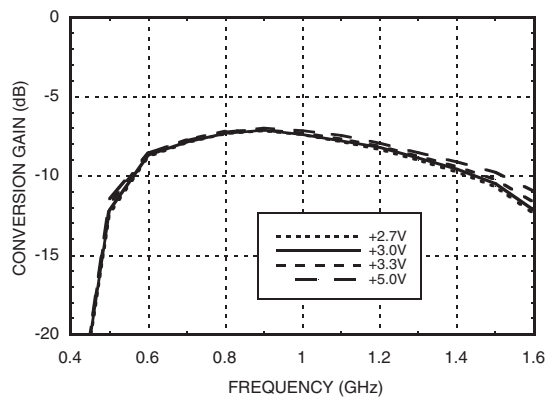

IF Bandwidth @ LO = 0 dBm

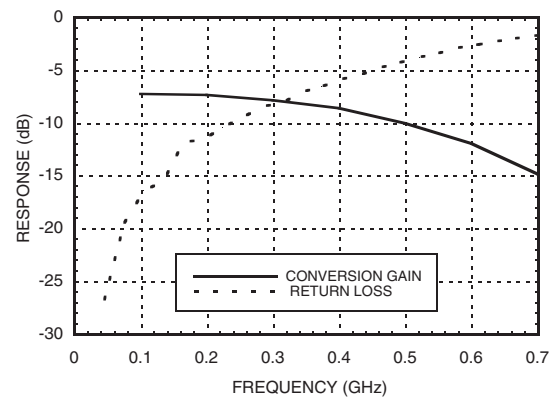



Upconverter Performance Conversion Gain @ LO = 0 dBm

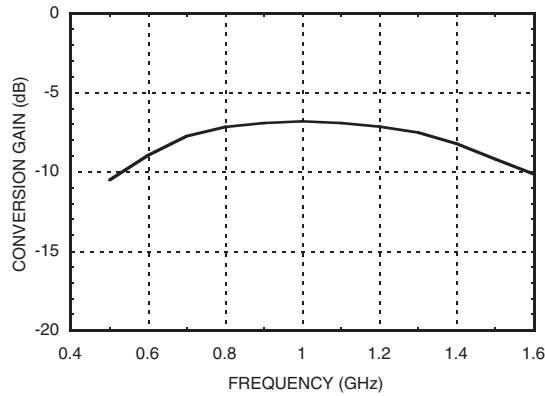

Input P1dB vs. Temperature @ LO = 0 dBm

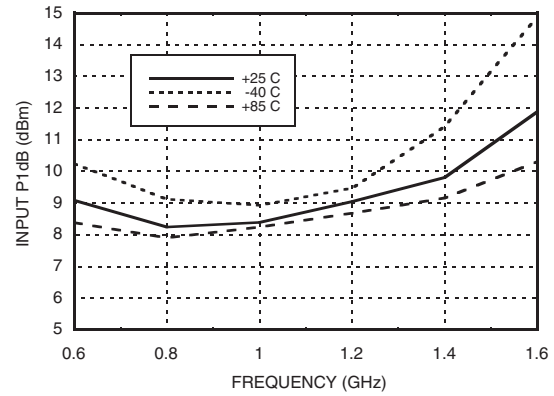

Input IP3 vs. LO Drive*

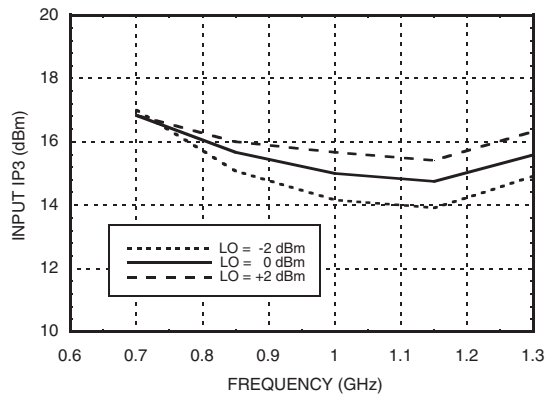

Input IP3 vs. Temperature @ LO = 0 dBm*

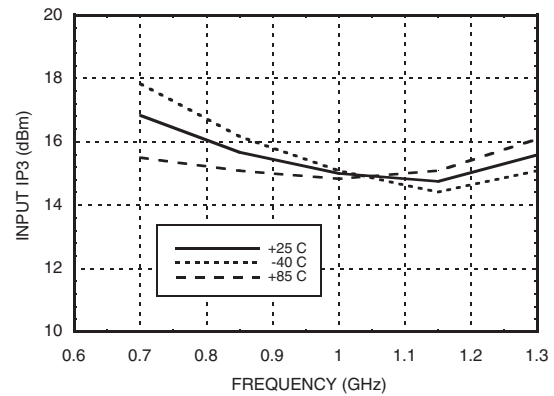

MxN Spurious @ IF Port

mRF	nLO				
	0	1	2	3	4
0	XX	5	25	27	26
1	12	0	31	45	57
2	70	61	70	49	78
3	>92	89	87	73	77
4	>92	>92	>92	>92	>92

RF = 1.0 GHz @ -10 dBm
LO = 0.9 GHz @ 0 dBm
All values in dBc relative to the IF.
Measured as downconverter.

Harmonics of LO

LO Freq. (GHz)	nLO Spur @ RF Port			
	1	2	3	4
0.7	30	15	42	40
0.85	34	16	50	42
1	38	19	48	52
1.15	40	22	54	58
1.3	42	26	44	59
1.45	39	31	50	60

LO = 0 dBm
All values in dBc below input LO level @ RF port.

* Two-tone input power = 0 dBm each tone, 1 MHz spacing.

Absolute Maximum Ratings

RF / IF Input (Vdd = +3V)	+13 dBm
LO Drive (Vdd = +3V)	+13 dBm
Vdd	+7 Vdc
IF DC Current	±18 mA
Channel Temperature (Tc)	150 °C
Continuous P _{diss} (T = 85°C) (Derate 4.8 mW/°C above 85 °C)	0.32 W
Storage Temperature	-65 to +150 °C
Operating Temperature	-40 to +85 °C



ELECTROSTATIC SENSITIVE DEVICE
OBSERVE HANDLING PRECAUTIONS

Outline Drawing

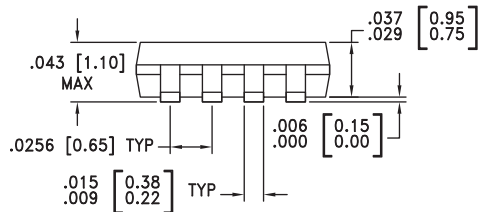
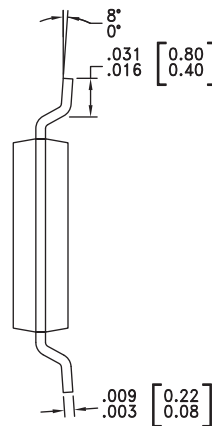
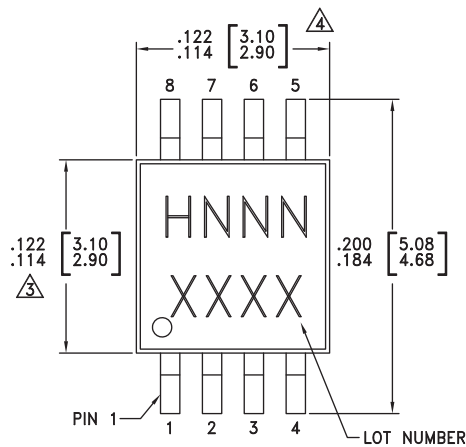

NOTES:

1. LEADFRAME MATERIAL: COPPER ALLOY
2. DIMENSIONS ARE IN INCHES [MILLIMETERS]
3. DIMENSION DOES NOT INCLUDE MOLDFLASH OF 0.15mm PER SIDE.
4. DIMENSION DOES NOT INCLUDE MOLDFLASH OF 0.25mm PER SIDE.
5. ALL GROUND LEADS MUST BE SOLDERED TO PCB RF GROUND.

Package Information

Part Number	Package Body Material	Lead Finish	MSL Rating	Package Marking ^[3]
HMC423MS8	Low Stress Injection Molded Plastic	Sn/Pb Solder	MSL1 ^[1]	H423 XXXX
HMC423MS8E	RoHS-compliant Low Stress Injection Molded Plastic	100% matte Sn	MSL1 ^[2]	H423 XXXX



[1] Max peak reflow temperature of 235 °C

[2] Max peak reflow temperature of 260 °C

[3] 4-Digit lot number XXXX

For price, delivery, and to place orders, please contact Hittite Microwave Corporation:
20 Alpha Road, Chelmsford, MA 01824 Phone: 978-250-3343 Fax: 978-250-3373
Order On-line at www.hittite.com

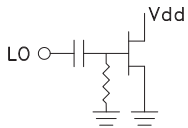
Pin Description

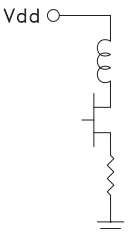
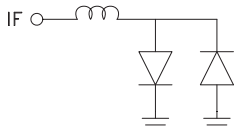
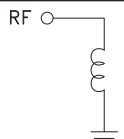
Pin Number	Function	Description	Interface Schematic
1	LO	This pin is AC coupled and matched to 50 Ohm from 0.6 - 1.3 GHz.	
2, 3, 6, 7	GND	Pins must connect to RF ground.	
4	Vdd	Power supply for the LO Amplifier. One external RF bypass capacitor (10,000 pF) is required.	
5	IF	This pin is DC coupled. For applications not requiring operation to DC, this port should be DC blocked externally using a series capacitor whose value has been chosen to pass the necessary IF frequency range. For operation to DC, this pin must not source/sink more than 18 mA of current or die non-function and possible die failure will result.	
8	RF	This pin is DC coupled and matched to 50 Ohm from 0.6 - 1.3 GHz	

Application Circuit

C1	10,000 pF
L1	4.7 nH

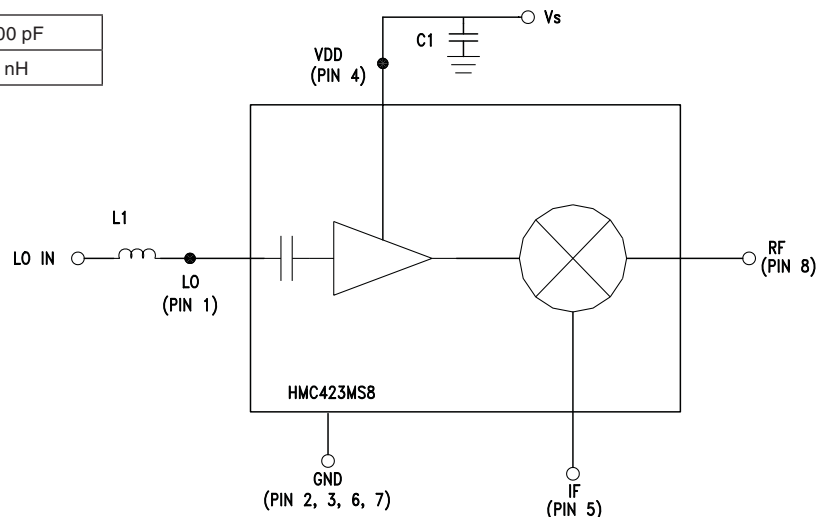

Evaluation PCB

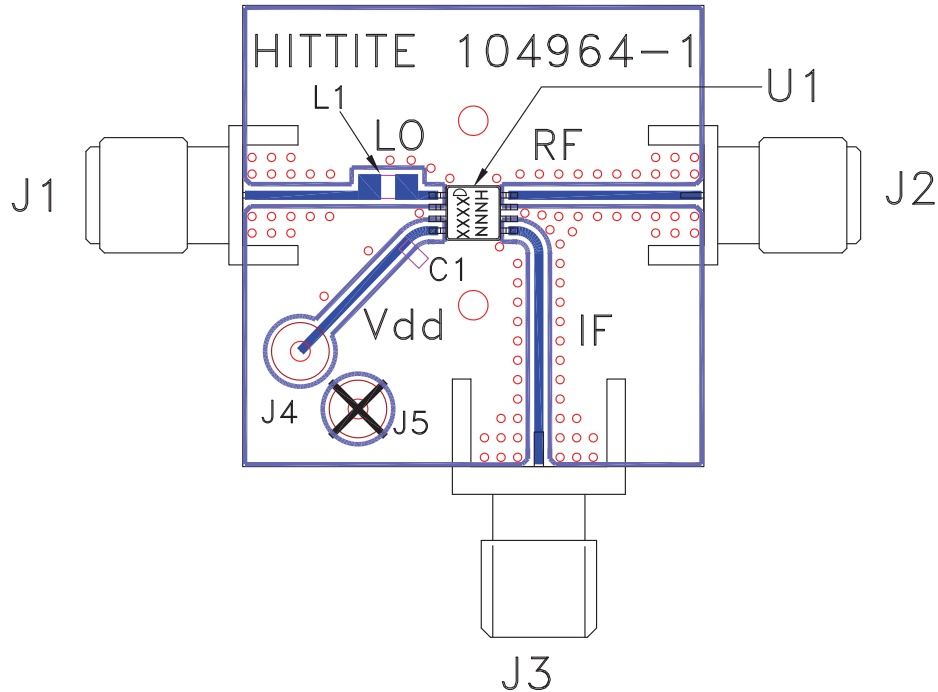

List of Materials for Evaluation PCB 105190 [1]

Item	Description
J1 - J3	PCB Mount SMA Connector, Johnson
J4, J5	DC Pin
C1	10k pF Chip Capacitor, 0603 Pkg.
L1	4.7 nH Inductor, 0805 Pkg.
U1	HMC423MS8 / HMC423MS8E Mixer
PCB [2]	104964 Evaluation Board, 1.00" x 1.00"

[1] Reference this number when ordering complete evaluation PCB

[2] Circuit Board Material: Rogers 4350

The circuit board used in the final application should use RF circuit design techniques. Signal lines should have 50 ohm impedance while the package ground leads should be connected directly to the ground plane similar to that shown. A sufficient number of via holes should be used to connect the top and bottom ground planes. The evaluation circuit board shown is available from Hittite upon request.