

DMM6500 6½-Digit Bench/System Digital Multimeter

Datasheet



KEITHLEY
A Tektronix Company

The DMM6500 is a modern bench/system DMM delivering more measurement functionality, best-in-class measurement insight, and a price that will not break your budget. The most recognizable feature of the DMM6500 is the large 5-inch (12.7 cm) capacitive touch screen display that makes it easy to observe, interact with, and explore measurements with “pinch and zoom” simplicity. Beyond its display technology, the DMM 6500 superior analog measurement performance delivers 25 PPM basic DCV accuracy for one year and 30 PPM for two years, potentially allowing you to extend your calibration cycles.

The DMM6500 is equipped with all the measurement functions you would expect in a bench multimeter, so there’s no need to buy additional measurement capabilities. Its 15 measurement functions, including capacitance, temperature (RTD, thermistor, and thermocouple), diode test with variable current sources, and up to 1 MS/sec digitizing are now included.

The digitizing function can be used for voltage or current and is especially useful in capturing transient anomalies or to help profile power events such as the operating states of today’s battery operated devices. Current and voltage can be digitized with a programmable 1 MS/sec 16-bit digitizer, making it possible to acquire waveforms without the need for a separate instrument.

Key Features

- 15 measurement functions including capacitance, temperature, and digitizing
- Expanded measurement ranges include 10 pA to 10 A and 1 mΩ to 100 MΩ
- Large 5-inch (12.7 cm) multi-touch capacitive touchscreen with graphical display
- Large internal memory; store up to 7 million readings
- Multiple language modes: SCPI, TSP® scripting, Keithley 2000 SCPI emulation, Keysight 34401A SCPI emulation
- Two-year specifications allow for longer calibration cycles
- Standard USB-TMC and LXI/Ethernet communication interfaces
- Optional user-installable communication interfaces including: GPIB, TSP-Link®, and RS-232
- Capture voltage or current transients with 1 MS/sec digitizer
- USB host port for storing readings, instrument configurations, and screen images
- Three-year warranty



Analyze complex waveforms with the touchscreen display.

Capture and Analyze Voltage or Current Transitions

Power analysis is becoming more important in today's electronic designs. Designers must now consider more efficient components and complex system design typically requiring multiple power states. The DMM6500 has the tools you need to help design and troubleshoot these complex systems. Eight different current ranges allow measurements from 10 amps down to 10 pico-amps, giving you the dynamic range to measure your power states. In addition, a built-in 1 MS/sec digitizing function can help capture transient events, allowing you to see and analyze transitions as they occur.

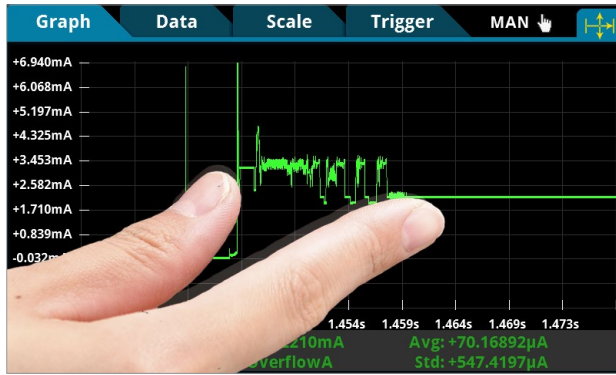

Pinch and zoom simplicity for in-depth waveform analysis.

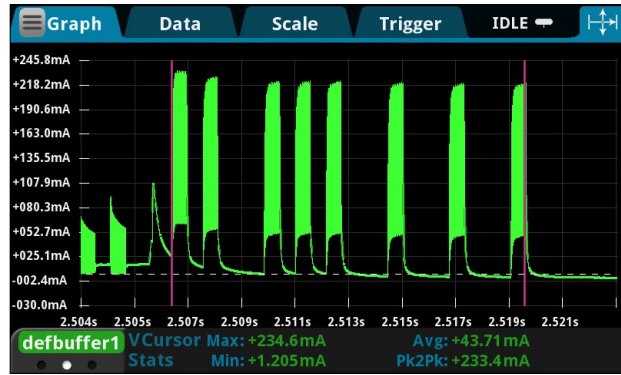

Visualize and analyze waveforms using adjustable cursors and statistics.

DMM6500 Measurement Capabilities



DMM6500 15 measurement functions and ranges.

DMM6500 Touchscreen Display Front Panel

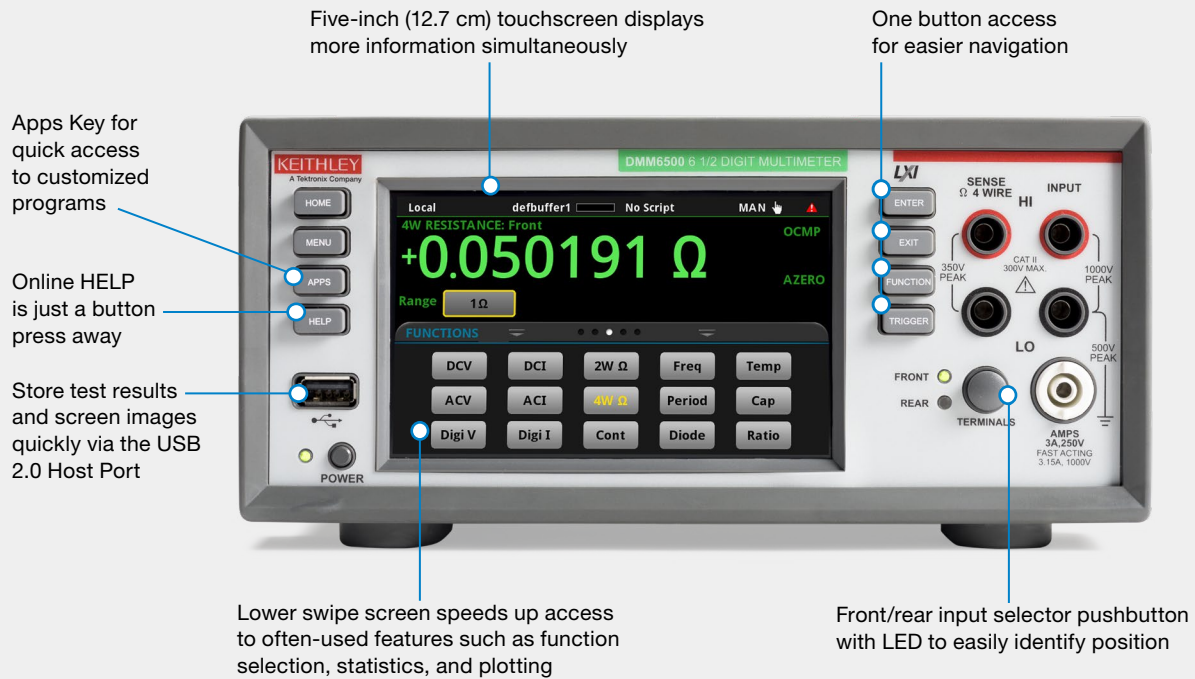

DMM6500 Rear Panel

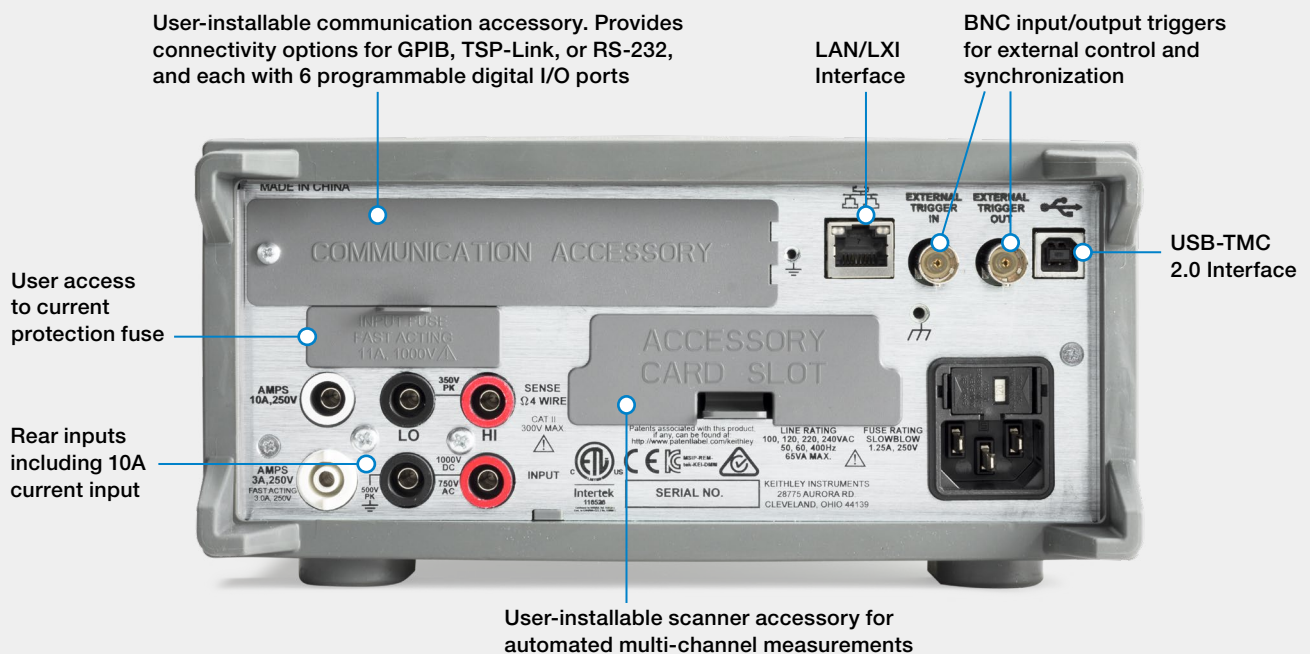

Multi-channel/Scanning Applications

When characterizing or profiling your design it is often critical to make a series of measurements. In these applications the need for automated multi-channel measurements is advantageous. The DMM6500 is equipped with a scanner card slot allowing up to 10 channels of switching, giving you the capability to make automated multi-channel measurements. Plugging in the 2000-SCAN card gives users up to 10 channels of 2-pole measurements or 5 channels of 4-pole measurements. Functions can be programmed on a per-channel basis if supported by the switch topology.



2000-SCAN 10-Channel Multiplexer.

Application Programs

The DMM6500 is factory installed with application programs to help you get more out of your instrument. These application programs appear when the instrument is used in the TSP or native SCPI communication language mode. These examples highlight the unique ability of the DMM6500 to run specialized applications which customize the user interface. This can significantly change the way information is displayed or even automated in performing an application



Menu of application programs that can customize the display or perform special functions.

Temperature Measurement Applications

Temperature is one of the most measured signal types in the world, and the DMM6500 has many options to help you make this measurement. Besides RTD, thermistor, and thermocouple functions, you can equip your DMM with a nine-channel scanner card with built-in CJC for automated thermocouple temperature scanning. This feature is very useful when your design requires thermal profiling, especially when enclosed in a temperature chamber.

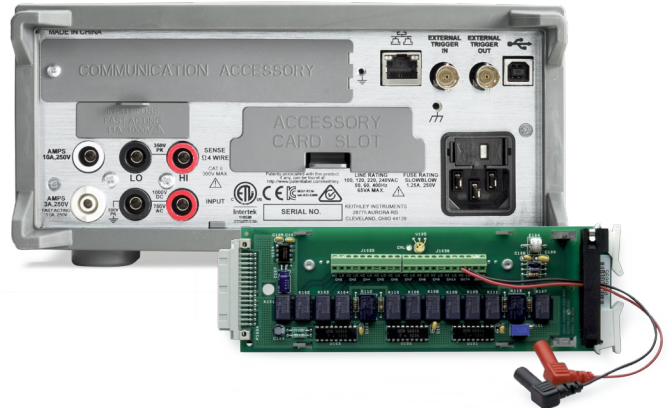

2001-TCSCAN 9-Channel Thermocouple Multiplexer and DMM6500 rear panel.

Ready to Use Instrument Drivers Simplify Programming

Prefer to create your own customized application software? Native National Instruments Labview®, IVI-C, and IVI-COM drivers are available for downloading to simplify the programming process. For the Labview® driver visit www.ni.com; for IVI drivers visit www.tek.com.

System Integration and Programming

Users have maximum programming flexibility with the DMM6500. In addition to traditional SCPI programming (default), the unit can also be configured for SCPI emulation for the Keithley 2000 or the Keysight 34401A. Additionally, Keithley’s powerful Test Script Processor (TSP®) programming is another option that allows unique single- or multi-instrument testing applications where speed is critical.

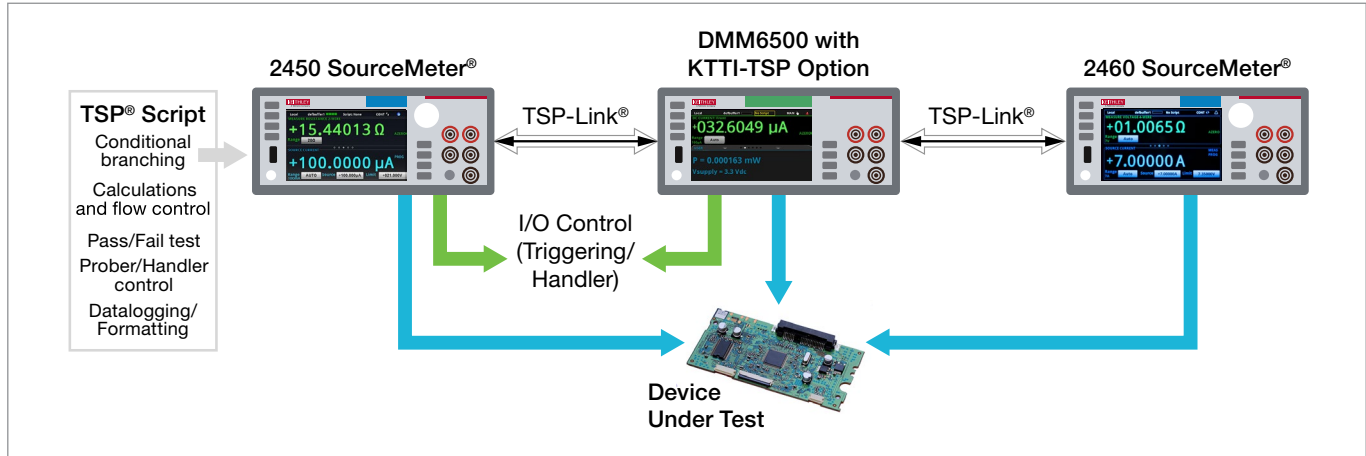

TSP System using TSP-Link for instrument to instrument communication.

TSP® scripting allows running powerful test scripts directly on the instrument, without the need for an external PC controller. These test scripts are complete test programs based on an easy-to-use yet highly efficient and compact scripting language, LUA (www.lua.org). Scripts are a collection of instrument control commands and/or program statements. Program statements control script execution and provide facilities such as variables, functions, branching, and loop control. This allows you to create powerful measurement applications without an integrated development environment (IDE). Test scripts can contain any sequence of routines that are executable by conventional programming languages (including decision-making algorithms), so the instrument can manage every facet of the test without the need to communicate with a PC for decision making. This eliminates delays due to GPIB, Ethernet, or USB traffic congestion and greatly improves test times.

```

1-- Define functions...
2function meas4WRes(nplcVal)
3  --Set measure function to 4-wire Res
4  dmm.measure.func = dmm.FUNC_4W_RESISTANCE
5
6  --Enable autorange.
7  dmm.measure.autorange = dmm.ON
8
9  --Enable autozero.
10 dmm.measure.autozero.enable = dmm.ON
11
12 --Enable OCOMP
13 dmm.measure.offsetcompensation.enable = dmm.ON
14
15 --Set the number of power line cycles
16 dmm.measure.nplc = nplcVal
17
18 --Read the resistance value.
19 return dmm.measure.read()
20end
21
22-- Run main code...
23-- Reset the Model DMM6500
24reset()
25
26-- Execute a 4W measurement
27print(meas4WRes(1.0))
    
```

TSP Scripting example showing 4-wire resistance.

TSP technology also offers mainframe-less channel expansion. The KTTI-TSP is a user installable accessory card offering connectivity to TSP-Link® technology. This channel expansion bus allows connecting multiple DMM6500’s or other TSP-enabled instruments together to form a tightly synchronized instrument system. Connection is provided with simple low cost Category 5 Ethernet cabling. The system is organized in a master-subordinate configuration, essentially allowing the connected instruments to act as one. Other Keithley TSP-enabled instruments include the 2450 and 2460 Graphical SourceMeter® SMU Instruments, Series 2600B SourceMeter® SMU Instruments, DMM7510, DAQ6510, and the Series 3700A Switch/Multimeter Measurement systems. TSP-Link technology supports up to 32 units, so it’s easy to scale a system to fit the requirements of an application.

KickStart Instrument PC Control Software

KickStart allows you to configure, test, and collect data from multiple instruments, including DMMs, power supplies, SMU instruments, and dataloggers. You can control up to eight instruments at the same time and retrieve millions of readings from each instrument. This makes KickStart a great solution for your datalogging needs and for capturing lots of data from transient events with a digitizing DMM.

Getting insights quickly is important, so KickStart plots your data immediately and dedicates a large portion of the viewing area to the graph, while also allowing you to view and edit the most essential parameters of other instruments in your test setup. Kickstart also includes comparison tools to allow you to plot and overlay data from the run history of each test.

Key KickStart features:

- Automate data collection from up to eight instruments
- Replicate tests quickly using saved test configurations
- Use statistical summaries and built-in plotting and comparison tools to quickly discover measurement anomalies and trends
- Export data in ready-to-use formats for additional analysis or to share test updates with your colleagues

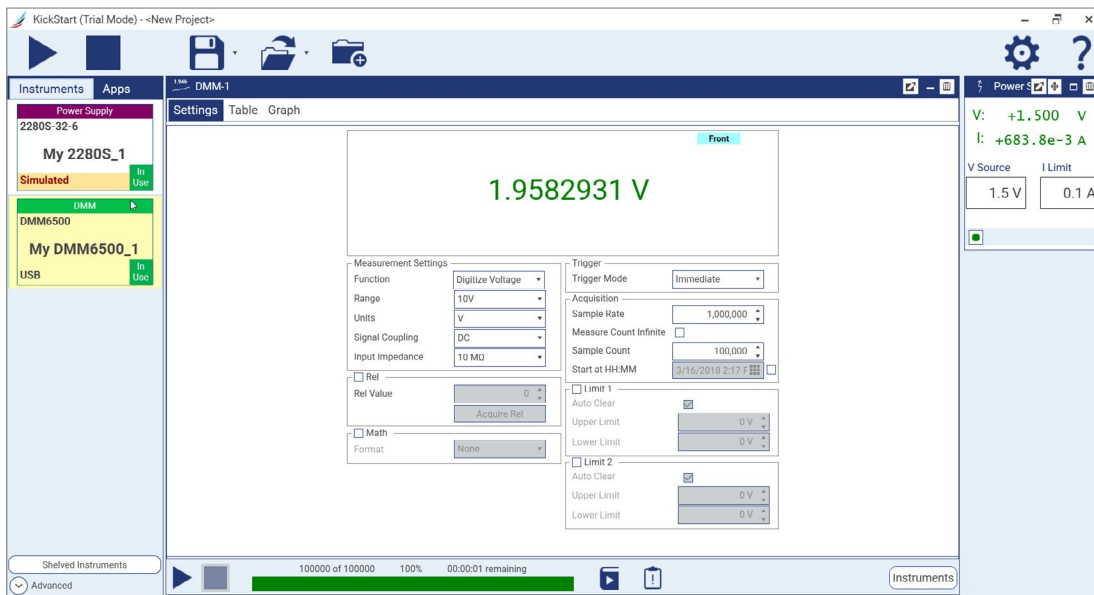

Kickstart allows you to perform and setup a test quickly and easily using a single point-and-click setup screen.

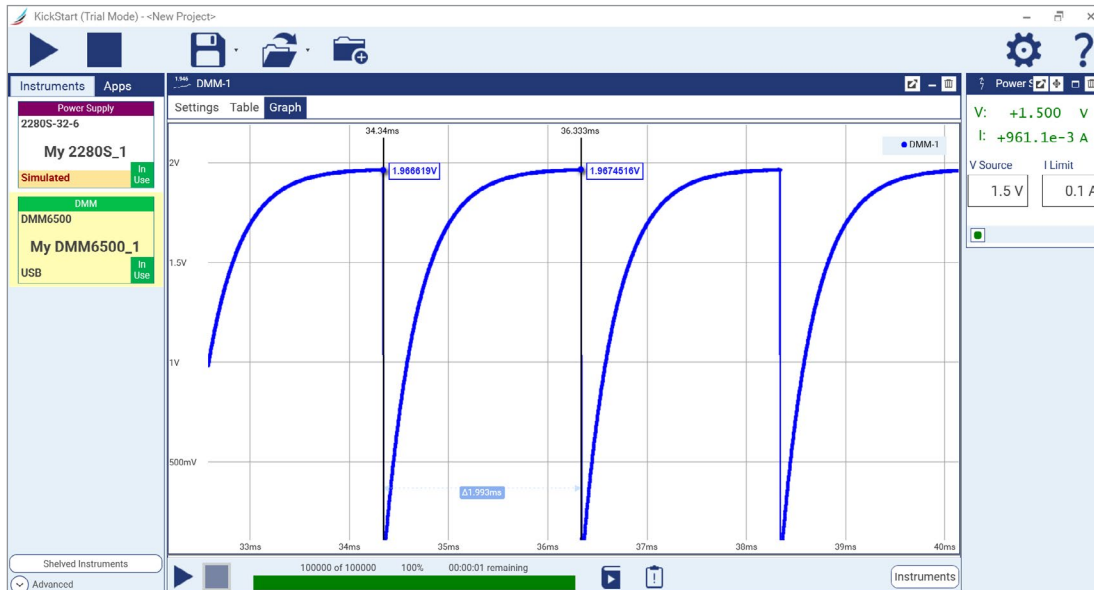

KickStart allows you to display data in both graphical and tabular formats. Mouse over the data in the graph to see exact values or use cursors to view detail on multiple data series at once.

Specification Conditions

This document contains specifications and supplemental information for the DMM6500 Multimeter System. Specifications are the standards against which the DMM6500 is tested. Upon leaving the factory, the DMM6500 meets these specifications. Supplemental and typical values are nonwarranted, apply at 23°C, and are provided solely as useful information. Measurement accuracies are specified for DMM6500 front or rear input terminals and include conversion error for thermocouple, thermistor, and RTD measurements.

Measurement Conditions Include:

- After a 30-minute warmup period.
- 1 PLC or 5 PLC measurement rate; for NPLC settings less than 1 PLC, add appropriate noise error from “Measurement Noise” table.
- Autozero enabled.
- Calibration period: one year (recommended) or two years. Calibration period may vary depending on customer requirements.
- 24-hour accuracy specification is relative to calibrator accuracy.
- Communication accessory card slot cover or an optional KTTI interface card is properly installed on the rear of the unit.

Definitions:

- **T_{CAL}** — The temperature at which the instrument was calibrated (23°C for factory calibration).
- **Temperature coefficient** — Additional uncertainty added for each°C outside T_{CAL} ±5°C.
- **Power Line Cycle (PLC)** — 16.67 ms at 60 Hz and 20 ms at 50 Hz or 400 Hz line frequency. Frequency automatically sensed at power up.

DC Voltage

DC Voltage Accuracy ±(% of reading + % of range)

Range	Resolution	Input Impedance	24 Hours T _{CAL} ±1°C	90 Days T _{CAL} ±5°C	1 Year T _{CAL} ±5°C	2 Years T _{CAL} ±5°C	Temperature Coefficient
100 mV	100 nV	>10 GΩ or 10 MΩ ±1%	0.0015 + 0.0030	0.0025 + 0.0035	0.0030 + 0.0035	0.0035 + 0.0035	0.0001 + 0.0005
1 V	1 μV	>10 GΩ or 10 MΩ ±1%	0.0015 + 0.0006	0.0020 + 0.0006	0.0025 + 0.0006	0.0030 + 0.0006	0.0001 + 0.0001
10 V	10 μV	>10 GΩ or 10 MΩ ±1%	0.0010 + 0.0004	0.0020 + 0.0005	0.0025 + 0.0005	0.0030 + 0.0005	0.0001 + 0.0001
100 V	100 μV	10 MΩ ±1%	0.0015 + 0.0006	0.0035 + 0.0006	0.0040 + 0.0006	0.0050 + 0.0006	0.0006 + 0.0001
1000 V ¹	1 mV	10 MΩ ±1%	0.0020 + 0.0006	0.0035 + 0.0006	0.0040 + 0.0006	0.0050 + 0.0006	0.0006 + 0.0001

Measurement Noise Characteristics and Rejection Ratios

Measurement Rate in NPLCs	Digits	DCV RMS Noise Uncertainty (in % of range + fixed base) ²	NMRR ³	CMRR ³
5 ⁴	6.5	0	100 dB	140 dB
5		0	60 dB	140 dB
1 ⁴		0	90 dB	140 dB
1		0	60 dB	140 dB
0.1 ⁴		0.00015 + 1 μV	40 dB	120 dB
0.1	5.5	0.00015 + 4 μV	--	120 dB
0.01		0.00030 + 6 μV	--	80 dB
0.0005	4.5	0.00500 + 40 μV	--	80 dB

DC Voltage Characteristics

Overrange	20% on 100 mV, 1 V, 10 V, and 100 V. 1% on 1000 V
ADC Linearity (10 V range)	0.0001% of 10 V range
Input Impedance	100 mV to 10 V Ranges: Selectable: (>10 GΩ or 10 MΩ ±1%) in parallel with <400 pF. 100 V to 1000 V Ranges: 10 MΩ ±1% in parallel with <400 pF
Input Bias Current	<50 pA at 23°C
Common Mode Current	<600 nA peak-peak at 50 Hz or 60 Hz
Earth Isolation	500 V _{peak} >10 GΩ and <300 pF any terminal to chassis
Common Mode Voltage	500 V _{peak} LO terminal to chassis maximum
Autozero Off Error	Add ±(0.0002% of range + 3 μV) within ±1°C and ≤10 minutes since last autozero Add ±(0.0010% of range + 10 μV) within ±5°C and ≤60 minutes since last autozero
Input Protection	Input HI 1100 V, Sense HI (SHI) and Sense LO (SLO) 350 V referenced to LO

Scanner Card Additional Uncertainties and Maximum Input Signal Levels

Scanner Card	Add the Following Uncertainty	Maximum Input Signal Level
2000-SCAN	1 μV	110 V
2001-TCSCAN	1 μV	110 V

Notes

- For each additional volt over ±500 V, add 0.02 mV of uncertainty.
- Noise values apply to terminals using a low-thermal short for 50 Hz and 60 Hz operation only. Measurements through a card may introduce additional noise.
- NMRR for line frequency ±0.1%. For DC common mode and 1 kΩ unbalance on LO terminal, rejection of AC common mode signals is >80 dB for line frequency ±0.1%.
- Line sync on.

Resistance

Resistance Accuracy \pm (% of reading + % of range)⁵

Range	Resolution	Test Current ($\pm 5\%$)	Open Circuit Voltage ($\pm 5\%$)	24 Hours $T_{CAL} \pm 1^\circ C$	90 Days $T_{CAL} \pm 5^\circ C$	1 Year $T_{CAL} \pm 5^\circ C$	2 Years $T_{CAL} \pm 5^\circ C$	Temperature Coefficient
1 Ω ⁶	1 $\mu\Omega$	10 mA	12.5 V	0.0080 + 0.0200	0.0080 + 0.0200	0.0085 + 0.0200	0.0100 + 0.0200	0.0006 + 0.0010
10 Ω ⁶	10 $\mu\Omega$	10 mA	12.5 V	0.0020 + 0.0020	0.0080 + 0.0020	0.0085 + 0.0020	0.0100 + 0.0020	0.0006 + 0.0001
100 Ω	100 $\mu\Omega$	1 mA	9.2 V	0.0020 + 0.0020	0.0075 + 0.0020	0.0085 + 0.0020	0.0100 + 0.0020	0.0006 + 0.0001
1 k Ω	1 m Ω	1 mA	9.2 V	0.0020 + 0.0006	0.0065 + 0.0006	0.0075 + 0.0006	0.0090 + 0.0006	0.0006 + 0.0001
10 k Ω	10 m Ω	100 μA	12.7 V	0.0020 + 0.0006	0.0065 + 0.0006	0.0075 + 0.0006	0.0090 + 0.0006	0.0006 + 0.0001
100 k Ω	100 m Ω	10 μA	12.5 V	0.0020 + 0.0006	0.0070 + 0.0010	0.0075 + 0.0010	0.0100 + 0.0010	0.0006 + 0.0001
1 M Ω	1 Ω	10 μA	12.5 V	0.0020 + 0.0006	0.0075 + 0.0006	0.0100 + 0.0006	0.0120 + 0.0006	0.0006 + 0.0001
10 M Ω ⁷	10 Ω	0.7 μA II 10 M Ω	7.1 V	0.0150 + 0.0006	0.0200 + 0.0010	0.0400 + 0.0010	0.0450 + 0.0010	0.0070 + 0.0001
100 M Ω ⁷	100 Ω	0.7 μA II 10 M Ω	7.1 V	0.0800 + 0.0030	0.2000 + 0.0030	0.2000 + 0.0030	0.2500 + 0.0030	0.0385 + 0.0001

Resistance Measurement Noise Characteristics⁸

Measurement Rate in NPLC	Digits	2-wire RMS Noise Uncertainty (in % of range + fixed base)	4-wire RMS Noise Uncertainty, Offset Compensation OFF (in % of range + fixed base) ⁹	4-wire RMS noise uncertainty, offset compensation ON (in % of range + fixed base) ⁹
5	6.5	0	0	0
1		0	0	0
0.1 ¹⁰		0.00015 + 0.10 m Ω	0.00020 + 0.20 m Ω	0.00030 + 0.25 m Ω
0.1	5.5	0.00050 + 0.35 m Ω	0.00180 + 2.00 m Ω	0.00350 + 3.50 m Ω
0.01		0.00070 + 0.50 m Ω	0.00260 + 2.50 m Ω	0.00500 + 4.00 m Ω
0.0005	4.5	0.00650 + 3.50 m Ω	0.01000 + 7.00 m Ω	0.01500 + 10.00 m Ω

Resistance Characteristics

Overrange 20% on all ranges

Autozero Off Error Add $\pm(0.0005\%$ of range + 5 m Ω) within $\pm 1^\circ C$ and ≤ 10 minutes since last autozero
Add $\pm(0.0020\%$ of range + 10 m Ω) within $\pm 5^\circ C$ and ≤ 60 minutes since last autozero

Offset Compensation Selectable on 1 Ω , 10 Ω , 100 Ω , 1 k Ω , and 10 k Ω ranges, 4-wire mode only

Maximum 4-wire Lead Resistance 5 Ω per lead for 1 Ω range
10% of range per lead for 10 Ω , 100 Ω , 1 k Ω , and 10 k Ω ranges
1 k Ω per lead for 100 k Ω , 1 M Ω , 10 M Ω , and 100 M Ω

Open Lead Detector Selectable on all ranges, 4-wire mode only; default is off.

Input Protection Input HI 1100 V, Sense HI (SHI) and Sense LO (SLO) 350 V referenced to LO

Scanner Card Additional Contact Resistance

Scanner Card	Contact Resistance
2000-SCAN	1 Ω at end of life
2001-TCSCAN	1 Ω at end of life

Notes

- Specifications are for 2- and 4-wire resistance. For 2-wire, use relative offset and add 100 m Ω of additional uncertainty. For 4-wire, turn offset compensation on for ≤ 10 k Ω and off for > 10 k Ω . The 1 Ω range is for 4-wire only.
- Requires a 10-reading digital filter at 1 PLC or 2-reading digital filter at 5 PLC.
- Specified for $< 10\%$ lead-resistance mismatch at HI and LO.
- Applies for 1 Ω through 1 M Ω ranges. For 100 Ω range, multiply the listed values by five. Noise values apply to terminals using a low-thermal short for 50 Hz and 60 Hz operation only. Measurements through a card may introduce additional noise.
- Open lead detection off.
- Line sync on.

DC Current

DC Current Accuracy \pm (% of reading + % of range)

Range	Resolution	Burden Voltage	24 Hours $T_{CAL} \pm 1^{\circ}C$	90 Days $T_{CAL} \pm 5^{\circ}C$	1 Year $T_{CAL} \pm 5^{\circ}C$	2 Years $T_{CAL} \pm 5^{\circ}C$	Temperature Coefficient
10 μ A	10 pA	<0.13 V	0.007 + 0.002	0.035 + 0.005	0.045 + 0.005	0.055 + 0.005	0.0030 + 0.0006
100 μ A	100 pA	<0.14 V	0.010 + 0.020	0.035 + 0.005	0.045 + 0.005	0.055 + 0.005	0.0020 + 0.0005
1 mA	1 nA	<0.17 V	0.007 + 0.006	0.035 + 0.005	0.045 + 0.005	0.055 + 0.005	0.0020 + 0.0005
10 mA	10 nA	<0.17 V	0.006 + 0.003	0.018 + 0.005	0.020 + 0.005	0.025 + 0.005	0.0015 + 0.0005
100 mA	100 nA	<0.20 V ¹¹	0.010 + 0.030	0.015 + 0.005	0.020 + 0.005	0.025 + 0.005	0.0015 + 0.0005
1 A	1 μ A	<0.55 V ¹¹	0.020 + 0.004	0.030 + 0.005	0.040 + 0.005	0.050 + 0.005	0.0030 + 0.0005
3 A	1 μ A	<1.70 V ¹¹	0.030 + 0.004	0.040 + 0.004	0.050 + 0.004	0.060 + 0.004	0.0030 + 0.0005
10 A ¹²	10 μ A	<0.50 V	0.140 + 0.025	0.190 + 0.025	0.220 + 0.025	0.250 + 0.025	0.0060 + 0.0005

DC Current Characteristics

Overrange 20% on 10 μ A, 100 μ A, 1 mA, 10 mA, 100 mA, and 1 A ranges
1% on 3 A and 10 A ranges

Terminal Input Protection Externally accessible 3 A, 250 V fast-acting fuse, 5 x 20 mm
Keithley replacement part number FU-99-1

Externally accessible 11 A and 1000 V fuse
Keithley replacement part number (11A) 159-0583-00

Autozero Off Error Add $\pm 0.004\%$ of range within $\pm 1^{\circ}C$ and ≤ 10 minutes since last autozero
Add $\pm 0.015\%$ of range within $\pm 5^{\circ}C$ and ≤ 60 minutes since last autozero

Nominal Shunt Resistance¹³

10 μ A	100 μ A	1 mA	10 mA	100 mA	1 A	3 A	10 A
10 k Ω	1 k Ω	100 Ω	10 Ω	1 Ω	100 m Ω	100 m Ω	5 m Ω

DC Current Measurement Noise Characteristics¹⁴

Measurement Rate in NPLC	Digits	Additional Noise Error (in % of range + fixed base)
5	6.5	0
1		0
0.1 ¹⁵		0.0009 + 10.0 pA
0.1	5.5	0.0015 + 3.5 nA
0.01		0.0030 + 3.5 nA
0.0005	4.5	0.0200 + 5.0 nA

Notes

11. When using the rear terminals, add 0.1 V to the 100 mA range and 0.5 V to the 1 A and 3 A ranges.
12. For each additional ampere over ± 6 A, add 2 mA of uncertainty. Operation for >1000 hours with a signal level of >7 A, add 0.05% of reading uncertainty for every 1000 hours.
13. Guaranteed by design.
14. Noise values apply to open terminals. Measurements through a card may introduce additional noise.
15. Line sync on.

Temperature

Thermocouple Accuracy $\pm^{\circ}\text{C}$ ¹⁶

Type	Resolution	Range	2 Year Accuracy $T_{\text{CAL}} \pm 5^{\circ}\text{C}$; all uncertainties in $^{\circ}\text{C}$			Temperature Coefficient in $^{\circ}\text{C}/^{\circ}\text{C}$
			Simulated or External CJC		Internal CJC (on module)	
			Front/Rear Terminals	2001-TCSCAN	2001-TCSCAN	
J	0.001 $^{\circ}\text{C}$	0 $^{\circ}$ to 760 $^{\circ}\text{C}$	0.20	0.20	0.65	0.03
		-200 $^{\circ}$ to <0 $^{\circ}\text{C}$	0.20	0.20	0.65	0.03
K	0.001 $^{\circ}\text{C}$	0 $^{\circ}$ to 1372 $^{\circ}\text{C}$	0.20	0.20	0.70	0.03
		-200 $^{\circ}$ to <0 $^{\circ}\text{C}$	0.30	0.30	0.70	0.03
N	0.001 $^{\circ}\text{C}$	0 $^{\circ}$ to 1300 $^{\circ}\text{C}$	0.20	0.20	0.70	0.03
		-200 $^{\circ}$ to <0 $^{\circ}\text{C}$	0.50	0.60	1.50	0.03
T	0.001 $^{\circ}\text{C}$	0 $^{\circ}$ to 400 $^{\circ}\text{C}$	0.20	0.20	0.70	0.03
		-200 $^{\circ}$ to <0 $^{\circ}\text{C}$	0.30	0.30	0.70	0.03
E	0.001 $^{\circ}\text{C}$	0 $^{\circ}$ to 1000 $^{\circ}\text{C}$	0.20	0.20	0.70	0.03
		-200 $^{\circ}$ to <0 $^{\circ}\text{C}$	0.20	0.30	0.70	0.03
R	0.010 $^{\circ}\text{C}$	600 $^{\circ}$ to 1768 $^{\circ}\text{C}$	0.40	0.50	1.30	0.03
		0 $^{\circ}$ to <600 $^{\circ}\text{C}$	0.80	1.00	1.30	0.03
S	0.010 $^{\circ}\text{C}$	600 $^{\circ}$ to 1768 $^{\circ}\text{C}$	0.40	0.50	1.30	0.03
		0 $^{\circ}$ to <600 $^{\circ}\text{C}$	0.80	1.00	1.30	0.03
B	0.010 $^{\circ}\text{C}$	1100 $^{\circ}$ to 1820 $^{\circ}\text{C}$	0.40	0.50	1.65	0.03
		350 $^{\circ}$ to <1100 $^{\circ}\text{C}$	1.20	1.50	1.65	0.03

Resistance Temperature Detector (RTD) Accuracy $\pm^{\circ}\text{C}$

Types: 100 Ω platinum PT100, D100, F100, PT385, and PT3916 or user-configurable 0 Ω to 10 k Ω

Measurement Method	Resolution	Range	2 Year Accuracy $T_{\text{CAL}} \pm 5^{\circ}\text{C}$	Temperature Coefficient in $^{\circ}\text{C}/^{\circ}\text{C}$
2-wire ¹⁷	0.01 $^{\circ}\text{C}$	-200 $^{\circ}$ to 850 $^{\circ}\text{C}$	0.80	0.003
3-wire ¹⁸	0.01 $^{\circ}\text{C}$	-200 $^{\circ}$ to 600 $^{\circ}\text{C}$	0.35	0.003
		>600 $^{\circ}$ to 850 $^{\circ}\text{C}$	0.37	0.003
4-wire	0.01 $^{\circ}\text{C}$	-200 $^{\circ}$ to 600 $^{\circ}\text{C}$	0.06	0.003
		>600 $^{\circ}$ to 850 $^{\circ}\text{C}$	0.12	0.003

Thermistor Accuracy $\pm^{\circ}\text{C}$

Types: 2.2 k Ω , 5 k Ω , and 10 k Ω

Measurement Method	Resolution	Range	2 Year Accuracy $T_{\text{CAL}} \pm 5^{\circ}\text{C}$	Temperature Coefficient in $^{\circ}\text{C}/^{\circ}\text{C}$
2-wire	0.01 $^{\circ}\text{C}$	80 $^{\circ}$ to 150 $^{\circ}\text{C}$	0.08	0.002

For readings >70 $^{\circ}\text{C}$, add this additional uncertainty per Ω of lead, channel, and contact resistance

Thermistor Type	Common Model Number	70 $^{\circ}$ to 100 $^{\circ}\text{C}$	>100 $^{\circ}$ to 150 $^{\circ}\text{C}$
2.2 k Ω	44004	0.22 $^{\circ}\text{C}$ per Ω	1.11 $^{\circ}\text{C}$ per Ω
5 k Ω	44007	0.10 $^{\circ}\text{C}$ per Ω	0.46 $^{\circ}\text{C}$ per Ω
10 k Ω	44006	0.04 $^{\circ}\text{C}$ per Ω	0.19 $^{\circ}\text{C}$ per Ω

Notes

16. Accuracy excludes probe errors.

17. Specifications do not include errors that may arise from user's cable or terminal resistance.

18. 3-wire RTD accuracy is for <0.1 Ω lead-resistance mismatch for input HI and LO. Add 0.25 $^{\circ}\text{C}$ per 0.1 Ω of HI-LO resistance mismatch.

Temperature Characteristics

Thermocouple Conversion	ITS-90
Thermocouple Reference Junction	External (CJC on 2001-TCSCAN or user-provided with 2000-SCAN) or simulated (fixed)
Open Thermocouple Detection	Selectable per channel (open >130 kΩ; default on)
Earth Isolation	500 V _{PEAK} > 0 GΩ and <300 pF any terminal to chassis

AC Voltage

AC Voltage Accuracy ±(% of reading + % of range)¹⁹

Range	Resolution	Calibration Cycle	3 Hz to 5 Hz	5 Hz to 10 Hz	10 Hz to 20 kHz	20 kHz to 50 kHz	50 kHz to 100 kHz	100 kHz to 300 kHz
100 mV	100 nV	24 hours	1.00 + 0.02	0.35 + 0.02	0.04 + 0.02	0.10 + 0.04	0.55 + 0.08	4.00 + 0.50
1 V	1 μV	90 days	1.00 + 0.03	0.35 + 0.03	0.05 + 0.03	0.11 + 0.05	0.60 + 0.08	4.00 + 0.50
10 V	10 μV							
100 V	100 μV	1 year	1.00 + 0.03	0.35 + 0.03	0.06 + 0.03	0.12 + 0.05	0.60 + 0.08	4.00 + 0.50
750 V	100 μV	2 years	1.00 + 0.03	0.35 + 0.03	0.07 + 0.03	0.13 + 0.05	0.60 + 0.08	4.00 + 0.50
Temperature Coefficient			0.100 + 0.003	0.035 + 0.003	0.005 + 0.003	0.011 + 0.005	0.060 + 0.08	0.200 + 0.020

AC Voltage Characteristics

Overrange (voltages in V _{RMS})	20% on 100 mV, 1 V, 10 V, and 100 V ranges. 0% for 750 V range						
AC Measurement Method	AC-coupled digital sampling with anti-alias filter						
Crest Factor (excludes sine wave)	Crest factors of up to 3:1 at full-scale input or 10:1 maximum, whichever is greater. Autorange selects optimum range for crest factor up to 10:1. Accuracy specifications apply to all crest factors and are limited to a product of (crest factor) × (fundamental frequency) ≤ 3 kHz.						
Volt*Hertz Product	≤8 × 10 ⁷ V*Hz ²⁰						
Common Mode Rejection Ratio	>70 dB, for 1 kΩ unbalance in LO lead						
Detector Bandwidth	Setting of 3 Hz, 30 Hz, or 300 Hz sets maximum measurement aperture of 200 ms, 20 ms, or 2 ms, respectively; only signals with frequency greater than the detector bandwidth are measured.						
Input Impedance	1.1 MΩ ±2%, in parallel with <100 pF						
Input Protection	1100 V _{peak}						
Maximum DCV	400 V on any ACV range						
ACV Frequency	Frequency reading automatically returned in reading buffer when in full buffer mode. Frequency readings are specified as in the frequency and period table.						
Scanner Card Maximum Input Signal Levels							
	<table border="1"> <thead> <tr> <th>Module</th> <th>Maximum input signal level</th> </tr> </thead> <tbody> <tr> <td>2000-SCAN</td> <td>125 V_{RMS}/175 V_{peak}</td> </tr> <tr> <td>2001-TCSCAN</td> <td>125 V_{RMS}/175 V_{peak}</td> </tr> </tbody> </table>	Module	Maximum input signal level	2000-SCAN	125 V _{RMS} /175 V _{peak}	2001-TCSCAN	125 V _{RMS} /175 V _{peak}
Module	Maximum input signal level						
2000-SCAN	125 V _{RMS} /175 V _{peak}						
2001-TCSCAN	125 V _{RMS} /175 V _{peak}						

Notes

19. Specifications are for sine wave inputs >5% of range.
 20. Guaranteed by design.

AC Current

AC Current Accuracy ± (% of reading + % of range)²¹

Range	Resolution	Burden Voltage	Frequency	24 Hours T _{CAL} ±1°C	90 Days T _{CAL} ±5°C	1 Year T _{CAL} ±5°C	2 Years T _{CAL} ±5°C	Temperature Coefficient
100 µA	100 pA	<0.14 V	3 Hz – 1 kHz	0.10 + 0.07	0.10 + 0.07	0.10 + 0.07	0.10 + 0.07	0.015 + 0.010
			>1 kHz – 10 kHz ²²	0.15 + 0.07	0.15 + 0.07	0.15 + 0.07	0.15 + 0.07	0.030 + 0.010
1 mA	1 nA	<0.17 V	3 Hz – 5 kHz	0.10 + 0.04	0.10 + 0.04	0.10 + 0.04	0.10 + 0.04	0.015 + 0.006
			>5 kHz – 10 kHz ²²	0.10 + 0.04	0.10 + 0.04	0.10 + 0.04	0.10 + 0.04	0.030 + 0.006
10 mA	10 nA	<0.17 V	3 Hz – 5 kHz	0.10 + 0.04	0.10 + 0.04	0.10 + 0.04	0.10 + 0.04	0.015 + 0.006
			>5 kHz – 10 kHz ²²	0.10 + 0.04	0.10 + 0.04	0.10 + 0.04	0.10 + 0.04	0.030 + 0.006
100 mA	100 nA	<0.20 V ²³	3 Hz – 5 kHz	0.10 + 0.04	0.10 + 0.04	0.10 + 0.04	0.10 + 0.04	0.015 + 0.006
			>5 kHz – 10 kHz ²²	0.10 + 0.04	0.10 + 0.04	0.10 + 0.04	0.10 + 0.04	0.030 + 0.006
1 A	1 µA	<0.75 V ²³	3 Hz – 5 kHz ²⁴	0.10 + 0.04	0.10 + 0.04	0.10 + 0.04	0.10 + 0.04	0.015 + 0.006
			>5 kHz – 10 kHz ²²	0.15 + 0.06	0.15 + 0.06	0.15 + 0.06	0.15 + 0.06	0.030 + 0.006
3 A	1 µA	<1.70 V ²³	3 Hz – 5 kHz ²⁴	0.15 + 0.06	0.15 + 0.06	0.15 + 0.06	0.15 + 0.06	0.015 + 0.006
			>5 kHz – 10 kHz ²²	0.15 + 0.06	0.15 + 0.06	0.15 + 0.06	0.15 + 0.06	0.030 + 0.006
10 A	10 µA	<0.50 V	3 Hz – 1 kHz ²⁴	0.40 + 0.06	0.40 + 0.06	0.40 + 0.06	0.40 + 0.06	0.015 + 0.006
			>1 kHz – 5 kHz	1.00 + 0.07	1.00 + 0.07	1.00 + 0.07	1.00 + 0.07	0.030 + 0.012
			>5 kHz – 10 kHz ²²	1.00 + 0.07	1.00 + 0.07	1.00 + 0.07	1.00 + 0.07	0.030 + 0.012

AC Current Characteristics

Overrange	20% on 100 µA, 1 mA, 10 mA, 100 mA, and 1 A ranges 1% on 3 A and 10 A ranges
AC Measurement Type	AC-coupled True RMS; measures the AC component of the input Digital sampling with anti-alias filter
Input Protection	See DC current characteristics.
Crest Factor²⁵ (excludes sine wave)	10:1 maximum crest factor (1.75:1 at full-scale) Autorange selects optimum range for crest factor up to 10:1 Accuracy specifications apply to all crest factors less than 5 and are limited to the product of (crest factor) × (fundamental frequency) ≤ 200 Hz.
ACI Frequency	Frequency readings are automatically returned in the reading buffer when in full buffer mode. Frequency values are typical.
Nominal Shunt Resistance²⁶	100 µA: 1 kΩ, 1 mA: 100 Ω, 10 mA: 10 Ω, 100 mA: 1 Ω, 1 A: 100 mΩ, 3 A: 100 mΩ, 10 A: 5 mΩ

Notes

21. Specifications are for sine wave inputs >5% of range and >10 µA_{RMS}.
 22. Typical performance for the indicated frequency ranges.
 23. When using the rear terminals, add 0.1 V to the 100 mA range and 0.5 V to the 1 A and 3 A ranges.
 24. For signals of <5 Hz, add 0.2% of reading uncertainty.
 25. 100 µA range is specified only for crest factors <3.
 26. Guaranteed by design.

Frequency and Period

Frequency and Period Accuracy \pm (% of reading)²⁷

Range	Resolution	Frequency	Period	2 Year Accuracy $T_{CAL} \pm 5^{\circ}C$	Temperature Coefficient in $^{\circ}C/^{\circ}C$
100 mV to 750 V (For signals $>5\%$ of range and >10 mV _{RMS})	0.0001% of reading	3 Hz to 10 Hz	333 ms to 100 ms	0.100	0.0002
		>10 Hz to 100 Hz	<100 ms to 10 ms	0.030	0.0002
		>100 Hz to 1 kHz	<10 ms to 1 ms	0.010	0.0002
		>1 kHz to 300 kHz	<1 ms to 3.3 μ s	0.009	0.0002
		Square Wave ²⁸		0.008	0.0002

Frequency and Period Characteristics

Measurement Method Reciprocal-counting technique; measurement is AC-coupled using AC measurement functions.

Voltage Ranges 100 mV_{RMS} full scale to 750 V_{RMS}; auto or manual ranging.

Gate Time User definable from 2 ms to 273 ms (default 200 ms)

Continuity

Continuity Accuracy 2-Wire \pm (% of reading + % of range)²⁹

Range	Resolution	Test Current	Open Circuit Voltage ($\pm 5\%$)	2 Year Accuracy $T_{CAL} \pm 5^{\circ}C$	Temperature Coefficient
1 k Ω	100 m Ω	1 mA	9.2 V	0.010 + 0.010	0.0006 + 0.0001

Capacitance

Capacitance Accuracy \pm (% of reading + % of range)³⁰

Range	Resolution	Charge Current ($\pm 5\%$) ³¹	2 Year Accuracy $T_{CAL} \pm 5^{\circ}C$	Temperature Coefficient
1 nF	0.1 pF	1 μ A	0.80 + 0.50	0.05 + 0.05
10 nF	1 pF	10 μ A	0.40 + 0.10	0.05 + 0.01
100 nF	10 pF	100 μ A	0.40 + 0.10	0.05 + 0.01
1 μ F	0.1 nF	100 μ A	0.40 + 0.10	0.05 + 0.01
10 μ F	1 nF	1 mA	0.40 + 0.10	0.05 + 0.01
100 μ F	10 nF	1 mA	0.40 + 0.10	0.05 + 0.01

Capacitance Characteristics

Overrange 20% on all ranges.

Measurement Method Constant current slope measurement.

Maximum Voltage and Voltage Clamp

For all devices: Clamped by hardware to <3 V.

Notes

27. Specifications apply for sine wave input; detector bandwidth of 3 Hz. For detector bandwidth 30 Hz, add 100 mHz uncertainty. For detector bandwidth 300 Hz, add 1 Hz uncertainty.

28. Used for square waves with amplitude $> 10\%$ of range and 10 Hz to 300 kHz.

29. Does not include the user's lead-resistance.

30. Accuracies are specified for cable, channel, and other stray connector capacitance properly zeroed with the REL function.

31. Discharge current limited to <10 mA.

Diode

Diode Voltage Accuracy \pm (% of reading + additional uncertainty)³²

Voltage Measure Range	Resolution	Maximum Voltage Measurement	Test Current ($\pm 5\%$)	2 Year Accuracy $T_{CAL} \pm 5^{\circ}C$	Temperature Coefficient
10 V	10 μV	12 V	10 μA	0.0045 + 60.0 μV	0.0008 + 10 μV
		10 V	100 μA	0.0045 + 80.0 μV	0.0008 + 10 μV
		7 V	1 mA	0.0045 + 170.0 μV	0.0010 + 10 μV
		7 V	10 mA	0.0045 + 1.1 mV	0.0010 + 10 μV

Digitize

Digitize DC Voltage Accuracy \pm (% of reading + % of range)³³

Range	Resolution	Input Impedance	2 Year Accuracy $T_{CAL} \pm 5^{\circ}C$	Temperature Coefficient
100 mV	10 μV	>10 G Ω or 10 M Ω $\pm 1\%$	0.040 + 0.020	0.0025 + 0.0030
1 V	100 μV	>10 G Ω or 10 M Ω $\pm 1\%$	0.030 + 0.010	0.0025 + 0.0010
10 V	1 mV	>10 G Ω or 10 M Ω $\pm 1\%$	0.030 + 0.010	0.0025 + 0.0010
100 V	10 mV	10 M Ω $\pm 1\%$	0.030 + 0.010	0.0025 + 0.0010
1000 V	100 mV	10 M Ω $\pm 1\%$	0.030 + 0.010	0.0025 + 0.0010

Digitize DC Current Accuracy \pm (% of reading + % of range)³³

Range	Resolution	Burden Voltage	2 Year Accuracy $T_{CAL} \pm 5^{\circ}C$	Temperature Coefficient
100 μA	10 nA	<0.14 V	0.07 + 0.05	0.0030 + 0.0035
1 mA	100 nA	<0.17 V	0.07 + 0.03	0.0030 + 0.0035
10 mA	1 μA	<0.17 V	0.05 + 0.03	0.0030 + 0.0035
100 mA	10 μA	<0.20 V ³⁴	0.05 + 0.03	0.0020 + 0.0035
1 A	100 μA	<0.55 V ³⁴	0.07 + 0.03	0.0040 + 0.0035
3 A	100 μA	<1.70 V ³⁴	0.09 + 0.04	0.0040 + 0.0035
10 A	1 mA	<0.50 V	0.25 + 0.08	0.0060 + 0.0100

Notes

32. Specifications do not include errors that may arise from user's cable or connection resistance.

33. DC accuracy specified with 1000 samples per second, 100-reading digital filter.

34. When using the rear terminals, add 0.1 V to the 100 mA range and 0.5 V to the 1 A and 3 A ranges.

Typical Digitize Signal Characteristics

1 dB full-scale of range

Function: Range	Spur-free Range SFDR (1 kHz / 10 kHz / 50 kHz)	THD + Noise SNDR (1 kHz / 10 kHz / 50 kHz)	Bandwidth (-3 dB, 5%)	Effective Number of Bits (1 kHz/10 kHz/50 kHz)
DCV: 100 mV	75 / 70 / 50	65 / 60 / 50	210 kHz	9 / 9 / 7
DCV: 1 V	95 / 90 / 75	80 / 80 / 75	210 kHz	12 / 12 / 11
DCV: 10 V	95 / 80 / 70	90 / 80 / 70	440 kHz	13 / 12 / 10
DCV: 100 V	50 / 35 / 25	50 / 40 / 30	17 kHz	10 / 8 / 7
DCV: 1000 V	50 / 35 / 25	50 / 40 / 30	17 kHz	13 / 11 / 10
DCI: 100 μA	80 / 65 / 45	70 / 65 / 45	430 kHz	12 / 10 / 8
DCI: 1 mA	80 / 65 / 45	70 / 65 / 45	570 kHz	12 / 10 / 8
DCI: 10 mA	80 / 65 / 45	70 / 65 / 45	230 kHz	12 / 10 / 8
DCI: 100 mA	80 / 65 / 45	70 / 65 / 45	340 kHz	12 / 10 / 8
DCI: 1 A	70 / 50 / 40	65 / 50 / 40	25 kHz	11 / 8 / 7
DCI: 3 A	70 / 50 / 40	65 / 50 / 40	25 kHz	11 / 8 / 7
DCI: 10 A	45 / 25 / 20	43 / 30 / 30	40 kHz	7 / 5 / 5

Digitizing Additional Characteristics

Maximum Resolution 16 bits

Measurement Input Coupling DC coupled

Sampling Rate Programmable 1 k through 1 MS/s

Minimum Record Time 1 μs

Maximum Record Length (Volatile) Up to 7 million with standard buffer (includes channel and formatting information)

DC Voltage Ratio

DC Voltage Ratio Calculation ³⁵

Method	Measurement
Channel Ratio (through rear input scanner card)	$\text{Channel Ratio} = \frac{\text{Channel A}}{\text{Channel B}}$ $\text{Accuracy} = (\text{Accuracy of channel A measure range} + \text{Accuracy of channel B measure range}) \times \text{Channel ratio}$
Channel Average (through rear input scanner card)	$\text{Channel Average} = \frac{\text{Channel A} + \text{Channel B}}{2}$ $\text{Accuracy} = \text{Accuracy of channel A measure range} + \text{Accuracy of paired channel B measure range}$
DCV Input Ratio (HI-LO/SHI-SLO) ³⁶	$\text{Ratio} = \frac{\text{HI signal}}{\text{SHI signal} - \text{SLO signal}}$ $\text{Accuracy} = \left(\frac{\text{HI range}}{\text{HI signal}} \times \text{DCV\% of range accuracy} + \frac{10 \text{ V}}{\text{SHI signal} - \text{SLO signal}} \times 0.0008\% \right) \times \text{Ratio}$

Notes

35. See DC Voltage Accuracy. SHI and SLO: 10 V range only. SHI and SLO (sense) terminals referenced to LO input. Maximum voltage referenced to LO 12 V.

36. Sense terminals on inputs are limited to 10 V range during ratio measurement. Add 0.0015% + 0.0005% per °C temperature coefficient to DCV percent of range accuracy when using the 100 V or 1000 V range on the input terminals.

System Specifications

Typical Reading Rates, DC Functions^{37, 38}

60 Hz (50 Hz) Operation

NPLC	Functions: DCV (10 V) 2-wire Ω (≤ 10 k Ω), DCI (1 mA)		Functions: 4-wire Ω (≤ 1 k Ω) 4-wire and 3-wire RTD		Function: Thermistor or Thermocouple	
	Measurements (readings per second) ³⁹					
	Buffer	Computer	Buffer	Computer	Buffer	Computer
5	12 (10)	11 (9)	5 (4)	5 (4)	12 (10)	11 (9)
1	59 (48)	58 (48)	28 (23)	28 (23)	59 (49)	57 (48)
0.1	584 (490)	440 (380)	180 (160)	170 (150)	580 (480)	440 (380)
0.01	4900 (4100)	4800 (4100)	400 (390)	400 (390)	4800 (4100)	4700 (4000)
0.0005	20600 (20600)	19800 (19800)	460 (460)	460 (460)	21000 (21000)	20300 (20300)

Typical Reading Rates, AC Functions³⁷

60 Hz (50 Hz) Operation

Function: ACV, ACI	Function: Frequency, Period	Measurements (readings per second)
Detector Bandwidth	Aperture	Buffer or Computer
3 Hz	200 ms	1
30 Hz	20 ms	10
300 Hz	2 ms	100

Scanning/Multiple Channels (with optional scan cards)⁴⁰

Typical Scanning Measurement Rates	Measurements Into Buffer/Computer (channel per second)
Scanning DCV or 2-wire Ω	>90 with 2000-SCAN card, >90 with 2001-TCSCAN card
Scanning Thermocouple, Thermistor, or 2-wire RTD	>85 with 2000-SCAN card, >85 with 2001-TCSCAN card
Scanning 4-wire Ω and 3- or 4-wire RTD	>80 with 2000-SCAN card, >80 with 2001-TCSCAN card
Scanning ACV	>60 with 2000-SCAN card, >60 with 2001-TCSCAN card
Scanning Alternating DCV and 2-wire Ω	>85 with 2000-SCAN card, >85 with 2001-TCSCAN card

Notes

37. Reading speeds for autozero off, fixed range, autodelay off, offset compensation off, and open lead detector off where applicable.

38. Buffer measurements: For <0.1 PLC, multisample, and single buffer transfer binary reading only.

39. Computer measurements: For 5 PLC, 1 PLC, and 0.1 PLC single reading and single transfer to computer (USB).

40. Set-up conditions of the factory default setting with the following exceptions: 3.5 digits (0.0005 PLC), autorange off, autozero off, autodelay off, and open lead detection off.

Typical Function and Range Change Speed

Function	Function Change Time ⁴²	Range Change Time ⁴³	Autorange Time ⁴²
DCV, DCI, or 2-wire Ω ⁴⁴	<4 ms	<1.3 ms	<3.2 ms
4-wire Ω ⁴⁵ or 3-wire RTD			<5.5 ms
Thermistor			—
Frequency or Period (2 ms aperture)	<1800 ms	<50 ms ⁴⁶	<50 ms ⁴⁶
ACV (300 Hz bandwidth)			
ACI (300 Hz bandwidth)			
Capacitance	<4 ms	<3 ms	<30 ms
Digitize	<4 ms	<5 ms	—
Diode	<11 ms	—	—
Continuity	<11 ms	—	—
Thermocouple	<4 ms	—	—

Bus Transfer Speed ⁴⁷

	USB	LAN	GPIB	RS232 (Baud 115200)
Average for 1000 readings (binary)	441,000	268,000	201,000	10,000
Average for 1000 readings with relative timestamp (binary)	272,000	150,000	105,000	2,900
Average for 1000 readings with formatted elements ⁴⁸	46,000	29,000	17,000	290

Typical Digitize Voltage or Current ⁴⁹

Sampling rate	Measurements over USB to computer (readings per second)
10 kS/s	Up to 10,000
50 kS/s	Up to 50,000
100 kS/s	Up to 100,000
1 MS/s up to 7 s maximum duration	At least 90,000

Triggering

Trigger Sources	Front panel trigger key, timer, command interface, LAN/LXI, Trigger In (BNC rear panel), Digital I/O (optional accessory card), and TSP-Link® (optional accessory card)
External Trigger Delay	<1 μ s when triggering from accessory card or rear BNC input
External Trigger Jitter	<1 μ s when triggering from accessory card or rear BNC input
External Trigger In/Trigger Out	0 V to 5 V logic signal input and output, TTL-compatible, programmable edge pulse Minimum pulse width: 1 μ s
External Trigger Out, Maximum Rate	Up to 90 kHz, measurement dependent
External Trigger In, Maximum Rate	Up to 150 kHz, measurement dependent

Notes

41. Assume the signal is 10 kHz or above.
42. 3.5 digits, autozero off, 0.0005 PLC, excludes measurement time.
43. DCV = 10 V; 2-wire or 4-wire = 1 k Ω ; DCI = 1 mA; ACI = 1 mA; ACV = 1 V; Capacitance = 10 μ F.
44. 2-wire function for 100 Ω range and up. For the 10 Ω range, add 2.7 ms.
45. 4-wire function for 100 Ω range and up. For the 1 Ω and 10 Ω ranges, add 2.7 ms.
46. When ranging to 10 V and above, add 1.8 s.
47. SCPI programmed using 4-byte binary format.
48. Format elements: Reading, relative timestamp, channel, and unit.
49. SCPI programmed using 4-byte binary format.

Scanning (with optional scan cards)

Scan Count	1 to continuous
Scan Interval	0 s to 27.7 hours
Channel Delay	0 to 60 s
Measure Interval	0 s to 27.7 hours

Internal Memory

Maximum Reading Memory (volatile)

Up to 7 million readings with standard buffer (includes channel and formatting information).

Internal (non-volatile) Memory for Saved Scripts and Scan Configurations

6 MB, enables hundreds of scan configurations or TSP scripts to be saved in non-volatile memory.

General Specifications

Line Power

Power Supply	100 V, 120 V, 220 V, and 240 V ($\pm 10\%$)
Power Line Frequency	50 Hz to 60 Hz and 400 Hz, automatically sensed at power-up
Maximum Power Consumption	50 VA
Typical Power Consumption	30 VA
Mains Input Fuse	250 V, 1.25 A slow-blow fuse: Keithley replacement part number FU-106-1.25

Environment and Regulatory

Operating Environment	Specified for 0° to 50°C, $\leq 80\%$ relative humidity at 35°C, altitude up to 2000 meters
Storage Environment	-40° to 70°C
Vibration	MIL-PRF-28800F Class 3, random
Warm-up	30 minutes to rated accuracy
Safety	NRTL listed to UL61010-1, and CSA C22.2 No 61010-1; conforms with European Union Low Voltage Directive
EMC	Conforms to European Union EMC Directive

Mechanical

Display	12.7 cm (5 in.) capacitive touch, color TFT WVGA (800 × 480) with LED backlight
Rack Dimensions (W × H × D)	213.8 mm (8.42 in.) × 88.4 mm (3.48 in.) × 356.6 mm (14.04 in.)
Bench Dimensions (W × H × D)	224.0 mm (8.82 in.) × 107.2 mm (4.22 in.) × 387.4 mm (15.25 in.)
Shipping Weight	4.54 kg (10.0 lb.) instrument only
Input Signal Connections	Front/rear safety banana jacks or scanner cards
Plug-in Scanner Slot	One slot on rear panel, see Optional Multi-Channel/Scanner Accessories.
Communication Slot	One slot on rear panel, see Optional Interfaces And Programmable Digital I/O.
Cooling	Forced air, fixed speed

Remote Interface – Standard

LAN/LXI Compliance	RJ-45 Connector: 10/100BT. IP Configuration: Static or DHCP (manual or automatic). Web Interface: Virtual front panel. LXI Compliance: LXI version 1.4 core 2016.
USB Device (rear panel, Type B)	2.0 full speed, USBTMC compliant
USB Host (front panel, Type A)	USB 2.0, support for flash drives, FAT32. Capability: Import/export instrument configuration files, reading buffers, screen captures, and scripts

Language

SCPI (default)	Default command set, Standard Commands for Programmable Instruments, SCPI-1999
TSP	Embedded Test Script Processor (TSP) accessible from any host interface; responds to high-speed test scripts comprised of remote commands and statements (for example, branching, looping, and math); able to execute test scripts stored in memory without host intervention
Emulation Modes	Keithley Model 2000 and 34401A

Math Functions

REL, Minimum, Maximum, Average, Standard Deviation, peak-peak, dB, Limit Test, Percent, 1/x, and mX+b with user- defined units displayed

Miscellaneous

Real-time Clock	Lithium battery backup, CR2032 coin-type, factory replaceable, (3+ years of battery life); set and read year, month, day, hour, minute, and second. (Note: Seconds are not adjustable.)
Timestamp Resolution	15 ns with standard or full buffer style
Password Protection	30 characters
Alarms	Up to six: see Optional Interfaces and Programmable Digital I/O
Power Failure Recovery Mode	User selectable, resumes scanning once power is re-applied

Optional Interfaces and Programmable Digital I/O

KTTI-GPIB	GPIB IEEE-488.1 compliant; supports IEEE-488.2 common commands and status model topology
KTTI-RS232	RS232, 9-pin d-sub female connector; standard baud rates from 300 to 115,200 bps are supported
KTTI-TSP	RJ-45 (quantity 2); TSP-Link® expansion interface allows TSP-enabled instruments to trigger and communicate with each other
Digital I/O	For KTTI-RS232, KTTI-GPIB, and KTTI-TSP Connector: 9 pin d-sub female 5 V Power Supply Pin: Limited to 500 mA > 4 V (solid-state fuse protected) Lines: Six input / output, user-defined for control, alarms (limits), or triggering Input Signal Levels: 0.7 V (maximum logic low), 3.7 V (minimum logic high) Input Voltage Limits: -0.25 V (absolute minimum), 5.25 V (absolute maximum) Maximum Source Current: 2.0 mA at > 2.7 V (per pin) Maximum Sink Current: -50 mA at 0.7 V (per pin, solid state fused)

Ordering Information

DMM6500	6½-Digit Bench/System Digital Multimeter
---------	--

Supplied Accessories

1757	Pair, General Purpose Test Lead Set, 1000 V Cat II
USB-B-1	USB Cable, Type A to Type B, 1 m (3.3 ft.)
	Traceable Calibration Certificate
	Three-Year Warranty

Instruction Manuals/Documentation (available at www.tek.com/DMM6500)

DMM6500 Quick Start Guide

DMM6500 User's Manual

DMM6500 Reference Manual

Software and Drivers (available at tek.com)

IVI/VISA Drivers for Microsoft® Visual Basic®, Visual C/C++®

National Instruments (NI®) LabView™, NMI LabWindows™/CVI (available at ni.com)

Keithley Test Script Builder available at <https://www.tek.com/keithley-test-script-builder>

KickStart available at www.tek.com/kickstart

Power Cord Options

A0	North America power plug (120 V, 60 Hz)
A1	Universal Euro power plug (220 V, 50 Hz)
A2	United Kingdom power plug (240 V, 50 Hz)
A3	Australia power plug (240 V, 50 Hz)
A4	Chile, Italy (220 V, 50 Hz)
A5	Switzerland power plug (220 V, 50 Hz)
A6	Japan power plug (100 V, 50/60 Hz)
A7	Denmark
A8	Israel
A9	Argentina
A10	China power plug (50 Hz)
A11	India power plug (50 Hz)
A12	Brazil power plug (60 Hz)
A99	No power cord

Optional Multi-Channel/Scanner Accessories

2000-SCAN Card	10 channel 2-pole or 5 channel 4-pole multiplexer
2001-TCSCAN Card	9 channel 2-pole or 4-channel 4-pole multiplexer with CJC sensor
	Limited compatibility with 2001-SCAN and 2000-SCAN-20. See the DMM6500 Firmware Release Notes for additional information.

Optional Interfaces and Programmable Digital I/O

KTTI-RS232	RS-232 Communication and Digital I/O Accessory, user-installable
KTTI-GPIB	GPIB Communication and Digital I/O Accessory, user-installable
KTTI-TSP	TSP-Link Communication and Digital I/O Accessory, user-installable

Available Accessories

Test Leads and Probes

1752	Premium Safety Test Lead Kit
1754	2-Wire Universal 10-Piece Test Lead Kit
1756	General Purpose Test Lead Kit
5804	Kelvin (4-Wire) Universal 10-Piece Test Lead Kit
5805	Kelvin (4-Wire) Spring-Loaded Probes
5806	Kelvin Clip Lead Set
5808	Low Cost Single-pin Kelvin Probe Set
8606	High Performance Modular Probe Kit
8610	Low Thermal Shorting Plug

Replacement Fuses

FU-106-1.25	Main Input Fuse, 3 A
FU-99-1	Current Input Fuse, 3 A, 250 V Fast Acting 5x20mm
159-0583-00	Current Input Fuse, 11 A, 1000 V

Cables, Connectors, Adapters

CA-18-1	Shielded Dual Banana Cable, 1.2 m (4 ft.)
---------	---

Communication Interfaces & Cables

KPCI-488LPA	IEEE-488 Interface for PCI Bus
KUSB-488B	IEEE-488 USB-to-GPIB Interface Adapter
7007-1	Shielded GPIB Cable, 1 m (3.2 ft)
7007-2	Shielded GPIB Cable, 2 m (6.5ft)
CA-180-3A	CAT5 Crossover Cable for TSP-Link / Ethernet
USB-B-1	USB Cable, Type A to Type B, 1 m (3.3 ft)

Triggering and Control

2450-TLINK	DB-9 to Trigger Link Connector Adapter
8501-1	Trigger Link Cable, DIN-to-DIN, 1 m (3.2 ft.)
8501-2	Trigger Link Cable, DIN-to-DIN, 2 m (6.5 ft.)
8503	DIN-to-BNC Trigger Cable

Rack Mount Kits

4299-8	Single Fixed Rack Mount Kit
4299-9	Dual Fixed Rack Mount Kit
4299-10	Dual Fixed Rack Mount Kit. Mount One DMM6500 and One Series 26xxB Instrument
4299-11	Dual Fixed Rack Mount Kit. Mount One DMM6500 and One Instrument from Series 2400, Series 2000, etc.

Available Services

Extended Warranties

Instruments

DMM6500-EW	3 year factory warranty extended to 4 years from date of shipment
DMM6500-5Y-EW	3 year factory warranty extended to 5 years from date of shipment

Calibration Contracts

C/DMM6500-3Y-DATA	KeithleyCare 3 Year Calibration w/Data Plan
C/DMM6500-3Y-STD	KeithleyCare 3 Year Std Calibration Plan
C/DMM6500-5Y-DATA	KeithleyCare 5 Year Calibration w/Data Plan
C/DMM6500-5Y-STD	KeithleyCare 5 Year Std Calibration Plan
C/NEW DATA	Calibration data for new units
C/NEW DATA ISO	ISO-17025 Calibration data for new units

Contact Information

Australia* 1 800 709 465
Austria 00800 2255 4835
Balkans, Israel, South Africa and other ISE Countries +41 52 675 3777
Belgium* 00800 2255 4835
Brazil +55 (11) 3759 7627
Canada 1 800 833 9200
Central East Europe/Baltics +41 52 675 3777
Central Europe/Greece +41 52 675 3777
Denmark +45 80 88 1401
Finland +41 52 675 3777
France* 00800 2255 4835
Germany* 00800 2255 4835
Hong Kong 400 820 5835
India 000 800 650 1835
Indonesia 007 803 601 5249
Italy 00800 2255 4835
Japan 81 (3) 6714 3086
Luxembourg +41 52 675 3777
Malaysia 1 800 22 55835
Mexico, Central/South America and Caribbean 52 (55) 56 04 50 90
Middle East, Asia, and North Africa +41 52 675 3777
The Netherlands* 00800 2255 4835
New Zealand 0800 800 238
Norway 800 16098
People's Republic of China 400 820 5835
Philippines 1 800 1601 0077
Poland +41 52 675 3777
Portugal 80 08 12370
Republic of Korea +82 2 6917 5000
Russia/CIS +7 (495) 6647564
Singapore 800 6011 473
South Africa +41 52 675 3777
Spain* 00800 2255 4835
Sweden* 00800 2255 4835
Switzerland* 00800 2255 4835
Taiwan 886 (2) 2656 6688
Thailand 1 800 011 931
United Kingdom/Ireland* 00800 2255 4835
USA 1 800 833 9200
Vietnam 12060128

* European toll-free number.

If not accessible, call: +41 52 675 3777

Rev. 090617



Find more valuable resources at [TEK.COM](https://www.tek.com)

Copyright © Tektronix. All rights reserved. Tektronix products are covered by U.S. and foreign patents, issued and pending. Information in this publication supersedes that in all previously published material. Specification and price change privileges reserved. TEKTRONIX and TEK are registered trademarks of Tektronix, Inc. All other trade names referenced are the service marks, trademarks or registered trademarks of their respective companies.

031618 SBG 1KW-61315-0

