



TO-92S



Pin Definition:

1. V_{CC}
2. GND
3. Output

SOT-23



Pin Definition:

1. V_{CC}
2. Output
3. GND

Description

TSH282 is an unipolar Hall effect sensor IC. It incorporates advanced chopper stabilization technology to provide accurate and stable magnetic switch points. The design, specifications and performance have been optimized for applications of solid state switches. The output transistor will be switched on (B_{OP}) in the presence of a sufficiently strong South pole magnetic field facing the marked side of the package. Similarly, the output will be switched off (B_{RP}) in the presence of a weaker South field and remain off with "0" field.

Features

- CMOS Hall IC Technology
- Solid-State Reliability
- Chopper stabilized amplifier stage
- Unipolar, output switches with absolute value of South pole from magnet
- Operation down to 3.0V
- High Sensitivity for direct reed switch replacement applications

Ordering Information

Part No.	Package	Packing
TSH282CT B0G	TO-92S	1Kpcs / Bulk Bag
TSH282CX RFG	SOT-23	3Kpcs / 7" Reel

Note: "G" denote for Halogen Free Product

Application

- Solid state switch
- Limit switch, Current limit
- Interrupter
- Current sensing
- Magnet proximity sensor for reed switch replacement

Absolute Maximum Rating (T_a = 25°C unless otherwise noted)

Characteristics	Limit	Value	Unit
Supply voltage	V _{CC}	27	V
Output Voltage	V _{OUT}	27	V
Reverse voltage	V _{CC/OUT}	-0.3	V
Magnetic flux density		Unlimited	Gauss
Output current	I _{OUT}	50	mA
Operating Temperature Range	T _{OPR}	-40 to +85	°C
Storage temperature range	T _{STG}	-55 to +150	°C
Maximum Junction Temp	T _J	150	°C
Thermal Resistance - Junction to Ambient	TO-92S	θ _{JA}	°C/W
	SOT-23		
Thermal Resistance - Junction to Case	TO-92S	θ _{JC}	°C/W
	SOT-23		
Package Power Dissipation	TO-92S	P _D	mW
	SOT-23		

Note: Exceeding the absolute maximum ratings may cause permanent damage. Exposure to absolute maximum-rated conditions for extended periods may affect device reliability.

Block Diagram

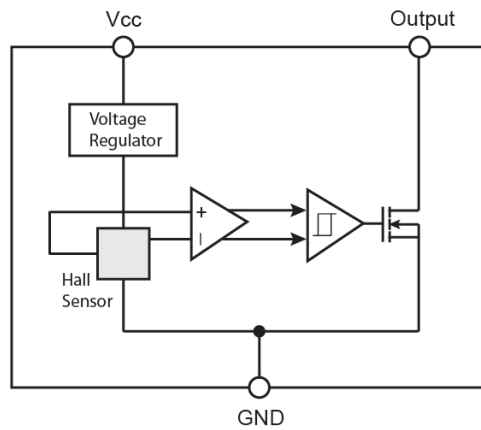

Note: Static sensitive device; please observe ESD precautions. Reverse VDD protection is not included. For reverse voltage protection, a 100Ω resistor in series with VDD is recommended.

Typical Application Circuit

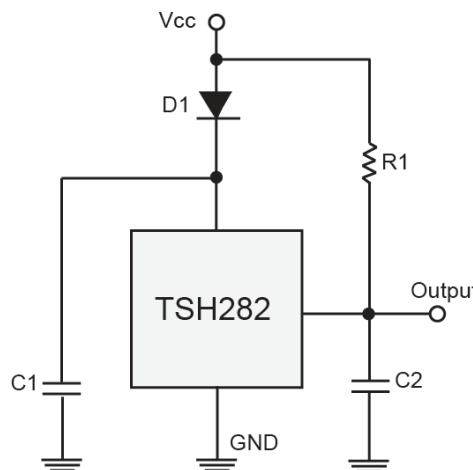

D1 : 1N4148 or 100Ω
 C1 : 1000pF
 C2 : 15pF
 R1 : 10KΩ

Electrical Specifications (DC Operating Parameters : $T_A=+25^{\circ}\text{C}$, $V_{CC}=12\text{V}$)

Parameters	Test Conditions	Min	Typ	Max	Units
Supply Voltage	Operating	3.0	--	24	V
Supply Current	$B < B_{OP}$	--	2.5	5.0	mA
Output Low Voltage	$I_{OUT} = 20\text{mA}$, $B > B_{OP}$	--	--	500	mV
Output Leakage Current	I_{OFF} $B < B_{RP}$, $V_{OUT} = 20\text{V}$	--	--	10	uA
Output Rise Time	$R_L = 1\text{k}\Omega$, $C_L = 20\text{pF}$	--	0.04	--	uS
Output Fall Time	$R_L = 1\text{k}\Omega$; $C_L = 20\text{pF}$	--	0.18	--	uS

Magnetic Specifications

DC Operating Parameters : $T_A = +25^{\circ}\text{C}$, $V_{DD} = 12\text{V}$

Parameter	Symbol	Test condition	Min	Typ	Max	Unit
Operate Point	B_{OP}		45	--	100	Gauss
Release Point	B_{RP}		25	--	70	Gauss
Hysteresis	B_{HYS}		--	20	--	Gauss

Note: 1G (Gauss) = 0.1mT (millitesla)

Output Behavior versus Magnetic Pole

DC Operating Parameters $T_a = -40$ to 125°C , $V_{DD} = 3.0 \sim 24\text{V}$

Parameter	Test condition	OUT(TO-92S)	OUT(SOT-23)
South pole	$B > B_{OP} [(100) \sim (45)]$	Low	Open (Pull-up Voltage)
Null or weak magnetic field	$-B_{RP} \sim +B_{RP}$	Open (Pull-up Voltage)	Open (Pull-up Voltage)
North pole	$B < -B_{OP} (-25 \sim -70)$	Open (Pull-up Voltage)	Low

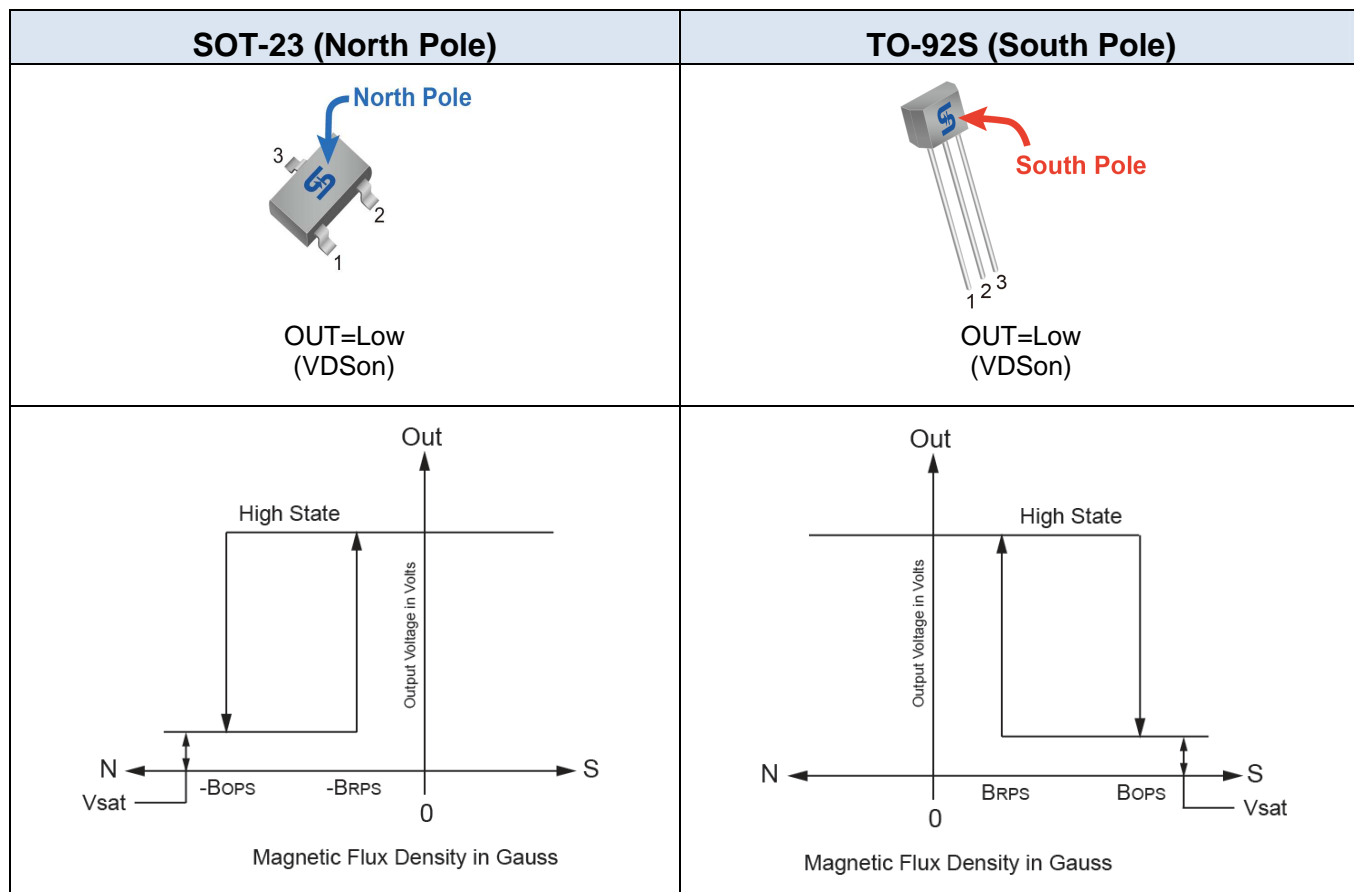

Characteristic Performance

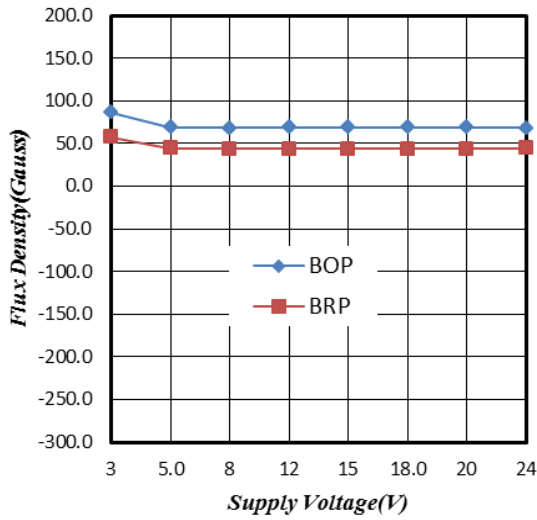

Figure 1. Supply Voltage vs. Flux Density

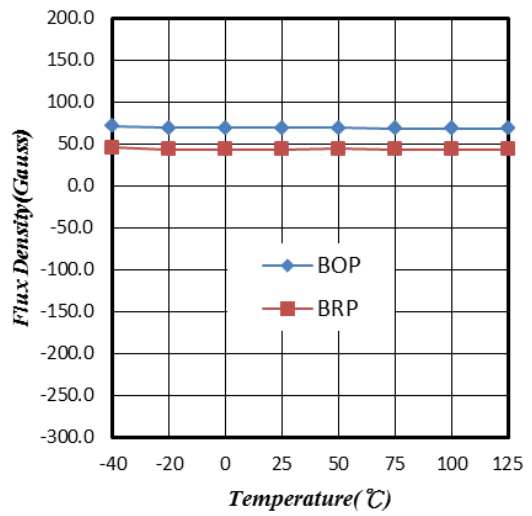

Figure 2. Temperature vs. Flux Density

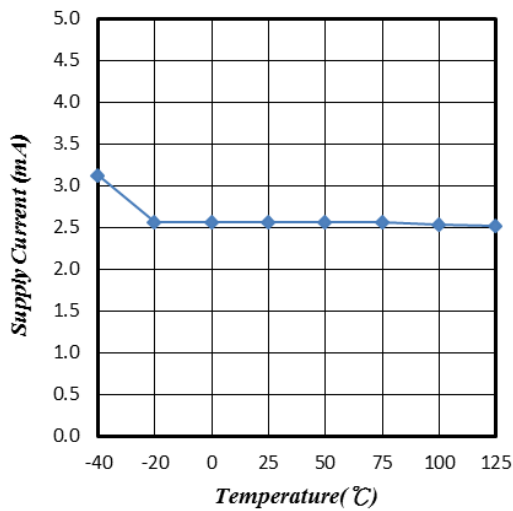

Figure 3. Supply Current vs. Temperature

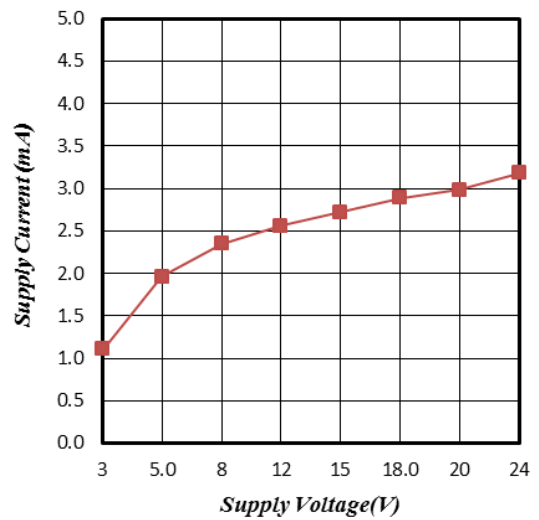

Figure 4. Supply Current vs. Supply Voltage

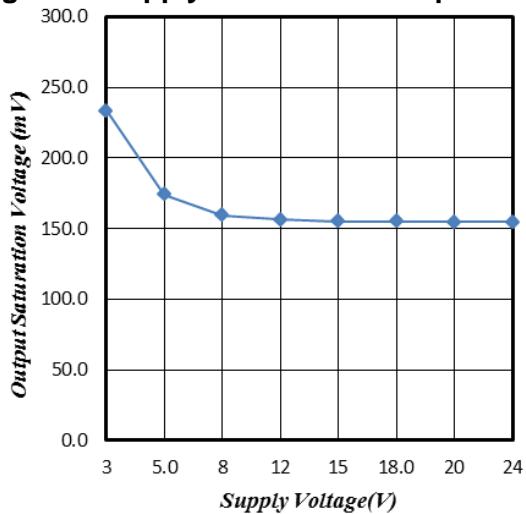

Figure 5. Output Saturation Voltage vs. Supply Voltage

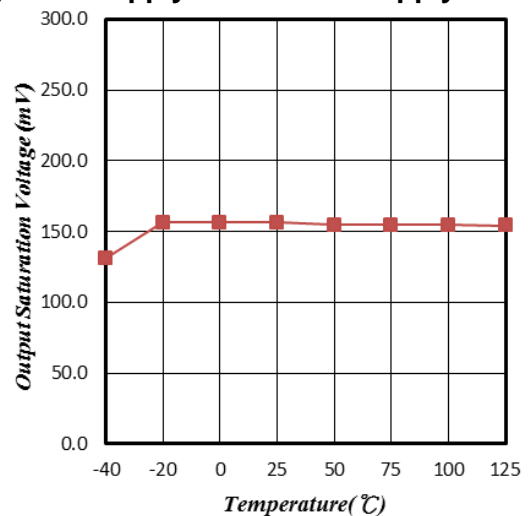

Figure 6. Output Saturation Voltage vs. Temperature

Characteristic Performance

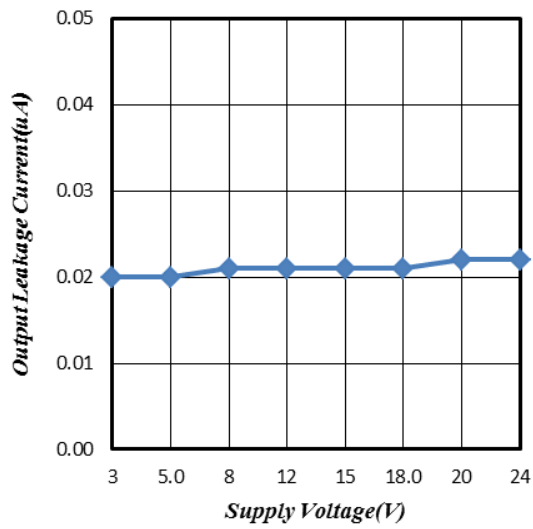

Figure 7. Output Leakage Current vs. Supply Voltage

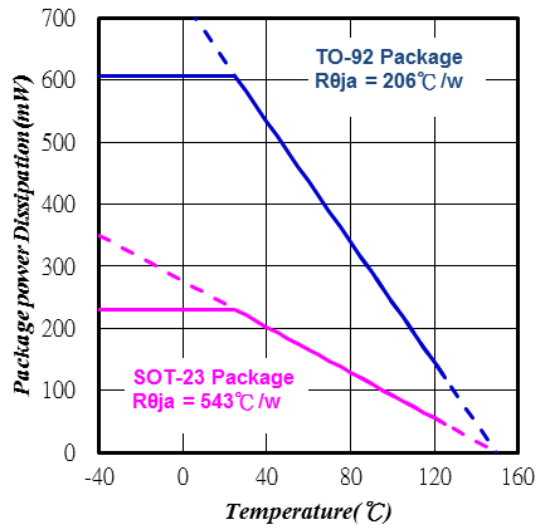

Figure 8. Power Dissipation vs. Temperature

TO-92S Mechanical Drawing



Unit: Millimeters

Marking Diagram

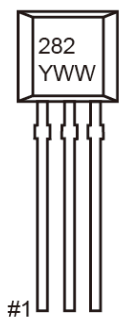

- 282** = Device Code
- Y** = Year Code (3=2013, 4=2014....)
- WW** = Week Code (01~52)

SOT-23 Mechanical Drawing

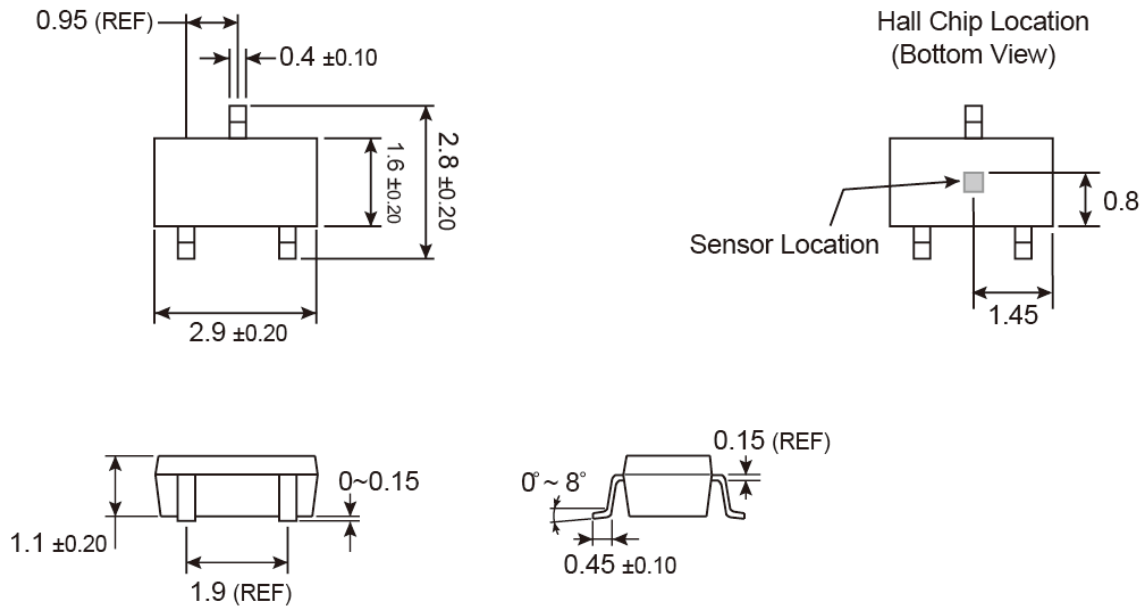

Unit: Millimeters

Marking Diagram

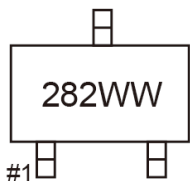

282 = Device Code
WW = Week Code Table

week	1	2	3	4	5	6	7	8	9	10	11	12	13
code	OA	OB	OC	OD	OE	OF	OG	OH	OI	OJ	OK	OL	OM
week	14	15	16	17	18	19	20	21	22	23	24	25	26
code	ON	OO	OP	OQ	OR	OS	OT	OU	OV	OW	OX	OY	OZ
week	27	28	29	30	31	32	33	34	35	36	37	38	39
code	PA	PB	PC	PD	PE	PF	PG	PH	PI	PJ	PK	PL	PM
week	40	41	42	43	44	45	46	47	48	49	50	51	52
code	PN	PO	PP	PQ	PR	PS	PT	PU	PV	PW	PX	PY	PZ

Notice

Specifications of the products displayed herein are subject to change without notice. TSC or anyone on its behalf, assumes no responsibility or liability for any errors or inaccuracies.

Information contained herein is intended to provide a product description only. No license, express or implied, to any intellectual property rights is granted by this document. Except as provided in TSC's terms and conditions of sale for such products, TSC assumes no liability whatsoever, and disclaims any express or implied warranty, relating to sale and/or use of TSC products including liability or warranties relating to fitness for a particular purpose, merchantability, or infringement of any patent, copyright, or other intellectual property right.

The products shown herein are not designed for use in medical, life-saving, or life-sustaining applications. Customers using or selling these products for use in such applications do so at their own risk and agree to fully indemnify TSC for any damages resulting from such improper use or sale.