



# Photointerrupter Product Data Sheet

LTH-209-01

Spec No.: DS-55-92-0007

Effective Date: 06/15/2000

Revision: -

**LITE-ON DCC**

**RELEASE**

BNS-OD-FC001/A4

# LITEON LITE-ON TECHNOLOGY CORPORATION

Property of LITON Only

## FEATURES

- \* NON-CONTACT SWITCHING.
- \* FOR DIRECT PC BOARD OR DUAL-IN-LINE SOCKET MOUNTING.
- \* FAST SWITCHING SPEED.
- \* REFLECTIVE OBJECT SENSOR.

## PACKAGE DIMENSIONS

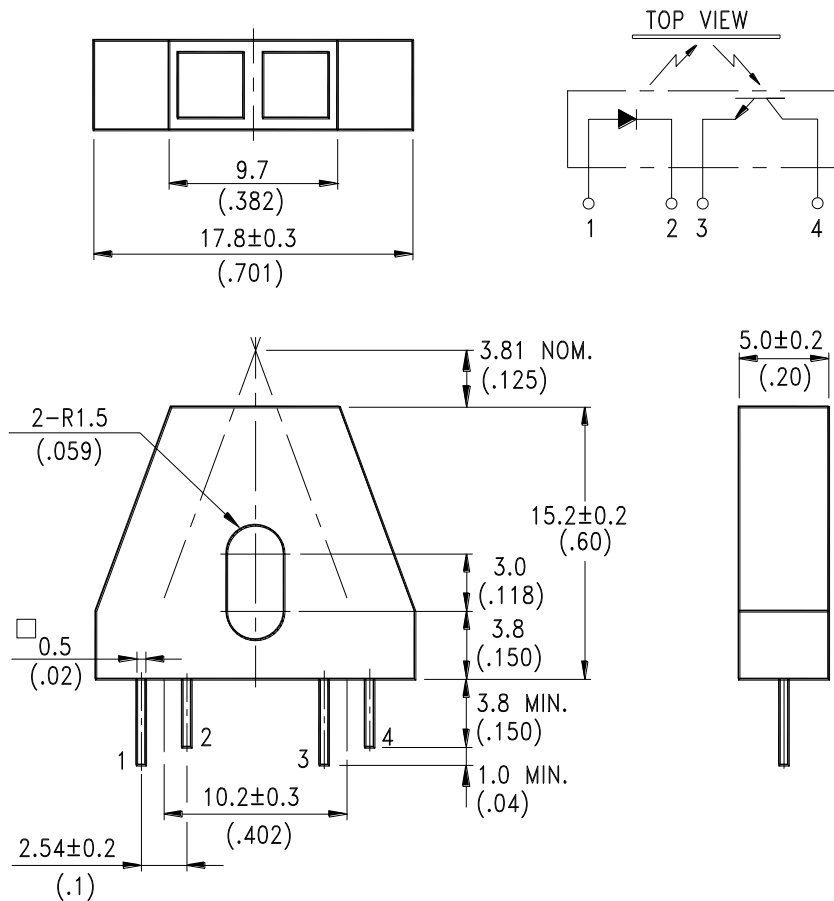

## NOTES:

1. All dimensions are in millimeters (inches).
2. Tolerance is  $\pm 0.25$ mm ( $.010$ " ) unless otherwise noted.
3. Specification are subject to change without notice.

## ABSOLUTE MAXIMUM RATINGS AT TA=25°C

PARAMETER	MAXIMUM RATING	UNIT
IR Diode Continuous Forward Current	50	mA
IR Diode Reverse Voltage	5	V
Transistor Collector Current	20	mA
Transistor Power Dissipation	100	mW (Note 1)
IR Diode Peak Power Current (Pulse Wide = 10 $\mu$ S, 300 pps)	3	A
Diode Power Dissipation	75	mW (Note 1)
Phototransistor Collector-Emitter Voltage	30	V
Phototransistor Emitter-Collector Voltage	5	V
Operating Temperature Range	-35°C to + 65°C	
Storage Temperature Range	-40°C to + 100°C	
Lead Soldering Temperature [1.6mm(.063") From Case]	260°C for 5 Seconds	

Note 1: Derate Linearly 1.33 mW /°C from 25°C

# LITEON LITE-ON TECHNOLOGY CORPORATION

Property of LITON Only

## ELECTRICAL OPTICAL CHARACTERISTICS AT TA=25°C

PARAMETER	SYMBOL	MIN.	TYP.	MAX.	UNIT	TEST CONDITION
<b>INPUT LED</b>						
Forward Voltage	VF		1.2	1.6	V	IF = 20mA
Reverse Current	IR			100	μA	VR=5V
<b>OUTPUT PHOTOTRANSISTOR</b>						
Collector-Emitter Breakdown Voltage	V(BR)CEO	30			V	IC=1mA
Emitter-Collector Breakdown Voltage	V(BR)ECO	5			V	IE=0.1mA
Collector-Emitter Dark Current	ICEO			100	nA	VCE=10V
<b>COUPLER</b>						
Collector-Emitter Saturation Voltage	VCE(SAT)			0.4	V	IC=0.08mA IF=20mA
On State Collector Current (Note 1)	Ic(ON)	0.16			mA	VCE=5V IF=20mA

Note 1: Reflective surface is Eastman Kodak (or Equivalent) neutral white paper with 90% diffused reflectance placed 3.81 mm (0.15 inch) from read head.

## TYPICAL ELECTRICAL / OPTICAL CHARACTERISTICS CURVES

(25°C Ambient Temperature Unless Otherwise Noted)

Fig.1 Power Dissipation vs. Ambient Temperature

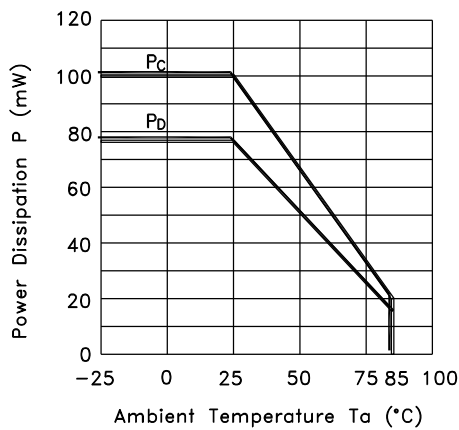

Fig.2 Forward Current vs. Forward Voltage

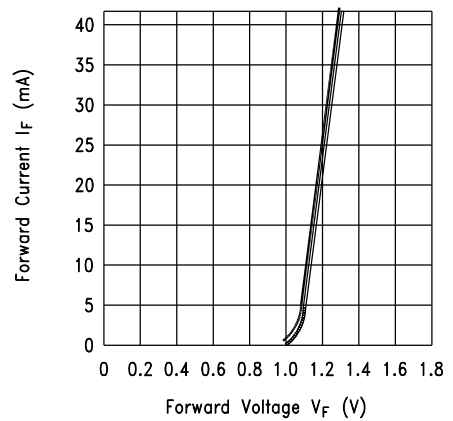

Fig.3 Collector Current vs. Collector-emitter Voltage

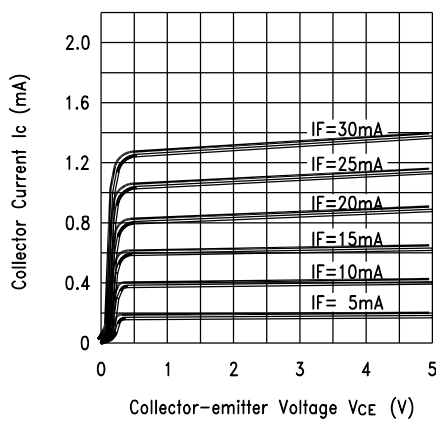
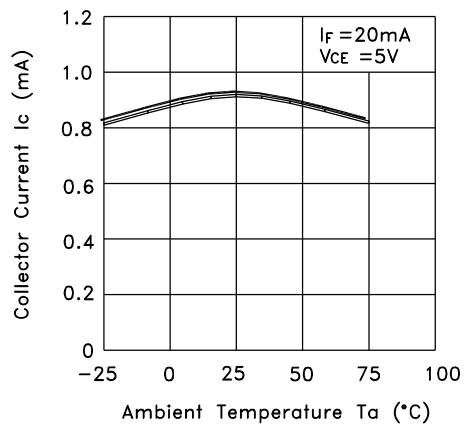

Fig.4 Collector Current vs. Ambient Temperature



## TYPICAL ELECTRICAL / OPTICAL CHARACTERISTICS CURVES

(25°C Ambient Temperature Unless Otherwise Noted)

Fig.5 Collector-emitter Saturation vs. Voltage Ambient Temperature

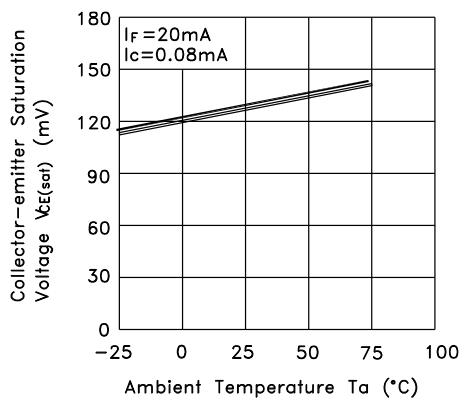

Fig.6 Relative Collector Current vs. Object Distance

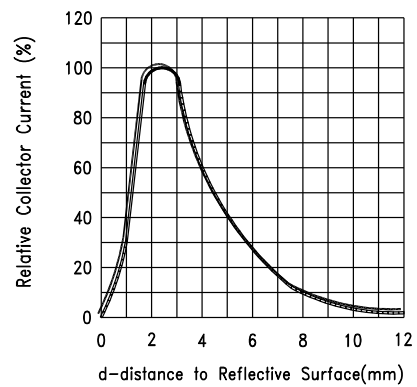
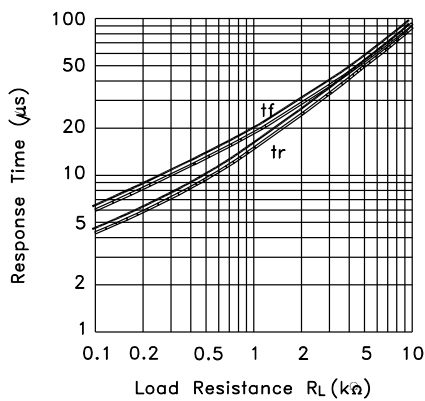
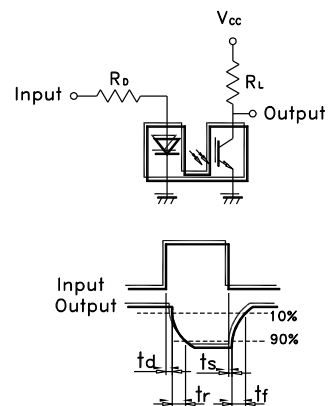

Fig.7 Response Time vs. Load Resistance



Test Circuit for Response Time



# Mouser Electronics

Authorized Distributor

Click to View Pricing, Inventory, Delivery & Lifecycle Information:

[Lite-On:](#)

[LTH-209-01](#)