

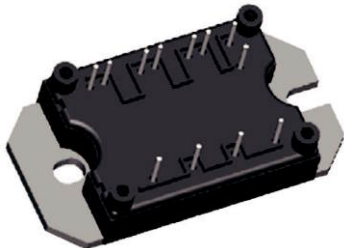

"Half Bridge" IGBT MTP (Warp Speed IGBT), 114 A

MTP

FEATURES

- Generation 4 warp speed IGBT technology
- HEXFRED® antiparallel diodes with ultrasoft reverse recovery
- Very low conduction and switching losses
- Optional SMD thermistor (NTC)
- Very low junction to case thermal resistance
- UL approved file E78996 
- Speed 60 kHz to 100 kHz
- Compliant to RoHS directive 2002/95/EC
- Designed and qualified for industrial level

RoHS
COMPLIANT

PRODUCT SUMMARY	
V_{CES}	600 V
$V_{CE(on)}$ typical at $V_{GE} = 15$ V	2.3 V
I_C at $T_C = 25$ °C	114 A

BENEFITS

- Optimized for welding, UPS and SMPS applications
- Low EMI, requires less snubbing
- Direct mounting to heatsink
- PCB solderable terminals
- Very low stray inductance design for high speed operation

ABSOLUTE MAXIMUM RATINGS				
PARAMETER	SYMBOL	TEST CONDITIONS	MAX.	UNITS
Collector to emitter voltage	V_{CES}		600	V
Continuous collector current	I_C	$T_C = 25$ °C	114	A
		$T_C = 109$ °C	50	
Pulsed collector current	I_{CM}		350	
Peak switching current	I_{LM}		350	
Diode continuous forward current	I_F	$T_C = 109$ °C	34	
Peak diode forward current	I_{FM}		200	
Gate to emitter voltage	V_{GE}		± 20	V
RMS isolation voltage	V_{ISOL}	Any terminal to case, t = 1 minute	2500	
Maximum power dissipation	P_D	$T_C = 25$ °C	658	W
		$T_C = 100$ °C	263	

ELECTRICAL SPECIFICATIONS ($T_J = 25\text{ }^\circ\text{C}$ unless otherwise specified)						
PARAMETER	SYMBOL	TEST CONDITIONS	MIN.	TYP.	MAX.	UNITS
Collector to emitter breakdown voltage	$V_{(BR)CES}$	$V_{GE} = 0\text{ V}$, $I_C = 500\text{ }\mu\text{A}$	600	-	-	V
Collector to emitter voltage	$V_{CE(on)}$	$V_{GE} = 15\text{ V}$, $I_C = 50\text{ A}$	-	2.3	3.15	V
		$V_{GE} = 15\text{ V}$, $I_C = 100\text{ A}$	-	2.5	3.2	
		$V_{GE} = 15\text{ V}$, $I_C = 50\text{ A}$, $T_J = 150\text{ }^\circ\text{C}$	-	1.72	2.17	
Gate threshold voltage	$V_{GE(th)}$	$I_C = 0.5\text{ mA}$	3	-	6	
Collector to emitter leaking current	I_{CES}	$V_{GE} = 0\text{ V}$, $I_C = 600\text{ A}$	-	-	0.4	mA
		$V_{GE} = 0\text{ V}$, $I_C = 600\text{ A}$, $T_J = 150\text{ }^\circ\text{C}$	-	-	10	
Diode forward voltage drop	V_{FM}	$I_F = 50\text{ A}$, $V_{GE} = 0\text{ V}$	-	1.58	1.80	V
		$I_F = 50\text{ A}$, $V_{GE} = 0\text{ V}$, $T_J = 150\text{ }^\circ\text{C}$	-	1.49	1.68	
		$I_F = 100\text{ A}$, $V_{GE} = 0\text{ V}$, $T_J = 25\text{ }^\circ\text{C}$	-	1.9	2.17	
Gate to emitter leakage current	I_{GES}	$V_{GE} = \pm 20\text{ V}$	-	-	± 250	nA

SWITCHING CHARACTERISTICS ($T_J = 25\text{ }^\circ\text{C}$ unless otherwise specified)						
PARAMETER	SYMBOL	TEST CONDITIONS	MIN.	TYP.	MAX.	UNITS
Total gate charge (turn-on)	Q_g	$I_C = 52\text{ A}$ $V_{CC} = 400\text{ V}$ $V_{GE} = 15\text{ V}$	-	331	385	nC
Gate to emitter charge (turn-on)	Q_{ge}		-	44	52	
Gate to collector charge (turn-on)	Q_{gc}		-	133	176	
Turn-on switching loss	E_{on}	Internal gate resistors (see electrical diagram) $I_C = 50\text{ A}$, $V_{CC} = 480\text{ V}$, $V_{GE} = 15\text{ V}$, $L = 200\text{ }\mu\text{H}$ Energy losses include tail and diode reverse recovery, $T_J = 25\text{ }^\circ\text{C}$	-	0.26	-	mJ
Turn-off switching loss	E_{off}		-	1.2	-	
Total switching loss	E_{ts}		-	1.46	-	
Turn-on switching loss	E_{on}	Internal gate resistors (see electrical diagram) $I_C = 50\text{ A}$, $V_{CC} = 480\text{ V}$, $V_{GE} = 15\text{ V}$, $L = 200\text{ }\mu\text{H}$ Energy losses include tail and diode reverse recovery, $T_J = 150\text{ }^\circ\text{C}$	-	0.73	-	mJ
Turn-off switching loss	E_{off}		-	1.66	-	
Total switching loss	E_{ts}		-	2.39	-	
Input capacitance	C_{ies}	$V_{GE} = 0\text{ V}$ $V_{CC} = 30\text{ V}$ $f = 1.0\text{ MHz}$	-	7100	-	pF
Output capacitance	C_{oes}		-	510	-	
Reverse transfer capacitance	C_{res}		-	140	-	
Diode reverse recovery time	t_{rr}	$V_{CC} = 200\text{ V}$, $I_C = 50\text{ A}$ $dI/dt = 200\text{ A}/\mu\text{s}$	-	82	97	ns
Diode peak reverse current	I_{rr}		-	8.3	10.6	A
Diode recovery charge	Q_{rr}		-	340	514	nC
Diode reverse recovery time	t_{rr}	$V_{CC} = 200\text{ V}$, $I_C = 50\text{ A}$ $dI/dt = 200\text{ A}/\mu\text{s}$ $T_J = 125\text{ }^\circ\text{C}$	-	137	153	ns
Diode peak reverse current	I_{rr}		-	12.7	14.8	A
Diode recovery charge	Q_{rr}		-	870	1132	nC



THERMISTOR SPECIFICATIONS						
PARAMETER	SYMBOL	TEST CONDITIONS	MIN.	TYP.	MAX.	UNITS
Resistance	R_0 ⁽¹⁾	$T_0 = 25\text{ }^\circ\text{C}$	-	30	-	k Ω
Sensitivity index of the thermistor material	β ⁽¹⁾⁽²⁾	$T_0 = 25\text{ }^\circ\text{C}$ $T_1 = 85\text{ }^\circ\text{C}$	-	4000	-	K

Notes

⁽¹⁾ T_0, T_1 are thermistor's temperatures

⁽²⁾ $\frac{R_0}{R_1} = \exp\left[\beta\left(\frac{1}{T_0} - \frac{1}{T_1}\right)\right]$, temperature in Kelvin

THERMAL AND MECHANICAL SPECIFICATIONS						
PARAMETER	SYMBOL	TEST CONDITIONS	MIN.	TYP.	MAX.	UNITS
Operating junction temperature range	IGBT, Diode		- 40	-	150	$^\circ\text{C}$
	Thermistor		- 40	-	125	
Storage temperature range	T_{Stg}		- 40	-	125	
Junction to case	IGBT		-	-	0.38	$^\circ\text{C/W}$
	Diode		-	-	0.8	
Case to sink per module	R_{thCS}	Heatsink compound thermal conductivity = 1 W/mK	-	0.06	-	
Clearance ⁽¹⁾		External shortest distance in air between 2 terminals	5.5	-	-	mm
Creepage ⁽¹⁾		Shortest distance along the external surface of the insulating material between 2 terminals	8	-	-	mm
Mounting torque to heatsink		A mounting compound is recommended and the torque should be checked after 3 hours to allow for the spread of the compound. Lubricated threads.	3 \pm 10 %			Nm
Weight			66			g

Note

⁽¹⁾ Standard version only i.e. without optional thermistor

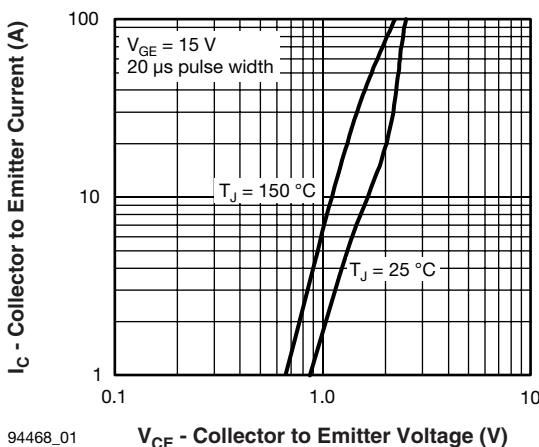

Fig. 1 - Typical Output Characteristics

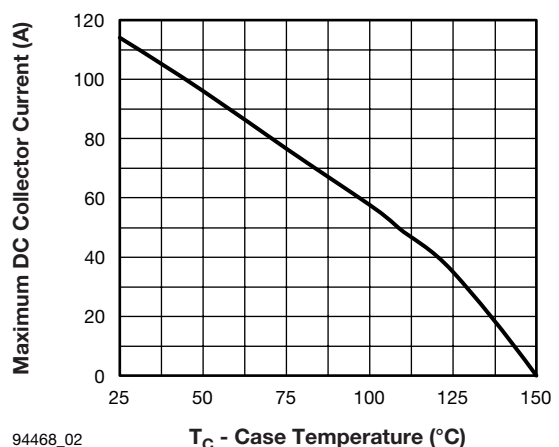

Fig. 2 - Maximum Collector Current vs. Case Temperature

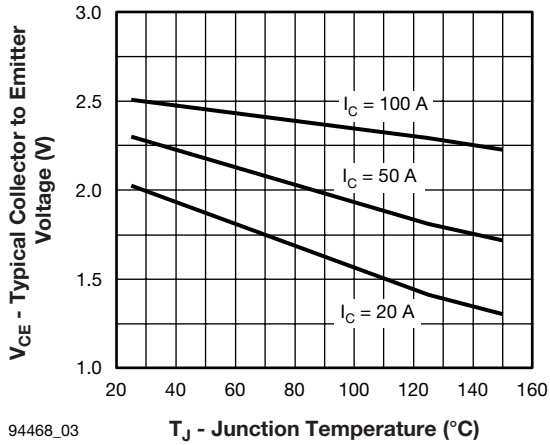

Fig. 3 - Typical Collector to Emitter Voltage vs. Junction Temperature

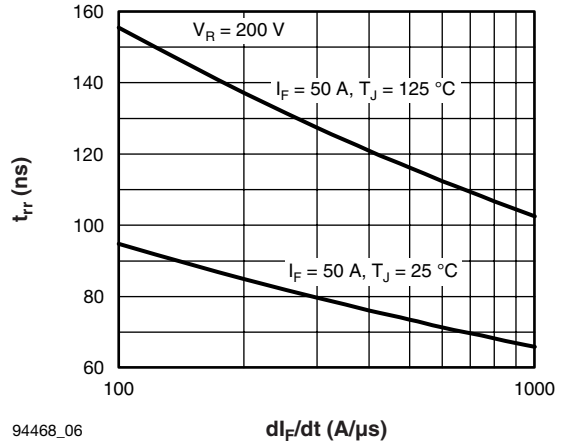

Fig. 6 - Typical Reverse Recovery Time vs. di_F/dt

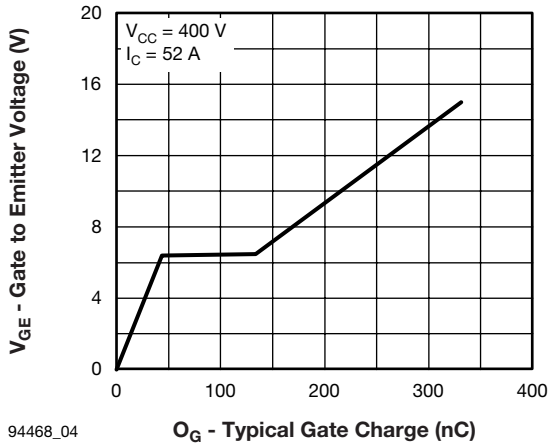

Fig. 4 - Typical Gate Charge vs. Gate to Emitter Voltage

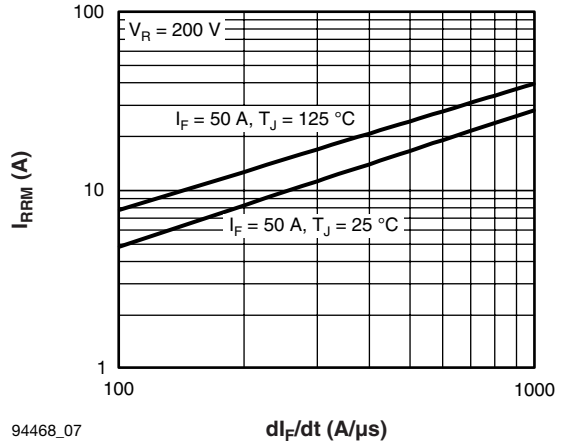

Fig. 7 - Typical Reverse Recovery Current vs. di_F/dt

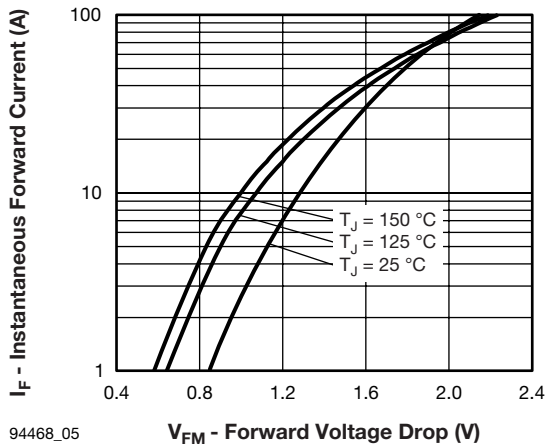

Fig. 5 - Maximum Forward Voltage Drop vs. Instantaneous Forward Current

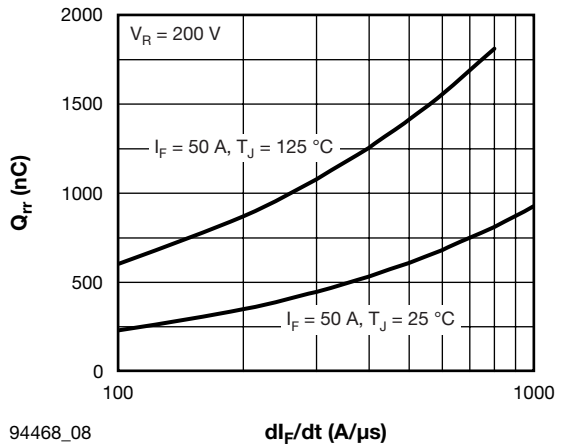

Fig. 8 - Typical Stored Charge vs. di_F/dt

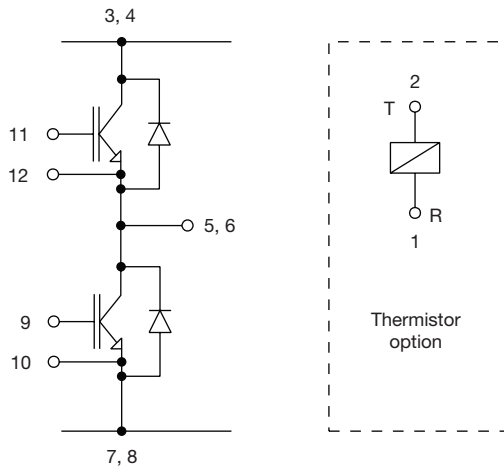

Fig. 9 - Functional Diagram

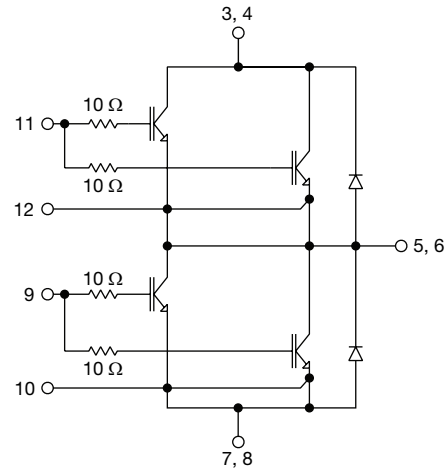
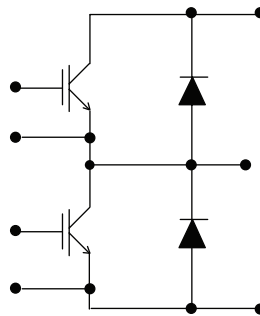

Fig. 10 - Electrical Diagram

ORDERING INFORMATION TABLE

Device code	50	MT	060	W	H	T	A	PbF	
	①	②	③	④	⑤	⑥	⑦	⑧	
	1	-	Current rating (50 = 50 A)	2	-	Essential part number	3	-	Voltage rating (060 = 600 V)
	4	-	Speed/type (W = Warp IGBT)	5	-	Circuit configuration (H = Half bridge)	6	-	T = Thermistor
	7	-	A = Al ₂ O ₃ substrate	8	-	Lead (Pb)-free			

CIRCUIT CONFIGURATION



LINKS TO RELATED DOCUMENTS	
Dimensions	www.vishay.com/doc?95175

MTP

DIMENSIONS in millimeters

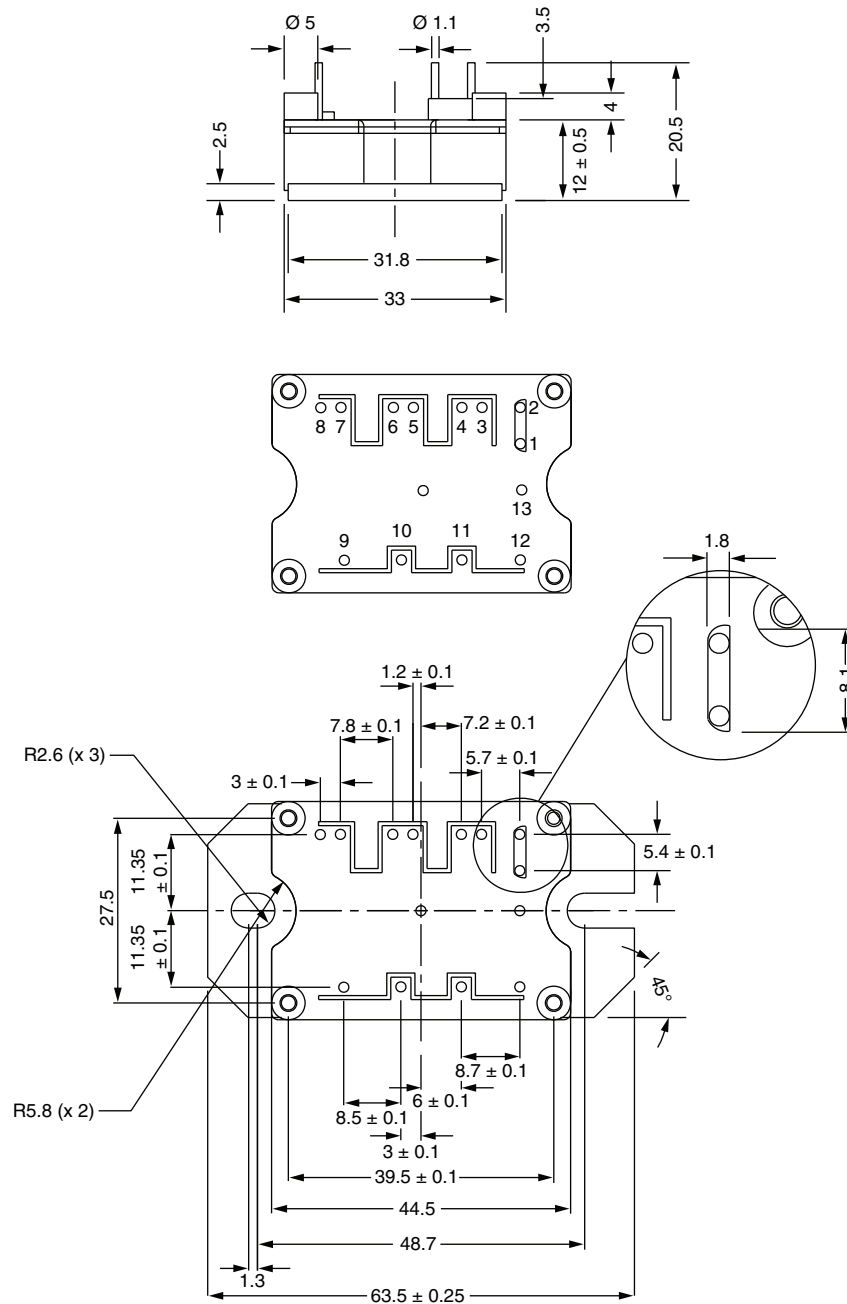

Note

- Unused terminals are not assembled in the package



Disclaimer

ALL PRODUCT, PRODUCT SPECIFICATIONS AND DATA ARE SUBJECT TO CHANGE WITHOUT NOTICE TO IMPROVE RELIABILITY, FUNCTION OR DESIGN OR OTHERWISE.

Vishay Intertechnology, Inc., its affiliates, agents, and employees, and all persons acting on its or their behalf (collectively, "Vishay"), disclaim any and all liability for any errors, inaccuracies or incompleteness contained in any datasheet or in any other disclosure relating to any product.

Vishay makes no warranty, representation or guarantee regarding the suitability of the products for any particular purpose or the continuing production of any product. To the maximum extent permitted by applicable law, Vishay disclaims (i) any and all liability arising out of the application or use of any product, (ii) any and all liability, including without limitation special, consequential or incidental damages, and (iii) any and all implied warranties, including warranties of fitness for particular purpose, non-infringement and merchantability.

Statements regarding the suitability of products for certain types of applications are based on Vishay's knowledge of typical requirements that are often placed on Vishay products in generic applications. Such statements are not binding statements about the suitability of products for a particular application. It is the customer's responsibility to validate that a particular product with the properties described in the product specification is suitable for use in a particular application. Parameters provided in datasheets and/or specifications may vary in different applications and performance may vary over time. All operating parameters, including typical parameters, must be validated for each customer application by the customer's technical experts. Product specifications do not expand or otherwise modify Vishay's terms and conditions of purchase, including but not limited to the warranty expressed therein.

Except as expressly indicated in writing, Vishay products are not designed for use in medical, life-saving, or life-sustaining applications or for any other application in which the failure of the Vishay product could result in personal injury or death. Customers using or selling Vishay products not expressly indicated for use in such applications do so at their own risk and agree to fully indemnify and hold Vishay and its distributors harmless from and against any and all claims, liabilities, expenses and damages arising or resulting in connection with such use or sale, including attorneys fees, even if such claim alleges that Vishay or its distributor was negligent regarding the design or manufacture of the part. Please contact authorized Vishay personnel to obtain written terms and conditions regarding products designed for such applications.

No license, express or implied, by estoppel or otherwise, to any intellectual property rights is granted by this document or by any conduct of Vishay. Product names and markings noted herein may be trademarks of their respective owners.

Material Category Policy

Vishay Intertechnology, Inc. hereby certifies that all its products that are identified as RoHS-Compliant fulfill the definitions and restrictions defined under Directive 2011/65/EU of The European Parliament and of the Council of June 8, 2011 on the restriction of the use of certain hazardous substances in electrical and electronic equipment (EEE) - recast, unless otherwise specified as non-compliant.

Please note that some Vishay documentation may still make reference to RoHS Directive 2002/95/EC. We confirm that all the products identified as being compliant to Directive 2002/95/EC conform to Directive 2011/65/EU.