

AVX RF Microwave Products



Version 16.4

AVX
A KYOCERA GROUP COMPANY

*AVX Microwave
Ask The World Of Us*

As one of the world's broadest line multilayer ceramic chip capacitor suppliers, and a major Thin Film RF/Microwave capacitor, inductor, directional coupler and low pass filter and microwave ceramic capacitor manufacturer, it is our mission to provide **First In Class** Technology, Quality and Service, by establishing progressive design, manufacturing and continuous improvement programs driving toward a single goal:

TOTAL CUSTOMER SATISFACTION

QV2000

Table of Contents

| | |
|------------------------------|----------|
| Company Profile | 4 |
|------------------------------|----------|

Thin-Film RF/Microwave Capacitor Technology

Accu-P®

| | |
|--|--------------|
| Thin-Film Technology..... | 6 |
| Thin-Film Chip Capacitors | 7-9 |
| 0201 Typical Electrical Tables – Accu-P® | 10-11 |
| 0402 Typical Electrical Tables – Accu-P® | 12-13 |
| 0603 Typical Electrical Tables – Accu-P® | 14-15 |
| 0805 Typical Electrical Tables – Accu-P® | 16-17 |
| 1210 Typical Electrical Tables – Accu-P® | 18-19 |
| High Frequency Characteristics | 20-25 |
| Environmental / Mechanical Characteristics | 26 |
| Performance Characteristics RF Power Applications..... | 27 |
| Application Notes..... | 28-29 |
| Automatic Insertion Packaging | 30 |

Thin-Film RF/Microwave Inductor Technology

Accu-L®

| | |
|--|--------------|
| L0201 Tight Tolerance RF Inductor | 32-33 |
| L0402 Tight Tolerance RF Inductor | 34-35 |
| L0603 AND L0805 SMD High-Q RF Inductor – Accu-L® | 36-38 |
| Environmental Characteristics..... | 39 |
| Application Notes | 40 |

Thin-Film RF/Microwave Directional Couplers

CP0302/CP0402/CP0603/CP0805 and DB0603N/DB0805 3dB 90°

| | |
|---|--------------|
| CP0402W2700FNTR Wide Band High Directivity | 42-43 |
| CP0402W2700FNTR Test Jigs | 44 |
| CP0302A5425ENTR / CP0402Q5425ENTR / CP0603Q5425ENTR High Directivity Directional Couplers For WiFi Bands | 45-46 |
| CP0402P High Directivity, Tight Coupling Tolerance | 47-48 |
| CP0402 High Directivity LGA Termination..... | 49-52 |
| CP0603 High Directivity LGA Termination..... | 53-58 |
| CP0402 / CP0603 High Directivity Couplers Test Jigs..... | 59 |
| CP0603 SMD Type – Thin-Film Directional Couplers..... | 60-62 |
| CP0603 SMD Type – High Directivity | 63 |
| CP0805 SMD Type – Thin-Film Directional Couplers..... | 64-68 |
| CP0805 and CP0603 Test Jigs | 69 |
| DB0603N 3dB 90° Couplers | 70-86 |
| DB0805 3dB 90° Couplers | 87-98 |
| DB0805 3dB 90° Test Jigs | 99 |

Thin-Film RF/Microwave Harmonic Low Pass Filter

LP0402/LP0603/LP0805

| | |
|--|----------------|
| LP0402N Series Harmonic Low Pass Filter Lead-Free LGA Termination..... | 101-103 |
| LP0402N Series Harmonic Low Pass Filter Lead-Free LGA Termination Test Jigs | 104 |
| LP0603 Lead-Free LGA Type | 105-108 |
| LP0603 Test Jigs | 109 |
| LP0805 Type Harmonic..... | 110-111 |
| LP0805 Test Jigs..... | 112 |

1206 High Performance

| | |
|---|----------------|
| LP1206A0512BNTR Harmonic Low Pass Filter..... | 113-114 |
| LP1206A0700ANTR Low Pass Filter..... | 115-116 |

Thin-Film RF/Microwave Products – Designer Kits

Multilayer Organic (MLO™) Technology

MLO™ Capacitors

MLO™ Diplexers

| | |
|--|----------------|
| 0603 WLAN/BT | 125-130 |
| 0805 CDMA | 131-132 |
| 0805 WCDMA | 133-134 |
| 0805 WLAN | 135-136 |
| 0805 WLAN/BT | 137-138 |
| Automated SMT Assembly/SMT Reflow Profile..... | 139 |

MLO™ Inductors

| | |
|--|----------------|
| Tight Tolerance | 140-141 |
| High Current..... | 142-143 |
| Hi-Q..... | 144-145 |
| Performance Characteristics..... | 146 |
| Automated SMT Assembly/SMT Reflow Profile..... | 147 |

MLO™ SMT Crossovers

| | |
|--|----------------|
| RF-DC..... | 148-150 |
| RF-RF | 151-153 |
| Automated SMT Assembly/SMT Reflow Profile..... | 154 |

RF Inductors

| | |
|--|----------------|
| AL Series – Air Core Inductors..... | 156-162 |
| AS Series – Square Air Core Inductors..... | 163-167 |
| LCWC Series – Wire Wound Chip Inductor | 168-177 |

RF/Microwave Capacitors

RF/Microwave Multilayer Capacitors (MLC)

| | |
|--|----------------|
| UQ Series High Q Ultra Low ESR MLC | 179-191 |
| SQ Series Ultra Low ESR MLC | 192-204 |
| MK Series Ultra Low ESR, COG (NPO) Capacitors | 205-207 |
| AQ Series | 208-211 |
| MIL-PRF-55681 “BG” Voltage Temperature Limits (+90±20ppm/°C)..... | 212-214 |
| • CDR11BG; CDR12BG (0.055" x 0.055") - Failure Rate Level: M, P, R, S • CDR13BG; CDR14BG (0.110" x 0.110") - Failure Rate Level: M, P, R, S | |
| Performance Curves | 215-219 |
| Automatic Insertion Packaging | 220 |
| HQ® Series, High RF Power Capacitors..... | 221-227 |

RF/Microwave COG (NPO) Capacitors

| | |
|--|----------------|
| Ultra Low ESR “CU” Series, COG (NPO) Capacitors (RoHS) | 228-229 |
| Ultra Low ESR “U” Series, COG (NPO) Capacitors (RoHS)..... | 230-232 |
| Ultra Low ESR “U” Series, COG (NPO) Capacitors (RoHS) Automotive, AEC Q200 Qualified..... | 233-235 |
| Ultra Low ESR “U” Series, COG (NPO) Capacitors (Sn/Pb)..... | 236-238 |

RF/Microwave “U” Series Designer Kits

Table of Contents

| | | |
|--|---------------------------------|----------|
| Company Profile | 4 | |
| Thin-Film RF/Microwave Capacitor Technology | 5-30 | 1 |
| Accu-P | | |
| Thin-Film RF/Microwave Inductor Technology | 31-40 | 2 |
| Accu-L [®] | | |
| Thin-Film RF/Microwave Directional Couplers | 41-99 | 3 |
| CP0302/CP0402/CP0603/CP0805 and DB0603N/DB0805 3dB 90° | | |
| Thin-Film RF/Microwave Harmonic Low Pass Filter | 100-116 | 4 |
| LP0402/LP0603/LP0805 | | |
| LP1206 High Performance | | |
| Thin-Film RF/Microwave Products – Designer Kits | 117-119 | 5 |
| Multilayer Organic (MLO[™]) Technology | 120-154 | 6 |
| MLO [™] Capacitors | MLO [™] Inductors | |
| MLO [™] Diplexers | MLO [™] SMT Crossovers | |
| RF Inductors | 155-177 | 7 |
| Air Core Inductors | | |
| Square Air Core Inductors | | |
| Wire Wound Chip Inductors | | |
| RF/Microwave Capacitors | 178-239 | 8 |
| RF/Microwave Multilayer Capacitors (MLC) | | |
| RF/Microwave COG (NPO) Capacitors | | |
| RF/Microwave “U” Series Designer Kits | | |

AVX Corporation is a leading manufacturer of multilayer ceramic, thin film and tantalum, as well as other passive electronic components. These products are used in virtually every electronic system today, including data processing, telecommunications, consumer electronics, automotive electronics, military and aerospace systems, and instrumentation and process controls.

We continually strive to be the leader in all component segments we supply. RF/Microwave capacitors is a thrust business for us. AVX offers a broad line of RF/Microwave Chip Capacitors in a wide range of sizes, styles, and ratings.

The Thin-Film Products range illustrated in this catalog represents the state-of-the-art in RF Capacitors, Inductors, Directional Couplers and Low Pass Filters. The thin-film technology provides components that exhibit excellent batch-to-batch repeatability of electrical parameters at RF frequencies.

The Accu-P® series of capacitors are available in ultra-tight tolerances ($\pm 0.01\text{pF}$) as well as non-standard capacitance values.

The Accu-L® series of inductors are ideally suited for applications requiring an extremely high Q and high current capability.

The CP0302/CP0402/CP0603/CP0805 series of Directional Couplers cover the frequency range of 800 MHz to 6 GHz. They feature low insertion loss, high directivity and highly accurate coupling factors.

The LP0402/0603/0805 series of Low Pass Filters provide a rugged component in a small size package with excellent high frequency performance.

The Multilayer Organic (MLO™) series of components are based on AVX's patented multilayer organic technology (US patent 6,987,307). They are low profile with frequencies well above 1GHz.

Another major series of microwave capacitors consists of both multilayer porcelain and ceramic capacitors for frequencies from 10 MHz to 4.2 GHz (UQ and SQ Series). Six sizes of specially designed ultra-low ESR C0G (NP0) capacitors are covered for RF applications (CU and U Series).

The air core and wire wound ceramic chip inductors offer high current ratings (up to 4.4A) and quality factor (>100).

Ask the world of us. Call (864) 967-2150.

Or visit our website <http://www.avx.com>

AVX RF

**Thin-Film RF/Microwave
Capacitor Technology**

Accu-P®

Thin-Film Technology

THE IDEAL CAPACITOR

The non-ideal characteristics of a real capacitor can be ignored at low frequencies. Physical size imparts inductance to the capacitor and dielectric and metal electrodes result in resistive losses, but these often are of negligible effect on the circuit. At the very high frequencies of radio communication (>100MHz) and satellite systems (>1GHz), these effects become important. Recognizing that a real capacitor will exhibit inductive and resistive impedances in addition to capacitance, the ideal capacitor for these high frequencies is an ultra low loss component which can be fully characterized in all parameters with total repeatability from unit to unit.

Until recently, most high frequency/microwave capacitors were based on fired-ceramic (porcelain) technology. Layers of ceramic dielectric material and metal alloy electrode paste are interleaved and then sintered in a high temperature oven. This technology exhibits component variability in dielectric quality (losses, dielectric constant and insulation resistance), variability in electrode conductivity and variability in physical size (affecting inductance). An alternate thin-film technology has been developed which virtually eliminates these variances. It is this technology which has been fully incorporated into Accu-P® and Accu-P® to provide high frequency capacitors exhibiting truly ideal characteristics.

The main features of Accu-P® may be summarized as follows:

- High purity of electrodes for very low and repeatable ESR.
- Highly pure, low-K dielectric for high breakdown field, high insulation resistance and low losses to frequencies above 40GHz.
- Very tight dimensional control for uniform inductance, unit to unit.
- Very tight capacitance tolerances for high frequency signal applications.

This accuracy sets apart these Thin-Film capacitors from ceramic capacitors so that the term Accu has been employed as the designation for this series of devices, an abbreviation for “accurate.”

THIN-FILM TECHNOLOGY

Thin-film technology is commonly used in producing semiconductor devices. In the last two decades, this technology has developed tremendously, both in performance and in process control. Today’s techniques enable line definitions of below 1µm, and the controlling of thickness of layers at 100Å (10⁻²µm). Applying this technology to the manufacture of capacitors has enabled the development of components where both electrical and physical properties can be tightly controlled.

The thin-film production facilities at AVX consist of:

- Class 1000 clean rooms, with working areas under laminar-flow hoods of class 100, (below 100 particles per cubic foot larger than 0.5µm).
- High vacuum metal deposition systems for high-purity electrode construction.
- Photolithography equipment for line definition down to 2.0µm accuracy.
- Plasma-enhanced CVD for various dielectric depositions (CVD=Chemical Vapor Deposition).
- High accuracy, microprocessor-controlled dicing saws for chip separation.
- High speed, high accuracy sorting to ensure strict tolerance adherence.

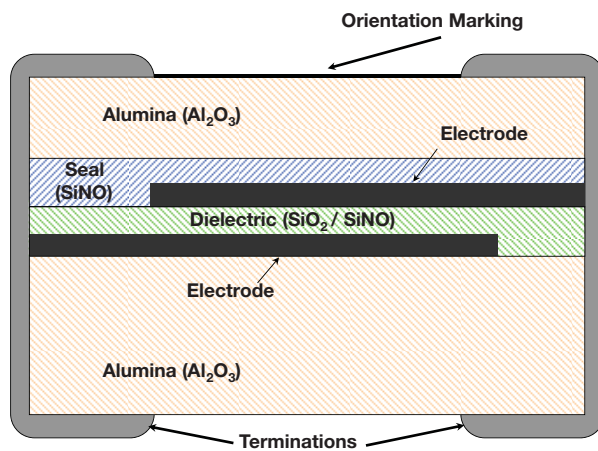

ACCU-P® CAPACITOR STRUCTURE

Thin-Film Chip Capacitors

ACCU-P® TECHNOLOGY

The use of very low-loss dielectric materials, silicon dioxide and silicon oxynitride, in conjunction with highly conductive electrode metals results in low ESR and high Q. These high-frequency characteristics change at a slower rate with increasing frequency than for ceramic microwave capacitors.

Because of the thin-film technology, the above-mentioned frequency characteristics are obtained without significant compromise of properties required for surface mounting.

The main Accu-P® properties are:

- Internationally agreed sizes with excellent dimensional control.
- Ultra small size chip capacitors (01005) are available.
- Ultra tight capacitance tolerances.
- Low ESR at VHF, UHF and microwave frequencies.
- Enhanced RF power handling capability.
- High stability with respect to time, temperature, frequency and voltage variation.
- Nickel/solder-coated terminations to provide excellent solderability and leach resistance.

ACCU-P® FEATURES

Accu-P® meets the fast-growing demand for low-loss (high-Q) capacitors for use in surface mount technology especially for the mobile communications market, such as cellular radio of 450 and 900 MHz, UHF walkie-talkies, UHF cordless telephones to 2.3 GHz, low noise blocks at 11-12.5 GHz and for other VHF, UHF and microwave applications.

Accu-P® is currently unique in its ability to offer very low capacitance values (0.05pF) and very tight capacitance tolerances ($\pm 0.01\text{pF}$).

- The RF power handling capability of the Accu-P® allows for its usage in both small signal and RF power applications.
- Thin Film Technology guarantees minimal batch to batch variability of parameters at high frequency.
- Inspection test and quality control procedures in accordance with ISO 9001, CECC, IECQ and USA MIL Standards yield products of the highest quality.
- Hand soldering Accu-P®: Due to their construction utilizing relatively high thermal conductivity materials, Accu-P's have become the preferred device in R & D labs and production environments where hand soldering is used.

APPLICATIONS

Cellular Communications
CT2/PCN (Cordless Telephone/Personal Comm. Networks)
Satellite TV
Cable TV
GPS (Global Positioning Systems)
Vehicle Location Systems
Vehicle Alarm Systems
Paging
Military Communications

Radar Systems
Video Switching
Test & Measurements
Filters
VCO's
Matching Networks
RF Amplifiers

APPROVALS

ISO 9001

Accu-P[®]

Thin-Film Chip Capacitors for RF Signal and Power Applications

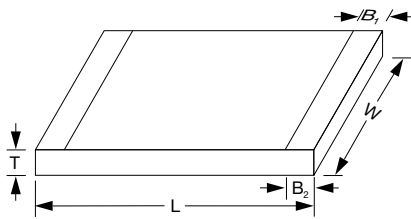

ACCU-P[®] (Signal and Power Type Capacitors)

| | 01005* | 0201* | 0402* | 0603* | 0805* | 1210 |
|----------------|--|-------------------------------|--|----------------------------|---------------------------|---------------------------|
| L | 0.405±0.020 (0.016±0.001) | 0.60±0.05 (0.023±0.002) | 1.00±0.1 (0.039±0.004) | 1.60±0.1 (0.063±0.004) | 2.01±0.1 (0.079±0.004) | 3.02±0.1 (0.119±0.004) |
| W | 0.215 ± 0.020 (0.0085 ± 0.001) | 0.325±0.050 (0.0128±0.002) | 0.55±0.07 (0.022±0.003) | 0.81±0.1 (0.032±0.004) | 1.27±0.1 (0.050±0.004) | 2.5±0.1 (0.100±0.004) |
| T | 0.145 ± 0.020 (0.006 ± 0.001) | 0.225±0.050 (0.009±0.002) | 0.40±0.1 (0.016±0.004) | 0.63±0.1 (0.025±0.004) | 0.93±0.2 (0.036±0.008) | 0.93±0.2 (0.036±0.008) |
| B ₁ | 0.00 ^{+0.1} _{-0.0} (0.000 ^{+0.004} _{-0.000}) | 0.10±0.10 (0.004±0.004) | 0.00 ^{+0.1} _{-0.0} (0.000 ^{+0.004} _{-0.000}) | 0.35±0.15 (0.014±0.006) | 0.30±0.1 (0.012±0.004) | 0.43±0.1 (0.017±0.004) |
| B ₂ | 0.10 ± 0.03 (0.004 ± 0.001) | 0.15±0.05 (0.006±0.002) | 0.20±0.1 (0.008±0.004) | 0.35±0.15 (0.014±0.006) | 0.30±0.1 (0.012±0.004) | 0.43±0.1 (0.017±0.004) |

*Mount Black Side Up

DIMENSIONS: millimeters (inches)

HOW TO ORDER

0402

Size
C005
0201
0402
0603
0805
1210*

3

Voltage
2 = 200V
1 = 100V
5 = 50V
3 = 25V
Y = 16V
Z = 10V

J

Temperature Coefficient (1)
J = 0±30ppm/°C
(-55°C to +125°C)
K = 0±60ppm/°C
(-55°C to +125°C)

4R7

Capacitance
Capacitance expressed in pF. (2 significant digits + number of zeros)
for values <10pF, letter R denotes decimal point.
Example:
68pF = 680
8.2pF = 8R2

A

Tolerance for C≤2.0pF*
Z = ±0.01pF
P = ±0.02pF
Q = ±0.03pF
A = ±0.05pF
B = ±0.1pF
C = ±0.25pF

for C≤3.0pF
Q = ±0.03pF
A = ±0.05pF
B = ±0.1pF
C = ±0.25pF

for C≤5.6pF
A = ±0.05pF
B = ±0.1pF
C = ±0.25pF

for 5.6pF<C<10pF
B = ±0.1pF
C = ±0.25pF
D = ±0.5pF

for C≥10pF
F = ±1%
G = ±2%
J = ±5%

B

Specification Code
B = Accu-P[®] technology

S

Termination Code

W = Nickel/Solder Coated
Accu-P[®] 0402 Sn90, Pb10***
T = Nickel/High Temperature Solder Coated
Accu-P[®] 0805, 1210**** Sn96, Ag4
Nickel/Solder Coated
Accu-P[®] 0603*** Sn63, Pb37
**S = Nickel/Lead Free Solder Coated
Accu-P[®] 01005, 0201, 0402, 0603 Sn100

**RoHS compliant

*** Not RoHS Compliant

TR

Packaging Code

TR = Tape & Reel

(1) TC's shown are per EIA/IEC Specifications.

Engineering Kits Available
see pages 118-119

*Tolerances as tight as ±0.01pF are available. Please consult the factory.



LEAD-FREE
LEAD-FREE COMPATIBLE
COMPONENT



RoHS
COMPLIANT

For RoHS compliant products,
please select correct termination style.

ELECTRICAL SPECIFICATIONS

| | |
|---|--|
| Operating and Storage Temperature Range | -55°C to +125°C |
| Temperature Coefficients ⁽¹⁾ | 0 ± 30ppm/°C dielectric code "J" / 0 ± 60ppm/°C dielectric code "K" |
| Capacitance Measurement | 1 MHz, 1 Vrms |
| Insulation Resistance (IR) | ≥10 ¹¹ Ohms (≥10 ¹⁰ Ohms for 0201 and 0402 size) |
| Proof Voltage | 2.5 U _R for 5 secs. |
| Aging Characteristic | Zero |
| Dielectric Absorption | 0.01% |

Signal and Power Type Capacitors

Accu-P® Capacitance Ranges (pF)

TEMP. COEFFICIENT CODE

“J” = 0±30ppm/°C (-55°C to +125°C)⁽²⁾ “K” = 0±60ppm/°C (-55°C to +125°C)⁽²⁾

| Size | | 0201 | | | | | 0402 | | | | | 0603 | | | | 0805 | | | 1210 | | | | |
|--------------------------|----------|------|-----|----|----|----|------|-----|-----|----|----|------|----|-----|-----|------|----|-----|------|----|-----|----|--|
| Size Code | C005 | 16 | 100 | 50 | 25 | 16 | 10 | 200 | 100 | 50 | 25 | 16 | 10 | 200 | 100 | 50 | 25 | 100 | 50 | 25 | 100 | 50 | |
| Cap in pF ⁽¹⁾ | Cap code | | | | | | | | | | | | | | | | | | | | | | |
| 0.1 | — 0R1 | | | | | | | | | | | | | | | | | | | | | | |
| 0.2 | — 0R2 | | | | | | | | | | | | | | | | | | | | | | |
| 0.3 | — 0R3 | | | | | | | | | | | | | | | | | | | | | | |
| 0.4 | — 0R4 | | | | | | | | | | | | | | | | | | | | | | |
| 0.5 | — 0R5 | | | | | | | | | | | | | | | | | | | | | | |
| 0.6 | — 0R6 | | | | | | | | | | | | | | | | | | | | | | |
| 0.7 | — 0R7 | | | | | | | | | | | | | | | | | | | | | | |
| 0.8 | — 0R8 | | | | | | | | | | | | | | | | | | | | | | |
| 0.9 | — 0R9 | | | | | | | | | | | | | | | | | | | | | | |
| 1.0 | — 1R0 | | | | | | | | | | | | | | | | | | | | | | |
| 1.1 | — 1R1 | | | | | | | | | | | | | | | | | | | | | | |
| 1.2 | — 1R2 | | | | | | | | | | | | | | | | | | | | | | |
| 1.3 | — 1R3 | | | | | | | | | | | | | | | | | | | | | | |
| 1.4 | — 1R4 | | | | | | | | | | | | | | | | | | | | | | |
| 1.5 | — 1R5 | | | | | | | | | | | | | | | | | | | | | | |
| 1.6 | — 1R6 | | | | | | | | | | | | | | | | | | | | | | |
| 1.7 | — 1R7 | | | | | | | | | | | | | | | | | | | | | | |
| 1.8 | — 1R8 | | | | | | | | | | | | | | | | | | | | | | |
| 1.9 | — 1R9 | | | | | | | | | | | | | | | | | | | | | | |
| 2.0 | — 2R0 | | | | | | | | | | | | | | | | | | | | | | |
| 2.1 | — 2R1 | | | | | | | | | | | | | | | | | | | | | | |
| 2.2 | — 2R2 | | | | | | | | | | | | | | | | | | | | | | |
| 2.3 | — 2R3 | | | | | | | | | | | | | | | | | | | | | | |
| 2.4 | — 2R4 | | | | | | | | | | | | | | | | | | | | | | |
| 2.5 | — 2R5 | | | | | | | | | | | | | | | | | | | | | | |
| 2.6 | — 2R6 | | | | | | | | | | | | | | | | | | | | | | |
| 2.7 | — 2R7 | | | | | | | | | | | | | | | | | | | | | | |
| 2.8 | — 2R8 | | | | | | | | | | | | | | | | | | | | | | |
| 2.9 | — 2R9 | | | | | | | | | | | | | | | | | | | | | | |
| 3.0 | — 3R0 | | | | | | | | | | | | | | | | | | | | | | |
| 3.1 | — 3R1 | | | | | | | | | | | | | | | | | | | | | | |
| 3.2 | — 3R2 | | | | | | | | | | | | | | | | | | | | | | |
| 3.3 | — 3R3 | | | | | | | | | | | | | | | | | | | | | | |
| 3.4 | — 3R4 | | | | | | | | | | | | | | | | | | | | | | |
| 3.5 | — 3R5 | | | | | | | | | | | | | | | | | | | | | | |
| 3.6 | — 3R6 | | | | | | | | | | | | | | | | | | | | | | |
| 3.7 | — 3R7 | | | | | | | | | | | | | | | | | | | | | | |
| 3.8 | — 3R8 | | | | | | | | | | | | | | | | | | | | | | |
| 3.9 | — 3R9 | | | | | | | | | | | | | | | | | | | | | | |
| 4.0 | — 4R0 | | | | | | | | | | | | | | | | | | | | | | |
| 4.1 | — 4R1 | | | | | | | | | | | | | | | | | | | | | | |
| 4.2 | — 4R2 | | | | | | | | | | | | | | | | | | | | | | |
| 4.3 | — 4R3 | | | | | | | | | | | | | | | | | | | | | | |
| 4.4 | — 4R4 | | | | | | | | | | | | | | | | | | | | | | |
| 4.5 | — 4R5 | | | | | | | | | | | | | | | | | | | | | | |
| 4.6 | — 4R6 | | | | | | | | | | | | | | | | | | | | | | |
| 4.7 | — 4R7 | | | | | | | | | | | | | | | | | | | | | | |
| 5.1 | — 5R1 | | | | | | | | | | | | | | | | | | | | | | |
| 5.6 | — 5R6 | | | | | | | | | | | | | | | | | | | | | | |
| 6.2 | — 6R2 | | | | | | | | | | | | | | | | | | | | | | |
| 6.8 | — 6R8 | | | | | | | | | | | | | | | | | | | | | | |
| 7.5 | — 7R5 | | | | | | | | | | | | | | | | | | | | | | |
| 8.2 | — 8R2 | | | | | | | | | | | | | | | | | | | | | | |
| 9.1 | — 9R1 | | | | | | | | | | | | | | | | | | | | | | |
| 10.0 | — 100 | | | | | | | | | | | | | | | | | | | | | | |
| 11.0 | — 110 | | | | | | | | | | | | | | | | | | | | | | |
| 12.0 | — 120 | | | | | | | | | | | | | | | | | | | | | | |
| 13.0 | — 130 | | | | | | | | | | | | | | | | | | | | | | |
| 14.0 | — 140 | | | | | | | | | | | | | | | | | | | | | | |
| 15.0 | — 150 | | | | | | | | | | | | | | | | | | | | | | |
| 16.0 | — 160 | | | | | | | | | | | | | | | | | | | | | | |
| 17.0 | — 170 | | | | | | | | | | | | | | | | | | | | | | |
| 18.0 | — 180 | | | | | | | | | | | | | | | | | | | | | | |
| 19.0 | — 190 | | | | | | | | | | | | | | | | | | | | | | |
| 20.0 | — 200 | | | | | | | | | | | | | | | | | | | | | | |
| 21.0 | — 210 | | | | | | | | | | | | | | | | | | | | | | |
| 22.0 | — 220 | | | | | | | | | | | | | | | | | | | | | | |
| 24.0 | — 240 | | | | | | | | | | | | | | | | | | | | | | |
| 27.0 | — 270 | | | | | | | | | | | | | | | | | | | | | | |
| 30.0 | — 300 | | | | | | | | | | | | | | | | | | | | | | |
| 33.0 | — 330 | | | | | | | | | | | | | | | | | | | | | | |
| 39.0 | — 390 | | | | | | | | | | | | | | | | | | | | | | |
| 47.0 | — 470 | | | | | | | | | | | | | | | | | | | | | | |
| 56.0 | — 560 | | | | | | | | | | | | | | | | | | | | | | |
| 68.0 | — 680 | | | | | | | | | | | | | | | | | | | | | | |

⁽¹⁾ For capacitance values higher than listed in table, please consult factory.

⁽²⁾ TC shown is per EIA/IEC Specifications.

These values are produced with “K” temperature coefficient code only.

Intermediate values are available within the indicated range.



0201 Typical Electrical Tables

1

| Capacitance @ 1MHz and Tolerance | | Self Resonance Frequency (GHz) Typ. | Q Standard Value @ 1GHz | | Frequency 900MHz | | | Frequency 1900MHz | | | Frequency 2400MHz | | |
|----------------------------------|-------|-------------------------------------|-------------------------|------|------------------|--------|-----------------|-------------------|--------|-----------------|-------------------|--------|-----------------|
| C (pF) | Tol. | | Typ. | Min. | C(eff) (pF) Typ. | Q Typ. | ESR (mOhm) Typ. | C(eff) (pF) Typ. | Q Typ. | ESR (mOhm) Typ. | C(eff) (pF) Typ. | Q Typ. | ESR (mOhm) Typ. |
| 0.05 | ±0.02 | 20.9 | 599 | 402 | 0.055 | 650 | 3220 | 0.056 | 265 | 4010 | 0.057 | 195 | 4450 |
| 0.1 | ±0.02 | 19.4 | 574 | 316 | 0.110 | 614 | 2682 | 0.112 | 246 | 3036 | 0.113 | 188 | 3113 |
| 0.15 | ±0.02 | 17.9 | 510 | 280 | 0.163 | 550 | 2087 | 0.166 | 220 | 2404 | 0.168 | 170 | 2441 |
| 0.2 | ±0.02 | 16.4 | 445 | 245 | 0.216 | 520 | 1693 | 0.220 | 210 | 1971 | 0.223 | 160 | 1970 |
| 0.25 | ±0.02 | 15.5 | 436 | 240 | 0.262 | 510 | 1371 | 0.268 | 204 | 1604 | 0.272 | 153 | 1646 |
| 0.3 | ±0.02 | 14.6 | 427 | 235 | 0.309 | 500 | 1149 | 0.316 | 199 | 1337 | 0.320 | 146 | 1421 |
| 0.35 | ±0.02 | 14.1 | 423 | 232 | 0.360 | 494 | 1001 | 0.369 | 196 | 1177 | 0.374 | 144 | 1265 |
| 0.4 | ±0.02 | 12.5 | 418 | 230 | 0.411 | 489 | 874 | 0.421 | 193 | 1038 | 0.427 | 142 | 1129 |
| 0.45 | ±0.02 | 11.9 | 413 | 227 | 0.461 | 484 | 819 | 0.473 | 191 | 972 | 0.481 | 140 | 1066 |
| 0.5 | ±0.02 | 11.3 | 408 | 224 | 0.512 | 478 | 765 | 0.526 | 188 | 906 | 0.535 | 138 | 1003 |
| 0.55 | ±0.02 | 10.9 | 403 | 222 | 0.563 | 473 | 710 | 0.578 | 186 | 840 | 0.588 | 137 | 940 |
| 0.6 | ±0.02 | 10.4 | 398 | 219 | 0.614 | 468 | 667 | 0.631 | 183 | 791 | 0.642 | 135 | 882 |
| 0.65 | ±0.02 | 10.0 | 394 | 217 | 0.664 | 462 | 624 | 0.683 | 181 | 742 | 0.695 | 133 | 825 |
| 0.7 | ±0.02 | 9.5 | 389 | 214 | 0.715 | 457 | 580 | 0.735 | 178 | 693 | 0.749 | 131 | 767 |
| 0.75 | ±0.02 | 9.3 | 384 | 211 | 0.766 | 452 | 557 | 0.788 | 176 | 664 | 0.802 | 129 | 729 |
| 0.8 | ±0.02 | 9.1 | 379 | 209 | 0.817 | 446 | 534 | 0.840 | 173 | 635 | 0.856 | 127 | 692 |
| 0.85 | ±0.02 | 8.9 | 374 | 206 | 0.868 | 441 | 511 | 0.893 | 171 | 606 | 0.909 | 126 | 654 |
| 0.9 | ±0.02 | 8.8 | 370 | 203 | 0.918 | 436 | 487 | 0.945 | 168 | 577 | 0.963 | 124 | 616 |
| 0.95 | ±0.02 | 8.6 | 365 | 201 | 0.969 | 430 | 464 | 0.998 | 166 | 548 | 1.016 | 122 | 579 |
| 1 | ±0.02 | 8.4 | 360 | 198 | 1.020 | 425 | 441 | 1.050 | 163 | 519 | 1.070 | 120 | 541 |
| 1.05 | ±0.02 | 8.2 | 358 | 197 | 1.078 | 421 | 426 | 1.112 | 161 | 502 | 1.134 | 119 | 523 |
| 1.1 | ±0.02 | 8.0 | 355 | 195 | 1.135 | 418 | 410 | 1.173 | 159 | 486 | 1.199 | 117 | 505 |
| 1.15 | ±0.02 | 7.8 | 353 | 194 | 1.193 | 414 | 395 | 1.235 | 157 | 469 | 1.263 | 116 | 488 |
| 1.2 | ±0.02 | 7.6 | 350 | 193 | 1.251 | 411 | 379 | 1.296 | 155 | 452 | 1.327 | 115 | 470 |
| 1.25 | ±0.02 | 7.5 | 348 | 191 | 1.308 | 407 | 364 | 1.358 | 153 | 436 | 1.392 | 114 | 452 |
| 1.3 | ±0.02 | 7.4 | 345 | 190 | 1.366 | 403 | 348 | 1.419 | 151 | 419 | 1.456 | 112 | 434 |
| 1.35 | ±0.02 | 7.3 | 343 | 189 | 1.424 | 400 | 333 | 1.481 | 149 | 402 | 1.520 | 111 | 416 |
| 1.4 | ±0.02 | 7.2 | 340 | 187 | 1.481 | 396 | 317 | 1.542 | 147 | 386 | 1.585 | 110 | 398 |
| 1.45 | ±0.02 | 7.1 | 338 | 186 | 1.539 | 393 | 302 | 1.604 | 145 | 369 | 1.649 | 109 | 381 |
| 1.5 | ±0.02 | 7.0 | 335 | 184 | 1.597 | 389 | 287 | 1.665 | 144 | 353 | 1.713 | 107 | 363 |
| 1.55 | ±0.02 | 6.8 | 332 | 183 | 1.642 | 386 | 282 | 1.714 | 142 | 347 | 1.764 | 106 | 358 |
| 1.6 | ±0.02 | 6.7 | 330 | 181 | 1.687 | 382 | 277 | 1.762 | 141 | 342 | 1.815 | 105 | 352 |
| 1.65 | ±0.02 | 6.6 | 327 | 180 | 1.732 | 378 | 272 | 1.810 | 140 | 337 | 1.866 | 104 | 347 |
| 1.7 | ±0.02 | 6.5 | 324 | 178 | 1.777 | 375 | 267 | 1.859 | 138 | 331 | 1.917 | 103 | 342 |
| 1.75 | ±0.02 | 6.4 | 321 | 176 | 1.822 | 371 | 262 | 1.907 | 137 | 326 | 1.968 | 102 | 337 |
| 1.8 | ±0.02 | 6.3 | 318 | 175 | 1.866 | 367 | 257 | 1.955 | 136 | 321 | 2.018 | 101 | 331 |
| 1.85 | ±0.02 | 6.2 | 315 | 173 | 1.911 | 364 | 252 | 2.003 | 134 | 316 | 2.069 | 100 | 326 |
| 1.9 | ±0.02 | 6.2 | 312 | 172 | 1.956 | 360 | 247 | 2.052 | 133 | 310 | 2.120 | 99 | 321 |
| 1.95 | ±0.02 | 6.1 | 309 | 170 | 2.001 | 357 | 242 | 2.100 | 132 | 305 | 2.171 | 98 | 316 |
| 2 | ±0.03 | 6.0 | 306 | 168 | 2.046 | 353 | 237 | 2.148 | 131 | 300 | 2.222 | 97 | 310 |
| 2.1 | ±0.03 | 5.9 | 301 | 166 | 2.150 | 348 | 232 | 2.263 | 128 | 293 | 2.344 | 95 | 303 |
| 2.2 | ±0.03 | 5.7 | 296 | 163 | 2.254 | 343 | 227 | 2.377 | 125 | 287 | 2.467 | 93 | 296 |
| 2.3 | ±0.03 | 5.6 | 292 | 160 | 2.358 | 337 | 222 | 2.491 | 122 | 281 | 2.590 | 91 | 289 |
| 2.4 | ±0.03 | 5.5 | 287 | 158 | 2.462 | 332 | 217 | 2.606 | 120 | 274 | 2.712 | 89 | 282 |
| 2.5 | ±0.03 | 5.4 | 282 | 155 | 2.566 | 327 | 212 | 2.720 | 117 | 268 | 2.835 | 87 | 275 |
| 2.6 | ±0.03 | 5.3 | 277 | 152 | 2.670 | 322 | 207 | 2.834 | 114 | 262 | 2.958 | 85 | 268 |
| 2.7 | ±0.03 | 5.2 | 272 | 150 | 2.773 | 317 | 202 | 2.949 | 112 | 255 | 3.080 | 83 | 261 |
| 2.8 | ±0.03 | 5.1 | 269 | 148 | 2.878 | 312 | 199 | 3.066 | 110 | 252 | 3.209 | 81 | 258 |
| 2.9 | ±0.03 | 5.0 | 265 | 146 | 2.983 | 308 | 196 | 3.184 | 108 | 248 | 3.337 | 80 | 254 |
| 3 | ±0.03 | 4.9 | 261 | 144 | 3.088 | 304 | 193 | 3.301 | 106 | 245 | 3.465 | 78 | 251 |
| 3.1 | ±0.05 | 4.8 | 257 | 141 | 3.192 | 299 | 190 | 3.419 | 105 | 241 | 3.593 | 77 | 247 |
| 3.2 | ±0.05 | 4.7 | 253 | 139 | 3.297 | 295 | 187 | 3.536 | 103 | 238 | 3.722 | 76 | 244 |
| 3.3 | ±0.05 | 4.6 | 250 | 137 | 3.402 | 291 | 185 | 3.654 | 101 | 234 | 3.850 | 74 | 240 |
| 3.4 | ±0.05 | 4.6 | 246 | 135 | 3.506 | 286 | 182 | 3.771 | 99 | 231 | 3.978 | 73 | 237 |
| 3.5 | ±0.05 | 4.5 | 242 | 133 | 3.611 | 282 | 179 | 3.889 | 98 | 227 | 4.107 | 71 | 233 |
| 3.6 | ±0.05 | 4.5 | 238 | 131 | 3.716 | 278 | 176 | 4.006 | 96 | 224 | 4.235 | 70 | 230 |
| 3.7 | ±0.05 | 4.4 | 234 | 129 | 3.820 | 273 | 173 | 4.124 | 94 | 220 | 4.363 | 69 | 226 |
| 3.8 | ±0.05 | 4.4 | 230 | 127 | 3.925 | 269 | 170 | 4.241 | 92 | 217 | 4.492 | 67 | 223 |
| 3.9 | ±0.05 | 4.3 | 227 | 125 | 4.030 | 265 | 167 | 4.359 | 91 | 213 | 4.620 | 66 | 219 |

0201 Typical Electrical Tables

| Capacitance @ 1MHz and Tolerance | | Self Resonance Frequency (GHz) Typ. | Q Standard Value @ 1GHz | | Frequency 900MHz | | | Frequency 1900MHz | | | Frequency 2400MHz | | |
|----------------------------------|-------|-------------------------------------|-------------------------|------|------------------|--------|-----------------|-------------------|--------|-----------------|-------------------|--------|-----------------|
| C (pF) | Tol. | | Typ. | Min. | C(eff) (pF) Typ. | Q Typ. | ESR (mOhm) Typ. | C(eff) (pF) Typ. | Q Typ. | ESR (mOhm) Typ. | C(eff) (pF) Typ. | Q Typ. | ESR (mOhm) Typ. |
| 4 | ±0.05 | 4.3 | 224 | 123 | 4.138 | 262 | 165 | 4.484 | 89 | 210 | 4.760 | 65 | 216 |
| 4.1 | ±0.05 | 4.2 | 222 | 122 | 4.247 | 259 | 162 | 4.610 | 88 | 207 | 4.901 | 64 | 213 |
| 4.2 | ±0.05 | 4.2 | 220 | 121 | 4.356 | 257 | 159 | 4.735 | 87 | 204 | 5.041 | 63 | 210 |
| 4.3 | ±0.05 | 4.1 | 218 | 120 | 4.464 | 254 | 157 | 4.860 | 86 | 201 | 5.181 | 62 | 207 |
| 4.4 | ±0.05 | 4.1 | 216 | 119 | 4.573 | 252 | 154 | 4.986 | 85 | 198 | 5.322 | 61 | 204 |
| 4.5 | ±0.05 | 4.0 | 214 | 118 | 4.682 | 249 | 152 | 5.111 | 83 | 195 | 5.462 | 60 | 201 |
| 4.6 | ±0.05 | 4.0 | 212 | 116 | 4.790 | 246 | 149 | 5.237 | 82 | 192 | 5.602 | 59 | 198 |
| 4.7 | ±0.05 | 3.9 | 209 | 115 | 4.899 | 244 | 147 | 5.362 | 81 | 189 | 5.743 | 58 | 195 |
| 5.1 | ±0.05 | 3.8 | 201 | 110 | 5.334 | 233 | 136 | 5.863 | 76 | 178 | 6.304 | 54 | 183 |
| 5.6 | ±0.05 | 3.6 | 190 | 105 | 5.877 | 220 | 124 | 6.490 | 70 | 163 | 7.006 | 49 | 168 |
| 6.2 | ±0.1 | 3.5 | 177 | 97 | 6.488 | 208 | 126 | 7.290 | 65 | 167 | 7.993 | 45 | 174 |
| 6.8 | ±0.1 | 3.3 | 164 | 90 | 7.100 | 195 | 128 | 8.090 | 60 | 171 | 8.980 | 41 | 179 |
| 7.5 | ±0.1 | 3.2 | 153 | 84 | 7.901 | 182 | 125 | 9.129 | 56 | 166 | 10.27 | 38 | 173 |
| 8.2 | ±0.1 | 3.0 | 142 | 78 | 8.701 | 168 | 121 | 10.17 | 52 | 160 | 11.56 | 34 | 167 |
| 9.1 | ±0.1 | 2.9 | 135 | 74 | 9.676 | 159 | 118 | 11.57 | 49 | 154 | 13.49 | 32 | 161 |
| 10 | ±1% | 2.8 | 128 | 70 | 10.65 | 151 | 114 | 12.96 | 45 | 148 | 15.41 | 29 | 155 |
| 11 | ±1% | 2.7 | 120 | 66 | 11.73 | 141 | 110 | 14.52 | 42 | 142 | 17.55 | 27 | 148 |
| 12 | ±1% | 2.5 | 112 | 62 | 12.82 | 132 | 105 | 16.07 | 39 | 135 | 19.68 | 24 | 141 |
| 13 | ±1% | 2.4 | 105 | 58 | 13.92 | 124 | 104 | 17.82 | 36 | 135 | 22.38 | 22 | 142 |
| 14 | ±1% | 2.4 | 98 | 54 | 15.02 | 116 | 103 | 19.57 | 32 | 135 | 25.08 | 19 | 142 |
| 15 | ±1% | 2.3 | 91 | 50 | 16.12 | 108 | 102 | 21.32 | 29 | 135 | 27.78 | 17 | 143 |
| 16 | ±1% | 2.2 | 86 | 47 | 17.37 | 102 | 103 | 24.04 | 27 | 135 | NA | NA | NA |
| 17 | ±1% | 2.2 | 81 | 44 | 18.63 | 96 | 105 | 26.76 | 25 | 136 | NA | NA | NA |
| 18 | ±1% | 2.1 | 76 | 42 | 19.88 | 90 | 106 | 29.48 | 23 | 136 | NA | NA | NA |
| 19 | ±1% | 2.1 | 71 | 39 | 21.14 | 83 | 108 | 32.20 | 21 | 136 | NA | NA | NA |
| 20 | ±1% | 2.1 | 65 | 36 | 22.39 | 77 | 109 | 34.92 | 19 | 136 | NA | NA | NA |
| 22 | ±1% | 2.0 | 55 | 30 | 24.90 | 65 | 112 | 40.36 | 15 | 137 | NA | NA | NA |



0402 Typical Electrical Tables

1

| Capacitance @ 1MHz and Tolerance | | Self Resonance Frequency (GHz) Typ. | Q Standard Value @ 1GHz | | Frequency 900MHz | | | Frequency 1900MHz | | | Frequency 2400MHz | | |
|----------------------------------|-------|-------------------------------------|-------------------------|------|------------------|--------|-----------------|-------------------|--------|-----------------|-------------------|--------|-----------------|
| C (pF) | Tol. | | Typ. | Min. | C(eff) (pF) Typ. | Q Typ. | ESR (mOhm) Typ. | C(eff) (pF) Typ. | Q Typ. | ESR (mOhm) Typ. | C(eff) (pF) Typ. | Q Typ. | ESR (mOhm) Typ. |
| 0.05 | ±0.02 | 20.9 | 856 | 471 | 0.06 | 881 | 1411 | 0.06 | 562 | 1216 | 0.06 | 498 | 983 |
| 0.1 | ±0.02 | 19.4 | 848 | 466 | 0.11 | 873 | 1316 | 0.11 | 554 | 1115 | 0.11 | 490 | 914 |
| 0.15 | ±0.02 | 17.9 | 840 | 462 | 0.16 | 866 | 1222 | 0.16 | 547 | 1013 | 0.16 | 482 | 845 |
| 0.2 | ±0.02 | 16.4 | 832 | 457 | 0.21 | 858 | 1128 | 0.21 | 539 | 912 | 0.22 | 474 | 776 |
| 0.25 | ±0.02 | 15.5 | 823 | 453 | 0.26 | 850 | 1033 | 0.27 | 532 | 810 | 0.27 | 465 | 707 |
| 0.3 | ±0.02 | 14.6 | 815 | 448 | 0.31 | 842 | 939 | 0.32 | 525 | 708 | 0.32 | 457 | 638 |
| 0.35 | ±0.02 | 14.1 | 807 | 444 | 0.36 | 834 | 844 | 0.37 | 517 | 607 | 0.37 | 449 | 569 |
| 0.4 | ±0.02 | 12.5 | 799 | 439 | 0.41 | 827 | 750 | 0.42 | 510 | 505 | 0.42 | 441 | 500 |
| 0.45 | ±0.02 | 11.9 | 791 | 435 | 0.46 | 819 | 667 | 0.47 | 502 | 458 | 0.48 | 432 | 453 |
| 0.5 | ±0.02 | 11.3 | 783 | 430 | 0.51 | 811 | 583 | 0.52 | 495 | 410 | 0.53 | 424 | 407 |
| 0.55 | ±0.02 | 10.9 | 774 | 426 | 0.57 | 803 | 500 | 0.57 | 487 | 363 | 0.58 | 416 | 360 |
| 0.6 | ±0.02 | 10.4 | 766 | 421 | 0.62 | 796 | 465 | 0.62 | 480 | 343 | 0.63 | 408 | 339 |
| 0.65 | ±0.02 | 10.0 | 758 | 417 | 0.67 | 788 | 431 | 0.67 | 472 | 322 | 0.68 | 399 | 317 |
| 0.7 | ±0.02 | 9.5 | 750 | 413 | 0.72 | 780 | 396 | 0.72 | 465 | 302 | 0.73 | 391 | 296 |
| 0.75 | ±0.02 | 9.3 | 746 | 410 | 0.77 | 776 | 375 | 0.78 | 456 | 290 | 0.79 | 381 | 285 |
| 0.8 | ±0.02 | 9.1 | 743 | 408 | 0.82 | 772 | 354 | 0.83 | 447 | 277 | 0.84 | 370 | 273 |
| 0.85 | ±0.02 | 9.0 | 739 | 406 | 0.87 | 768 | 334 | 0.88 | 438 | 265 | 0.89 | 360 | 262 |
| 0.9 | ±0.02 | 8.8 | 735 | 404 | 0.92 | 764 | 313 | 0.93 | 429 | 253 | 0.95 | 350 | 250 |
| 0.95 | ±0.02 | 8.4 | 732 | 402 | 0.97 | 760 | 292 | 0.98 | 420 | 240 | 1.00 | 339 | 239 |
| 1 | ±0.02 | 8.0 | 728 | 400 | 1.02 | 756 | 271 | 1.04 | 411 | 228 | 1.05 | 329 | 227 |
| 1.05 | ±0.02 | 7.9 | 725 | 398 | 1.07 | 752 | 258 | 1.09 | 406 | 221 | 1.11 | 323 | 221 |
| 1.1 | ±0.02 | 7.8 | 721 | 397 | 1.12 | 749 | 245 | 1.14 | 401 | 214 | 1.16 | 318 | 214 |
| 1.15 | ±0.02 | 7.6 | 718 | 395 | 1.17 | 745 | 232 | 1.20 | 396 | 207 | 1.22 | 312 | 208 |
| 1.2 | ±0.02 | 7.4 | 714 | 393 | 1.22 | 742 | 218 | 1.25 | 391 | 200 | 1.27 | 306 | 202 |
| 1.25 | ±0.02 | 7.2 | 711 | 391 | 1.27 | 738 | 205 | 1.31 | 386 | 193 | 1.32 | 301 | 195 |
| 1.3 | ±0.02 | 7.0 | 707 | 389 | 1.32 | 734 | 192 | 1.36 | 381 | 185 | 1.38 | 295 | 189 |
| 1.35 | ±0.02 | 6.9 | 704 | 387 | 1.37 | 731 | 179 | 1.41 | 376 | 178 | 1.43 | 289 | 183 |
| 1.4 | ±0.02 | 6.8 | 700 | 385 | 1.42 | 727 | 165 | 1.47 | 371 | 171 | 1.49 | 283 | 177 |
| 1.45 | ±0.02 | 6.7 | 697 | 383 | 1.47 | 724 | 152 | 1.52 | 366 | 164 | 1.54 | 278 | 170 |
| 1.5 | ±0.02 | 6.5 | 693 | 381 | 1.52 | 720 | 139 | 1.58 | 361 | 157 | 1.60 | 272 | 164 |
| 1.55 | ±0.02 | 6.5 | 690 | 379 | 1.56 | 716 | 135 | 1.62 | 358 | 153 | 1.65 | 269 | 159 |
| 1.6 | ±0.02 | 6.5 | 686 | 377 | 1.61 | 713 | 130 | 1.67 | 355 | 148 | 1.70 | 267 | 155 |
| 1.65 | ±0.02 | 6.5 | 683 | 375 | 1.66 | 709 | 126 | 1.72 | 352 | 143 | 1.76 | 264 | 150 |
| 1.7 | ±0.02 | 6.4 | 679 | 373 | 1.71 | 705 | 122 | 1.77 | 349 | 139 | 1.81 | 261 | 146 |
| 1.75 | ±0.02 | 6.3 | 676 | 372 | 1.75 | 702 | 118 | 1.82 | 347 | 134 | 1.86 | 259 | 141 |
| 1.8 | ±0.02 | 6.2 | 672 | 370 | 1.80 | 698 | 113 | 1.87 | 344 | 130 | 1.92 | 256 | 137 |
| 1.85 | ±0.02 | 6.1 | 669 | 368 | 1.85 | 694 | 109 | 1.92 | 341 | 125 | 1.97 | 253 | 132 |
| 1.9 | ±0.02 | 6.0 | 665 | 366 | 1.90 | 690 | 105 | 1.97 | 338 | 121 | 2.02 | 251 | 128 |
| 1.95 | ±0.02 | 5.9 | 662 | 364 | 1.94 | 687 | 101 | 2.01 | 335 | 116 | 2.08 | 248 | 123 |
| 2 | ±0.03 | 5.7 | 658 | 362 | 1.99 | 683 | 96 | 2.06 | 332 | 112 | 2.13 | 245 | 119 |
| 2.1 | ±0.03 | 5.4 | 651 | 358 | 2.10 | 676 | 93 | 2.18 | 326 | 108 | 2.26 | 241 | 115 |
| 2.2 | ±0.03 | 5.1 | 643 | 354 | 2.21 | 669 | 89 | 2.30 | 321 | 104 | 2.38 | 236 | 112 |
| 2.3 | ±0.03 | 5.0 | 636 | 350 | 2.31 | 662 | 85 | 2.42 | 315 | 101 | 2.51 | 231 | 109 |
| 2.4 | ±0.03 | 4.9 | 629 | 346 | 2.42 | 656 | 81 | 2.54 | 309 | 97 | 2.64 | 226 | 106 |
| 2.5 | ±0.03 | 4.7 | 622 | 342 | 2.53 | 649 | 77 | 2.65 | 303 | 94 | 2.76 | 221 | 102 |
| 2.6 | ±0.03 | 4.6 | 614 | 338 | 2.64 | 642 | 74 | 2.77 | 298 | 90 | 2.89 | 216 | 99 |
| 2.7 | ±0.03 | 4.5 | 607 | 334 | 2.75 | 635 | 70 | 2.89 | 292 | 86 | 3.02 | 211 | 96 |
| 2.8 | ±0.03 | 4.5 | 600 | 330 | 2.85 | 628 | 68 | 3.01 | 288 | 83 | 3.15 | 207 | 92 |
| 2.9 | ±0.03 | 4.4 | 592 | 326 | 2.95 | 621 | 66 | 3.13 | 283 | 80 | 3.28 | 203 | 88 |
| 3 | ±0.03 | 4.4 | 585 | 322 | 3.06 | 614 | 64 | 3.24 | 279 | 76 | 3.41 | 200 | 84 |
| 3.1 | ±0.05 | 4.4 | 578 | 318 | 3.16 | 607 | 62 | 3.36 | 274 | 73 | 3.54 | 196 | 80 |
| 3.2 | ±0.05 | 4.3 | 570 | 314 | 3.27 | 600 | 60 | 3.48 | 270 | 70 | 3.67 | 192 | 76 |
| 3.3 | ±0.05 | 4.3 | 563 | 310 | 3.37 | 593 | 58 | 3.60 | 265 | 67 | 3.80 | 188 | 72 |
| 3.4 | ±0.05 | 4.3 | 556 | 306 | 3.47 | 586 | 57 | 3.71 | 261 | 63 | 3.93 | 184 | 68 |
| 3.5 | ±0.05 | 4.2 | 548 | 302 | 3.58 | 579 | 55 | 3.83 | 256 | 60 | 4.06 | 180 | 64 |
| 3.6 | ±0.05 | 4.2 | 541 | 298 | 3.68 | 572 | 53 | 3.95 | 252 | 57 | 4.19 | 177 | 60 |
| 3.7 | ±0.05 | 4.1 | 534 | 294 | 3.78 | 565 | 51 | 4.06 | 247 | 54 | 4.32 | 173 | 56 |
| 3.8 | ±0.05 | 4.0 | 526 | 289 | 3.89 | 558 | 49 | 4.18 | 243 | 50 | 4.45 | 169 | 52 |
| 3.9 | ±0.05 | 3.9 | 519 | 285 | 3.99 | 551 | 47 | 4.30 | 238 | 47 | 4.58 | 165 | 48 |

0402 Typical Electrical Tables

| Capacitance @ 1MHz and Tolerance | | Self Resonance Frequency (GHz) Typ. | Q Standard Value @ 1GHz | | Frequency 900MHz | | | Frequency 1900MHz | | | Frequency 2400MHz | | |
|----------------------------------|-------|-------------------------------------|-------------------------|------|------------------|--------|-----------------|-------------------|--------|-----------------|-------------------|--------|-----------------|
| C (pF) | Tol. | | Typ. | Min. | C(eff) (pF) Typ. | Q Typ. | ESR (mOhm) Typ. | C(eff) (pF) Typ. | Q Typ. | ESR (mOhm) Typ. | C(eff) (pF) Typ. | Q Typ. | ESR (mOhm) Typ. |
| 4 | ±0.05 | 3.9 | 513 | 282 | 4.10 | 545 | 47 | 4.42 | 235 | 47 | 4.73 | 162 | 48 |
| 4.1 | ±0.05 | 3.8 | 507 | 279 | 4.20 | 539 | 47 | 4.55 | 232 | 46 | 4.87 | 160 | 48 |
| 4.2 | ±0.05 | 3.8 | 501 | 275 | 4.30 | 534 | 46 | 4.67 | 228 | 46 | 5.01 | 157 | 48 |
| 4.3 | ±0.05 | 3.7 | 495 | 272 | 4.41 | 528 | 46 | 4.79 | 225 | 46 | 5.16 | 154 | 48 |
| 4.4 | ±0.05 | 3.7 | 489 | 269 | 4.51 | 522 | 46 | 4.92 | 222 | 46 | 5.30 | 151 | 47 |
| 4.5 | ±0.05 | 3.6 | 483 | 265 | 4.61 | 516 | 46 | 5.04 | 219 | 45 | 5.44 | 149 | 47 |
| 4.6 | ±0.05 | 3.6 | 477 | 262 | 4.72 | 511 | 45 | 5.16 | 216 | 45 | 5.59 | 146 | 47 |
| 4.7 | ±0.05 | 3.5 | 471 | 259 | 4.82 | 505 | 45 | 5.29 | 213 | 45 | 5.73 | 143 | 47 |
| 5.1 | ±0.05 | 3.4 | 446 | 245 | 5.23 | 482 | 44 | 5.78 | 200 | 43 | 6.30 | 133 | 47 |
| 5.6 | ±0.05 | 3.3 | 416 | 229 | 5.75 | 453 | 43 | 6.40 | 184 | 42 | 7.02 | 119 | 46 |
| 6.2 | ±0.1 | 3.0 | 388 | 213 | 6.41 | 427 | 44 | 7.26 | 167 | 44 | 8.11 | 107 | 47 |
| 6.8 | ±0.1 | 2.8 | 360 | 198 | 7.07 | 400 | 44 | 8.12 | 150 | 45 | 9.19 | 95 | 48 |
| 7.5 | ±0.1 | 2.7 | 338 | 186 | 7.85 | 378 | 45 | 9.17 | 139 | 47 | 10.57 | 86 | 49 |
| 8.2 | ±0.1 | 2.6 | 315 | 173 | 8.62 | 356 | 45 | 10.22 | 128 | 48 | 11.95 | 77 | 50 |
| 9.1 | ±0.1 | 2.5 | 292 | 160 | 9.63 | 333 | 45 | 11.75 | 115 | 47 | 14.23 | 69 | 50 |
| 10 | ±1% | 2.4 | 268 | 148 | 10.65 | 310 | 45 | 13.28 | 103 | 47 | 16.50 | 61 | 49 |
| 11 | ±1% | 2.3 | 242 | 133 | 11.77 | 285 | 44 | 14.98 | 89 | 46 | 19.04 | 51 | 49 |
| 12 | ±1% | 2.2 | 217 | 119 | 12.90 | 259 | 44 | 16.68 | 75 | 45 | 21.57 | 42 | 48 |
| 13 | ±1% | 2.2 | 202 | 111 | 14.03 | 241 | 44 | 18.83 | 68 | 47 | 25.73 | 38 | 49 |
| 14 | ±1% | 2.1 | 187 | 103 | 15.17 | 223 | 44 | 20.97 | 62 | 49 | 29.89 | 33 | 49 |
| 15 | ±1% | 2.1 | 172 | 94 | 16.30 | 204 | 45 | 23.12 | 56 | 51 | 34.05 | 29 | 50 |
| 16 | ±1% | 2.0 | 157 | 87 | 17.53 | 187 | 44 | 25.91 | 50 | 49 | 41.44 | 25 | 49 |
| 17 | ±1% | 1.9 | 143 | 79 | 18.75 | 169 | 43 | 28.70 | 45 | 46 | 48.82 | 21 | 47 |
| 18 | ±1% | 1.8 | 129 | 71 | 19.98 | 152 | 42 | 31.49 | 39 | 44 | 56.21 | 17 | 46 |
| 19 | ±1% | 1.8 | 121 | 67 | 21.11 | 143 | 42 | 33.51 | 36 | 44 | 60.92 | 15 | 47 |
| 20 | ±1% | 1.8 | 110 | 61 | 22.25 | 131 | 41 | 35.53 | 33 | 43 | 65.63 | 14 | 48 |
| 22 | ±1% | 1.8 | 98 | 54 | 24.51 | 116 | 41 | 39.57 | 26 | 42 | 75.05 | 10 | 51 |
| 24 | ±1% | 1.8 | 87 | 48 | 27.51 | 104 | 37 | 54.94 | 21 | 35 | NA | NA | NA |
| 27 | ±1% | 1.7 | 70 | 39 | 32.01 | 85 | 32 | 77.98 | 13 | 23 | NA | NA | NA |
| 30 | ±1% | 1.7 | 65 | 36 | 35.89 | 78 | 28 | 106.50 | 10 | 12 | NA | NA | NA |
| 33 | ±1% | 1.7 | 60 | 33 | 40.05 | 74 | 27 | NA | NA | NA | NA | NA | NA |
| 36 | ±1% | 1.7 | 58 | 32 | 45.13 | 71 | 28 | NA | NA | NA | NA | NA | NA |
| 39 | ±1% | 1.7 | 56 | 31 | 50.21 | 69 | 28 | NA | NA | NA | NA | NA | NA |
| 43 | ±1% | 1.6 | 53 | 29 | 56.98 | 66 | 29 | NA | NA | NA | NA | NA | NA |
| 47 | ±1% | 1.6 | 50 | 28 | 63.75 | 63 | 30 | NA | NA | NA | NA | NA | NA |
| 51 | ±1% | 1.6 | 48 | 26 | 70.53 | 60 | 31 | NA | NA | NA | NA | NA | NA |
| 56 | ±1% | 1.6 | 44 | 24 | 78.99 | 56 | 33 | NA | NA | NA | NA | NA | NA |
| 58 | ±1% | 1.6 | 42 | 23 | 83.54 | 54 | 34 | NA | NA | NA | NA | NA | NA |
| 68 | ±1% | 1.6 | 32 | 18 | 106.28 | 42 | 40 | NA | NA | NA | NA | NA | NA |



0603 Typical Electrical Tables

1

| Capacitance @ 1MHz and Tolerance | | Self Resonance Frequency (GHz) Typ. | Q Standard Value @ 1GHz | | Frequency 900MHz | | | Frequency 1900MHz | | | Frequency 2400MHz | | |
|----------------------------------|-------|-------------------------------------|-------------------------|------|------------------|--------|-----------------|-------------------|--------|-----------------|-------------------|--------|-----------------|
| C (pF) | Tol. | | Typ. | Min. | C(eff) (pF) Typ. | Q Typ. | ESR (mOhm) Typ. | C(eff) (pF) Typ. | Q Typ. | ESR (mOhm) Typ. | C(eff) (pF) Typ. | Q Typ. | ESR (mOhm) Typ. |
| 0.05 | ±0.02 | 25.6 | 1200 | 660 | 0.06 | 1333 | 945 | 0.06 | 556 | 832 | 0.06 | 397 | 880 |
| 0.1 | ±0.02 | 18.1 | 1156 | 636 | 0.11 | 1284 | 675 | 0.11 | 535 | 628 | 0.11 | 382 | 667 |
| 0.15 | ±0.02 | 14.8 | 1111 | 611 | 0.16 | 1235 | 555 | 0.16 | 514 | 533 | 0.16 | 367 | 567 |
| 0.2 | ±0.02 | 12.8 | 1067 | 587 | 0.21 | 1185 | 483 | 0.21 | 494 | 474 | 0.22 | 353 | 505 |
| 0.25 | ±0.02 | 11.4 | 1022 | 562 | 0.26 | 1136 | 433 | 0.27 | 473 | 433 | 0.27 | 338 | 462 |
| 0.3 | ±0.02 | 10.4 | 978 | 538 | 0.31 | 1086 | 397 | 0.32 | 453 | 402 | 0.32 | 323 | 430 |
| 0.35 | ±0.02 | 9.7 | 933 | 513 | 0.36 | 1037 | 368 | 0.37 | 432 | 378 | 0.37 | 309 | 404 |
| 0.4 | ±0.02 | 9.0 | 889 | 489 | 0.41 | 988 | 345 | 0.42 | 412 | 358 | 0.42 | 294 | 383 |
| 0.45 | ±0.02 | 8.5 | 844 | 464 | 0.46 | 938 | 326 | 0.47 | 391 | 341 | 0.48 | 279 | 365 |
| 0.5 | ±0.02 | 8.1 | 800 | 440 | 0.51 | 889 | 310 | 0.52 | 370 | 327 | 0.53 | 265 | 350 |
| 0.55 | ±0.02 | 7.7 | 788 | 434 | 0.57 | 875 | 296 | 0.57 | 363 | 315 | 0.58 | 261 | 337 |
| 0.6 | ±0.02 | 7.4 | 777 | 427 | 0.62 | 860 | 283 | 0.62 | 356 | 304 | 0.63 | 258 | 326 |
| 0.65 | ±0.02 | 7.1 | 765 | 421 | 0.67 | 846 | 273 | 0.67 | 348 | 294 | 0.68 | 255 | 315 |
| 0.7 | ±0.02 | 6.8 | 754 | 414 | 0.72 | 832 | 263 | 0.72 | 341 | 285 | 0.73 | 252 | 306 |
| 0.75 | ±0.02 | 6.6 | 742 | 408 | 0.77 | 817 | 254 | 0.78 | 334 | 277 | 0.79 | 248 | 298 |
| 0.8 | ±0.02 | 6.4 | 730 | 402 | 0.82 | 803 | 247 | 0.83 | 326 | 270 | 0.84 | 245 | 290 |
| 0.85 | ±0.02 | 6.2 | 719 | 395 | 0.87 | 789 | 239 | 0.88 | 319 | 264 | 0.89 | 242 | 283 |
| 0.9 | ±0.02 | 6.0 | 707 | 389 | 0.92 | 775 | 233 | 0.93 | 312 | 258 | 0.95 | 239 | 277 |
| 0.95 | ±0.02 | 5.9 | 696 | 383 | 0.97 | 760 | 227 | 0.98 | 304 | 252 | 1.00 | 235 | 271 |
| 1 | ±0.02 | 5.7 | 684 | 376 | 1.019 | 746 | 216 | 1.061 | 297 | 242 | 1.101 | 232 | 260 |
| 1.05 | ±0.02 | 5.6 | 667 | 367 | 1.076 | 731 | 213 | 1.126 | 290 | 239 | 1.171 | 226 | 256 |
| 1.1 | ±0.02 | 5.4 | 649 | 357 | 1.134 | 717 | 210 | 1.190 | 282 | 236 | 1.241 | 220 | 253 |
| 1.15 | ±0.02 | 5.3 | 632 | 347 | 1.192 | 702 | 206 | 1.254 | 275 | 233 | 1.311 | 214 | 250 |
| 1.2 | ±0.02 | 5.2 | 614 | 338 | 1.250 | 687 | 203 | 1.318 | 267 | 230 | 1.381 | 209 | 247 |
| 1.25 | ±0.02 | 5.1 | 605 | 333 | 1.307 | 677 | 200 | 1.382 | 262 | 227 | 1.451 | 203 | 244 |
| 1.3 | ±0.02 | 5.0 | 596 | 328 | 1.365 | 667 | 197 | 1.446 | 257 | 224 | 1.521 | 197 | 241 |
| 1.35 | ±0.02 | 4.9 | 587 | 323 | 1.423 | 658 | 194 | 1.511 | 252 | 221 | 1.591 | 191 | 238 |
| 1.4 | ±0.02 | 4.8 | 578 | 318 | 1.481 | 648 | 190 | 1.575 | 247 | 218 | 1.661 | 185 | 235 |
| 1.45 | ±0.02 | 4.8 | 569 | 313 | 1.538 | 638 | 187 | 1.639 | 242 | 215 | 1.731 | 179 | 232 |
| 1.5 | ±0.02 | 4.7 | 560 | 308 | 1.596 | 628 | 184 | 1.703 | 237 | 212 | 1.801 | 173 | 229 |
| 1.55 | ±0.02 | 4.6 | 551 | 303 | 1.645 | 620 | 181 | 1.760 | 233 | 209 | 1.866 | 170 | 226 |
| 1.6 | ±0.02 | 4.5 | 542 | 298 | 1.694 | 611 | 178 | 1.817 | 228 | 206 | 1.930 | 166 | 222 |
| 1.65 | ±0.02 | 4.5 | 534 | 293 | 1.743 | 603 | 175 | 1.874 | 224 | 203 | 1.995 | 163 | 219 |
| 1.7 | ±0.02 | 4.4 | 525 | 289 | 1.792 | 595 | 172 | 1.931 | 219 | 200 | 2.060 | 159 | 216 |
| 1.75 | ±0.02 | 4.3 | 516 | 284 | 1.841 | 587 | 169 | 1.988 | 215 | 197 | 2.124 | 156 | 213 |
| 1.8 | ±0.02 | 4.2 | 507 | 279 | 1.890 | 578 | 166 | 2.045 | 211 | 194 | 2.189 | 153 | 209 |
| 1.85 | ±0.02 | 4.2 | 498 | 274 | 1.939 | 570 | 163 | 2.102 | 206 | 191 | 2.253 | 149 | 206 |
| 1.9 | ±0.02 | 4.1 | 490 | 269 | 1.988 | 562 | 160 | 2.158 | 202 | 188 | 2.318 | 146 | 203 |
| 1.95 | ±0.02 | 4.1 | 481 | 264 | 2.037 | 553 | 157 | 2.215 | 197 | 185 | 2.383 | 142 | 199 |
| 2 | ±0.03 | 4.0 | 472 | 260 | 2.086 | 545 | 154 | 2.272 | 193 | 182 | 2.447 | 139 | 196 |
| 2.1 | ±0.03 | 3.9 | 462 | 254 | 2.190 | 535 | 151 | 2.402 | 187 | 180 | 2.604 | 134 | 193 |
| 2.2 | ±0.03 | 3.8 | 452 | 249 | 2.295 | 524 | 148 | 2.532 | 181 | 177 | 2.761 | 129 | 191 |
| 2.3 | ±0.03 | 3.8 | 442 | 243 | 2.400 | 514 | 145 | 2.662 | 175 | 175 | 2.917 | 124 | 188 |
| 2.4 | ±0.03 | 3.7 | 433 | 238 | 2.504 | 503 | 143 | 2.793 | 168 | 172 | 3.074 | 118 | 186 |
| 2.5 | ±0.03 | 3.6 | 423 | 232 | 2.609 | 493 | 140 | 2.923 | 162 | 170 | 3.230 | 113 | 183 |
| 2.6 | ±0.03 | 3.6 | 413 | 227 | 2.714 | 482 | 137 | 3.053 | 156 | 167 | 3.387 | 108 | 181 |
| 2.7 | ±0.03 | 3.5 | 403 | 222 | 2.818 | 472 | 134 | 3.183 | 150 | 165 | 3.543 | 103 | 178 |
| 2.8 | ±0.03 | 3.4 | 395 | 217 | 2.933 | 463 | 133 | 3.336 | 147 | 164 | 3.742 | 100 | 177 |
| 2.9 | ±0.03 | 3.4 | 388 | 213 | 3.047 | 453 | 131 | 3.489 | 144 | 162 | 3.940 | 97 | 175 |
| 3 | ±0.03 | 3.3 | 380 | 209 | 3.162 | 444 | 130 | 3.642 | 140 | 161 | 4.139 | 95 | 174 |
| 3.1 | ±0.05 | 3.2 | 372 | 205 | 3.276 | 435 | 129 | 3.795 | 137 | 160 | 4.337 | 92 | 172 |
| 3.2 | ±0.05 | 3.2 | 365 | 201 | 3.391 | 425 | 127 | 3.947 | 134 | 159 | 4.536 | 89 | 171 |
| 3.3 | ±0.05 | 3.1 | 357 | 196 | 3.506 | 416 | 126 | 4.100 | 131 | 157 | 4.734 | 86 | 169 |
| 3.4 | ±0.05 | 3.1 | 349 | 192 | 3.620 | 407 | 125 | 4.253 | 128 | 156 | 4.933 | 84 | 168 |
| 3.5 | ±0.05 | 3.1 | 342 | 188 | 3.735 | 397 | 123 | 4.406 | 125 | 155 | 5.131 | 81 | 166 |
| 3.6 | ±0.05 | 3.0 | 334 | 184 | 3.849 | 388 | 122 | 4.559 | 121 | 154 | 5.330 | 78 | 165 |
| 3.7 | ±0.05 | 3.0 | 326 | 179 | 3.964 | 379 | 121 | 4.712 | 118 | 152 | 5.528 | 75 | 164 |
| 3.8 | ±0.05 | 3.0 | 318 | 175 | 4.078 | 369 | 119 | 4.865 | 115 | 151 | 5.727 | 73 | 162 |
| 3.9 | ±0.05 | 2.9 | 311 | 171 | 4.193 | 360 | 118 | 5.018 | 112 | 150 | 5.925 | 70 | 161 |

0603 Typical Electrical Tables

| Capacitance @ 1MHz and Tolerance | | Self Resonance Frequency (GHz) Typ. | Q Standard Value @ 1GHz | | Frequency 900MHz | | | Frequency 1900MHz | | | Frequency 2400MHz | | |
|----------------------------------|-------|-------------------------------------|-------------------------|------|------------------|--------|-----------------|-------------------|--------|-----------------|-------------------|--------|-----------------|
| C (pF) | Tol. | | Typ. | Min. | C(eff) (pF) Typ. | Q Typ. | ESR (mOhm) Typ. | C(eff) (pF) Typ. | Q Typ. | ESR (mOhm) Typ. | C(eff) (pF) Typ. | Q Typ. | ESR (mOhm) Typ. |
| 4 | ±0.05 | 2.9 | 307 | 169 | 4.301 | 355 | 117 | 5.188 | 110 | 149 | 6.188 | 68 | 160 |
| 4.1 | ±0.05 | 2.8 | 303 | 167 | 4.410 | 351 | 116 | 5.358 | 108 | 148 | 6.450 | 67 | 159 |
| 4.2 | ±0.05 | 2.8 | 299 | 164 | 4.518 | 347 | 116 | 5.528 | 106 | 148 | 6.713 | 65 | 158 |
| 4.3 | ±0.05 | 2.7 | 295 | 162 | 4.627 | 342 | 115 | 5.698 | 104 | 147 | 6.975 | 64 | 157 |
| 4.4 | ±0.05 | 2.7 | 291 | 160 | 4.735 | 338 | 114 | 5.867 | 102 | 146 | 7.238 | 62 | 157 |
| 4.5 | ±0.05 | 2.7 | 287 | 158 | 4.843 | 333 | 113 | 6.037 | 100 | 146 | 7.500 | 61 | 156 |
| 4.6 | ±0.05 | 2.6 | 283 | 156 | 4.952 | 329 | 112 | 6.207 | 98 | 145 | 7.763 | 59 | 155 |
| 4.7 | ±0.05 | 2.6 | 279 | 154 | 5.060 | 324 | 112 | 6.377 | 96 | 144 | 8.025 | 58 | 154 |
| 5.1 | ±0.05 | 2.5 | 263 | 145 | 5.494 | 307 | 109 | 7.057 | 88 | 142 | 9.075 | 52 | 151 |
| 5.6 | ±0.05 | 2.4 | 244 | 134 | 6.035 | 285 | 105 | 7.906 | 78 | 138 | 10.39 | 44 | 147 |
| 6.2 | ±0.1 | 2.3 | 228 | 126 | 6.865 | 267 | 102 | 9.517 | 72 | 133 | 13.66 | 40 | 141 |
| 6.8 | ±0.1 | 2.2 | 213 | 117 | 7.694 | 250 | 100 | 11.13 | 66 | 128 | 16.93 | 35 | 135 |
| 7.5 | ±0.1 | 2.1 | 195 | 107 | 8.367 | 227 | 98 | 12.63 | 57 | 125 | 20.91 | 28 | 132 |
| 8.2 | ±0.1 | 2.0 | 176 | 97 | 9.041 | 205 | 96 | 14.14 | 49 | 123 | 24.88 | 21 | 129 |
| 9.1 | ±0.1 | 1.9 | 161 | 89 | 10.20 | 188 | 96 | 18.09 | 42 | 122 | 40.00 | 16 | 128 |
| 10 | ±1% | 1.8 | 146 | 80 | 11.37 | 171 | 95 | 22.05 | 36 | 121 | 70.00 | 12 | 127 |
| 11 | ±1% | 1.7 | 129 | 71 | 12.66 | 153 | 95 | 26.44 | 29 | 120 | 140.0 | 6 | 126 |
| 12 | ±1% | 1.6 | 112 | 62 | 13.95 | 134 | 94 | 30.83 | 22 | 119 | 231.3 | 1 | 125 |
| 13 | ±1% | 1.6 | 102 | 56 | 15.31 | 122 | 93 | 40.37 | 18 | 118 | n/a | n/a | n/a |
| 14 | ±1% | 1.5 | 92 | 51 | 16.67 | 111 | 92 | 49.91 | 15 | 118 | n/a | n/a | n/a |
| 15 | ±1% | 1.5 | 82 | 45 | 18.03 | 99 | 90 | 59.44 | 11 | 117 | n/a | n/a | n/a |
| 16 | ±1% | 1.4 | 79 | 43 | 19.61 | 96 | 90 | 80.00 | 8 | 117 | n/a | n/a | n/a |
| 17 | ±1% | 1.4 | 76 | 42 | 21.18 | 92 | 90 | 120.0 | 6 | 116 | n/a | n/a | n/a |
| 18 | ±1% | 1.3 | 73 | 40 | 22.76 | 89 | 90 | 190.0 | 4 | 116 | n/a | n/a | n/a |
| 19 | ±1% | 1.3 | 69 | 38 | 24.37 | 84 | 89 | n/a | n/a | n/a | n/a | n/a | n/a |
| 20 | ±1% | 1.2 | 65 | 36 | 25.98 | 80 | 89 | n/a | n/a | n/a | n/a | n/a | n/a |
| 22 | ±1% | 1.2 | 57 | 31 | 29.21 | 72 | 87 | n/a | n/a | n/a | n/a | n/a | n/a |
| 24 | ±1% | 1.2 | 48 | 26 | 34.44 | 62 | 87 | n/a | n/a | n/a | n/a | n/a | n/a |
| 27 | ±1% | 1.1 | 43 | 24 | 41.87 | 56 | 86 | n/a | n/a | n/a | n/a | n/a | n/a |
| 30 | ±1% | 1.0 | 37 | 21 | 49.29 | 49 | 85 | n/a | n/a | n/a | n/a | n/a | n/a |
| 33 | ±1% | 1.0 | 32 | 18 | 56.72 | 43 | 84 | n/a | n/a | n/a | n/a | n/a | n/a |
| 36 | ±1% | 1.0 | 27 | 15 | 64.15 | 37 | 83 | n/a | n/a | n/a | n/a | n/a | n/a |
| 39 | ±1% | 1.0 | 21 | 12 | 71.57 | 30 | 82 | n/a | n/a | n/a | n/a | n/a | n/a |



0805 Typical Electrical Tables

1

| Capacitance @ 1MHz and Tolerance | | Self Resonance Frequency (GHz) Typ. | Q Standard Value @ 1GHz | | Frequency 900MHz | | | Frequency 1900MHz | | | Frequency 2400MHz | | |
|----------------------------------|-------|-------------------------------------|-------------------------|------|------------------|--------|-----------------|-------------------|--------|-----------------|-------------------|--------|-----------------|
| C (pF) | Tol. | | Typ. | Min. | C(eff) (pF) Typ. | Q Typ. | ESR (mOhm) Typ. | C(eff) (pF) Typ. | Q Typ. | ESR (mOhm) Typ. | C(eff) (pF) Typ. | Q Typ. | ESR (mOhm) Typ. |
| 0.1 | ±0.02 | 17.2 | 880 | 484 | 0.125 | 890 | 3296 | 0.125 | 545 | 2417 | 0.126 | 447 | 2265 |
| 0.15 | ±0.02 | 14.1 | 872 | 480 | 0.176 | 885 | 2073 | 0.178 | 530 | 1626 | 0.181 | 434 | 1546 |
| 0.2 | ±0.02 | 12.3 | 864 | 475 | 0.228 | 880 | 1492 | 0.231 | 516 | 1227 | 0.235 | 420 | 1178 |
| 0.25 | ±0.02 | 11.0 | 857 | 471 | 0.279 | 874 | 1156 | 0.284 | 501 | 986 | 0.290 | 407 | 955 |
| 0.3 | ±0.02 | 10.1 | 849 | 467 | 0.331 | 869 | 938 | 0.337 | 487 | 825 | 0.344 | 394 | 804 |
| 0.35 | ±0.02 | 9.4 | 841 | 462 | 0.382 | 864 | 787 | 0.390 | 472 | 710 | 0.399 | 380 | 695 |
| 0.4 | ±0.02 | 8.8 | 833 | 458 | 0.433 | 859 | 675 | 0.443 | 458 | 623 | 0.453 | 367 | 613 |
| 0.45 | ±0.02 | 8.3 | 825 | 454 | 0.485 | 853 | 590 | 0.496 | 443 | 555 | 0.508 | 353 | 549 |
| 0.5 | ±0.02 | 7.9 | 817 | 450 | 0.536 | 848 | 523 | 0.549 | 429 | 501 | 0.562 | 340 | 497 |
| 0.55 | ±0.02 | 7.5 | 811 | 446 | 0.584 | 843 | 469 | 0.600 | 420 | 456 | 0.616 | 331 | 454 |
| 0.6 | ±0.02 | 7.2 | 805 | 443 | 0.631 | 838 | 425 | 0.651 | 411 | 419 | 0.670 | 322 | 418 |
| 0.65 | ±0.02 | 6.9 | 798 | 439 | 0.679 | 834 | 387 | 0.702 | 402 | 387 | 0.724 | 313 | 388 |
| 0.7 | ±0.02 | 6.7 | 792 | 436 | 0.726 | 829 | 356 | 0.753 | 393 | 360 | 0.778 | 304 | 362 |
| 0.75 | ±0.02 | 6.5 | 786 | 432 | 0.774 | 824 | 329 | 0.804 | 384 | 337 | 0.832 | 295 | 339 |
| 0.8 | ±0.02 | 6.3 | 779 | 429 | 0.822 | 819 | 306 | 0.855 | 375 | 316 | 0.886 | 286 | 319 |
| 0.85 | ±0.02 | 6.1 | 773 | 425 | 0.869 | 814 | 285 | 0.906 | 366 | 298 | 0.940 | 277 | 301 |
| 0.9 | ±0.02 | 5.9 | 767 | 422 | 0.917 | 810 | 267 | 0.957 | 357 | 282 | 0.994 | 268 | 285 |
| 0.95 | ±0.02 | 5.8 | 760 | 418 | 0.964 | 805 | 251 | 1.008 | 348 | 267 | 1.049 | 260 | 271 |
| 1 | ±0.02 | 5.6 | 754 | 415 | 1.012 | 800 | 231 | 1.059 | 339 | 235 | 1.103 | 251 | 242 |
| 1.05 | ±0.02 | 5.5 | 747 | 411 | 1.065 | 794 | 223 | 1.120 | 335 | 228 | 1.170 | 247 | 235 |
| 1.1 | ±0.02 | 5.4 | 740 | 407 | 1.119 | 788 | 215 | 1.181 | 330 | 221 | 1.237 | 244 | 228 |
| 1.15 | ±0.02 | 5.3 | 732 | 403 | 1.172 | 782 | 208 | 1.242 | 326 | 214 | 1.304 | 240 | 220 |
| 1.2 | ±0.02 | 5.1 | 725 | 399 | 1.225 | 776 | 200 | 1.304 | 322 | 207 | 1.371 | 237 | 213 |
| 1.25 | ±0.02 | 5.0 | 718 | 395 | 1.279 | 770 | 192 | 1.365 | 318 | 200 | 1.438 | 233 | 206 |
| 1.3 | ±0.02 | 4.9 | 711 | 391 | 1.332 | 764 | 184 | 1.426 | 313 | 193 | 1.505 | 230 | 199 |
| 1.35 | ±0.02 | 4.9 | 704 | 387 | 1.386 | 758 | 176 | 1.487 | 309 | 186 | 1.573 | 226 | 192 |
| 1.4 | ±0.02 | 4.8 | 696 | 383 | 1.439 | 752 | 169 | 1.548 | 305 | 179 | 1.640 | 223 | 184 |
| 1.45 | ±0.02 | 4.7 | 689 | 379 | 1.492 | 746 | 161 | 1.609 | 300 | 172 | 1.707 | 219 | 177 |
| 1.5 | ±0.02 | 4.6 | 682 | 375 | 1.546 | 740 | 153 | 1.670 | 296 | 165 | 1.774 | 216 | 170 |
| 1.55 | ±0.02 | 4.6 | 675 | 371 | 1.600 | 733 | 151 | 1.734 | 292 | 163 | 1.850 | 212 | 168 |
| 1.6 | ±0.02 | 4.5 | 668 | 367 | 1.654 | 726 | 148 | 1.799 | 287 | 161 | 1.927 | 208 | 165 |
| 1.65 | ±0.02 | 4.4 | 660 | 363 | 1.708 | 719 | 146 | 1.864 | 283 | 159 | 2.003 | 204 | 163 |
| 1.7 | ±0.02 | 4.3 | 653 | 359 | 1.762 | 712 | 143 | 1.928 | 278 | 157 | 2.079 | 200 | 160 |
| 1.75 | ±0.02 | 4.3 | 646 | 355 | 1.816 | 705 | 141 | 1.993 | 274 | 155 | 2.156 | 197 | 158 |
| 1.8 | ±0.02 | 4.2 | 639 | 351 | 1.870 | 698 | 139 | 2.058 | 269 | 152 | 2.232 | 193 | 155 |
| 1.85 | ±0.02 | 4.2 | 632 | 347 | 1.924 | 691 | 136 | 2.122 | 265 | 150 | 2.308 | 189 | 153 |
| 1.9 | ±0.02 | 4.1 | 624 | 343 | 1.978 | 684 | 134 | 2.187 | 260 | 148 | 2.385 | 185 | 150 |
| 1.95 | ±0.02 | 4.1 | 617 | 339 | 2.033 | 677 | 131 | 2.252 | 256 | 146 | 2.461 | 181 | 148 |
| 2 | ±0.03 | 4.0 | 610 | 336 | 2.087 | 670 | 129 | 2.316 | 251 | 144 | 2.537 | 177 | 145 |
| 2.1 | ±0.03 | 3.9 | 597 | 328 | 2.183 | 658 | 127 | 2.440 | 245 | 142 | 2.690 | 171 | 143 |
| 2.2 | ±0.03 | 3.8 | 584 | 321 | 2.280 | 646 | 124 | 2.563 | 239 | 139 | 2.843 | 165 | 141 |
| 2.3 | ±0.03 | 3.8 | 571 | 314 | 2.377 | 634 | 122 | 2.687 | 233 | 137 | 2.996 | 159 | 139 |
| 2.4 | ±0.03 | 3.6 | 557 | 307 | 2.474 | 623 | 119 | 2.810 | 227 | 135 | 3.149 | 154 | 136 |
| 2.5 | ±0.03 | 3.6 | 544 | 299 | 2.571 | 611 | 117 | 2.934 | 221 | 133 | 3.301 | 148 | 134 |
| 2.6 | ±0.03 | 3.6 | 531 | 292 | 2.668 | 599 | 114 | 3.057 | 215 | 130 | 3.454 | 142 | 132 |
| 2.7 | ±0.03 | 3.4 | 518 | 285 | 2.764 | 587 | 112 | 3.181 | 209 | 128 | 3.607 | 136 | 130 |
| 2.8 | ±0.03 | 3.4 | 507 | 279 | 2.875 | 575 | 111 | 3.348 | 204 | 127 | 3.850 | 132 | 129 |
| 2.9 | ±0.03 | 3.4 | 497 | 273 | 2.987 | 564 | 110 | 3.514 | 199 | 125 | 4.093 | 129 | 127 |
| 3 | ±0.03 | 3.3 | 486 | 267 | 3.098 | 552 | 109 | 3.681 | 194 | 124 | 4.335 | 125 | 126 |
| 3.1 | ±0.05 | 3.3 | 475 | 261 | 3.209 | 540 | 108 | 3.848 | 189 | 123 | 4.578 | 121 | 125 |
| 3.2 | ±0.05 | 3.2 | 465 | 256 | 3.320 | 528 | 107 | 4.014 | 183 | 122 | 4.821 | 118 | 123 |
| 3.3 | ±0.05 | 3.1 | 454 | 250 | 3.431 | 517 | 106 | 4.181 | 178 | 120 | 5.064 | 114 | 122 |
| 3.4 | ±0.05 | 3.1 | 443 | 244 | 3.542 | 505 | 105 | 4.348 | 173 | 119 | 5.307 | 110 | 121 |
| 3.5 | ±0.05 | 3.1 | 433 | 238 | 3.653 | 493 | 104 | 4.515 | 168 | 118 | 5.549 | 107 | 119 |
| 3.6 | ±0.05 | 3.0 | 422 | 232 | 3.764 | 481 | 103 | 4.681 | 163 | 116 | 5.792 | 103 | 118 |
| 3.7 | ±0.05 | 3.0 | 412 | 226 | 3.875 | 470 | 102 | 4.848 | 158 | 115 | 6.035 | 99 | 116 |
| 3.8 | ±0.05 | 3.0 | 401 | 220 | 3.986 | 458 | 101 | 5.015 | 153 | 114 | 6.278 | 96 | 115 |
| 3.9 | ±0.05 | 2.9 | 390 | 215 | 4.097 | 446 | 100 | 5.182 | 148 | 113 | 6.521 | 92 | 114 |

0805 Typical Electrical Tables

| Capacitance @ 1MHz and Tolerance | | Self Resonance Frequency (GHz) Typ. | Q Standard Value @ 1GHz | | Frequency 900MHz | | | Frequency 1900MHz | | | Frequency 2400MHz | | |
|----------------------------------|-------|-------------------------------------|-------------------------|------|------------------|--------|-----------------|-------------------|--------|-----------------|-------------------|--------|-----------------|
| C (pF) | Tol. | | Typ. | Min. | C(eff) (pF) Typ. | Q Typ. | ESR (mOhm) Typ. | C(eff) (pF) Typ. | Q Typ. | ESR (mOhm) Typ. | C(eff) (pF) Typ. | Q Typ. | ESR (mOhm) Typ. |
| 4 | ±0.05 | 2.9 | 384 | 211 | 4.214 | 440 | 99 | 5.378 | 144 | 112 | 6.861 | 89 | 113 |
| 4.1 | ±0.05 | 2.9 | 378 | 208 | 4.331 | 434 | 98 | 5.574 | 141 | 112 | 7.201 | 86 | 113 |
| 4.2 | ±0.05 | 2.8 | 372 | 205 | 4.448 | 428 | 98 | 5.769 | 138 | 111 | 7.541 | 84 | 112 |
| 4.3 | ±0.05 | 2.7 | 366 | 202 | 4.564 | 422 | 97 | 5.965 | 134 | 111 | 7.881 | 81 | 111 |
| 4.4 | ±0.05 | 2.7 | 360 | 198 | 4.681 | 415 | 96 | 6.161 | 131 | 110 | 8.222 | 78 | 111 |
| 4.5 | ±0.05 | 2.7 | 355 | 195 | 4.798 | 409 | 96 | 6.357 | 128 | 110 | 8.562 | 75 | 110 |
| 4.6 | ±0.05 | 2.7 | 349 | 192 | 4.915 | 403 | 95 | 6.553 | 124 | 109 | 8.902 | 72 | 110 |
| 4.7 | ±0.05 | 2.6 | 343 | 188 | 5.032 | 397 | 94 | 6.749 | 121 | 109 | 9.242 | 69 | 109 |
| 5.1 | ±0.05 | 2.5 | 319 | 175 | 5.499 | 373 | 91 | 7.533 | 108 | 107 | 10.60 | 58 | 107 |
| 5.6 | ±0.05 | 2.4 | 289 | 159 | 6.083 | 342 | 88 | 8.513 | 91 | 104 | 12.30 | 44 | 104 |
| 6.2 | ±0.1 | 2.3 | 264 | 145 | 6.842 | 313 | 86 | 10.43 | 79 | 102 | 18.03 | 36 | 103 |
| 6.8 | ±0.1 | 2.2 | 239 | 131 | 7.601 | 283 | 84 | 12.35 | 68 | 101 | 23.76 | 28 | 102 |
| 7.5 | ±0.1 | 2.1 | 218 | 120 | 8.468 | 259 | 83 | 14.84 | 61 | 100 | 37.25 | 21 | 101 |
| 8.2 | ±0.1 | 2.0 | 198 | 109 | 9.334 | 234 | 82 | 17.32 | 55 | 100 | 50.74 | 15 | 100 |
| 9.1 | ±0.1 | 1.9 | 179 | 99 | 10.57 | 213 | 82 | 24.90 | 46 | 100 | n/a | n/a | n/a |
| 10 | ±1% | 1.8 | 160 | 88 | 11.80 | 191 | 81 | 32.48 | 37 | 100 | n/a | n/a | n/a |
| 11 | ±1% | 1.7 | 139 | 77 | 13.17 | 167 | 81 | 40.90 | 26 | 101 | n/a | n/a | n/a |
| 12 | ±1% | 1.6 | 119 | 65 | 14.54 | 143 | 80 | 49.32 | 16 | 101 | n/a | n/a | n/a |
| 13 | ±1% | 1.6 | 110 | 60 | 16.17 | 134 | 80 | n/a | n/a | n/a | n/a | n/a | n/a |
| 14 | ±1% | 1.5 | 101 | 55 | 17.79 | 125 | 80 | n/a | n/a | n/a | n/a | n/a | n/a |
| 15 | ±1% | 1.5 | 92 | 51 | 19.42 | 116 | 80 | n/a | n/a | n/a | n/a | n/a | n/a |
| 16 | ±1% | 1.4 | 87 | 48 | 21.13 | 110 | 79 | n/a | n/a | n/a | n/a | n/a | n/a |
| 17 | ±1% | 1.4 | 83 | 46 | 22.85 | 104 | 78 | n/a | n/a | n/a | n/a | n/a | n/a |
| 18 | ±1% | 1.3 | 78 | 43 | 24.57 | 99 | 77 | n/a | n/a | n/a | n/a | n/a | n/a |
| 19 | ±1% | 1.3 | 73 | 40 | 26.41 | 92 | 77 | n/a | n/a | n/a | n/a | n/a | n/a |
| 20 | ±1% | 1.3 | 67 | 37 | 28.26 | 85 | 76 | n/a | n/a | n/a | n/a | n/a | n/a |
| 22 | ±1% | 1.2 | 57 | 31 | 31.95 | 72 | 76 | n/a | n/a | n/a | n/a | n/a | n/a |
| 24 | ±1% | 1.2 | 46 | 25 | 35.64 | 59 | 75 | n/a | n/a | n/a | n/a | n/a | n/a |
| 27 | ±1% | 1.1 | 41 | 22 | 44.94 | 54 | 74 | n/a | n/a | n/a | n/a | n/a | n/a |
| 30 | ±1% | 1.0 | 36 | 20 | 54.24 | 48 | 73 | n/a | n/a | n/a | n/a | n/a | n/a |
| 33 | ±1% | 1.0 | 30 | 17 | 63.54 | 42 | 72 | n/a | n/a | n/a | n/a | n/a | n/a |
| 36 | ±1% | 0.9 | 25 | 14 | 72.84 | 37 | 71 | n/a | n/a | n/a | n/a | n/a | n/a |
| 39 | ±1% | 0.9 | 20 | 11 | 82.14 | 31 | 70 | n/a | n/a | n/a | n/a | n/a | n/a |
| 43 | ±1% | 0.9 | 16 | 9 | 102.9 | 27 | 66 | n/a | n/a | n/a | n/a | n/a | n/a |
| 47 | ±1% | 0.8 | 12 | 7 | 123.7 | 23 | 63 | n/a | n/a | n/a | n/a | n/a | n/a |



1210 Typical Electrical Tables

1

| Capacitance @ 1MHz and Tolerance | | Self Resonance Frequency (GHz) Typ. | Q Standard Value @ 1GHz | | Frequency 900MHz | | | Frequency 1900MHz | | | Frequency 2400MHz | | |
|----------------------------------|-------|-------------------------------------|-------------------------|------|------------------|--------|-----------------|-------------------|--------|-----------------|-------------------|--------|-----------------|
| C (pF) | Tol. | | Typ. | Min. | C(eff) (pF) Typ. | Q Typ. | ESR (mOhm) Typ. | C(eff) (pF) Typ. | Q Typ. | ESR (mOhm) Typ. | C(eff) (pF) Typ. | Q Typ. | ESR (mOhm) Typ. |
| 0.1 | ±0.02 | 15.6 | 1190 | 654 | 0.136 | 1176 | 3633 | 0.136 | 606 | 2149 | 0.136 | 450 | 2068 |
| 0.15 | ±0.03 | 12.7 | 1179 | 648 | 0.190 | 1166 | 2129 | 0.190 | 597 | 1407 | 0.191 | 444 | 1370 |
| 0.2 | ±0.02 | 11.0 | 1168 | 642 | 0.244 | 1156 | 1457 | 0.244 | 589 | 1042 | 0.246 | 438 | 1023 |
| 0.25 | ±0.02 | 9.8 | 1156 | 636 | 0.297 | 1145 | 1086 | 0.299 | 581 | 826 | 0.301 | 432 | 816 |
| 0.3 | ±0.02 | 8.9 | 1145 | 630 | 0.351 | 1135 | 854 | 0.353 | 573 | 683 | 0.356 | 426 | 678 |
| 0.35 | ±0.02 | 8.3 | 1134 | 624 | 0.405 | 1125 | 697 | 0.408 | 565 | 581 | 0.411 | 421 | 580 |
| 0.4 | ±0.02 | 7.7 | 1123 | 618 | 0.459 | 1115 | 584 | 0.462 | 557 | 505 | 0.466 | 415 | 506 |
| 0.45 | ±0.02 | 7.3 | 1112 | 612 | 0.513 | 1105 | 500 | 0.516 | 549 | 447 | 0.521 | 409 | 449 |
| 0.5 | ±0.02 | 6.9 | 1101 | 606 | 0.567 | 1095 | 435 | 0.571 | 541 | 400 | 0.576 | 403 | 404 |
| 0.55 | ±0.02 | 6.6 | 1090 | 599 | 0.617 | 1084 | 384 | 0.621 | 532 | 362 | 0.627 | 397 | 366 |
| 0.6 | ±0.02 | 6.3 | 1079 | 593 | 0.666 | 1074 | 342 | 0.672 | 524 | 331 | 0.679 | 391 | 335 |
| 0.65 | ±0.02 | 6.0 | 1068 | 587 | 0.716 | 1064 | 308 | 0.723 | 516 | 304 | 0.731 | 385 | 309 |
| 0.7 | ±0.02 | 5.8 | 1057 | 581 | 0.765 | 1054 | 279 | 0.774 | 508 | 282 | 0.783 | 379 | 287 |
| 0.75 | ±0.02 | 5.6 | 1046 | 575 | 0.815 | 1044 | 255 | 0.824 | 500 | 262 | 0.834 | 374 | 267 |
| 0.8 | ±0.02 | 5.4 | 1035 | 569 | 0.864 | 1034 | 234 | 0.875 | 492 | 245 | 0.886 | 368 | 250 |
| 0.85 | ±0.02 | 5.3 | 1023 | 563 | 0.914 | 1024 | 216 | 0.926 | 484 | 230 | 0.938 | 362 | 236 |
| 0.9 | ±0.02 | 5.1 | 1012 | 557 | 0.963 | 1013 | 201 | 0.976 | 476 | 217 | 0.989 | 356 | 222 |
| 0.95 | ±0.02 | 5.0 | 1001 | 551 | 1.013 | 1003 | 187 | 1.027 | 467 | 205 | 1.041 | 350 | 210 |
| 1 | ±0.02 | 5.0 | 992 | 546 | 1.062 | 983 | 167 | 1.078 | 459 | 170 | 1.093 | 344 | 177 |
| 1.05 | ±0.02 | 4.9 | 981 | 539 | 1.107 | 975 | 163 | 1.124 | 451 | 167 | 1.141 | 338 | 174 |
| 1.1 | ±0.02 | 4.8 | 969 | 533 | 1.152 | 966 | 158 | 1.170 | 443 | 165 | 1.189 | 331 | 172 |
| 1.15 | ±0.02 | 4.7 | 958 | 527 | 1.196 | 958 | 154 | 1.217 | 435 | 162 | 1.236 | 325 | 169 |
| 1.2 | ±0.02 | 4.6 | 946 | 521 | 1.241 | 950 | 150 | 1.263 | 427 | 160 | 1.284 | 318 | 167 |
| 1.25 | ±0.02 | 4.5 | 935 | 514 | 1.285 | 942 | 146 | 1.309 | 419 | 157 | 1.332 | 312 | 164 |
| 1.3 | ±0.02 | 4.4 | 923 | 508 | 1.330 | 933 | 142 | 1.355 | 410 | 155 | 1.380 | 305 | 162 |
| 1.35 | ±0.02 | 4.3 | 912 | 502 | 1.375 | 925 | 138 | 1.402 | 402 | 152 | 1.428 | 299 | 159 |
| 1.4 | ±0.02 | 4.2 | 900 | 495 | 1.419 | 917 | 134 | 1.448 | 394 | 150 | 1.476 | 293 | 156 |
| 1.45 | ±0.02 | 4.1 | 889 | 489 | 1.464 | 908 | 129 | 1.494 | 386 | 147 | 1.524 | 286 | 154 |
| 1.5 | ±0.02 | 4.1 | 877 | 483 | 1.508 | 900 | 125 | 1.541 | 378 | 144 | 1.572 | 280 | 151 |
| 1.55 | ±0.02 | 4.0 | 862 | 474 | 1.567 | 890 | 123 | 1.618 | 371 | 143 | 1.638 | 274 | 150 |
| 1.6 | ±0.02 | 3.9 | 846 | 465 | 1.626 | 881 | 122 | 1.694 | 363 | 142 | 1.704 | 268 | 149 |
| 1.65 | ±0.02 | 3.9 | 831 | 457 | 1.685 | 871 | 120 | 1.771 | 356 | 140 | 1.770 | 262 | 148 |
| 1.7 | ±0.02 | 3.8 | 815 | 448 | 1.743 | 862 | 118 | 1.848 | 349 | 139 | 1.836 | 256 | 147 |
| 1.75 | ±0.02 | 3.7 | 800 | 440 | 1.802 | 852 | 116 | 1.925 | 342 | 138 | 1.902 | 250 | 145 |
| 1.8 | ±0.02 | 3.7 | 784 | 431 | 1.861 | 843 | 114 | 2.002 | 334 | 136 | 1.968 | 244 | 144 |
| 1.85 | ±0.02 | 3.6 | 769 | 423 | 1.920 | 833 | 112 | 2.079 | 327 | 135 | 2.034 | 239 | 143 |
| 1.9 | ±0.02 | 3.5 | 753 | 414 | 1.978 | 824 | 110 | 2.156 | 320 | 134 | 2.100 | 233 | 142 |
| 1.95 | ±0.02 | 3.4 | 737 | 406 | 2.037 | 814 | 108 | 2.233 | 313 | 132 | 2.167 | 227 | 141 |
| 2 | ±0.03 | 3.3 | 722 | 397 | 2.096 | 805 | 107 | 2.310 | 305 | 131 | 2.233 | 221 | 139 |
| 2.1 | ±0.03 | 3.2 | 691 | 380 | 2.213 | 786 | 103 | 2.464 | 291 | 128 | 2.365 | 209 | 137 |
| 2.2 | ±0.03 | 3.0 | 660 | 363 | 2.331 | 767 | 99 | 2.618 | 276 | 126 | 2.497 | 198 | 135 |
| 2.3 | ±0.03 | 2.9 | 644 | 354 | 2.420 | 747 | 97 | 2.681 | 268 | 123 | 2.613 | 191 | 132 |
| 2.4 | ±0.03 | 2.9 | 629 | 346 | 2.508 | 728 | 96 | 2.744 | 259 | 121 | 2.729 | 185 | 130 |
| 2.5 | ±0.03 | 2.8 | 614 | 338 | 2.597 | 709 | 94 | 2.807 | 251 | 118 | 2.845 | 179 | 128 |
| 2.6 | ±0.03 | 2.8 | 598 | 329 | 2.686 | 689 | 93 | 2.870 | 242 | 116 | 2.961 | 173 | 126 |
| 2.7 | ±0.03 | 2.7 | 583 | 321 | 2.775 | 670 | 91 | 2.933 | 234 | 114 | 3.077 | 167 | 123 |
| 2.8 | ±0.03 | 2.7 | 574 | 316 | 2.875 | 659 | 90 | 3.047 | 230 | 113 | 3.205 | 164 | 122 |
| 2.9 | ±0.03 | 2.7 | 566 | 311 | 2.975 | 647 | 89 | 3.162 | 227 | 112 | 3.334 | 161 | 121 |
| 3 | ±0.03 | 2.7 | 557 | 306 | 3.075 | 636 | 88 | 3.276 | 223 | 111 | 3.462 | 157 | 121 |
| 3.1 | ±0.05 | 2.7 | 548 | 302 | 3.174 | 625 | 87 | 3.390 | 220 | 110 | 3.590 | 154 | 120 |
| 3.2 | ±0.05 | 2.6 | 540 | 297 | 3.274 | 613 | 87 | 3.504 | 216 | 109 | 3.718 | 151 | 119 |
| 3.3 | ±0.05 | 2.6 | 531 | 292 | 3.374 | 602 | 86 | 3.619 | 213 | 108 | 3.847 | 148 | 118 |
| 3.4 | ±0.05 | 2.6 | 522 | 287 | 3.474 | 591 | 85 | 3.733 | 209 | 107 | 3.975 | 145 | 117 |
| 3.5 | ±0.05 | 2.6 | 514 | 283 | 3.574 | 579 | 84 | 3.847 | 206 | 106 | 4.103 | 141 | 116 |
| 3.6 | ±0.05 | 2.5 | 505 | 278 | 3.674 | 568 | 83 | 3.961 | 202 | 105 | 4.231 | 138 | 115 |
| 3.7 | ±0.05 | 2.5 | 496 | 273 | 3.773 | 556 | 82 | 4.076 | 198 | 104 | 4.359 | 135 | 114 |
| 3.8 | ±0.05 | 2.5 | 488 | 268 | 3.873 | 545 | 81 | 4.190 | 195 | 103 | 4.488 | 132 | 113 |
| 3.9 | ±0.05 | 2.4 | 479 | 264 | 3.973 | 534 | 80 | 4.304 | 191 | 102 | 4.616 | 129 | 112 |

| Capacitance @ 1MHz and Tolerance | | Self Resonance Frequency (GHz) Typ. | Q Standard Value @ 1GHz | | Frequency 900MHz | | | Frequency 1900MHz | | | Frequency 2400MHz | | |
|----------------------------------|-------|-------------------------------------|-------------------------|------|------------------|--------|-----------------|-------------------|--------|-----------------|-------------------|--------|-----------------|
| C (pF) | Tol. | | Typ. | Min. | C(eff) (pF) Typ. | Q Typ. | ESR (mOhm) Typ. | C(eff) (pF) Typ. | Q Typ. | ESR (mOhm) Typ. | C(eff) (pF) Typ. | Q Typ. | ESR (mOhm) Typ. |
| 4 | ±0.05 | 2.4 | 473 | 260 | 4.083 | 528 | 79 | 4.435 | 189 | 101 | 4.768 | 127 | 112 |
| 4.1 | ±0.05 | 2.4 | 467 | 257 | 4.192 | 522 | 78 | 4.565 | 186 | 100 | 4.919 | 125 | 111 |
| 4.2 | ±0.05 | 2.4 | 462 | 254 | 4.302 | 516 | 78 | 4.695 | 183 | 100 | 5.071 | 123 | 110 |
| 4.3 | ±0.05 | 2.3 | 456 | 251 | 4.411 | 511 | 77 | 4.825 | 180 | 99 | 5.223 | 121 | 110 |
| 4.4 | ±0.05 | 2.3 | 450 | 247 | 4.521 | 505 | 76 | 4.956 | 178 | 98 | 5.375 | 119 | 109 |
| 4.5 | ±0.05 | 2.3 | 444 | 244 | 4.630 | 499 | 75 | 5.086 | 175 | 98 | 5.526 | 117 | 108 |
| 4.6 | ±0.05 | 2.3 | 438 | 241 | 4.740 | 493 | 75 | 5.216 | 172 | 97 | 5.678 | 115 | 108 |
| 4.7 | ±0.05 | 2.2 | 432 | 238 | 4.849 | 487 | 74 | 5.347 | 170 | 96 | 5.830 | 113 | 107 |
| 5.1 | ±0.05 | 2.1 | 408 | 225 | 5.288 | 464 | 71 | 5.868 | 159 | 93 | 6.437 | 106 | 105 |
| 5.6 | ±0.05 | 2.0 | 379 | 208 | 5.835 | 435 | 67 | 6.519 | 145 | 90 | 7.195 | 96 | 102 |
| 6.2 | ±0.1 | 1.9 | 355 | 195 | 6.440 | 408 | 65 | 7.176 | 137 | 86 | 7.897 | 91 | 96 |
| 6.8 | ±0.1 | 1.8 | 330 | 182 | 7.044 | 380 | 62 | 7.832 | 129 | 83 | 8.599 | 85 | 91 |
| 7.5 | ±0.1 | 1.7 | 308 | 169 | 7.823 | 351 | 61 | 8.927 | 115 | 81 | 10.08 | 74 | 89 |
| 8.2 | ±0.1 | 1.7 | 285 | 157 | 8.601 | 322 | 60 | 10.02 | 100 | 78 | 11.55 | 63 | 87 |
| 9.1 | ±0.1 | 1.6 | 266 | 146 | 9.600 | 304 | 58 | 11.55 | 93 | 77 | 13.93 | 57 | 85 |
| 10 | ±1% | 1.5 | 247 | 136 | 10.60 | 285 | 57 | 13.09 | 85 | 76 | 16.30 | 50 | 84 |
| 11 | ±1% | 1.5 | 225 | 124 | 11.71 | 265 | 56 | 14.79 | 76 | 74 | 18.94 | 43 | 82 |
| 12 | ±1% | 1.4 | 204 | 112 | 12.82 | 244 | 54 | 16.49 | 68 | 73 | 21.57 | 36 | 81 |
| 13 | ±1% | 1.3 | 193 | 106 | 13.97 | 230 | 53 | 18.64 | 61 | 72 | 26.09 | 32 | 80 |
| 14 | ±1% | 1.3 | 181 | 99 | 15.13 | 215 | 53 | 20.80 | 55 | 71 | 30.61 | 28 | 79 |
| 15 | ±1% | 1.2 | 169 | 93 | 16.28 | 200 | 52 | 22.95 | 48 | 70 | 35.13 | 24 | 78 |
| 16 | ±1% | 1.2 | 164 | 90 | 17.51 | 195 | 51 | 26.01 | 46 | 69 | 46.51 | 22 | 76 |
| 17 | ±1% | 1.2 | 159 | 88 | 18.75 | 189 | 50 | 29.07 | 43 | 67 | 57.90 | 19 | 75 |
| 18 | ±1% | 1.1 | 154 | 85 | 19.98 | 183 | 49 | 32.14 | 41 | 66 | 69.29 | 17 | 73 |
| 19 | ±1% | 1.1 | 150 | 82 | 21.21 | 178 | 49 | 36.34 | 39 | 66 | n/a | n/a | n/a |
| 20 | ±1% | 1.1 | 145 | 80 | 22.43 | 172 | 49 | 40.55 | 38 | 65 | n/a | n/a | n/a |
| 22 | ±1% | 1.0 | 136 | 75 | 24.88 | 162 | 49 | 48.96 | 34 | 64 | n/a | n/a | n/a |
| 24 | ±1% | 1.0 | 126 | 70 | 27.34 | 151 | 48 | 57.38 | 31 | 63 | n/a | n/a | n/a |
| 27 | ±1% | 0.9 | 112 | 62 | 31.02 | 135 | 48 | 70.00 | 26 | 62 | n/a | n/a | n/a |
| 30 | ±1% | 0.9 | 101 | 56 | 36.14 | 121 | 48 | n/a | n/a | n/a | n/a | n/a | n/a |
| 33 | ±1% | 0.8 | 90 | 50 | 41.27 | 108 | 48 | n/a | n/a | n/a | n/a | n/a | n/a |
| 36 | ±1% | 0.8 | 79 | 44 | 46.39 | 95 | 48 | n/a | n/a | n/a | n/a | n/a | n/a |
| 39 | ±1% | 0.8 | 68 | 38 | 51.52 | 82 | 48 | n/a | n/a | n/a | n/a | n/a | n/a |
| 43 | ±1% | 0.7 | 54 | 30 | 58.35 | 64 | 48 | n/a | n/a | n/a | n/a | n/a | n/a |
| 47 | ±1% | 0.7 | 39 | 21 | 65.18 | 46 | 48 | n/a | n/a | n/a | n/a | n/a | n/a |
| 82 | ±1% | 0.7 | 17 | 10 | 148.400 | 24 | 48 | n/a | n/a | n/a | n/a | n/a | n/a |

High Frequency Characteristics

1

Accu-P[®] 01005 Typical SRF vs Capacitance

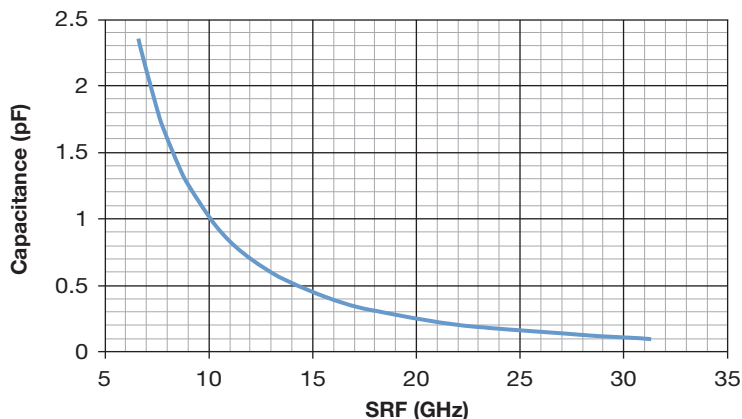

Measured on HP8720ES

Accu-P[®] 01005 Typical ESR vs Frequency

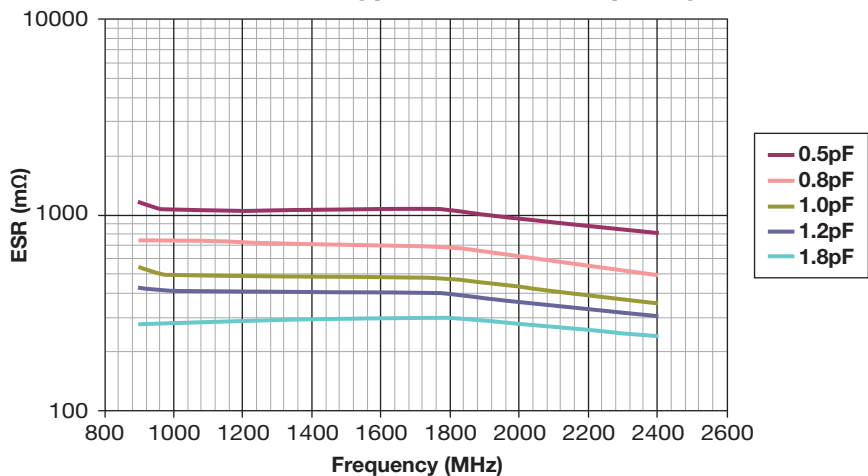

Measured on Agilent 4278A/4991A

Accu-P[®] 01005 Typical Q vs Frequency

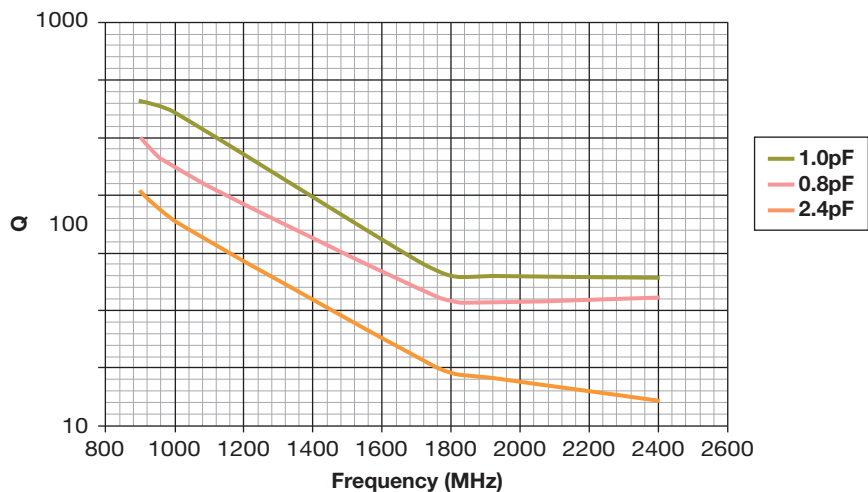

Measured on Agilent 4278A/4991A

Accu-P[®] 0201 Typical SRF vs Capacitance

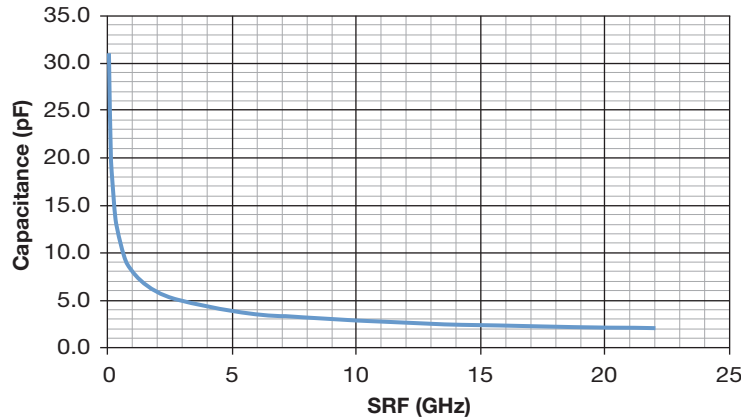

Measured on HP8720ES

Accu-P[®] 0201 Typical ESR vs Frequency

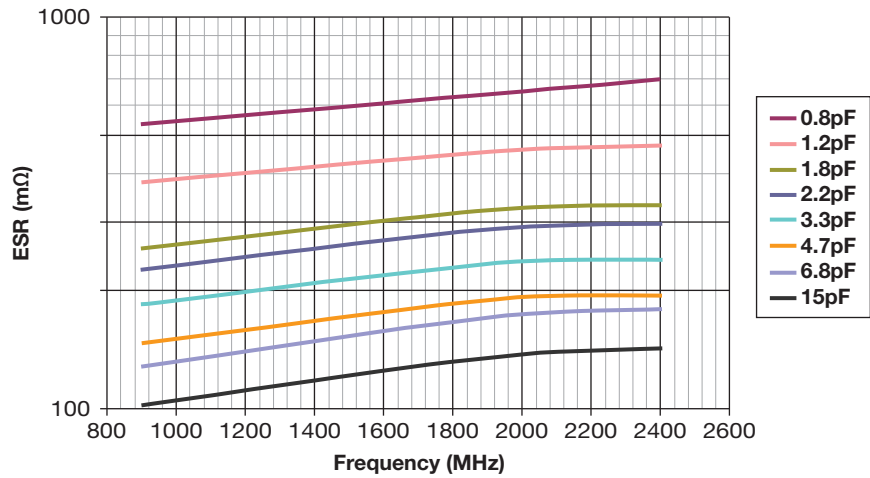

Measured on Agilent 4278A/4991A

Accu-P[®] 0201 Typical Q vs Frequency

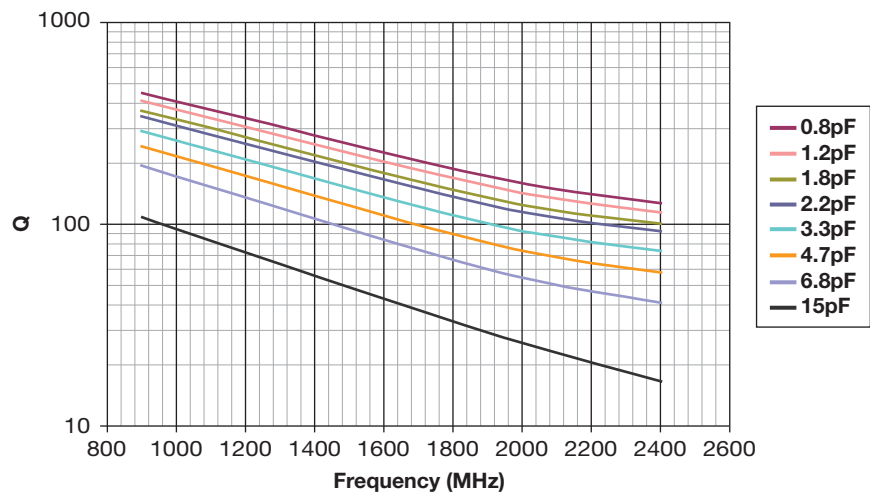

Measured on Agilent 4278A/4991A

High Frequency Characteristics

1

Accu-P[®] 0402 Typical SRF vs Capacitance

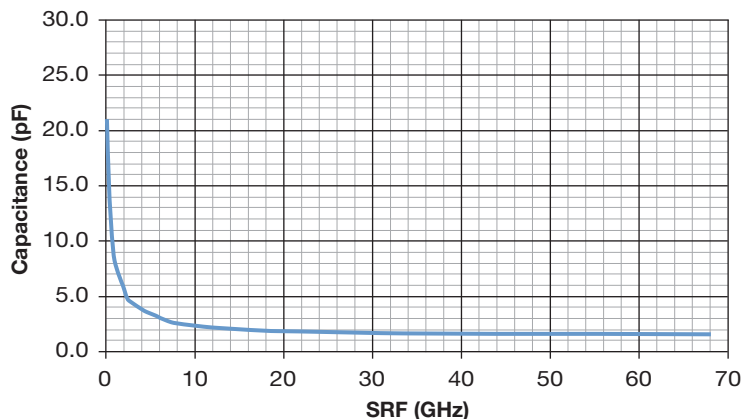

Measured on HP8720ES

Accu-P[®] 0402 Typical ESR vs Frequency

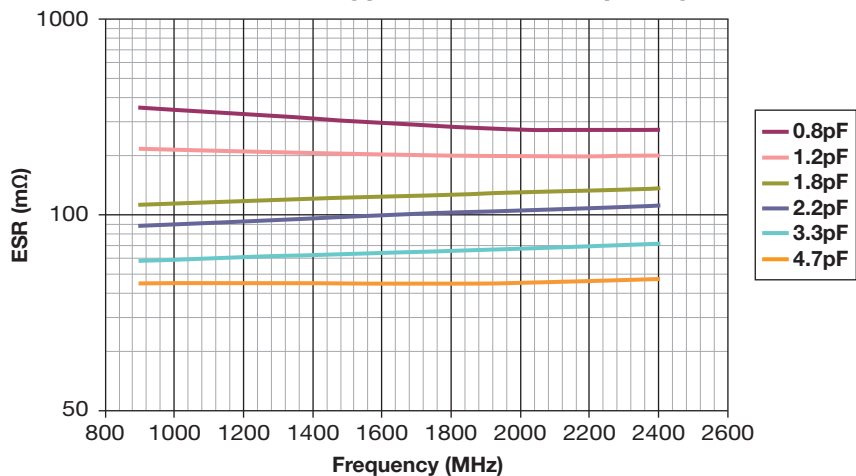

Measured on Agilent 4278A/4991A

Accu-P[®] 0402 Typical Q vs Frequency

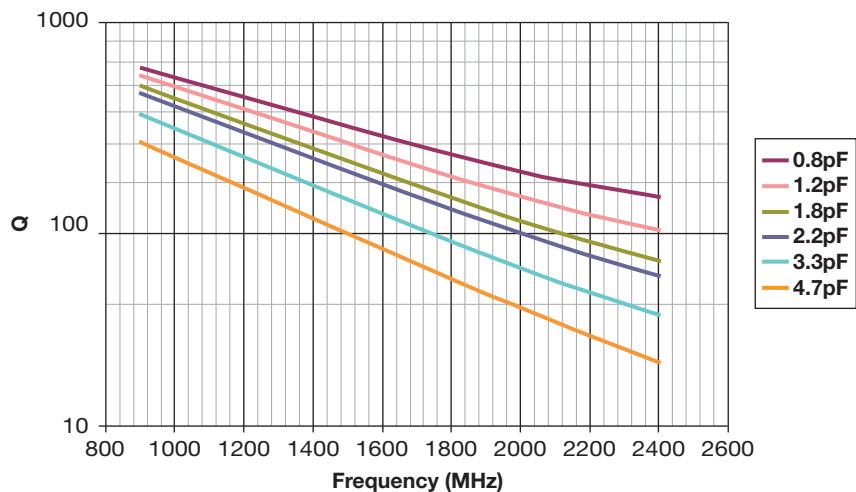

Measured on Agilent 4278A/4991A

High Frequency Characteristics

1

Accu-P® 0603 Typical SRF vs Capacitance

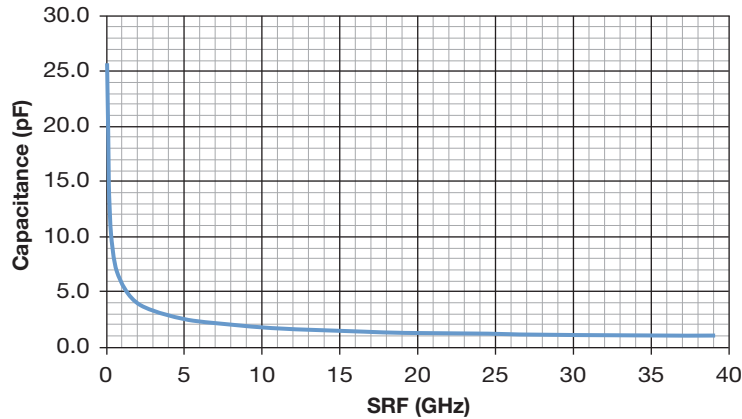

Measured on HP8720ES

Accu-P® 0603 Typical ESR vs Frequency

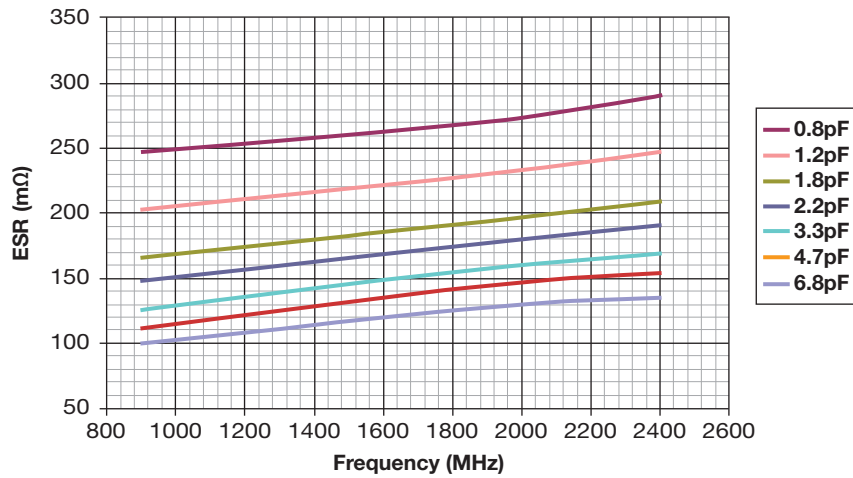

Measured on Agilent 4278A/4991A

Accu-P® 0603 Typical Q vs Frequency

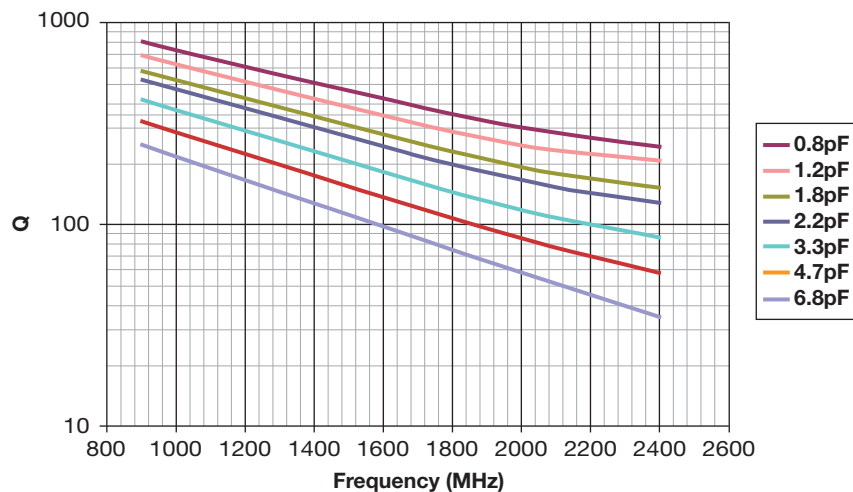

Measured on Agilent 4278A/4991A

High Frequency Characteristics

1

Accu-P[®] 0805 Typical SRF vs Capacitance

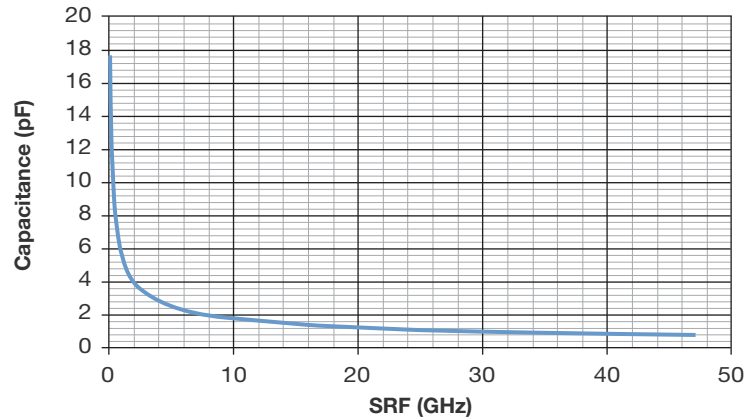

Measured on HP8720ES

Accu-P[®] 0805 Typical ESR vs Frequency

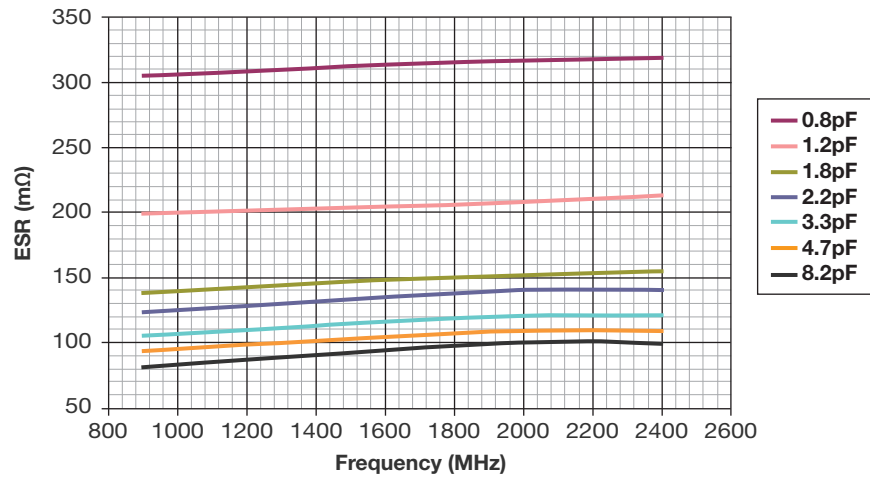

Measured on Agilent 4278A/4991A

Accu-P[®] 0805 Typical Q vs Frequency

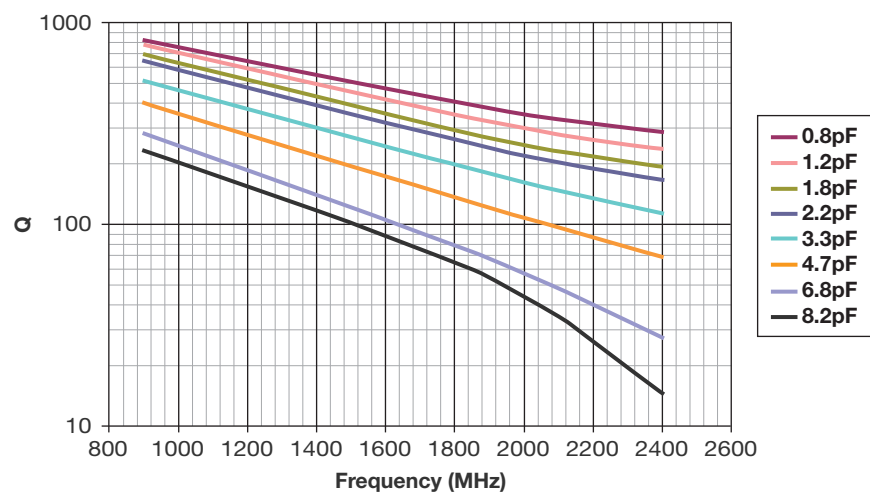

Measured on Agilent 4278A/4991A

Accu-P® 1210 Typical SRF vs Capacitance

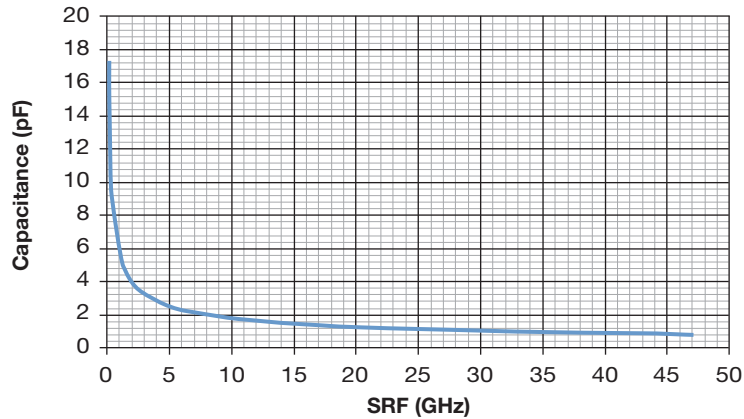

Measured on HP8720ES

Accu-P® 1210 Typical ESR vs Frequency

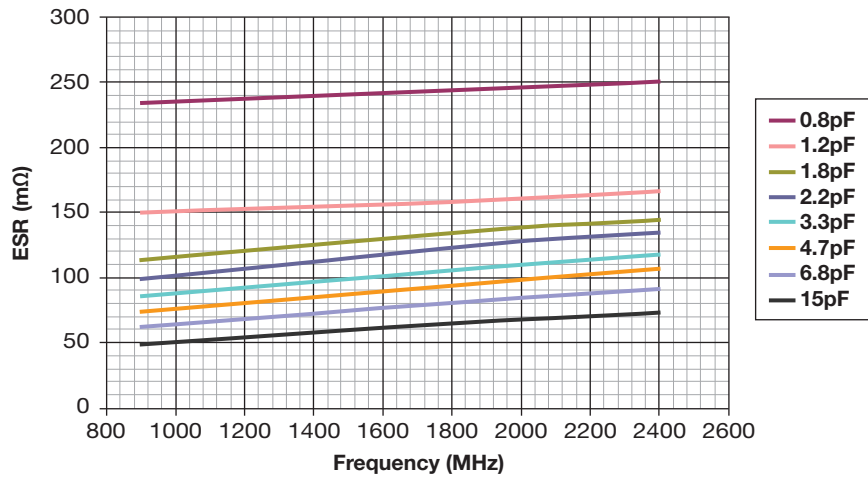

Measured on Agilent 4278A/4991A

Accu-P® 1210 Typical Q vs Frequency

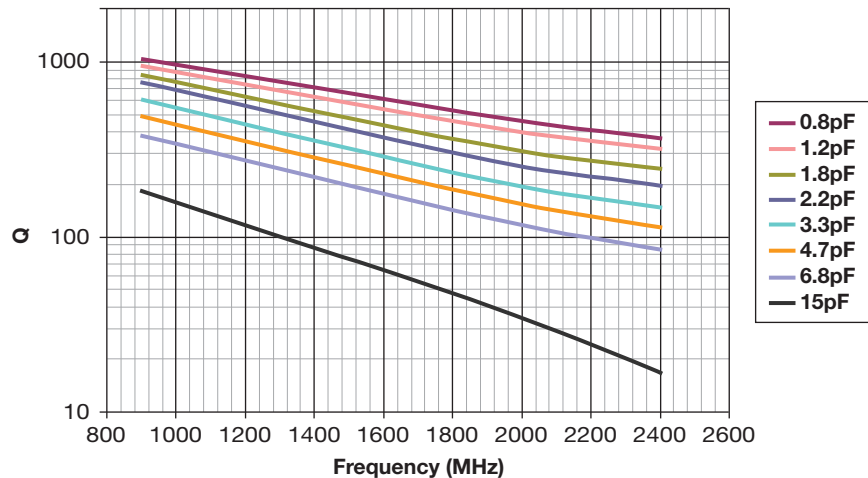

Measured on Agilent 4278A/4991A

Environmental / Mechanical Characteristics

ENVIRONMENTAL CHARACTERISTICS

| TEST | CONDITIONS | REQUIREMENT |
|--|---|--|
| Life (Endurance) MIL-STD-202F Method 108A | 125°C, 2U _R , 1000 hours | No visible damage $\Delta C/C \leq 2\%$ for $C \geq 5\text{pF}$ $\Delta C \leq 0.25\text{pF}$ for $C < 5\text{pF}$ |
| Accelerated Damp Heat Steady State MIL-STD-202F Method 103B | 85°C, 85% RH, U _R , 1000 hours | No visible damage $\Delta C/C \leq 2\%$ for $C \geq 5\text{pF}$ $\Delta C \leq 0.25\text{pF}$ for $C < 5\text{pF}$ |
| Temperature Cycling MIL-STD-202F Method 107E MIL-STD-883D Method 1010.7 | -55°C to +125°C, 15 cycles – Accu-P® | No visible damage $\Delta C/C \leq 2\%$ for $C \geq 5\text{pF}$ $\Delta C \leq 0.25\text{pF}$ for $C < 5\text{pF}$ |
| Resistance to Solder Heat IEC-68-2-58 | 260°C ± 5°C for 10 secs | C remains within initial limits |

MECHANICAL CHARACTERISTICS

| TEST | CONDITIONS | REQUIREMENT |
|--|---|--|
| Solderability IEC-68-2-58 | Components completely immersed in a solder bath at 235°C for 2 secs. | Terminations to be well tinned, minimum 95% coverage |
| Leach Resistance IEC-68-2-58 | Components completely immersed in a solder bath at 260±5°C for 60 secs. | Dissolution of termination faces ≤15% of area Dissolution of termination edges ≤25% of length |
| Adhesion MIL-STD-202F Method 211A | A force of 5N applied for 10 secs. | No visible damage |
| Termination Bond Strength IEC-68-2-21 Amend. 2 | Tested as shown in diagram D = 3mm Accu-P D = 1mm Accu-F | No visible damage $\Delta C/C \leq 2\%$ for $C \geq 5\text{pF}$ $\Delta C \leq 0.25\text{pF}$ for $C < 5\text{pF}$ |
| Robustness of Termination IEC-68-2-21 Amend. 2 | A force of 5N applied for 10 secs. | No visible damage |
| High Frequency Vibration MIL-STD-202F Method 201A, 204D (Accu-P® only) | 55Hz to 2000Hz, 20G | No visible damage |
| Storage | 12 months minimum with components stored in “as received” packaging | Good solderability |

QUALITY & RELIABILITY

Accu-P® is based on well established thin-film technology and materials.

• ON-LINE PROCESS CONTROL

This program forms an integral part of the production cycle and acts as a feedback system to regulate and control production processes. The test procedures, which are integrated into the production process, were developed after long research work and are based on the highly developed semiconductor industry test procedures and equipment. These measures help AVX to produce a consistent and high yield line of products.

• FINAL QUALITY INSPECTION

Finished parts are tested for standard electrical parameters and visual/mechanical characteristics. Each production lot is 100% evaluated for: capacitance and proof voltage at 2.5 U_R. In addition, production is periodically evaluated for:

Average capacitance with histogram printout for capacitance distribution;
IR and Breakdown Voltage distribution;
Temperature Coefficient;
Solderability;
Dimensional, mechanical and temperature stability.

QUALITY ASSURANCE

The reliability of these thin-film chip capacitors has been studied intensively for several years. Various measures have been taken to obtain the high reliability required today by the industry. Quality assurance policy is based on well established international industry standards. The reliability of the capacitors is determined by accelerated testing under the following conditions:

| | |
|------------------------------------|--|
| Life (Endurance) | 125°C, 2U _R , 1000 hours |
| Accelerated Damp Heat Steady State | 85°C, 85% RH, U _R , 1000 hours. |

Performance Characteristics RF Power Applications

RF POWER APPLICATIONS

In RF power applications capacitor losses generate heat. Two factors of particular importance to designers are:

- Minimizing the generation of heat.
- Dissipating heat as efficiently as possible.

CAPACITOR HEATING

- The major source of heat generation in a capacitor in RF power applications is a function of RF current (I) and ESR, from the relationship:

$$\text{Power dissipation} = I_{\text{RMS}}^2 \times \text{ESR}$$

- Accu-P® capacitors are specially designed to minimize

ESR and therefore RF heating. Values of ESR for Accu-P® capacitors are significantly less than those of ceramic MLC components currently available.

HEAT DISSIPATION

- Heat is dissipated from a capacitor through a variety of paths, but the key factor in the removal of heat is the thermal conductivity of the capacitor material.
- The higher the thermal conductivity of the capacitor, the more rapidly heat will be dissipated.
- The table below illustrates the importance of thermal conductivity to the performance of Accu-P® in power applications.

| PRODUCT | MATERIAL | THERMAL CONDUCTIVITY W/mK |
|---------------|--------------------|---------------------------|
| Accu-P® | Alumina | 18.9 |
| Microwave MLC | Magnesium Titanate | 6.0 |

**Power Handling
Accu-P® 10pF**

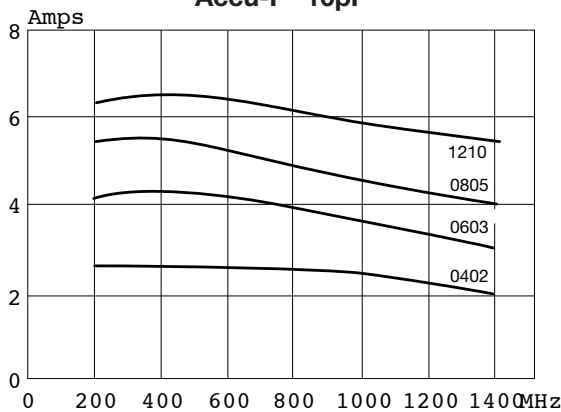

Data used in calculating the graph:

Thermal impedance of capacitors:

| | |
|------|---------|
| 0402 | 17°C/W |
| 0603 | 12°C/W |
| 0805 | 6.5°C/W |
| 1210 | 5°C/W |

Thermal impedance measured using RF generator, amplifier and strip-line transformer.

ESR of capacitors measured on Boonton 34A

THERMAL IMPEDANCE

Thermal impedance of Accu-P® chips is shown below compared with the thermal impedance of Microwave MLC's.

| CAPACITOR TYPE | CHIP SIZE | THERMAL IMPEDANCE (°C/W) |
|----------------|-----------|--------------------------|
| Accu-P® | 0805 | 6.5 |
| | 1210 | 5 |
| Microwave MLC | 0505 | 12 |
| | 1210 | 7.5 |

The thermal impedance expresses the temperature difference in °C between chip center and termination caused by a power dissipation of 1 watt in the chip. It is expressed in °C/W.

ADVANTAGES OF ACCU-P® IN RF POWER CIRCUITS

The optimized design of Accu-P® offers the designer of RF power circuits the following advantages:

- Reduced power losses due to the inherently low ESR of Accu-P®.
- Increased power dissipation due to the high thermal conductivity of Accu-P®.

• THE ONLY TRUE TEST OF A CAPACITOR IN ANY PARTICULAR APPLICATION IS ITS PERFORMANCE UNDER OPERATING CONDITIONS IN THE ACTUAL CIRCUIT.

PRACTICAL APPLICATION IN RF POWER CIRCUITS

- There is a wide variety of different experimental methods for measuring the power handling performance of a capacitor in RF power circuits. Each method has its own problems and few of them exactly reproduce the conditions present in "real" circuit applications.
- Similarly, there is a very wide range of different circuit applications, all with their unique characteristics and operating conditions which cannot possibly be covered by such "theoretical" testing.

1

GENERAL

Accu-P® SMD capacitors are designed for soldering to printed circuit boards or other substrates. The construction of the components is such that they will withstand the time/temperature profiles used in both wave and reflow soldering methods.

CIRCUIT BOARD TYPE

The circuit board types which may be used with Accu-P® are as follows:

- All flexible types of circuit boards (eg. FR-4, G-10) and also alumina.

For other circuit board materials, please consult factory.

HANDLING

SMD capacitors should be handled with care to avoid damage or contamination from perspiration and skin oils. The use of plastic tipped tweezers or vacuum pick-ups is strongly recommended for individual components. Bulk handling should ensure that abrasion and mechanical shock are minimized. For automatic equipment, taped and reeled product gives the ideal medium for direct presentation to the placement machine.

COMPONENT PAD DESIGN

Component pads must be designed to achieve good joints and minimize component movement during reflow soldering. Pad designs are given below for both wave and reflow soldering.

The basis of these designs is:

- Pad width equal to component width. It is permissible to decrease this to as low as 85% of component width but it is not advisable to go below this.
- Pad overlap 0.5mm beneath large components. Pad overlap about 0.3mm beneath small components.
- Pad extension of 0.5mm for reflow of large components and pad extension about 0.3mm for reflow of small components. Pad extension about 1.0mm for wave soldering.

REFLOW SOLDERING

PAD DIMENSIONS: millimeters (inches)

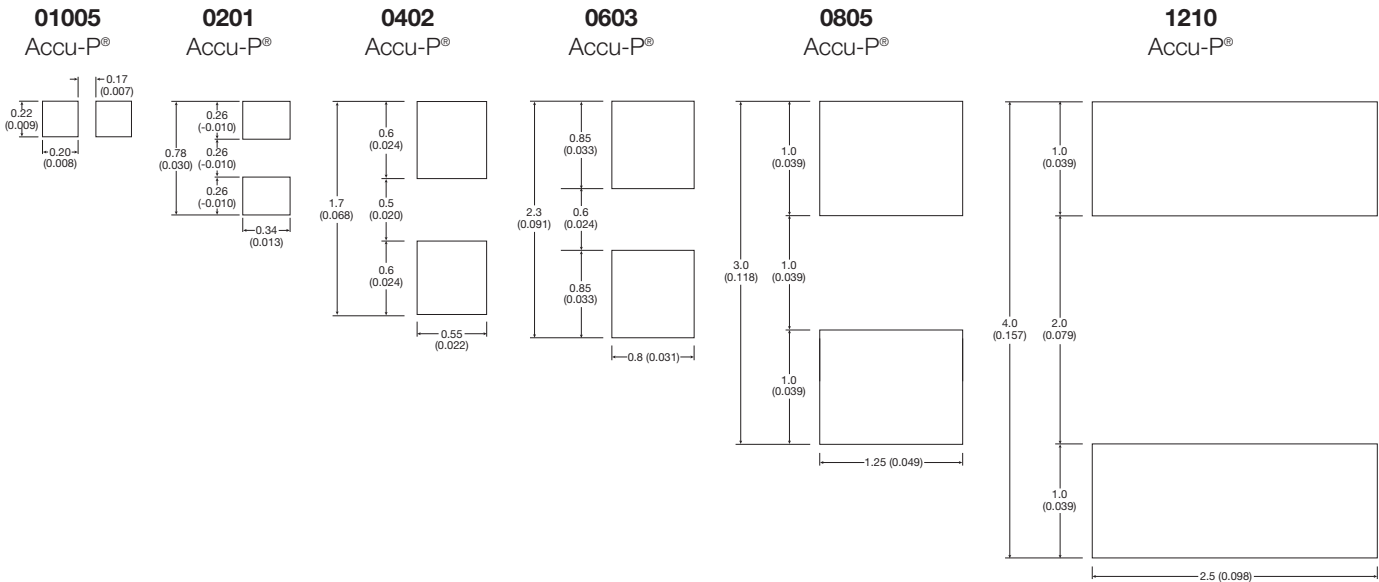

Application Notes

PREHEAT & SOLDERING

The rate of preheat in production should not exceed 4°C/second and a recommended maximum is about 2°C/second. Temperature differential from preheat to soldering should not exceed 100°C.

For further specific application or process advice, please consult AVX.

COOLING

After soldering, the assembly should preferably be allowed to cool naturally. In the event of assisted cooling, similar conditions to those recommended for preheating should be used.

HAND SOLDERING & REWORK

Hand soldering is permissible. Preheat of the PCB to 150°C is required. The most preferable technique is to use hot air soldering tools. Where a soldering iron is used, a temperature controlled model not exceeding 30 watts should be used and set to not more than 260°C.

CLEANING RECOMMENDATIONS

Care should be taken to ensure that the devices are thoroughly cleaned of flux residues, especially the space beneath the device. Such residues may otherwise become conductive and effectively offer a lossy bypass to the device. Various recommended cleaning conditions (which must be optimized for the flux system being used) are as follows:

- Cleaning liquids. i-propanol, ethanol, acetylacetone, water and other standard PCB cleaning liquids.
- Ultrasonic conditions . . power-20w/liter max.
frequency-20kHz to 45kHz.
- Temperature 80°C maximum (if not otherwise limited by chosen solvent system).
- Time 5 minutes max.

STORAGE CONDITIONS

Recommended storage conditions for Accu-P® prior to use are as follows:

- Temperature 15°C to 35°C
- Humidity ≤65%
- Air Pressure 860mbar to 1060mbar

RECOMMENDED REFLOW SOLDERING PROFILE COMPONENTS WITH SnPb TERMINATIONS

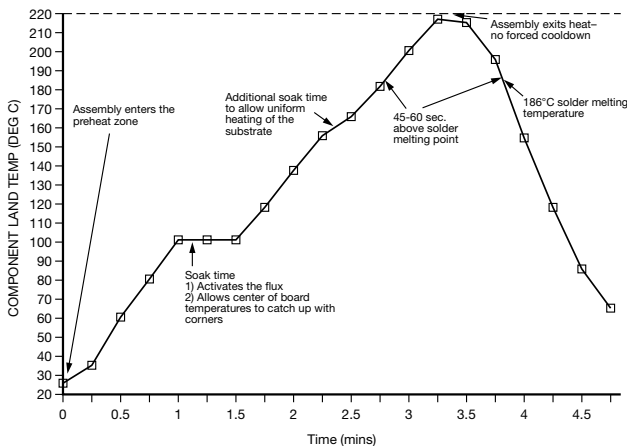

RECOMMENDED REFLOW SOLDERING PROFILE LEAD FREE COMPONENTS WITH Sn100 TERMINATIONS

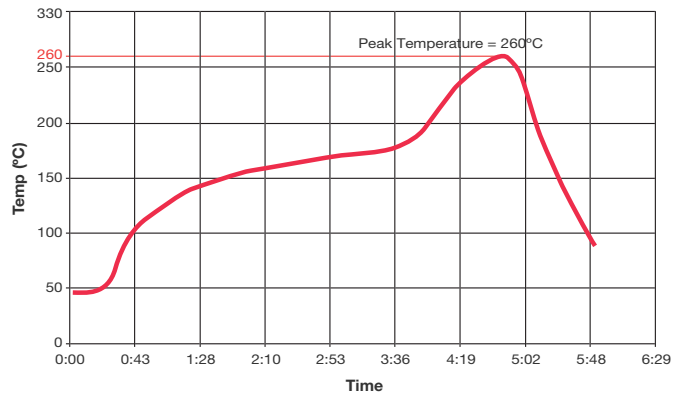

Automatic Insertion Packaging

TAPE & REEL

All tape and reel specifications are in compliance with EIA 481-1-A.
(equivalent to IEC 286 part 3).

- 8mm carrier
- Reeled quantities: Reels of 3,000 per 7" reel or 10,000 pieces per 13" reel
01005, 0201 and 0402 = 5,000 pieces per 7" reel and 20,000 pieces per 13" reel

REEL

DIMENSIONS: millimeters (inches)

| A ⁽¹⁾ | B | C | D | E | F | G |
|--------------------------|--------------------------|---------------------------|---------------------------|-------------------------|----------------------------|---------------------------|
| 180±1.0 (7.087±0.039) | 1.5 min. (0.059 min.) | 13±0.2 (0.512 ± 0.008) | 20.2 min. (0.795 min.) | 50 min. (1.969 min.) | 9.6±1.5 (0.370 ± 0.050) | 14.4 max. (0.567 max.) |

Metric dimensions will govern.
Inch measurements rounded and for reference only.

(1) 330mm (13 inch) reels are available.

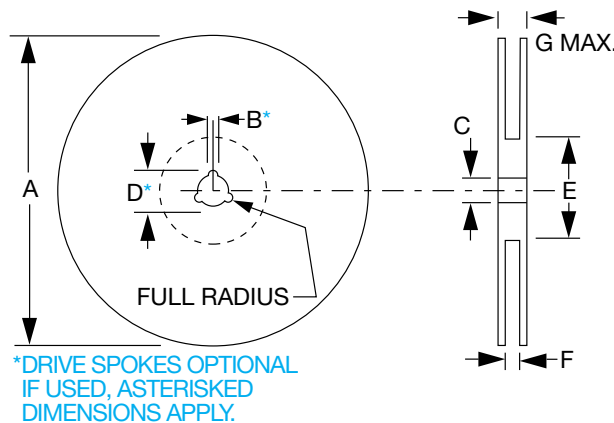

CARRIER

DIMENSIONS: millimeters (inches)

| A | B | C | D | E | F |
|------------------------------|-------------------------------|-----------------------------|-------------------------------|------------------------------|---|
| 8.0 ± 0.3 (0.315 ± 0.012) | 3.5 ± 0.05 (0.138 ± 0.002) | 1.75±0.1 (0.069 ± 0.004) | 2.0 ± 0.05 (0.079 ± 0.002) | 4.0 ± 0.1 (0.157 ± 0.004) | 1.5 ^{+0.1} _{-0.0} (0.059 ^{+0.004} _{-0.000}) |

The nominal dimensions of the component compartment (W,L) are derived from the component size.

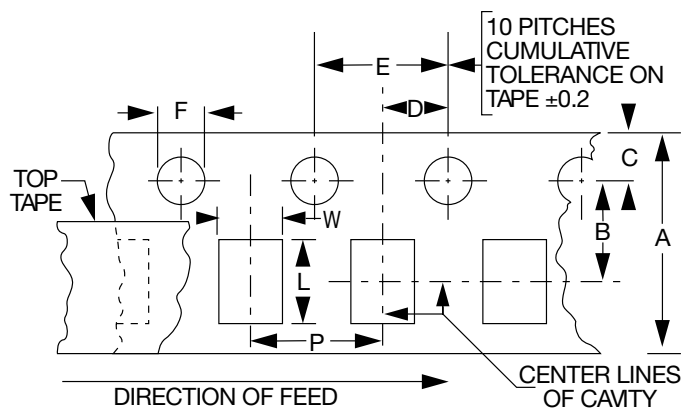

P = 4mm for 0603, 0805, 1210
P = 2mm for C005, 0201 and 0402

AVX reserves the right to change the information published herein without notice.

AVX RF

**Thin-Film RF/Microwave
Inductor Technology**

Accu-L[®]

Accu-L[®] 0201 Tight Tolerance



SMD RF Thin Film Tuning Inductor

2



ACCU-L[®] TECHNOLOGY

The L0201 SMD Tuning Inductor is based on thin-film multilayer technology. The technology provides a miniature part with excellent high frequency performance and rugged construction for reliable automatic assembly.

APPLICATIONS

- Mobile Communications
- Satellite TV Receivers
- GPS
- Vehicle Location Systems
- Wireless LAN's
- Filters
- Matching Networks

HOW TO ORDER



P/N Example: **L02013R3BHSTR**

QUALITY INSPECTION

Finished parts are 100% tested for electrical parameters and visual characteristics. Each production lot is evaluated on a sample basis for:

- Static Humidity: 85°C, 85% RH, 160 hours
- Endurance: 125°C, I_R, 4 hours

TERMINATION

Nickel/Lead Free solder coating compatible with automatic soldering technologies: reflow, wave soldering, vapor phase and manual.

DIMENSIONS: (TOP View)

millimeters (inches)

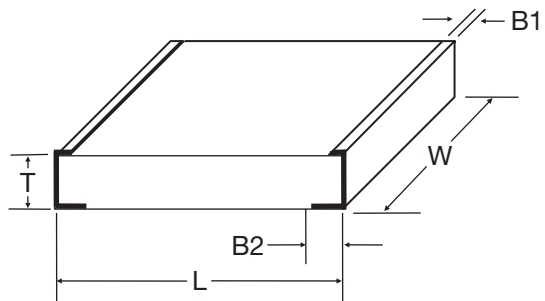

| | |
|---|------------------------------|
| L | 0.600±0.050 (0.024±0.002) |
| W | 0.325±0.050 (0.013±0.002) |
| T | 0.225±0.050 (0.009±0.002) |

| | |
|----|------------------------------|
| B1 | 0.100±0.100 (0.004±0.004) |
| B2 | 0.150±0.050 (0.006±0.002) |

Recommended Pad Layout Dimensions

mm (inches)

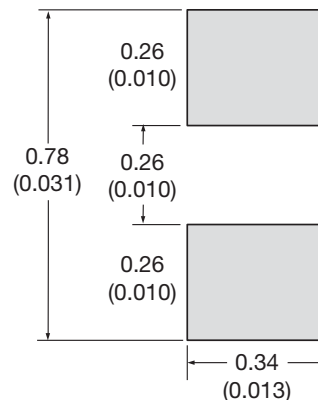

Accu-L[®] 0201 Tight Tolerance

SMD RF Thin Film Tuning Inductor



ELECTRICAL SPECIFICATIONS

| L(nH) | 450MHz | | 900MHz | 1900MHz | 2400MHz | SRF min. (GHz) | R _{dc} max. (Ω) | I _{dc} max. (mA) |
|-------|---|---------|---------|---------|---------|----------------|--------------------------|---------------------------|
| | Tolerance A=±0.05nH, B=±0.1nH, C=±0.2nH, D=±0.5nH | Q (min) | Q (Typ) | Q (Typ) | Q (Typ) | | | |
| 0.33 | ±0.05nH, ± 0.1nH, ± 0.2nH | 13 | 24 | 36 | 39 | 35 | 0.1 | 550 |
| 0.39 | ±0.05nH, ± 0.1nH, ± 0.2nH | 11 | 23 | 34 | 38 | 33 | 0.1 | 550 |
| 0.47 | ±0.05nH, ± 0.1nH, ± 0.2nH | 10 | 18 | 26 | 30 | 32 | 0.1 | 550 |
| 0.56 | ±0.05nH, ± 0.1nH, ± 0.2nH | 9 | 16 | 24 | 27 | 31 | 0.1 | 500 |
| 0.68 | ±0.05nH, ± 0.1nH, ± 0.2nH | 8 | 19 | 28 | 32 | 30 | 0.2 | 500 |
| 0.82 | ±0.05nH, ± 0.1nH, ± 0.2nH | 8 | 19 | 28 | 32 | 28 | 0.2 | 400 |
| 1.0 | ±0.05nH, ± 0.1nH, ± 0.2nH | 7 | 16 | 26 | 30 | 26 | 0.2 | 400 |
| 1.2 | ±0.05nH, ± 0.1nH, ± 0.2nH | 7 | 16 | 26 | 30 | 24 | 0.3 | 300 |
| 1.5 | ± 0.1nH, ± 0.2nH, ± 0.5nH | 7 | 16 | 26 | 30 | 23 | 0.5 | 250 |
| 1.8 | ± 0.1nH, ± 0.2nH, ± 0.5nH | 7 | 15 | 25 | 29 | 20 | 0.5 | 250 |
| 2.2 | ± 0.1nH, ± 0.2nH, ± 0.5nH | 7 | 15 | 22 | 24 | 18 | 0.6 | 200 |
| 2.7 | ± 0.1nH, ± 0.2nH, ± 0.5nH | 7 | 15 | 22 | 24 | 14 | 0.7 | 180 |
| 3.3 | ± 0.1nH, ± 0.2nH, ± 0.5nH | 7 | 15 | 22 | 24 | 13 | 1.0 | 150 |

All intermediate Inductance values within the indicated range are available.



L0402 Tight Tolerance



RF Inductor

GENERAL DESCRIPTION ITF TECHNOLOGY

The L0402 LGA Inductor is based on thin-film multilayer technology. The technology provides a miniature part with excellent high frequency performance and rugged construction for reliable automatic assembly.

APPLICATIONS

- Mobile Communications
- Satellite TV Receivers
- GPS
- Vehicle Location Systems
- Wireless LAN's
- Filters
- Matching Networks

LAND GRID ARRAY ADVANTAGES

- Inherent Low Profile
- Self Alignment during Reflow
- Excellent Solderability
- Low Parasitics
- Better Heat Dissipation

DIMENSIONS: (Bottom View)

millimeters (inches)

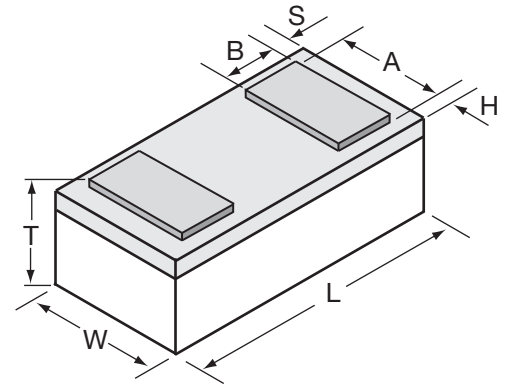

| | |
|---|----------------------------|
| L | 1.00±0.10 (0.039±0.004) |
| W | 0.58±0.07 (0.023±0.003) |
| T | 0.35±0.10 (0.014±0.004) |

| | |
|------|-----------------------------|
| A | 0.48±0.05 (0.019±0.002) |
| B | 0.17±0.05 (0.007±0.002) |
| S, H | 0.064±0.05 (0.003±0.002) |

HOW TO ORDER



P/N Example: **L04023R3BHNTTR**



QUALITY INSPECTION

Finished parts are 100% tested for electrical parameters and visual characteristics. Each production lot is evaluated on a sample basis for:

- Static Humidity: 85°C, 85% RH, 160 hours
- Endurance: 125°C, I_R, 4 hours

TERMINATION

Nickel/Lead Free solder coating compatible with automatic soldering technologies: reflow, wave soldering, vapor phase and manual.

MAKING AND ORIENTATION IN TAPE

(Top View)

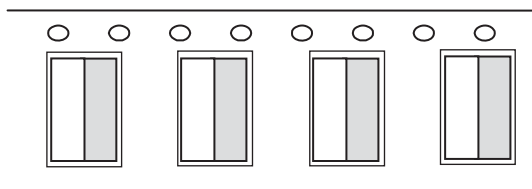

Recommended Pad Layout Dimensions mm (inches)

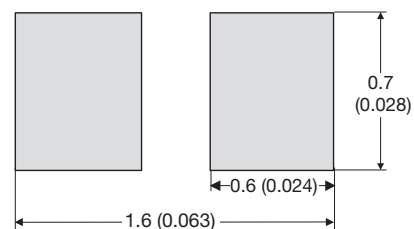

L0402 Tight Tolerance

RF Inductor



ELECTRICAL SPECIFICATIONS

| L(nH) | 450MHz | | | 900MHz | 1900MHz | 2400MHz | SRF min. (MHz) | R _{dc} max. (Ω) | I _{dc} max. (mA) |
|-------|---|---------|---------|---------|---------|---------|----------------|--------------------------|---------------------------|
| | Tolerance A=±0.05nH, B=±0.1nH, C=±0.2nH, D=±0.5nH | Q (min) | Q (Typ) | Q (Typ) | Q (Typ) | Q (Typ) | | | |
| 0.56 | ± 0.05nH, ± 0.1nH | 35 | 45 | 55 | 65 | 75 | 20000 | 0.02 | 1000 |
| 0.68 | ± 0.05nH, ± 0.1nH | 30 | 40 | 50 | 60 | 70 | 20000 | 0.04 | 750 |
| 0.82 | ± 0.05nH, ± 0.1nH | 25 | 40 | 50 | 60 | 70 | 20000 | 0.06 | 500 |
| 1.0 | ± 0.05nH, ± 0.1nH | 20 | 30 | 35 | 40 | 50 | 20000 | 0.15 | 500 |
| 1.2 | ± 0.05nH, ± 0.1nH, ± 0.2nH | 20 | 30 | 30 | 40 | 45 | 20000 | 0.20 | 400 |
| 1.5 | ± 0.05nH, ± 0.1nH, ± 0.2nH | 20 | 25 | 30 | 40 | 40 | 18000 | 0.20 | 400 |
| 1.8 | ± 0.05nH, ± 0.1nH, ± 0.2nH | 18 | 20 | 30 | 35 | 40 | 16000 | 0.20 | 400 |
| 2.2 | ± 0.05nH, ± 0.1nH, ± 0.2nH | 15 | 20 | 25 | 35 | 40 | 15000 | 0.20 | 400 |
| 2.7 | ± 0.05nH, ± 0.1nH, ± 0.2nH | 15 | 20 | 25 | 35 | 40 | 9500 | 0.25 | 250 |
| 3.3 | ± 0.1nH, ± 0.2nH, ± 0.5nH | 15 | 20 | 25 | 35 | 40 | 8500 | 0.40 | 250 |
| 3.9 | ± 0.1nH, ± 0.2nH, ± 0.5nH | 13 | 20 | 20 | 30 | 30 | 8000 | 0.45 | 250 |
| 4.7 | ± 0.1nH, ± 0.2nH, ± 0.5nH | 13 | 20 | 20 | 30 | 30 | 7500 | 0.45 | 250 |
| 5.6 | ± 0.1nH, ± 0.2nH, ± 0.5nH | 13 | 20 | 20 | 30 | 30 | 7000 | 0.65 | 200 |
| 6.8 | ± 0.1nH, ± 0.2nH, ± 0.5nH | 12 | 15 | 20 | 25 | 30 | 6500 | 0.90 | 200 |

Please contact factory for intermediate inductance values within the indicated range.



2

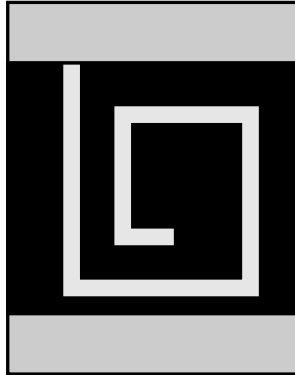

10 nH Inductor (Top View)

ACCU-L[®] TECHNOLOGY

The Accu-L[®] SMD Inductor is based on thin-film multilayer technology. This technology provides a level of control on the electrical and physical characteristics of the component which gives consistent characteristics within a lot and lot-to-lot.

The original design provides small size, excellent high-frequency performance and rugged construction for reliable automatic assembly.

The Accu-L[®] inductor is particularly suited for the telecommunications industry where there is a continuing trend towards miniaturization and increasing frequencies. The Accu-L[®] inductor meets both the performance and tolerance requirements of present cellular frequencies 450MHz and 900MHz and of future frequencies, such as 1700MHz, 1900MHz and 2400MHz.

FEATURES

- High Q
- RF Power Capability
- High SRF
- Low DC Resistance
- Ultra-Tight Tolerance on Inductance
- Standard 0603 and 0805 Chip Size
- Low Profile
- Rugged Construction
- Taped and Reeled

APPLICATIONS

- Mobile Communications
- Satellite TV Receivers
- GPS
- Vehicle Locations Systems
- Filters
- Matching Networks

DIMENSIONS: millimeters (inches)

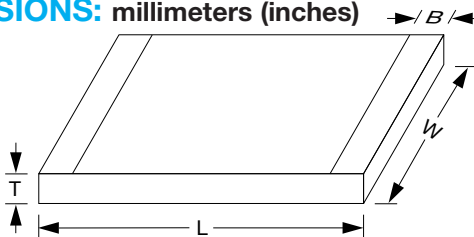

| | 0603 | 0805 |
|----------|---|----------------------------|
| L | 1.6±0.10 (0.063±0.004) | 2.11±0.10 (0.083±0.004) |
| W | 0.81±0.10 (0.032±0.004) | 1.5±0.10 (0.059±0.004) |
| T | 0.61±0.10 (0.024±0.004) | 0.91±0.13 (0.036±0.005) |
| B | top: 0.0 +0.3/-0.0 (0.0+0.012) bottom: 0.35±0.20 (0.014±0.008) | 0.25±0.15 (0.010±0.006) |

Operating/Storage
Temp. Range:
-55°C to +125°C

Accu-L[®] 0603 and 0805

SMD High-Q RF Inductor



HOW TO ORDER

| L | 0805 | 4R7 | D | E | S | TR |
|----------------------------|-----------------------------|---|---|---|---|---|
| Product Inductor | Size 0603 0805 | Inductance Expressed in nH (2 significant digits + number of zeros) for values <10nH, letter R denotes decimal point. Example: 22nH = 220 4.7nH = 4R7 | Tolerance for L ≤ 4.7nH, B = ±0.1nH C = ±0.2nH D = ±0.5nH 4.7nH < L < 10nH, C = ±0.2nH D = ±0.5nH L ≥ 10nH, G = ±2% J = ±5% | Specification Code E = Accu-L [®] 0805 technology G = Accu-L [®] 0603 technology | Termination Code W = Nickel/ solder coated (Sn 63, Pb 37) **S = Nickel/ Lead Free Solder coated (Sn100) | Packaging Code TR = Tape and Reel (3,000/reel) |

Not RoHS Compliant



For RoHS compliant products,
please select correct termination style.

****RoHS compliant**

**Engineering Kits Available
see pages 118-119**



ELECTRICAL SPECIFICATIONS TABLE FOR ACCU-L[®] 0603

| 450 MHz Test Frequency | | | 900 MHz Test Frequency | | 1900 MHz Test Frequency | | 2400 MHz Test Frequency | | SRF min (MHz) | R _{DC} max (Ω) | I _{DC} max (mA) |
|------------------------|--------------------------------|-----------|------------------------|-----------|-------------------------|-----------|-------------------------|-----------|---------------|-------------------------|--------------------------|
| Inductance L (nH) | Available Inductance Tolerance | Q Typical | L (nH) | Q Typical | L (nH) | Q Typical | L (nH) | Q Typical | | | |
| 1.2 | ±0.1, ±0.2nH | 49 | 1.2 | 70 | 1.2 | 134 | 1.2 | 170 | 10000 | 0.04 | 1000 |
| 1.5 | ±0.1, ±0.2nH | 26 | 1.54 | 39 | 1.52 | 63 | 1.52 | 76 | 10000 | 0.06 | 1000 |
| 1.8 | ±0.1, ±0.2nH | 20 | 1.74 | 30 | 1.73 | 50 | 1.72 | 59 | 10000 | 0.07 | 1000 |
| 2.2 | ±0.1, ±0.2nH | 20 | 2.2 | 30 | 2.24 | 49 | 2.24 | 56 | 10000 | 0.08 | 1000 |
| 2.7 | ±0.1, ±0.2nH | 21 | 2.7 | 30 | 2.75 | 48 | 2.79 | 54 | 9000 | 0.08 | 750 |
| 3.3 | ±0.1, ±0.2, ±0.5nH | 24 | 3.33 | 35 | 3.39 | 56 | 3.47 | 64 | 8400 | 0.08 | 750 |
| 3.9 | ±0.1, ±0.2, ±0.5nH | 25 | 3.9 | 57 | 4.06 | 60 | 4.21 | 69 | 6500 | 0.12 | 500 |
| 4.7 | ±0.1, ±0.2, ±0.5nH | 23 | 4.68 | 32 | 4.92 | 46 | 5.2 | 49 | 5500 | 0.15 | 500 |
| 5.6 | ±0.2, ±0.5nH | 26 | 5.65 | 36 | 5.94 | 54 | 6.23 | 60 | 5000 | 0.25 | 300 |
| 6.8 | ±0.2, ±0.5nH | 23 | 6.9 | 33 | 7.3 | 47 | 8.1 | 39 | 4500 | 0.30 | 300 |
| 8.2 | ±0.2, ±0.5nH | 23 | 8.4 | 31 | 10 | 35 | 12.1 | 31 | 3800 | 0.35 | 300 |
| 10.0 | ±2%, ±5% | 28 | 10 | 39 | 11.8 | 47 | 14.1 | 41 | 3500 | 0.45 | 300 |
| 12.0 | ±2%, ±5% | 28 | 13.2 | 38 | 14.1 | 30 | 17.2 | 20 | 3000 | 0.50 | 300 |
| 15.0 | ±2%, ±5% | 28 | 16.2 | 38 | 25.9 | 30 | 49.8 | 15 | 2500 | 0.60 | 300 |

(1) I_{DC} measured for 15°C rise at 25°C ambient temperature when soldered to FR-4 board.

Inductance and Q measured on Agilent 4291B / 4287 using the 16196A test fixture.

ELECTRICAL SPECIFICATIONS TABLE FOR ACCU-L[®] 0805

| 450 MHz Test Frequency | | | 900 MHz Test Frequency | | 1700 MHz Test Frequency | | 2400 MHz Test Frequency | | SRF min (MHz) | R _{DC} max (Ω) | I _{DC} max (mA) | |
|------------------------|--------------------------------|-----------|------------------------|-----------|-------------------------|-----------|-------------------------|-----------|---------------|-------------------------|--------------------------|---------------|
| Inductance L (nH) | Available Inductance Tolerance | Q Typical | L (nH) | Q Typical | L (nH) | Q Typical | L (nH) | Q Typical | | | ΔT = 15°C (1) | ΔT = 70°C (2) |
| 1.2 | ±0.1nH, ±0.2nH, ±0.5nH | 60 | 1.2 | 92 | 1.2 | 122 | 1.2 | 92 | 10000 | 0.05 | 1000 | 2000 |
| 1.5 | ±0.1nH, ±0.2nH, ±0.5nH | 50 | 1.5 | 74 | 1.5 | 102 | 1.5 | 84 | 10000 | 0.05 | 1000 | 2000 |
| 1.8 | ±0.1nH, ±0.2nH, ±0.5nH | 50 | 1.8 | 72 | 1.8 | 88 | 1.9 | 73 | 10000 | 0.06 | 1000 | 2000 |
| 2.2 | ±0.1nH, ±0.2nH, ±0.5nH | 42 | 2.2 | 62 | 2.2 | 82 | 2.3 | 72 | 10000 | 0.07 | 1000 | 2000 |
| 2.7 | ±0.1nH, ±0.2nH, ±0.5nH | 42 | 2.7 | 62 | 2.8 | 80 | 2.9 | 70 | 10000 | 0.08 | 1000 | 2000 |
| 3.3 | ±0.1nH, ±0.2nH, ±0.5nH | 38 | 3.3 | 46 | 3.4 | 48 | 3.5 | 57 | 10000 | 0.11 | 750 | 1500 |
| 3.9 | ±0.1nH, ±0.2nH, ±0.5nH | 27 | 3.9 | 36 | 4.0 | 38 | 4.1 | 42 | 10000 | 0.20 | 750 | 1500 |
| 4.7 | ±0.1nH, ±0.2nH, ±0.5nH | 43 | 4.8 | 62 | 5.3 | 76 | 5.8 | 60 | 5500 | 0.10 | 750 | 1500 |
| 5.6 | ±0.5nH | 50 | 5.7 | 68 | 6.3 | 73 | 7.6 | 62 | 4600 | 0.10 | 750 | 1500 |
| 6.8 | ±0.5nH | 43 | 7.0 | 62 | 7.7 | 71 | 9.4 | 50 | 4500 | 0.11 | 750 | 1500 |
| 8.2 | ±0.5nH | 43 | 8.5 | 56 | 10.0 | 55 | 15.2 | 32 | 3500 | 0.12 | 750 | 1500 |
| 10 | ±2%, ±5% | 46 | 10.6 | 60 | 13.4 | 52 | – | – | 2500 | 0.13 | 750 | 1500 |
| 12 | ±2%, ±5% | 40 | 12.9 | 50 | 17.3 | 40 | – | – | 2400 | 0.20 | 750 | 1500 |
| 15 | ±2%, ±5% | 36 | 16.7 | 46 | 27 | 23 | – | – | 2200 | 0.20 | 750 | 1000 |
| 18 | ±2%, ±5% | 30 | 21.9 | 27 | – | – | – | – | 1700 | 0.35 | 500 | 1000 |
| 22 | ±2%, ±5% | 36 | 27.5 | 33 | – | – | – | – | 1400 | 0.40 | 500 | 1000 |

(1) I_{DC} measured for 15°C rise at 25°C ambient temperature

(2) I_{DC} measured for 70°C rise at 25°C ambient temperature

L, Q, SRF measured on HP 4291A, Boonton 34A and Wiltron 360 Vector Analyzer, R_{DC} measured on Keithley 580 micro-ohmmeter.



Accu-L[®] 0603 and 0805



SMD High-Q RF Inductor

L0603

Typical Q vs. Frequency
L0603

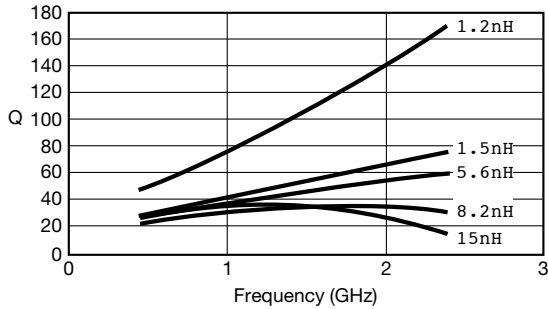

Measured on AGILENT 4291B/4287
using the 16196A test fixture

Typical Inductance vs. Frequency
L0603

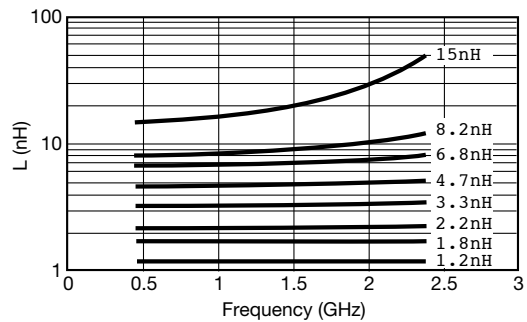

Measured on AGILENT 4291B/4287
using the 16196A test fixture

L0805

Typical Q vs. Frequency
L0805

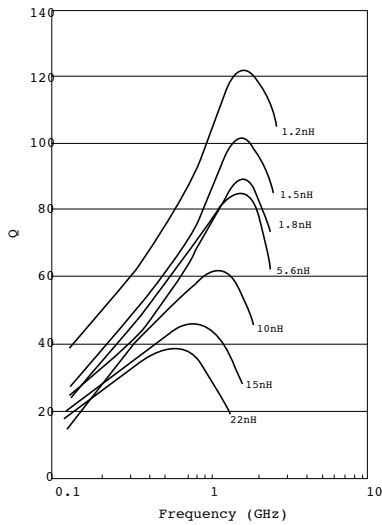

Measured on HP4291A and
Boonton 34A Coaxial Line

Typical Inductance vs. Frequency
L0805

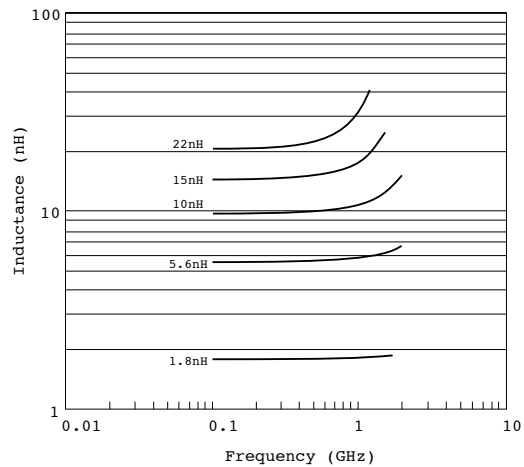

Measured on HP4291A and
Wiltron 360 Vector Analyzer

Maximum Temperature Rise
at 25°C ambient temperature (on FR-4)
L0805

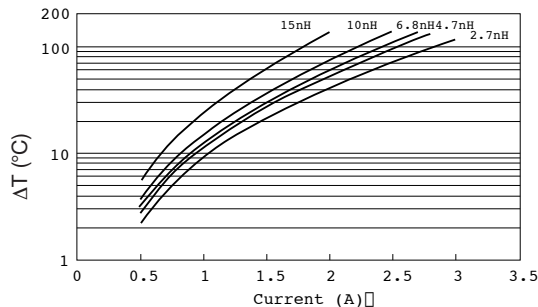

Temperature rise will typically be no higher than shown by the graph



2

Accu-L[®] 0603 and 0805



SMD High-Q RF Inductor

FINAL QUALITY INSPECTION

Finished parts are tested for electrical parameters and visual/mechanical characteristics.

Parts are 100% tested for inductance at 450MHz. Parts are 100% tested for R_{DC}. Each production lot is evaluated on a sample basis for:

- Q at test frequency
- Static Humidity Resistance: 85°C, 85% RH, 160 hours
- Endurance: 125°C, I_R, 4 hours

2

ENVIRONMENTAL CHARACTERISTICS

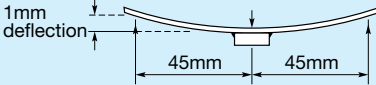
| TEST | CONDITIONS | REQUIREMENT |
|--|---|---|
| Solderability | Components completely immersed in a solder bath at 235 ± 5°C for 2 secs. | Terminations to be well tinned. No visible damage. |
| Leach Resistance | Components completely immersed in a solder bath at 260 ± 5°C for 60 secs. | Dissolution of termination faces ≤ 15% of area. Dissolution of termination edges ≤ 25% of length. |
| Storage | 12 months minimum with components stored in "as received" packaging. | Good solderability |
| Shear | Components mounted to a substrate. A force of 5N applied normal to the line joining the terminations and in a line parallel to the substrate. | No visible damage |
| Rapid Change of Temperature | Components mounted to a substrate. 5 cycles -55°C to +125°C. | No visible damage |
| Bend Strength | Tested as shown in diagram  | No visible damage |
| Temperature Coefficient of Inductance (TCL) | Component placed in environmental chamber -55°C to +125°C. | +0 to +125 ppm/°C (typical) $TCL = \frac{L_2 - L_1}{L_1 (T_2 - T_1)} \cdot 10^6$ T ₁ = 25°C |

Application Notes

HANDLING

SMD chips should be handled with care to avoid damage or contamination from perspiration and skin oils. The use of plastic tipped tweezers or vacuum pick-ups is strongly recommended for individual components. Bulk handling should ensure that abrasion and mechanical shock are minimized. For automatic equipment, taped and reeled product is the ideal medium for direct presentation to the placement machine.

CIRCUIT BOARD TYPE

All flexible types of circuit boards may be used (e.g. FR-4, G-10) and also alumina.

For other circuit board materials, please consult factory.

COMPONENT PAD DESIGN

Component pads must be designed to achieve good joints and minimize component movement during soldering.

Pad designs are given below for both wave and reflow soldering.

The basis of these designs is:

- Pad width equal to component width. It is permissible to decrease this to as low as 85% of component width but it is not advisable to go below this.
- Pad overlap about 0.3mm.
- Pad extension about 0.3mm for reflow.
Pad extension about 0.8mm for wave soldering.

REFLOW SOLDERING

DIMENSIONS: millimeters (inches)

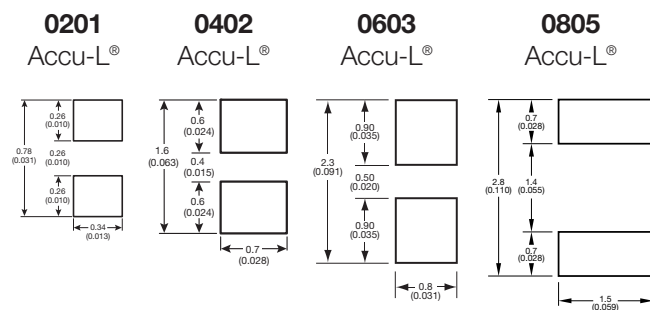

PREHEAT & SOLDERING

The rate of preheat in production should not exceed 4°C/second. It is recommended not to exceed 2°C/second.

Temperature differential from preheat to soldering should not exceed 150°C.

For further specific application or process advice, please consult AVX.

HAND SOLDERING & REWORK

Hand soldering is permissible. Preheat of the PCB to 100°C is required. The most preferable technique is to use hot air soldering tools. Where a soldering iron is used, a temperature controlled model not exceeding 30 watts should be used and set to not more than 260°C. Maximum allowed time at temperature is 1 minute. When hand soldering, the base side (white side) must be soldered to the board.

COOLING

After soldering, the assembly should preferably be allowed to cool naturally. In the event of assisted cooling, similar conditions to those recommended for preheating should be used.

CLEANING RECOMMENDATIONS

Care should be taken to ensure that the devices are thoroughly cleaned of flux residues, especially the space beneath the device. Such residues may otherwise become conductive and effectively offer a lossy bypass to the device. Various recommended cleaning conditions (which must be optimized for the flux system being used) are as follows:

- Cleaning liquids i-propanol, ethanol, acetone, water, and other standard PCB cleaning liquids.
- Ultrasonic conditions . . . power – 20w/liter max.
frequency – 20kHz to 45kHz.
- Temperature 80°C maximum (if not otherwise limited by chosen solvent system).
- Time. 5 minutes max.

STORAGE CONDITIONS

Recommended storage conditions for Accu-L® prior to use are as follows:

- Temperature. 15°C to 35°C
- Humidity ≤65%
- Air Pressure 860mbar to 1060mbar

RECOMMENDED SOLDERING PROFILE

For recommended soldering profile see page 29



Thin-Film RF/Microwave Directional Couplers

CP0302/CP0402/CP0603/CP0805
and DB0603N/DB0805 3dB 90°

Thin Film Directional Couplers

Wide Band High Directivity



CP0402W2700FNTR

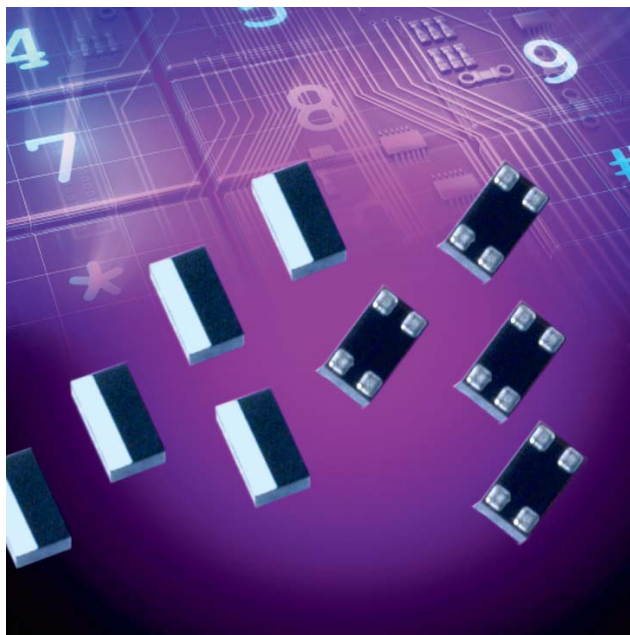

ITF TECHNOLOGY

The ITF High Directivity Wide Band LGA Coupler is based on thin-film multilayer technology. The technology provides a miniature part with excellent high frequency performance and rugged construction for reliable automatic assembly.

The Wide Band High Directivity Coupler displays a stable coupling factor over a wide frequency band.

APPLICATIONS

- Mobile communications
- Satellite TV receivers
- GPS
- Vehicle location systems
- Wireless LAN's

LAND GRID ARRAY ADVANTAGES

- Inherent Low Profile
- Self Alignment during Reflow
- Excellent Solderability
- Low Parasitics
- Better Heat Dissipation

DIMENSIONS (Bottom View)

mm (inches)

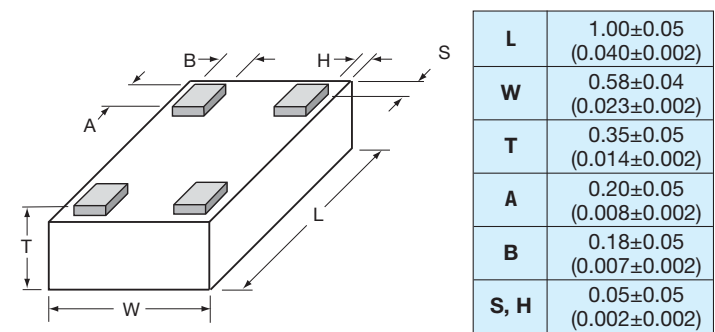

HOW TO ORDER

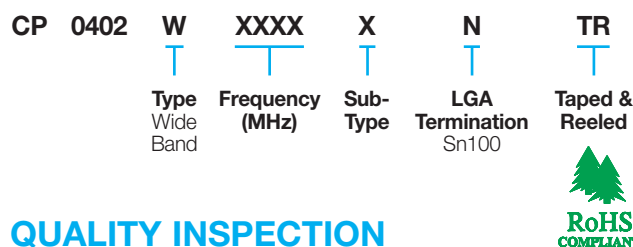

QUALITY INSPECTION

Finished parts are 100% tested for electrical parameters and visual characteristics. Each production lot is evaluated on a sample basis for:

- Static Humidity: 85°C, 85% RH, 160 hours
- Endurance: 125°C, I_R, 4 hours

TERMINATION

Nickel/Lead Free solder coating compatible with automatic soldering technologies: reflow, wave soldering, vapor phase and manual.

OPERATING TEMPERATURE

-40°C to +85°C

POWER RATING

3W RF Continuous

TERMINALS (Top View)

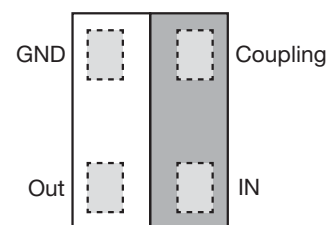

Recommended Pad Layout Dimensions mm (inches)

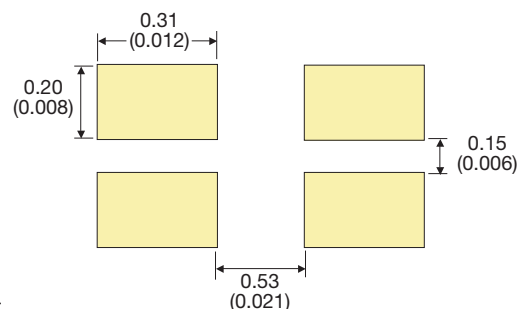

Thin Film Directional Couplers

Wide Band High Directivity



CP0402W2700FNTR

Directional Coupler Type CP0402W2700FNTR

| P/N | Frequency [MHz] | Coupling [dB] | I. Loss max. [dB] | Return Loss [dB] | Directivity [dB] |
|-----------------|-----------------|---------------|-------------------|------------------|------------------|
| CP0402W2700FNTR | 700-2,700 | 24±2 | 0.3 | 18 | 20 |

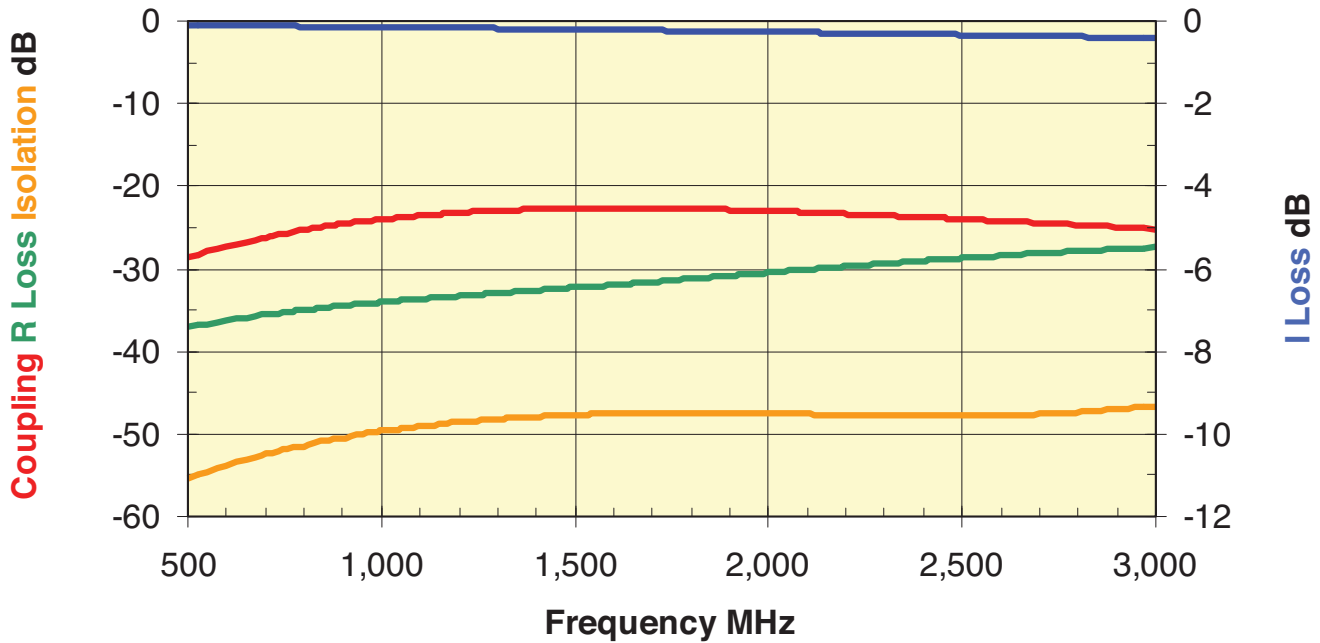

3

Thin Film Directional Couplers

Wide Band High Directivity



CP0402W2700FNTR Test Jigs

GENERAL DESCRIPTION

These jigs are designed for testing the CP0402W2700FNTR High Directivity Couplers using a Vector Network Analyzer.

They consist of a dielectric substrate, having 50Ω microstrips as conducting lines and a bottom ground plane located at a distance of 0.254mm (0.010") from the microstrips.

The substrate used is Neltec's NH9338ST0254C1BC.

The connectors are SMA type (female), 'Johnson Components Inc.' Product P/N: 142-0701-841.

Both a measurement jig and a calibration jig are provided.

The calibration jig is designed for a full 2-port calibration, and consists of an open line, short line and through line. LOAD calibration can be done by a 50Ω SMA termination.

MEASUREMENT PROCEDURE

When measuring a component, it can be either soldered or pressed using a non-metallic stick until all four ports touch the appropriate pads. Set the VNA to the relevant frequency band. Connect the VNA using a 10dB attenuator on the jig

terminal connected to port 2. Follow the VNA's instruction manual and use the [calibration jig](#) to perform a full 2-Port calibration in the required bandwidths.

3

Place the coupler on the measurement jig as follows:

- | | |
|--|-----------------------------------|
| GND (Coupler) → Connector 1 (Jig) | IN (Coupler) → Connector 3 (Jig) |
| Coupling (Coupler) → Connector 2 (Jig) | Out (Coupler) → Connector 4 (Jig) |

To measure I. Loss connect:

- | | |
|----------------------------------|-------------------------|
| Connector 3 (Jig) → Port 1 (VNA) | Connector 2 (Jig) → 50Ω |
| Connector 4 (Jig) → Port 2 (VNA) | |

To measure R. Loss and Coupling connect:

- | | |
|----------------------------------|-------------------------|
| Connector 3 (Jig) → Port 1 (VNA) | Connector 4 (Jig) → 50Ω |
| Connector 2 (Jig) → Port 2 (VNA) | |

To measure Isolation connect:

- | | |
|----------------------------------|----------------------------------|
| Connector 4 (Jig) → Port 1 (VNA) | Connector 2 (Jig) → Port 2 (VNA) |
| Connector 3 (Jig) → 50Ω | |

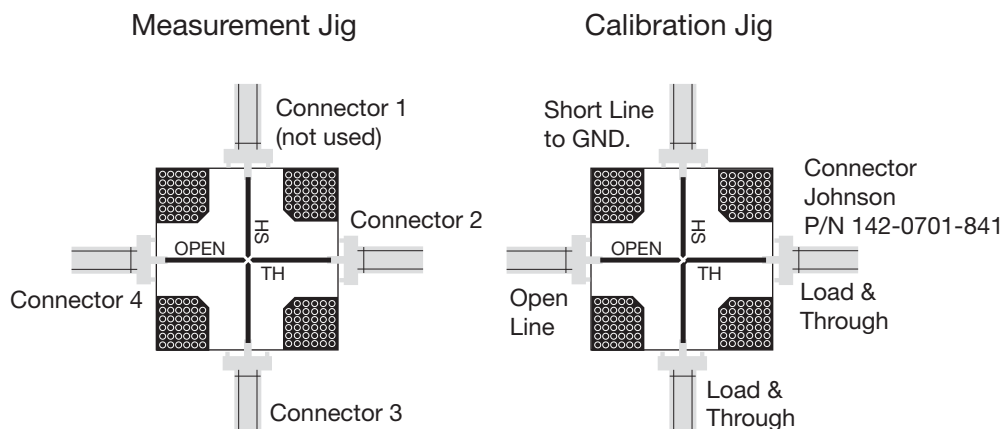

Thin Film Directional Couplers

WiFi Band High Directivity



CP0302P5425ENTR / CP0302A5425ENTR / CP0402Q5425ENTR / CP0603Q5425ENTR HIGH DIRECTIVITY DIRECTIONAL COUPLERS FOR WIFI BANDS

TECHNOLOGY

These High Directivity LGA Couplers are based on thin-film multilayer technology. The technology provides a miniature part with excellent high frequency performance and rugged construction for reliable automatic assembly. The WiFi Bands Couplers are offered in 0302, 0402 and 0603 standard sizes having identical electrical performance.



DIMENSIONS (Bottom View) mm (inches)

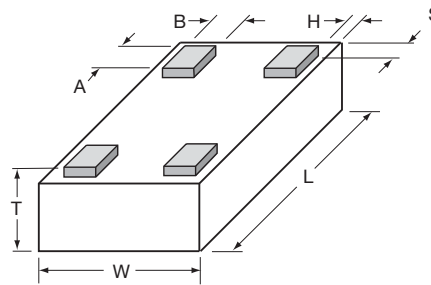

APPLICATIONS:

- WiFi

PART NUMBERS

CP0302P5425ENTR
CP0302A5425ENTR
CP0402Q5425ENTR
CP0603Q5425ENTR

QUALITY INSPECTION

Finished parts are 100% tested for electrical parameters and visual characteristics. Each production lot is evaluated on a sample basis for:

- Static Humidity: 85°C, 85% RH, 160 hours
- Endurance : 125°C, IR, 4 hours

TERMINATION

Nickel/Lead-Free Solder coating (Sn100) compatible with automatic soldering technologies: reflow, wave soldering, vapor phase and manual.

OPERATING TEMPERATURE

-40°C to +85°C

TERMINALS (Top View)

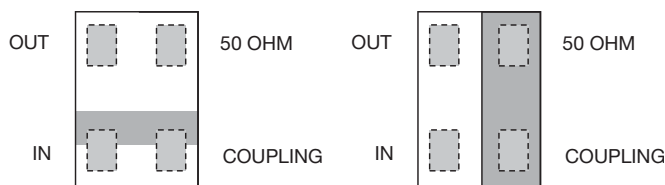

CP0302

CP0402

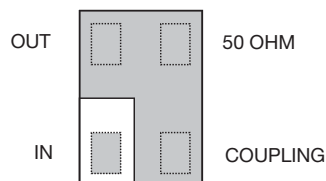

CP0603

| | CP0302 | CP0402 | CP0603 |
|-------------|------------------------------|----------------------------|----------------------------|
| L | 0.65±0.04 (0.026±0.002) | 1.0±0.05 (0.040±0.002) | 1.6±0.1 (0.063±0.004) |
| W | 0.50±0.04 (0.02±0.002) | 0.58±0.04 (0.023±0.002) | 0.84±0.1 (0.033±0.004) |
| T | 0.25±0.05 (0.01±0.002) | 0.35±0.05 (0.014±0.002) | 0.60±0.1 (0.024±0.004) |
| A | 0.20±0.05 (0.008±0.002) | 0.20±0.05 (0.008±0.002) | 0.25±0.05 (0.01±0.002) |
| B | 0.10±0.04 (0.004±0.002) | 0.18±0.05 (0.007±0.002) | 0.20±0.05 (0.008±0.002) |
| S, H | 0.025±0.025 (0.001±0.001) | 0.05±0.05 (0.002±0.002) | 0.05±0.05 (0.002±0.002) |



RECOMMENDED PAD LAYOUT DIMENSIONS

mm (inches)

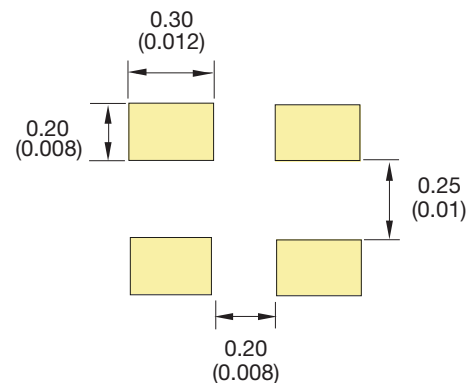

CP0302

CP0402 / CP0603: see pages 49 / 53

Thin Film Directional Couplers WiFi Band High Directivity



ELECTRICAL CHARACTERISTICS

| P/N | Frequency [MHz] | Coupling [dB] | I. Loss max. [dB] | Return Loss [dB] | Directivity [dB] |
|-----------------|-----------------|---------------|-------------------|------------------|------------------|
| CP0302P5425ENTR | 2,400-2,496 | -20±0.5 | -0.2 | -30 | 20 |
| | 4,900-5,950 | -13±0.5 | -0.4 | -25 | 20 |

| P/N | Frequency [MHz] | Coupling [dB] | I. Loss max. [dB] | Return Loss [dB] | Directivity [dB] |
|-----------------|-----------------|---------------|-------------------|------------------|------------------|
| CP0302A5425ENTR | 2,400-2,496 | -20±1 | -0.2 | -30 | 20 |
| | 4,900-5,950 | -13±1 | -0.4 | -25 | 20 |

| P/N | Frequency [MHz] | Coupling [dB] | I. Loss max. [dB] | Return Loss [dB] | Directivity [dB] |
|------------------------------------|-----------------|---------------|-------------------|------------------|------------------|
| CP0402Q5425ENTR CP0603Q5425ENTR | 2,400-2,496 | -20±1 | -0.3 | -30 | 20 |
| | 4,900-5,950 | -13±1 | -0.4 | -25 | 20 |

3

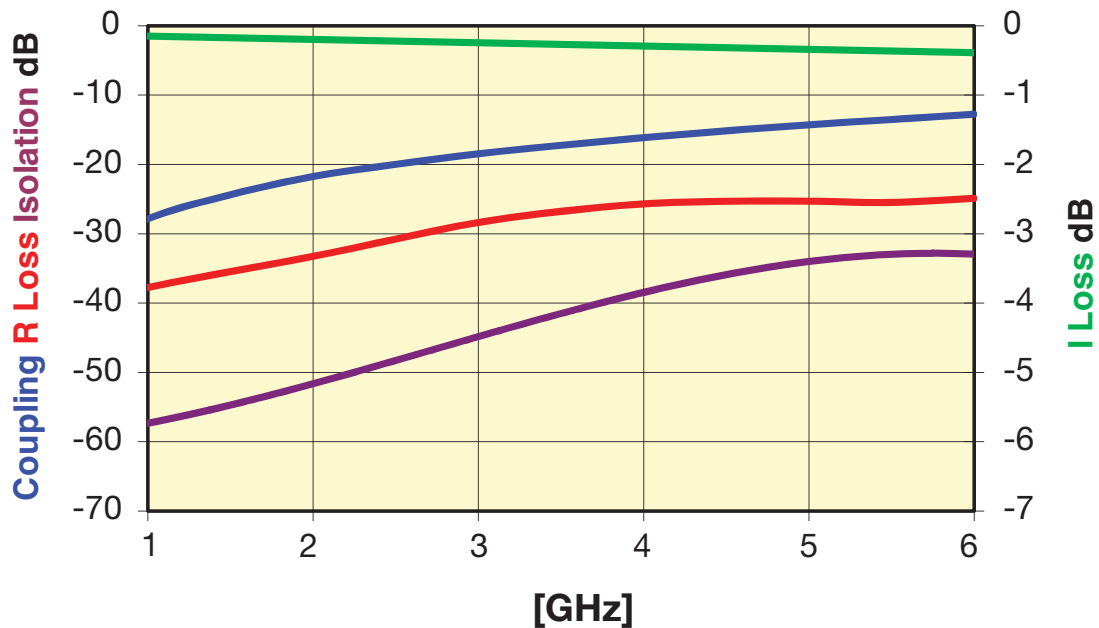

Thin Film Directional Coupler



CP0402P High Directivity, Tight Coupling Tolerance

GENERAL DESCRIPTION

ITF (Integrated Thin-Film) TECHNOLOGY

The CP0402P Series High Directivity, Tight Coupling Tolerance LGA Coupler is based on the proprietary RFAP Thin-Film multilayer technology. The technology provides a miniature part with excellent high frequency performance and rugged construction for reliable automatic assembly.

The ITF Coupler is offered in a variety of frequency bands compatible with various types of high frequency wireless systems.

APPLICATIONS

- Wireless communications
- Wireless LAN's
- GPS
- WiMAX

LAND GRID ARRAY ADVANTAGES

- Inherent Low Profile
- Self Alignment during Reflow
- Excellent Solderability
- Low Parasitics
- Better Heat Dissipation
- Power Rating 3W RF Continuous

DIMENSIONS: (Bottom View)

millimeters (inches)

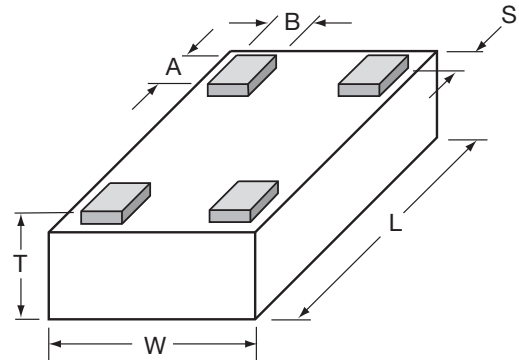

| | |
|---|----------------------------|
| L | 1.00±0.05 (0.040±0.002) |
| W | 0.58±0.04 (0.023±0.002) |
| T | 0.35±0.05 (0.014±0.002) |

| | |
|---|----------------------------|
| A | 0.20±0.05 (0.008±0.002) |
| B | 0.18±0.05 (0.007±0.002) |
| S | 0.05±0.05 (0.002±0.002) |

HOW TO ORDER

CP
T
Style

0402
T
Size
0402

P
T
Type
±0.5dB
Tight Tolerance

XXXX
T
Frequency
MHz

X
T
Sub-Type

N
T
Termination
LGA
Lead-Free

TR
T
Taped & Reeled

QUALITY INSPECTION

Finished parts are 100% tested for electrical parameters and visual characteristics. Each production lot is evaluated on a sample basis for:

- Static Humidity: 85°C, 85% RH, 160 hours
- Endurance: 125°C, I_b, 4 hours

TERMINATION

Nickel/Lead-Free Solder coating compatible with automatic soldering technologies: reflow, wave soldering, vapor phase and manual.

TERMINALS (Top View)

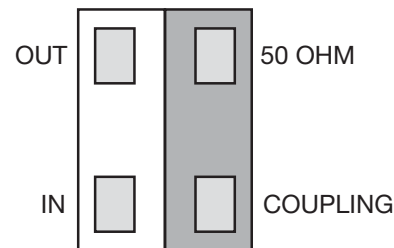

OPERATING TEMPERATURE:

-40°C to +85°C

Recommended Pad Layout Dimensions

mm (inches)

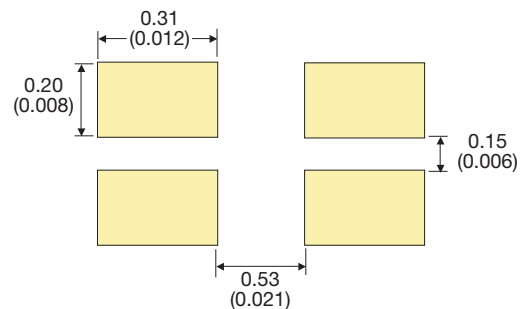

Thin Film Directional Coupler

CP0402P High Directivity, Tight Coupling Tolerance



Coupler P/N CP0402PxxxxAN

| Application | P/N Examples* | Frequency Band [MHz] | Coupling [dB] | I. Loss max. [dB] | Return Loss [dB] | Directivity [dB] | |
|--------------|---------------|----------------------|---------------|-------------------|------------------|------------------|----|
| AMPS | CP0402P0836AN | 824 - 849 | 19.10±0.5 | 0.25 | 32 | 21 | |
| | CP0402P0881AN | 869 - 894 | 18.60±0.5 | 0.25 | 31 | | |
| GSM | CP0402P0902AN | 890 - 915 | 18.50±0.5 | 0.25 | 31 | | |
| | CP0402P0947AN | 935 - 960 | 18.00±0.5 | 0.25 | 31 | | |
| E-GSM | CP0402P0897AN | 880 - 915 | 18.50±0.5 | 0.25 | 31 | | |
| | CP0402P0942AN | 925 - 960 | 18.00±0.5 | 0.25 | 31 | | |
| PDC | CP0402P1441AN | 1429 - 1453 | 14.50±0.5 | 0.40 | 28 | | |
| PCN | CP0402P1747AN | 1710 - 1785 | 13.00±0.5 | 0.50 | 26 | | |
| | CP0402P1842AN | 1805 - 1880 | 12.50±0.5 | 0.50 | 26 | | |
| PCS | CP0402P1880AN | 1850 - 1910 | 12.30±0.5 | 0.50 | 25 | | |
| | CP0402P1960AN | 1930 - 1990 | 12.00±0.5 | 0.50 | 25 | | |
| PHP | CP0402P1907AN | 1895 - 1920 | 12.30±0.5 | 0.50 | 25 | | |
| DECT | CP0402P1890AN | 1880 - 1900 | 12.30±0.5 | 0.50 | 25 | | |
| Wireless LAN | CP0402P2442AN | 2400 - 2484 | 10.30±0.5 | 0.70 | 23 | | |
| WiFi | CP0402P3500AN | 3450 - 3550 | 7.60±0.5 | 1.30 | 15 | | 14 |
| | CP0402P5000AN | 4950 - 5050 | 5.00±0.5 | 1.50 | 15 | | 13 |
| | CP0402P5500AN | 5450 - 5550 | 4.60±0.5 | 1.50 | 14 | | 13 |
| | CP0402P6000AN | 5950 - 6050 | 4.00±0.5 | 1.50 | 14 | | 13 |

CP0402PxxxxANTR

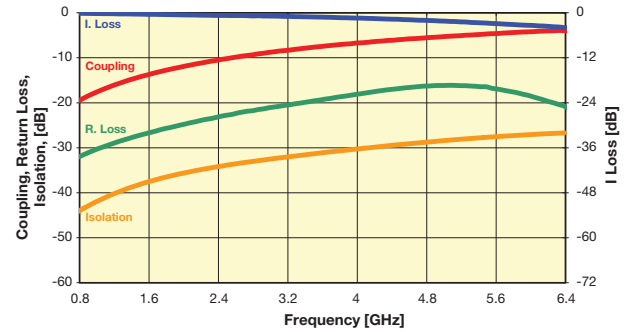

Coupler P/N CP0402PxxxxBN

| Application | P/N Examples | Frequency Band [MHz] | Coupling [dB] | I. Loss max. [dB] | Return Loss [dB] | Directivity [dB] | |
|--------------|---------------|----------------------|---------------|-------------------|------------------|------------------|----|
| AMPS | CP0402P0836BN | 824 - 849 | 22.00±0.5 | 0.20 | 28 | 27 | |
| | CP0402P0881BN | 869 - 894 | 21.70±0.5 | 0.20 | 28 | | |
| GSM | CP0402P0902BN | 890 - 915 | 21.50±0.5 | 0.20 | 28 | | |
| | CP0402P0947BN | 935 - 960 | 21.00±0.5 | 0.25 | 27 | | |
| E-GSM | CP0402P0897BN | 880 - 915 | 21.50±0.5 | 0.20 | 28 | | |
| | CP0402P0942BN | 925 - 960 | 21.00±0.5 | 0.25 | 27 | | |
| PDC | CP0402P1441BN | 1429 - 1453 | 17.50±0.5 | 0.25 | 24 | | |
| PCN | CP0402P1747BN | 1710 - 1785 | 16.00±0.5 | 0.30 | 23 | | |
| | CP0402P1842BN | 1805 - 1880 | 15.50±0.5 | 0.35 | 23 | | |
| PCS | CP0402P1880BN | 1850 - 1910 | 15.50±0.5 | 0.35 | 23 | | |
| | CP0402P1960BN | 1930 - 1990 | 15.00±0.5 | 0.35 | 22 | | |
| PHP | CP0402P1907BN | 1895 - 1920 | 15.50±0.5 | 0.35 | 23 | | |
| DECT | CP0402P1890BN | 1880 - 1900 | 15.50±0.5 | 0.35 | 23 | | |
| Wireless LAN | CP0402P2442BN | 2400 - 2484 | 13.30±0.5 | 0.40 | 21 | | |
| WiFi | CP0402P3500BN | 3450 - 3550 | 9.40±0.5 | 0.80 | 18 | | 14 |
| | CP0402P5000BN | 4950 - 5050 | 7.40±0.5 | 1.20 | 14 | | 13 |
| | CP0402P5500BN | 5450 - 5550 | 6.70±0.5 | 1.60 | 14 | | 13 |
| | CP0402P6000BN | 5950 - 6050 | 6.10±0.5 | 2.00 | 14 | | 13 |

CP0402PxxxxBNTR

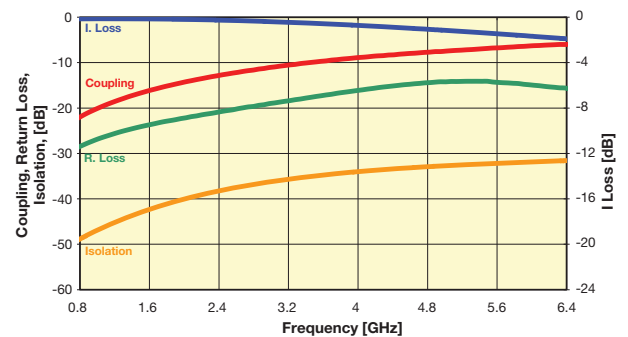

Coupler P/N CP0402PxxxxEN

| Application | P/N Examples | Frequency Band [MHz] | Coupling [dB] | I. Loss max. [dB] | Return Loss [dB] | Directivity [dB] | |
|--------------|---------------|----------------------|---------------|-------------------|------------------|------------------|----|
| AMPS | CP0402P0836EN | 824 - 849 | 27.20±0.5 | 0.20 | 35 | 25 | |
| | CP0402P0881EN | 869 - 894 | 26.80±0.5 | 0.20 | 34 | | |
| GSM | CP0402P0902EN | 890 - 915 | 26.50±0.5 | 0.20 | 34 | | |
| | CP0402P0947EN | 935 - 960 | 26.00±0.5 | 0.20 | 34 | | |
| E-GSM | CP0402P0897EN | 880 - 915 | 26.50±0.5 | 0.20 | 34 | | |
| | CP0402P0942EN | 925 - 960 | 26.00±0.5 | 0.20 | 34 | | |
| PDC | CP0402P1441EN | 1429 - 1453 | 22.30±0.5 | 0.25 | 29 | | |
| PCN | CP0402P1747EN | 1710 - 1785 | 20.50±0.5 | 0.25 | 27 | | |
| | CP0402P1842EN | 1805 - 1880 | 20.30±0.5 | 0.25 | 26 | | |
| PCS | CP0402P1880EN | 1850 - 1910 | 20.00±0.5 | 0.25 | 26 | | |
| | CP0402P1960EN | 1930 - 1990 | 20.00±0.5 | 0.25 | 26 | | |
| PHP | CP0402P1907EN | 1895 - 1920 | 20.00±0.5 | 0.25 | 26 | | |
| DECT | CP0402P1890EN | 1880 - 1900 | 20.00±0.5 | 0.25 | 26 | | |
| Wireless LAN | CP0402P2442EN | 2400 - 2484 | 18.00±0.5 | 0.35 | 23 | | |
| WiFi | CP0402P3500EN | 3450 - 3550 | 15.00±0.5 | 0.37 | 20 | | 16 |
| | CP0402P5000EN | 4950 - 5050 | 12.50±0.5 | 0.50 | 18 | | 13 |
| | CP0402P5500EN | 5450 - 5550 | 11.50±0.5 | 0.65 | 16 | | 13 |
| | CP0402P6000EN | 5950 - 6050 | 11.10±0.5 | 0.70 | 15 | | 13 |

CP0402PxxxxENTR

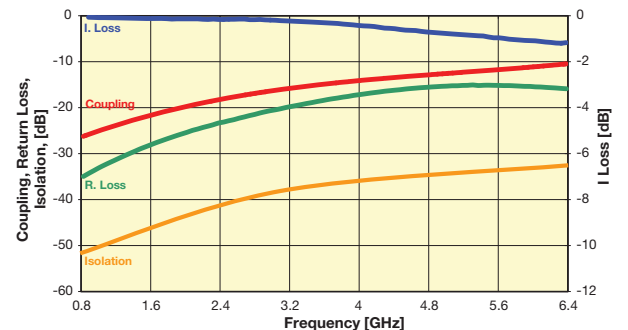

Thin-Film Directional Couplers



CP0402 High Directivity LGA Termination

GENERAL DESCRIPTION

ITF (Integrated Thin-Film) TECHNOLOGY

The ITF High Directivity LGA Coupler is based on thin-film multilayer technology. The technology provides a miniature part with excellent high frequency performance and rugged construction for reliable automatic assembly.

The ITF Coupler is offered in a variety of frequency bands compatible with various types of high frequency wireless systems.

APPLICATIONS

- Mobile Communications
- Satellite TV Receivers
- GPS
- Vehicle Location Systems
- Wireless LAN's

FEATURES

- Inherent Low Profile
- Self Alignment during Reflow
- Excellent Solderability
- Low Parasitics
- Better Heat Dissipation
- Operating/Storage Temp -40°C to +85°C
- Power Rating 3W RF Cont

DIMENSIONS: (Bottom View)

millimeters (inches)

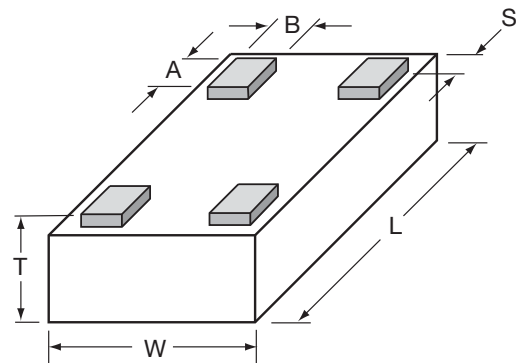

| | |
|---|----------------------------|
| L | 1.00±0.05 (0.040±0.002) |
| W | 0.58±0.04 (0.023±0.002) |
| T | 0.35±0.05 (0.014±0.002) |

| | |
|---|----------------------------|
| A | 0.20±0.05 (0.008±0.002) |
| B | 0.18±0.05 (0.007±0.002) |
| S | 0.05±0.05 (0.002±0.002) |

HOW TO ORDER

| | | | | | | |
|-------------------------|------------------|---------------|---------------------------|-----------------|---------------------------------------|-----------------------|
| CP T | 0402 T | X T | **** T | X T | N T | TR T |
| Style | Size | Type | Frequency (MHz) | Sub Type | LGA Termination | Packaging Code |
| Directional Coupler | 0402 | | | | L = LGA Sn90, Pb10 **N = LGA Sn100 | TR = Tape and Reel |
| **RoHS compliant | | | | | | |

QUALITY INSPECTION

Finished parts are 100% tested for electrical parameters and visual characteristics. Each production lot is evaluated on a sample basis for:

- Static Humidity: 85°C, 85% RH, 160 hours
- Endurance: 125°C, I_R, 4 hours

TERMINATION

Sn90Pb10 or Lead-Free Sn100 Nickel/Solder coating compatible with automatic soldering technologies: reflow, wave soldering, vapor phase and manual.

ORIENTATION IN TAPE

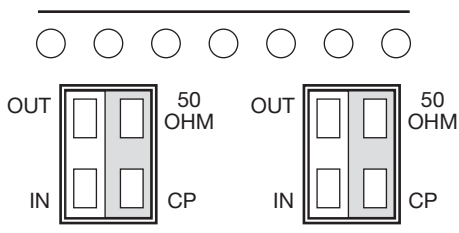

TERMINALS (Top View)

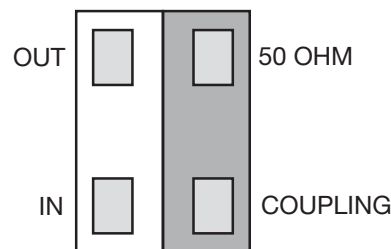

Not RoHS Compliant



For RoHS compliant products, please select correct termination style.

Recommended Pad Layout Dimensions

mm (inches)

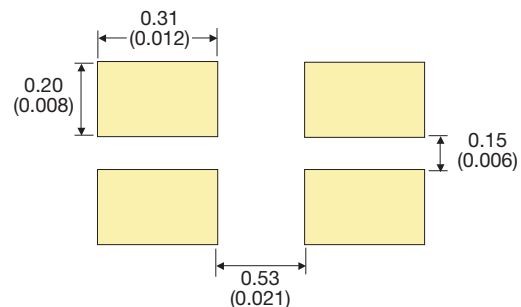

*The recommended distance to the PCB Ground Plane is 0.254mm (0.010")



CP0402 - TYPE SELECTION CHART

3

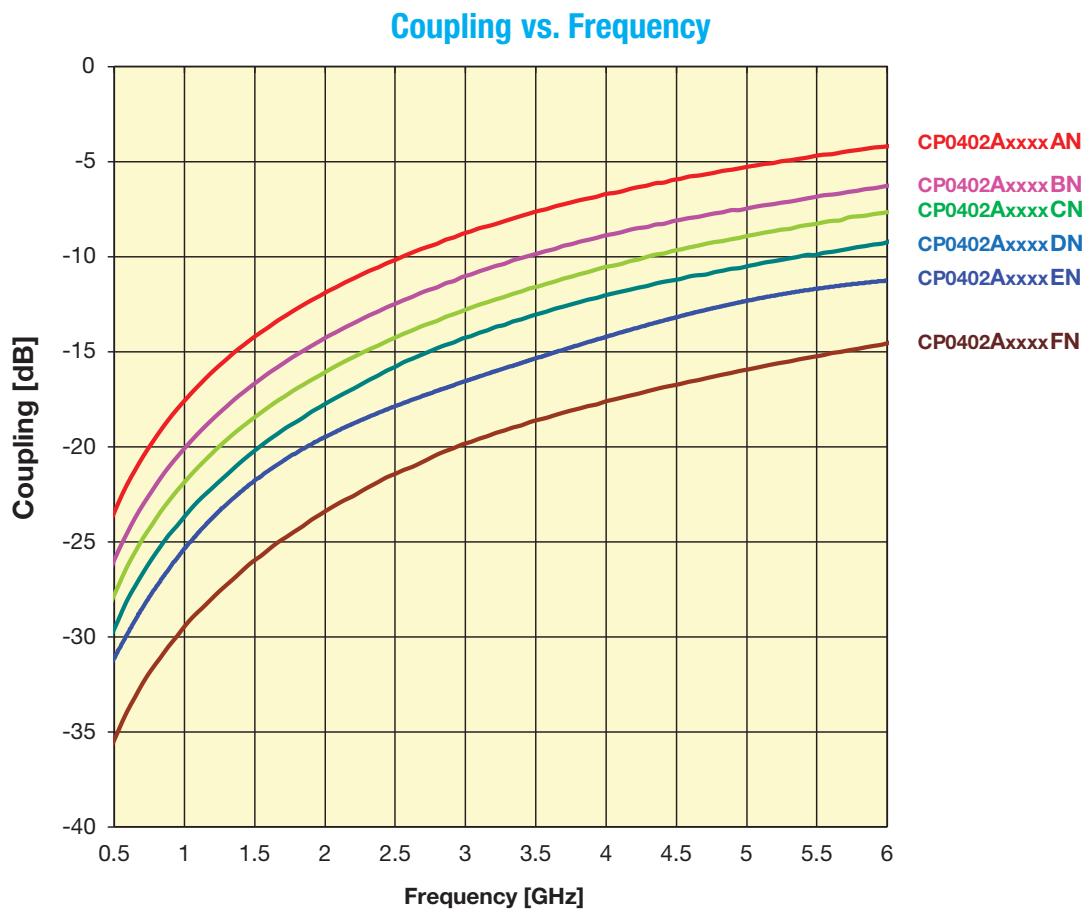

Intermediate coupling factors are readily available.
Please contact factory.

Thin-Film Directional Couplers



CP0402 High Directivity LGA Termination

Coupler P/N CP0402AxxxxAN

| Application | P/N Examples* | Frequency Band [MHz] | Coupling [dB] | I. Loss max. [dB] | Return Loss [dB] | Directivity [dB] | |
|--------------|---------------|----------------------|---------------|-------------------|------------------|------------------|----|
| AMPS | CP0402A0836AN | 824 - 849 | 19.10 | 0.25 | 32 | 21 | |
| | CP0402A0881AN | 869 - 894 | 18.60 | 0.25 | 31 | | |
| GSM | CP0402A0902AN | 890 - 915 | 18.50 | 0.25 | 31 | | |
| | CP0402A0947AN | 935 - 960 | 18.00 | 0.25 | 31 | | |
| E-GSM | CP0402A0897AN | 880 ÷ 915 | 18.50 | 0.25 | 31 | | |
| | CP0402A0942AN | 925 ÷ 960 | 18.00 | 0.25 | 31 | | |
| PDC | CP0402A1441AN | 1429 - 1453 | 14.50 | 0.40 | 28 | | |
| PCN | CP0402A1747AN | 1710 - 1785 | 13.00 | 0.50 | 26 | | |
| | CP0402A1842AN | 1805 - 1880 | 12.50 | 0.50 | 26 | | |
| PCS | CP0402A1880AN | 1850 - 1910 | 12.30 | 0.50 | 25 | | |
| | CP0402A1960AN | 1930 - 1990 | 12.00 | 0.50 | 25 | | |
| PHP | CP0402A1907AN | 1895 - 1920 | 12.30 | 0.50 | 25 | | |
| DECT | CP0402A1890AN | 1880 - 1900 | 12.30 | 0.50 | 25 | | |
| Wireless LAN | CP0402A2442AN | 2400 - 2484 | 10.30 | 0.70 | 23 | | |
| WiFi | CP0402A3500AN | 3450 - 3550 | 7.60 | 1.30 | 15 | | 14 |
| | CP0402A5000AN | 4950 - 5050 | 5.00 | 1.50 | 15 | | 13 |
| | CP0402A5500AN | 5450 - 5550 | 4.60 | 1.50 | 14 | 13 | |
| | CP0402A6000AN | 5950 - 6050 | 4.00 | 1.50 | 14 | 13 | |

CP0402AxxxxANTR

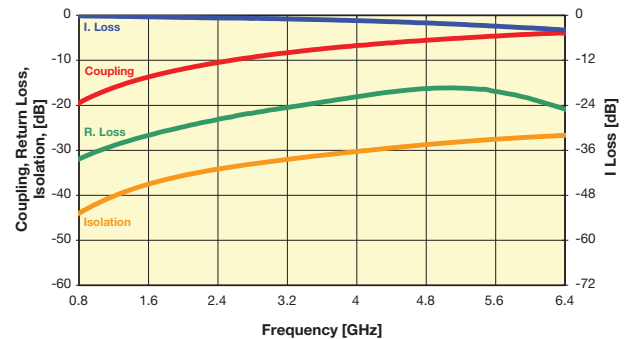

Coupler P/N CP0402AxxxxBN

| Application | P/N Examples | Frequency Band [MHz] | Coupling [dB] | I. Loss max. [dB] | Return Loss [dB] | Directivity [dB] | |
|--------------|---------------|----------------------|---------------|-------------------|------------------|------------------|----|
| AMPS | CP0402A0836BN | 824 - 849 | 22.00 | 0.20 | 28 | 27 | |
| | CP0402A0881BN | 869 - 894 | 21.70 | 0.20 | 28 | | |
| GSM | CP0402A0902BN | 890 - 915 | 21.50 | 0.20 | 28 | | |
| | CP0402A0947BN | 935 - 960 | 21.00 | 0.25 | 27 | | |
| E-GSM | CP0402A0897BN | 880 ÷ 915 | 21.50 | 0.20 | 28 | | |
| | CP0402A0942BN | 925 ÷ 960 | 21.00 | 0.25 | 27 | | |
| PDC | CP0402A1441BN | 1429 - 1453 | 17.50 | 0.25 | 24 | | |
| PCN | CP0402A1747BN | 1710 - 1785 | 16.00 | 0.30 | 23 | | |
| | CP0402A1842BN | 1805 - 1880 | 15.50 | 0.35 | 23 | | |
| PCS | CP0402A1880BN | 1850 - 1910 | 15.50 | 0.35 | 23 | | |
| | CP0402A1960BN | 1930 - 1990 | 15.00 | 0.35 | 22 | | |
| PHP | CP0402A1907BN | 1895 - 1920 | 15.50 | 0.35 | 23 | | |
| DECT | CP0402A1890BN | 1880 - 1900 | 15.50 | 0.35 | 23 | | |
| Wireless LAN | CP0402A2442BN | 2400 - 2484 | 13.30 | 0.40 | 21 | | |
| WiFi | CP0402A3500BN | 3450 - 3550 | 9.40 | 0.80 | 18 | | 14 |
| | CP0402A5000BN | 4950 - 5050 | 7.40 | 1.20 | 14 | | 13 |
| | CP0402A5500BN | 5450 - 5550 | 6.70 | 1.60 | 14 | 13 | |
| | CP0402A6000BN | 5950 - 6050 | 6.10 | 2.00 | 14 | 13 | |

CP0402AxxxxBNTR

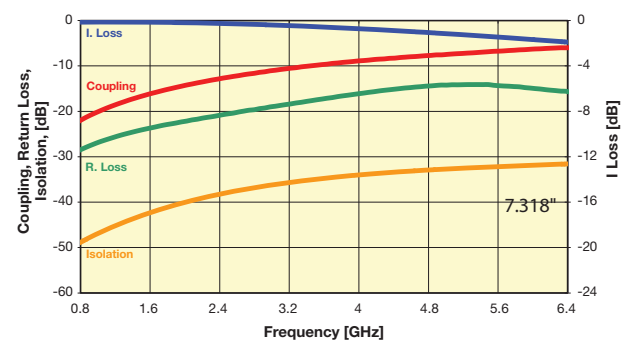

Coupler P/N CP0402AxxxxCN

| Application | P/N Examples | Frequency Band [MHz] | Coupling [dB] | I. Loss max. [dB] | Return Loss [dB] | Directivity [dB] | |
|--------------|---------------|----------------------|---------------|-------------------|------------------|------------------|----|
| AMPS | CP0402A0836CN | 824 - 849 | 23.60 | 0.20 | 33 | 22 | |
| | CP0402A0881CN | 869 - 894 | 23.00 | 0.20 | 33 | | |
| GSM | CP0402A0902CN | 890 - 915 | 23.00 | 0.20 | 26 | | |
| | CP0402A0947CN | 935 - 960 | 22.50 | 0.20 | 33 | | |
| E-GSM | CP0402A0897CN | 880 ÷ 915 | 23.00 | 0.20 | 25 | | |
| | CP0402A0942CN | 925 ÷ 960 | 22.50 | 0.20 | 32 | | |
| PDC | CP0402A1441CN | 1429 - 1453 | 19.00 | 0.25 | 31 | | |
| PCN | CP0402A1747CN | 1710 - 1785 | 17.20 | 0.25 | 30 | | |
| | CP0402A1842CN | 1805 - 1880 | 17.00 | 0.25 | 30 | | |
| PCS | CP0402A1880CN | 1850 - 1910 | 16.80 | 0.25 | 30 | | |
| | CP0402A1960CN | 1930 - 1990 | 16.50 | 0.25 | 29 | | |
| PHP | CP0402A1907CN | 1895 - 1920 | 16.80 | 0.25 | 29 | | |
| DECT | CP0402A1890CN | 1880 - 1900 | 16.80 | 0.25 | 30 | | |
| Wireless LAN | CP0402A2442CN | 2400 - 2484 | 14.70 | 0.45 | 28 | | |
| WiFi | CP0402A3500CN | 3450 - 3550 | 10.97 | 0.67 | 23 | | 17 |
| | CP0402A5000CN | 4950 - 5050 | 8.00 | 1.00 | 21 | | 16 |
| | CP0402A5500CN | 5450 - 5550 | 7.50 | 1.10 | 21 | 15 | |
| | CP0402A6000CN | 5950 - 6050 | 7.10 | 1.30 | 23 | 15 | |

CP0402AxxxxCNTR

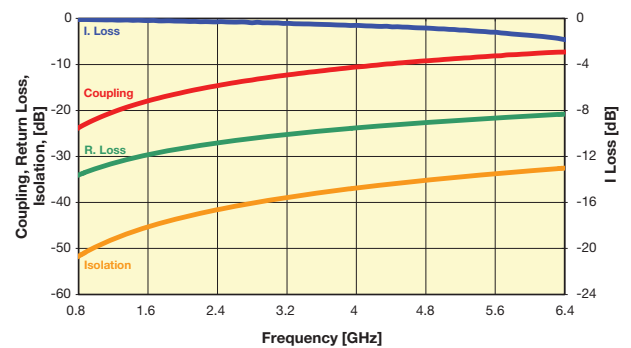

Important: Couplers can be used at any frequency within the indicated range.



Thin-Film Directional Couplers



CP0402 High Directivity LGA Termination

Coupler P/N CP0402AxxxxDN

| Application | P/N Examples* | Frequency Band [MHz] | Coupling [dB] | I. Loss max. [dB] | Return Loss [dB] | Directivity [dB] | |
|--------------|---------------|----------------------|---------------|-------------------|------------------|------------------|----|
| AMPS | CP0402A0836DN | 824 - 849 | 25.20 | 0.20 | 29 | 20 | |
| | CP0402A0881DN | 869 - 894 | 24.80 | 0.20 | 28 | | |
| GSM | CP0402A0902DN | 890 - 915 | 24.70 | 0.20 | 28 | | |
| | CP0402A0947DN | 935 - 960 | 24.10 | 0.20 | 28 | | |
| E-GSM | CP0402A0897DN | 880 ÷ 915 | 24.70 | 0.20 | 28 | | |
| | CP0402A0942DN | 925 ÷ 960 | 24.10 | 0.20 | 28 | | |
| PDC | CP0402A1441DN | 1429 - 1453 | 20.50 | 0.20 | 25 | | 18 |
| PCN | CP0402A1747DN | 1710 - 1785 | 19.00 | 0.20 | 24 | | |
| | CP0402A1842DN | 1805 - 1880 | 18.50 | 0.25 | 23 | | |
| PCS | CP0402A1880DN | 1850 - 1910 | 18.20 | 0.25 | 23 | | |
| | CP0402A1960DN | 1930 - 1990 | 18.00 | 0.25 | 23 | | |
| PHP | CP0402A1907DN | 1895 - 1920 | 18.10 | 0.25 | 23 | | |
| DECT | CP0402A1890DN | 1880 - 1900 | 18.20 | 0.25 | 23 | | |
| Wireless LAN | CP0402A2442DN | 2400 - 2484 | 16.00 | 0.35 | 22 | | |
| WiFi | CP0402A3500DN | 3450 - 3550 | 12.50 | 0.46 | 21 | 17 | |
| | CP0402A5000DN | 4950 - 5050 | 10.00 | 0.65 | 21 | 16 | |
| | CP0402A5500DN | 5450 - 5550 | 9.60 | 0.76 | 20 | 15 | |
| | CP0402A6000DN | 5950 - 6050 | 9.10 | 0.84 | 20 | 15 | |

CP0402AxxxxDNTR

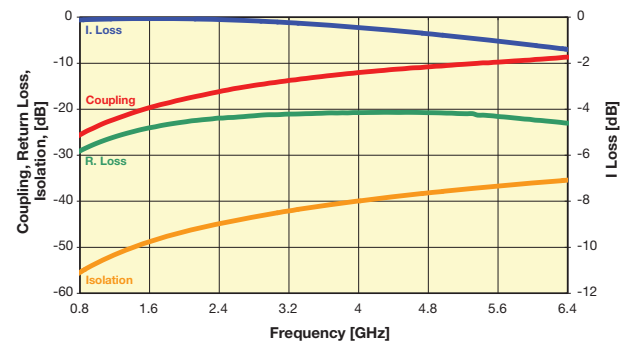

Coupler P/N CP0402AxxxxEN

| Application | P/N Examples | Frequency Band [MHz] | Coupling [dB] | I. Loss max. [dB] | Return Loss [dB] | Directivity [dB] | |
|--------------|---------------|----------------------|---------------|-------------------|------------------|------------------|----|
| AMPS | CP0402A0836EN | 824 - 849 | 27.20 | 0.20 | 35 | 25 | |
| | CP0402A0881EN | 869 - 894 | 26.80 | 0.20 | 34 | | |
| GSM | CP0402A0902EN | 890 - 915 | 26.50 | 0.20 | 34 | | |
| | CP0402A0947EN | 935 - 960 | 26.00 | 0.20 | 34 | | |
| E-GSM | CP0402A0897EN | 880 ÷ 915 | 26.50 | 0.20 | 34 | | |
| | CP0402A0942EN | 925 ÷ 960 | 26.00 | 0.20 | 34 | | |
| PDC | CP0402A1441EN | 1429 - 1453 | 22.30 | 0.25 | 29 | | 23 |
| PCN | CP0402A1747EN | 1710 - 1785 | 20.50 | 0.25 | 27 | | |
| | CP0402A1842EN | 1805 - 1880 | 20.30 | 0.25 | 26 | | |
| PCS | CP0402A1880EN | 1850 - 1910 | 20.00 | 0.25 | 26 | | |
| | CP0402A1960EN | 1930 - 1990 | 20.00 | 0.25 | 26 | | |
| PHP | CP0402A1907EN | 1895 - 1920 | 20.00 | 0.25 | 26 | | |
| DECT | CP0402A1890EN | 1880 - 1900 | 20.00 | 0.25 | 26 | | |
| Wireless LAN | CP0402A2442EN | 2400 - 2484 | 18.00 | 0.35 | 23 | | |
| WiFi | CP0402A3500EN | 3450 - 3550 | 15.00 | 0.37 | 20 | 16 | |
| | CP0402A5000EN | 4950 - 5050 | 12.50 | 0.50 | 18 | 13 | |
| | CP0402A5500EN | 5450 - 5550 | 11.50 | 0.65 | 16 | 13 | |
| | CP0402A6000EN | 5950 - 6050 | 11.10 | 0.70 | 15 | 13 | |

CP0402AxxxxENTR

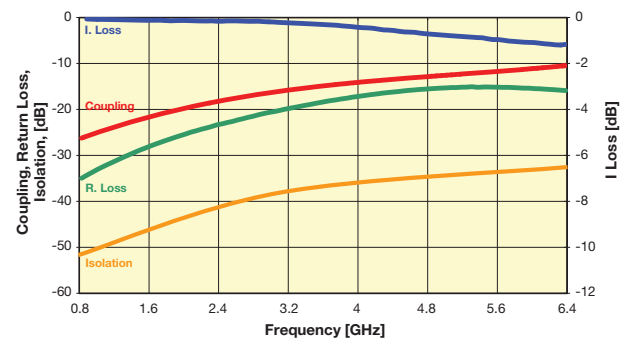

Coupler P/N CP0402AxxxxFN

| Application | P/N Examples | Frequency Band [MHz] | Coupling [dB] | I. Loss max. [dB] | Return Loss [dB] | Directivity [dB] | |
|--------------|---------------|----------------------|---------------|-------------------|------------------|------------------|---|
| AMPS | CP0402A0836FN | 824 - 849 | 31.00 | 0.20 | 29.10 | 11 | |
| | CP0402A0881FN | 869 - 894 | 30.70 | 0.20 | 28.60 | | |
| GSM | CP0402A0902FN | 890 - 915 | 30.60 | 0.20 | 28.50 | | |
| | CP0402A0947FN | 935 - 960 | 30.00 | 0.20 | 28.10 | | |
| E-GSM | CP0402A0897FN | 880 ÷ 915 | 30.60 | 0.20 | 28.50 | | |
| | CP0402A0942FN | 925 ÷ 960 | 30.00 | 0.20 | 28.10 | | |
| PDC | CP0402A1441FN | 1429 - 1453 | 26.50 | 0.20 | 25.00 | | 9 |
| PCN | CP0402A1747FN | 1710 - 1785 | 25.00 | 0.20 | 23.80 | | |
| | CP0402A1842FN | 1805 - 1880 | 24.50 | 0.20 | 23.60 | | |
| PCS | CP0402A1880FN | 1850 - 1910 | 24.20 | 0.20 | 23.50 | | |
| | CP0402A1960FN | 1930 - 1990 | 24.00 | 0.20 | 23.30 | | |
| PHP | CP0402A1907FN | 1895 - 1920 | 24.20 | 0.20 | 23.40 | | |
| DECT | CP0402A1890FN | 1880 - 1900 | 24.20 | 0.20 | 23.50 | | |
| Wireless LAN | CP0402A2442FN | 2400 - 2484 | 22.00 | 0.25 | 22.60 | | |
| WiFi | CP0402A3500FN | 3450 - 3550 | 18.00 | 0.27 | 22.00 | 9 | |
| | CP0402A5000FN | 4950 - 5050 | 15.70 | 0.30 | 23.01 | 8 | |
| | CP0402A5500FN | 5450 - 5550 | 15.20 | 0.30 | 20.36 | 7.5 | |
| | CP0402A6000FN | 5950 - 6050 | 14.50 | 0.30 | 18.94 | 7.5 | |

CP0402AxxxxFNTR

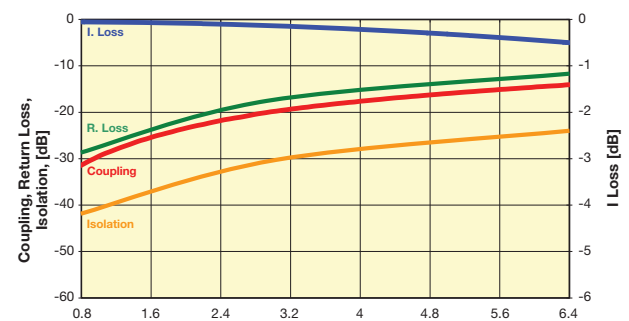

Important: Couplers can be used at any frequency within the indicated range.



Thin-Film Directional Couplers



CP0603 High Directivity LGA Termination

GENERAL DESCRIPTION ITF (Integrated Thin-Film) TECHNOLOGY

The ITF LGA Coupler is based on thin-film multilayer technology. The technology provides a miniature part with excellent high frequency performance and rugged construction for reliable automatic assembly. The ITF Coupler is offered in a variety of frequency bands compatible with various types of high frequency wireless systems.

APPLICATIONS

- Mobile Communications
- Satellite TV Receivers
- GPS
- Vehicle Location Systems
- Wireless LAN's

FEATURES

- Inherent Low Profile
- Self Alignment during Reflow
- Excellent Solderability
- Low Parasitics
- Better Heat Dissipation
- Operating/Storage Temp -40°C to +85°C
- Power Rating 3W RF Cont

HOW TO ORDER

| | | | | | | |
|---|---|------------------------------|---|----------------------------------|---|---|
| CP T Style Directional Coupler | 0603 T Size 0603 | X T Type | **** T Frequency (MHz) | X T Sub Type | N T Termination Code L = LGA Sn90, Pb10 **N = LGA Sn100 | TR T Packaging Code TR = Tape and Reel |
|---|---|------------------------------|---|----------------------------------|---|---|

****RoHS compliant**

QUALITY INSPECTION

Finished parts are 100% tested for electrical parameters and visual characteristics. Each production lot is evaluated on a sample basis for:

- Static Humidity: 85°C, 85% RH, 160 hours
- Endurance: 125°C, I_R, 4 hours

TERMINATION

Sn90Pb10 or Lead-Free Sn100 Nickel/Solder coating compatible with automatic soldering technologies: reflow, wave soldering, vapor phase and manual.

ORIENTATION IN TAPE

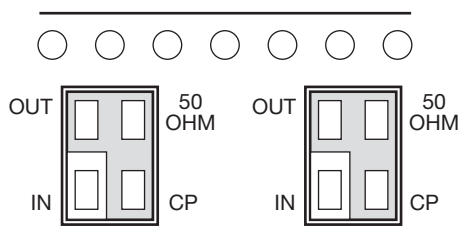

DIMENSIONS: (Bottom View)

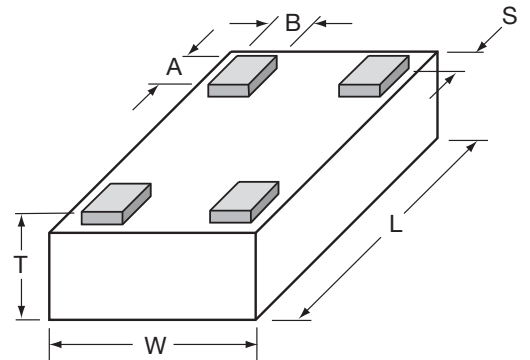

| | | | |
|----------|----------------------------|----------|----------------------------|
| L | 1.60±0.10 (0.063±0.004) | A | 0.25±0.05 (0.010±0.002) |
| W | 0.84±0.10 (0.033±0.004) | B | 0.20±0.05 (0.008±0.002) |
| T | 0.60±0.10 (0.024±0.004) | S | 0.05±0.05 (0.002±0.002) |

TERMINALS (Top View)

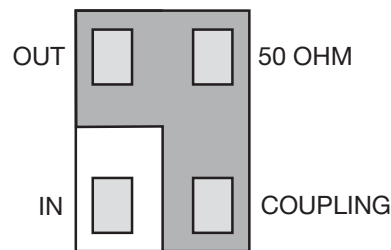

Not RoHS Compliant



For RoHS compliant products,
please select correct termination style.

Recommended Pad Layout Dimensions

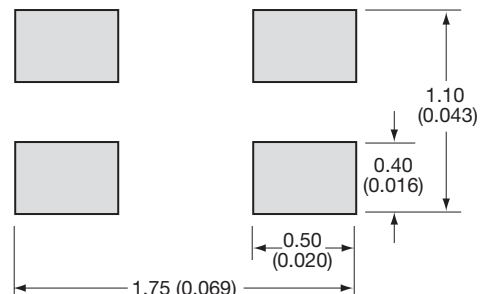

*The recommended distance to the PCB Ground Plane is 0.254mm (0.010")



Thin-Film Directional Couplers



CP0603 High Directivity LGA Termination

CP0603 - TYPE SELECTION CHART

Coupling vs. Frequency

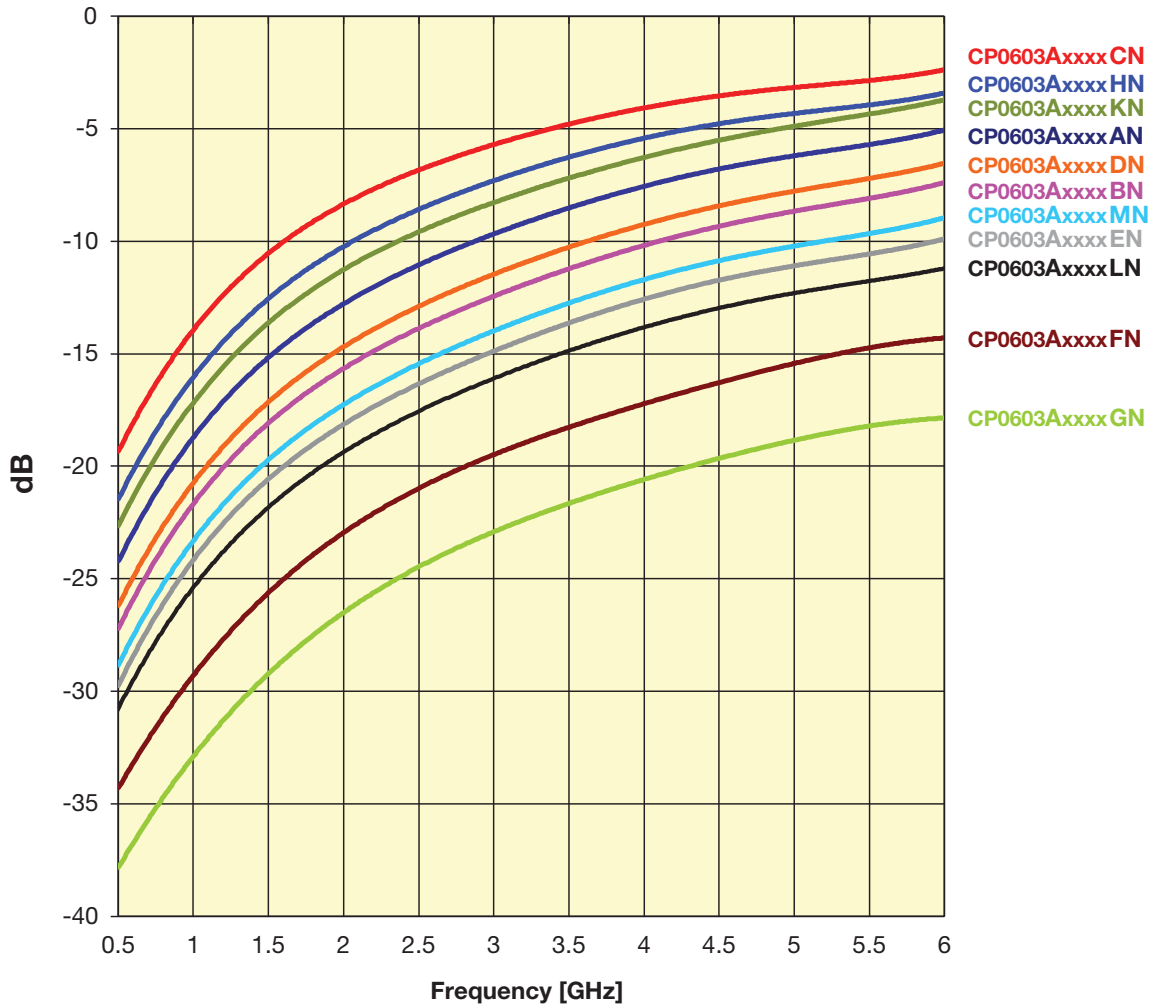

Intermediate coupling factors are readily available.
Please contact factory.

3

Thin-Film Directional Couplers



CP0603 High Directivity LGA Type

Coupler P/N CP0603AxxxxAN

| Application | P/N Examples* | Frequency Band [MHz] | Coupling [dB] | I. Loss max. [dB] | Return Loss [dB] | Directivity [dB] |
|--------------|---------------|----------------------|---------------|-------------------|------------------|------------------|
| AMPS | CP0603A0836AN | 824 - 849 | 20.0 | 0.25 | 28 | 22 |
| | CP0603A0881AN | 869 - 894 | 19.7 | 0.25 | 28 | |
| GSM | CP0603A0902AN | 890 - 915 | 19.4 | 0.25 | 27 | |
| | CP0603A0947AN | 935 - 960 | 19.0 | 0.25 | 27 | |
| E-GSM | CP0603A0897AN | 880 - 915 | 19.4 | 0.25 | 28 | |
| | CP0603A0942AN | 925 - 960 | 19.0 | 0.25 | 27 | |
| PDC | CP0603A1441AN | 1429 - 1453 | 15.5 | 0.40 | 24 | |
| PCN | CP0603A1747AN | 1710 - 1785 | 14.0 | 0.50 | 22 | |
| | CP0603A1842AN | 1805 - 1880 | 13.5 | 0.50 | 22 | |
| PCS | CP0603A1880AN | 1850 - 1910 | 13.2 | 0.50 | 22 | |
| | CP0603A1960AN | 1930 - 1990 | 13.0 | 0.55 | 21 | |
| PHP | CP0603A1907AN | 1895 - 1920 | 13.2 | 0.50 | 22 | |
| DECT | CP0603A1890AN | 1880 - 1900 | 13.2 | 0.50 | 22 | |
| Wireless LAN | CP0603A2442AN | 2400 - 2484 | 11.5 | 0.75 | 20 | |
| WiFi | CP0603A3500AN | 3450 - 3550 | 8.6 | 1.3 | 17 | 20 |
| | CP0603A5000AN | 4950 - 5050 | 6.1 | 2.2 | 13 | 14 |
| | CP0603A5500AN | 5450 - 5550 | 5.5 | 2.5 | 15 | 13 |
| | CP0603A6000AN | 5950 - 6050 | 5 | 3 | 11.6 | 13 |

CP0603AxxxxANTR

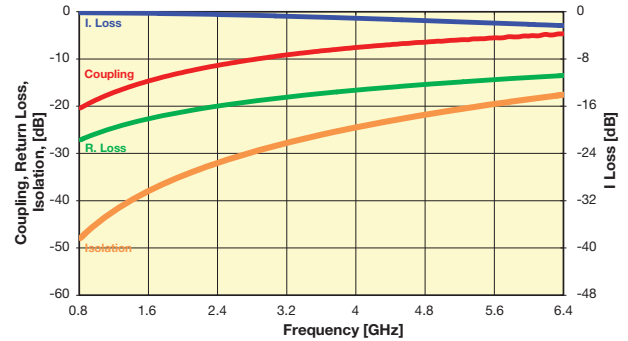

Coupler P/N CP0603AxxxxBN

| Application | P/N Examples* | Frequency Band [MHz] | Coupling [dB] | I. Loss max. [dB] | Return Loss [dB] | Directivity [dB] |
|--------------|---------------|----------------------|---------------|-------------------|------------------|------------------|
| AMPS | CP0603A0836BN | 824 - 849 | 23.0 | 0.20 | 31 | 24 |
| | CP0603A0881BN | 869 - 894 | 22.7 | 0.20 | 31 | |
| GSM | CP0603A0902BN | 890 - 915 | 22.5 | 0.20 | 31 | |
| | CP0603A0947BN | 935 - 960 | 22.0 | 0.20 | 30 | |
| E-GSM | CP0603A0897BN | 880 - 915 | 22.5 | 0.20 | 31 | |
| | CP0603A0942BN | 925 - 960 | 22.0 | 0.20 | 30 | |
| PDC | CP0603A1441BN | 1429 - 1453 | 18.5 | 0.25 | 27 | |
| PCN | CP0603A1747BN | 1710 - 1785 | 17.0 | 0.25 | 25 | |
| | CP0603A1842BN | 1805 - 1880 | 16.4 | 0.25 | 25 | |
| PCS | CP0603A1880BN | 1850 - 1910 | 16.2 | 0.25 | 25 | |
| | CP0603A1960BN | 1930 - 1990 | 16.0 | 0.25 | 24 | |
| PHP | CP0603A1907BN | 1895 - 1920 | 16.1 | 0.25 | 25 | |
| DECT | CP0603A1890BN | 1880 - 1900 | 16.2 | 0.25 | 25 | |
| Wireless LAN | CP0603A2442BN | 2400 - 2484 | 14.2 | 0.35 | 23 | |
| WiFi | CP0603A3500BN | 3450 - 3550 | 11.2 | 0.6 | 20 | 20 |
| | CP0603A5000BN | 4950 - 5050 | 8.4 | 1.1 | 16.7 | 17 |
| | CP0603A5500BN | 5450 - 5550 | 7.8 | 1.4 | 15.7 | 16 |
| | CP0603A6000BN | 5950 - 6050 | 7.2 | 1.6 | 15 | 15 |

CP0603AxxxxBNTR

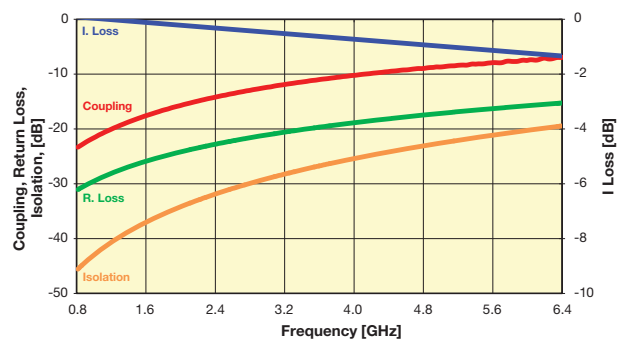

Coupler P/N CP0603AxxxxCN

| Application | P/N Examples* | Frequency Band [MHz] | Coupling [dB] | I. Loss max. [dB] | Return Loss [dB] | Directivity [dB] |
|--------------|---------------|----------------------|---------------|-------------------|------------------|------------------|
| AMPS | CP0603A0836CN | 824 - 849 | 15.2 | 0.35 | 23 | 23 |
| | CP0603A0881CN | 869 - 894 | 15.0 | 0.35 | 23 | |
| GSM | CP0603A0902CN | 890 - 915 | 14.7 | 0.35 | 23 | |
| | CP0603A0947CN | 935 - 960 | 14.3 | 0.40 | 22 | |
| E-GSM | CP0603A0897CN | 880 - 915 | 14.7 | 0.35 | 23 | |
| | CP0603A0942CN | 925 - 960 | 14.3 | 0.40 | 22 | |
| PDC | CP0603A1441CN | 1429 - 1453 | 11.0 | 0.70 | 19 | |
| PCN | CP0603A1747CN | 1710 - 1785 | 9.5 | 0.80 | 18 | |
| | CP0603A1842CN | 1805 - 1880 | 9.0 | 0.90 | 17 | |
| PCS | CP0603A1880CN | 1850 - 1910 | 8.8 | 0.90 | 17 | |
| | CP0603A1960CN | 1930 - 1990 | 8.5 | 1.00 | 17 | |
| PHP | CP0603A1907CN | 1895 - 1920 | 8.8 | 0.90 | 17 | |
| DECT | CP0603A1890CN | 1880 - 1900 | 8.8 | 0.90 | 17 | |
| Wireless LAN | CP0603A2442CN | 2400 - 2484 | 7.0 | 1.40 | 15 | |
| WiFi | CP0603A3500CN | 3450 - 3550 | 4.8 | 2.0 | 23 | 20 |
| | CP0603A5000CN | 4950 - 5050 | 3.0 | 3.6 | 21 | 17 |
| | CP0603A5500CN | 5450 - 5550 | 3.0 | 4.0 | 20.6 | 16 |
| | CP0603A6000CN | 5950 - 6050 | 2.5 | 4.5 | 20.5 | 16 |

CP0603AxxxxCNTR

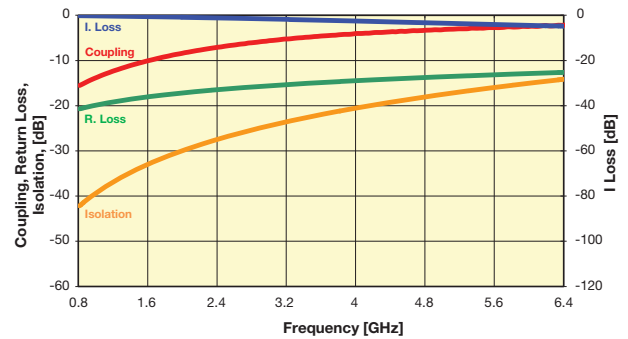

Important: Couplers can be used at any frequency within the indicated range.



Thin-Film Directional Couplers



CP0603 High Directivity LGA Type

Coupler P/N CP0603AxxxxDN

| Application | P/N Examples* | Frequency Band [MHz] | Coupling [dB] | I. Loss max. [dB] | Return Loss [dB] | Directivity [dB] | |
|--------------|---------------|----------------------|---------------|-------------------|------------------|------------------|----|
| AMPS | CP0603A0836DN | 824 - 849 | 22.0 | 0.25 | 31 | 30 | |
| | CP0603A0881DN | 869 - 894 | 21.8 | 0.25 | 30 | | |
| GSM | CP0603A0902DN | 890 - 915 | 21.3 | 0.25 | 30 | | |
| | CP0603A0947DN | 935 - 960 | 21.0 | 0.30 | 30 | | |
| E-GSM | CP0603A0897DN | 880 - 915 | 21.3 | 0.25 | 30 | | |
| | CP0603A0942DN | 925 - 960 | 21.0 | 0.30 | 30 | | |
| PDC | CP0603A1441DN | 1429 - 1453 | 17.7 | 0.40 | 27 | | 25 |
| PCN | CP0603A1747DN | 1710 - 1785 | 16.0 | 0.40 | 25 | | |
| | CP0603A1842DN | 1805 - 1880 | 15.4 | 0.40 | 25 | | |
| PCS | CP0603A1880DN | 1850 - 1910 | 15.2 | 0.40 | 24 | | |
| | CP0603A1960DN | 1930 - 1990 | 15.0 | 0.40 | 24 | | |
| PHP | CP0603A1907DN | 1895 - 1920 | 15.2 | 0.40 | 24 | | |
| DECT | CP0603A1890DN | 1880 - 1900 | 15.2 | 0.40 | 24 | | |
| Wireless LAN | CP0603A2442DN | 2400 - 2484 | 13.3 | 0.55 | 22 | | |
| WiFi | CP0603A3500DN | 3450 - 3550 | 10.1 | 0.66 | 25.3 | 20 | |
| | CP0603A5000DN | 4950 - 5050 | 7.8 | 1.17 | 21.1 | 18 | |
| | CP0603A5500DN | 5450 - 5550 | 6.8 | 1.39 | 19.9 | 18 | |
| | CP0603A6000DN | 5950 - 6050 | 6.3 | 1.64 | 18.8 | 17 | |

CP0603AxxxxDNTR

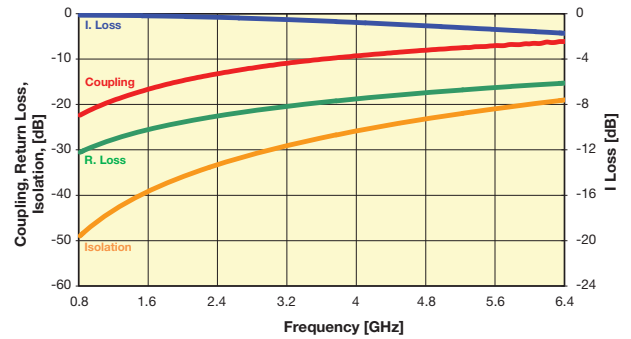

Coupler P/N CP603AxxxxEN

| Application | P/N Examples* | Frequency Band [MHz] | Coupling [dB] | I. Loss max. [dB] | Return Loss [dB] | Directivity [dB] | |
|--------------|---------------|----------------------|---------------|-------------------|------------------|------------------|----|
| AMPS | CP0603A0836EN | 824 - 849 | 25.8 | 0.20 | 32 | 21 | |
| | CP0603A0881EN | 869 - 894 | 25.3 | 0.20 | 32 | | |
| GSM | CP0603A0902EN | 890 - 915 | 25.0 | 0.20 | 32 | | |
| | CP0603A0947EN | 935 - 960 | 24.7 | 0.20 | 31 | | |
| E-GSM | CP0603A0897EN | 880 - 915 | 26.0 | 0.20 | 32 | | |
| | CP0603A0942EN | 925 - 960 | 24.7 | 0.20 | 31 | | |
| PDC | CP0603A1441EN | 1429 - 1453 | 22.0 | 0.25 | 28 | | 20 |
| PCN | CP0603A1747EN | 1710 - 1785 | 19.5 | 0.30 | 26 | | |
| | CP0603A1842EN | 1805 - 1880 | 19.0 | 0.30 | 26 | | |
| PCS | CP0603A1880EN | 1850 - 1910 | 18.8 | 0.30 | 26 | | |
| | CP0603A1960EN | 1930 - 1990 | 18.5 | 0.30 | 26 | | |
| PHP | CP0603A1907EN | 1895 - 1920 | 18.7 | 0.30 | 26 | | |
| DECT | CP0603A1890EN | 1880 - 1900 | 18.8 | 0.30 | 26 | | |
| Wireless LAN | CP0603A2442EN | 2400 - 2484 | 17.0 | 0.40 | 24 | | |
| WiFi | CP0603A3500EN | 3450 - 3550 | 13.2 | 0.5 | 18 | 16 | |
| | CP0603A5000EN | 4950 - 5050 | 10.7 | 0.9 | 13 | 16 | |
| | CP0603A5500EN | 5450 - 5550 | 10.2 | 1.2 | 12 | 15 | |
| | CP0603A6000EN | 5950 - 6050 | 9.7 | 1.4 | 12 | 14 | |

CP0603AxxxxENTR

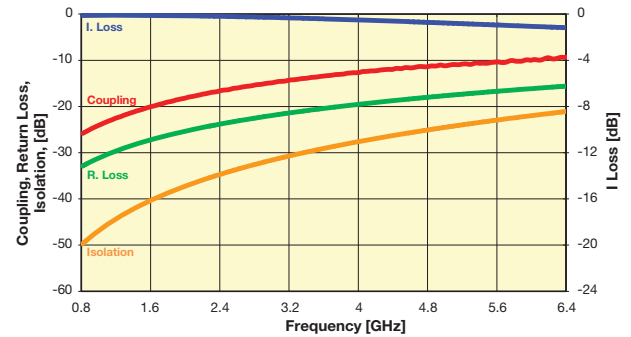

Coupler P/N CP603AxxxxFN

| Application | P/N Examples* | Frequency Band [MHz] | Coupling [dB] | I. Loss max. [dB] | Return Loss [dB] | Directivity [dB] | |
|--------------|---------------|----------------------|---------------|-------------------|------------------|------------------|----|
| AMPS | CP0603A0836FN | 824 - 849 | 31.2 | 0.20 | 32 | 12 | |
| | CP0603A0881FN | 869 - 894 | 30.8 | 0.20 | 32 | | |
| GSM | CP0603A0902FN | 890 - 915 | 30.5 | 0.20 | 30 | | |
| | CP0603A0947FN | 935 - 960 | 30.2 | 0.20 | 30 | | |
| E-GSM | CP0603A0897FN | 880 - 915 | 30.5 | 0.20 | 30 | | |
| | CP0603A0942FN | 925 - 960 | 30.2 | 0.20 | 30 | | |
| PDC | CP0603A1441FN | 1429 - 1453 | 27.0 | 0.25 | 28 | | 13 |
| PCN | CP0603A1747FN | 1710 - 1785 | 25.0 | 0.25 | 27 | | |
| | CP0603A1842FN | 1805 - 1880 | 26.5 | 0.25 | 27 | | |
| PCS | CP0603A1880FN | 1850 - 1910 | 24.3 | 0.25 | 27 | | |
| | CP0603A1960FN | 1930 - 1990 | 24.0 | 0.25 | 28 | | |
| PHP | CP0603A1907FN | 1895 - 1920 | 24.2 | 0.25 | 27 | | |
| DECT | CP0603A1890FN | 1880 - 1900 | 24.2 | 0.25 | 27 | | |
| Wireless LAN | CP0603A2442FN | 2400 - 2484 | 21.5 | 0.25 | 25 | | |
| WiFi | CP0603A3500FN | 3450 - 3550 | 17.8 | 0.33 | 20.0 | 12 | |
| | CP0603A5000FN | 4950 - 5050 | 15.4 | 0.62 | 14.86 | 12 | |
| | CP0603A5500FN | 5450 - 5550 | 14.8 | 0.86 | 13.58 | 12 | |
| | CP0603A6000FN | 5950 - 6050 | 14.3 | 1.02 | 12.58 | 11 | |

CP0603AxxxxFNTR

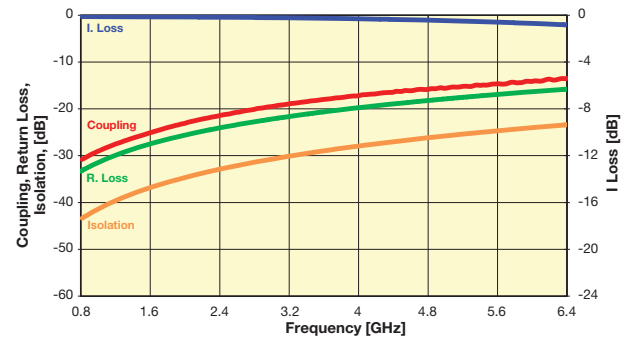

Important: Couplers can be used at any frequency within the indicated range.



Thin-Film Directional Couplers



CP0603 High Directivity LGA Type

Coupler P/N CP603AxxxxGN

| Application | P/N Examples* | Frequency Band [MHz] | Coupling [dB] | I. Loss max. [dB] | Return Loss [dB] | Directivity [dB] |
|--------------|---------------|----------------------|---------------|-------------------|------------------|------------------|
| AMPS | CP0603A0836GN | 824 - 849 | 34.2 | 0.20 | 30 | 13 |
| | CP0603A0881GN | 869 - 894 | 33.8 | 0.20 | 30 | |
| GSM | CP0603A0902GN | 890 - 915 | 33.6 | 0.20 | 30 | |
| | CP0603A0947GN | 935 - 960 | 33.2 | 0.20 | 29 | |
| E-GSM | CP0603A0897GN | 880 - 915 | 33.6 | 0.20 | 30 | |
| | CP0603A0942GN | 925 - 960 | 33.2 | 0.20 | 29 | |
| PDC | CP0603A1441GN | 1429 - 1453 | 30.0 | 0.25 | 25 | |
| PCN | CP0603A1747GN | 1710 - 1785 | 28.5 | 0.25 | 24 | |
| | CP0603A1842GN | 1805 - 1880 | 28.0 | 0.25 | 24 | |
| PCS | CP0603A1880GN | 1850 - 1910 | 27.7 | 0.25 | 24 | |
| | CP0603A1960GN | 1930 - 1990 | 27.5 | 0.25 | 23 | |
| PHP | CP0603A1907GN | 1895 - 1920 | 27.6 | 0.25 | 24 | |
| DECT | CP0603A1890GN | 1880 - 1900 | 27.7 | 0.25 | 24 | |
| Wireless LAN | CP0603A2442GN | 2400 - 2484 | 25.5 | 0.25 | 22 | |
| WiFi | CP0603A3500GN | 3450 - 3550 | 21.6 | 0.31 | 20 | 13 |
| | CP0603A5000GN | 4950 - 5050 | 19 | 0.39 | 16 | 12 |
| | CP0603A5500GN | 5450 - 5550 | 18.5 | 0.57 | 15 | 12 |
| | CP0603A6000GN | 5950 - 6050 | 18.0 | 0.74 | 14 | 11 |

CP0603AxxxxGNTR

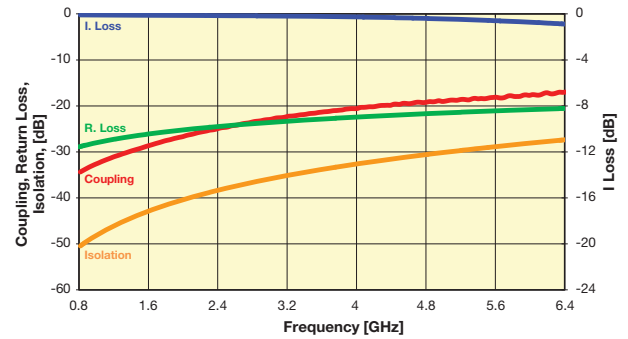

Coupler P/N CP603AxxxxHN

| Application | P/N Examples* | Frequency Band [MHz] | Coupling [dB] | I. Loss max. [dB] | Return Loss [dB] | Directivity [dB] |
|--------------|---------------|----------------------|---------------|-------------------|------------------|------------------|
| AMPS | CP0603A0836HN | 824 - 849 | 17.3 | 0.30 | 26 | 26 |
| | CP0603A0881HN | 869 - 894 | 17.0 | 0.30 | 25 | |
| GSM | CP0603A0902HN | 890 - 915 | 16.7 | 0.30 | 25 | |
| | CP0603A0947HN | 935 - 960 | 16.3 | 0.35 | 25 | |
| E-GSM | CP0603A0897HN | 880 - 915 | 17.0 | 0.35 | 25 | |
| | CP0603A0942HN | 925 - 960 | 16.3 | 0.35 | 25 | |
| PDC | CP0603A1441HN | 1429 - 1453 | 13.0 | 0.55 | 22 | |
| PCN | CP0603A1747HN | 1710 - 1785 | 11.4 | 0.75 | 20 | |
| | CP0603A1842HN | 1805 - 1880 | 11.0 | 0.75 | 20 | |
| PCS | CP0603A1880HN | 1850 - 1910 | 10.8 | 0.75 | 19 | |
| | CP0603A1960HN | 1930 - 1990 | 10.5 | 0.75 | 19 | |
| PHP | CP0603A1907HN | 1895 - 1920 | 10.7 | 0.75 | 19 | |
| DECT | CP0603A1890HN | 1880 - 1900 | 10.8 | 0.75 | 19 | |
| Wireless LAN | CP0603A2442HN | 2400 - 2484 | 8.8 | 1.00 | 17 | |
| WiFi | CP0603A3500HN | 3450 - 3550 | 5.9 | 1.48 | 25 | 21 |
| | CP0603A5000HN | 4950 - 5050 | 4.4 | 2.59 | 22 | 18 |
| | CP0603A5500HN | 5450 - 5550 | 4 | 2.95 | 22 | 17 |
| | CP0603A6000HN | 5950 - 6050 | 3.5 | 3.37 | 21 | 17 |

CP0603AxxxxHNTR

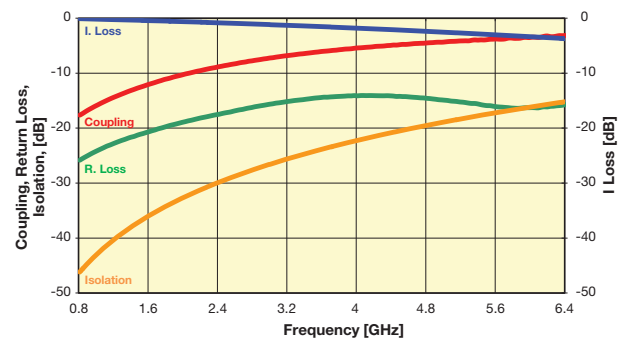

Coupler P/N CP603AxxxxMN

| Application | P/N Examples* | Frequency Band [MHz] | Coupling [dB] | I. Loss max. [dB] | Return Loss [dB] | Directivity [dB] |
|--------------|---------------|----------------------|---------------|-------------------|------------------|------------------|
| AMPS | CP0603A0836MN | 824 - 849 | 24.2 | 0.20 | 33 | 23 |
| | CP0603A0881MN | 869 - 894 | 23.8 | 0.20 | 32 | |
| GSM | CP0603A0902MN | 890 - 915 | 23.4 | 0.20 | 32 | |
| | CP0603A0947MN | 935 - 960 | 23.2 | 0.20 | 32 | |
| E-GSM | CP0603A0897MN | 880 - 915 | 23.4 | 0.20 | 32 | |
| | CP0603A0942MN | 925 - 960 | 23.2 | 0.20 | 32 | |
| PDC | CP0603A1441MN | 1429 - 1453 | 20.0 | 0.25 | 28 | |
| PCN | CP0603A1747MN | 1710 - 1785 | 18.4 | 0.25 | 27 | |
| | CP0603A1842MN | 1805 - 1880 | 18.0 | 0.25 | 26 | |
| PCS | CP0603A1880MN | 1850 - 1910 | 17.8 | 0.25 | 26 | |
| | CP0603A1960MN | 1930 - 1990 | 17.5 | 0.25 | 26 | |
| PHP | CP0603A1907MN | 1895 - 1920 | 17.7 | 0.25 | 26 | |
| DECT | CP0603A1890MN | 1880 - 1900 | 17.8 | 0.25 | 26 | |
| Wireless LAN | CP0603A2442MN | 2400 - 2484 | 15.6 | 0.35 | 24 | |
| WiFi | CP0603A3500MN | 3450 - 3550 | 12.8 | 0.58 | 18 | 20 |
| | CP0603A5000MN | 4950 - 5050 | 10.2 | 1.0 | 15 | 16 |
| | CP0603A5500MN | 5450 - 5550 | 9.7 | 1.2 | 15 | 14 |
| | CP0603A6000MN | 5950 - 6050 | 8.9 | 1.5 | 13.5 | 9 |

CP0603AxxxxMNTR

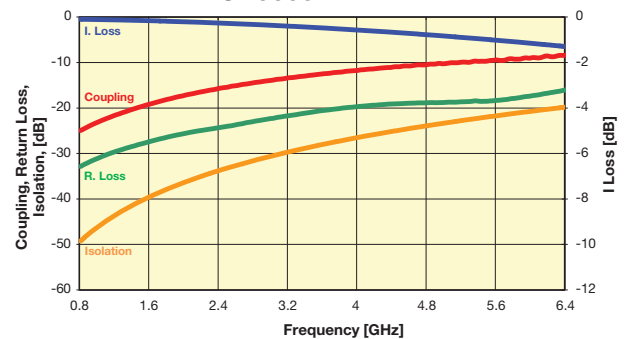

Important: Couplers can be used at any frequency within the indicated range.



Thin-Film Directional Couplers



CP0603 High Directivity LGA Type

Coupler P/N CP603AxxxxLN

| Application | P/N Examples* | Frequency Band [MHz] | Coupling [dB] | I. Loss max. [dB] | Return Loss [dB] | Directivity [dB] |
|--------------|---------------|----------------------|---------------|-------------------|------------------|------------------|
| AMPS | CP0603A0836LN | 824 - 849 | 26.89 | 0.08 | 32.5 | 18 |
| | CP0603A0881LN | 869 - 894 | 26.55 | 0.08 | 32.2 | |
| GSM | CP0603A0902LN | 890 - 915 | 26.2 | 0.09 | 31.9 | 18 |
| | CP0603A0947LN | 935 - 960 | 25.87 | 0.09 | 31.5 | |
| E-GSM | CP0603A0897LN | 880 - 915 | 26.2 | 0.09 | 31.9 | 18 |
| | CP0603A0942LN | 925 - 960 | 25.87 | 0.09 | 31.5 | |
| PDC | CP0603A1441LN | 1429 - 1453 | 22.31 | 0.12 | 28.1 | 17.5 |
| PCN | CP0603A1747LN | 1710 - 1785 | 20.51 | 0.15 | 26.4 | 16.5 |
| | CP0603A1842LN | 1805 - 1880 | 20.03 | 0.15 | 26 | |
| PCS | CP0603A1880LN | 1850 - 1910 | 19.87 | 0.16 | 26 | 16.5 |
| | CP0603A1960LN | 1930 - 1990 | 19.57 | 0.17 | 25.5 | |
| PHP | CP0603A1907LN | 1895 - 1920 | 19.77 | 0.16 | 25.7 | 16.5 |
| DECT | CP0603A1890LN | 1880 - 1900 | 19.87 | 0.16 | 25.8 | 16.5 |
| Wireless LAN | CP0603A2442LN | 2400 - 2484 | 17.7 | 0.22 | 23.9 | 16 |
| WiFi | CP0603A3500LN | 3450 - 3550 | 14.85 | 0.56 | 20.6 | 16 |
| | CP0603A5000LN | 4950 - 5050 | 12.4 | 0.95 | 17.8 | 11 |
| | CP0603A5500LN | 5450 - 5550 | 11.83 | 1.2 | 17.1 | 9 |
| | CP0603A6000LN | 5950 - 6050 | 11.08 | 1.33 | 15.9 | 9 |

CP0603AxxxxLNTR

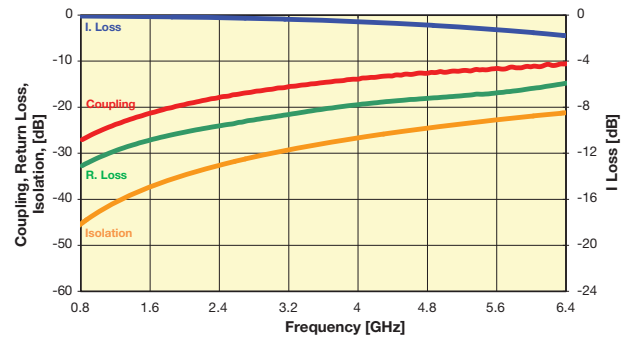

Coupler P/N CP603AxxxxKN

| Application | P/N Examples* | Frequency Band [MHz] | Coupling [dB] | I. Loss max. [dB] | Return Loss [dB] | Directivity [dB] |
|--------------|---------------|----------------------|---------------|-------------------|------------------|------------------|
| AMPS | CP0603A0836KN | 824 - 849 | 18.5 | 0.14 | 30 | 26 |
| | CP0603A0881KN | 869 - 894 | 18.1 | 0.14 | 29 | |
| GSM | CP0603A0902KN | 890 - 915 | 17.6 | 0.15 | 29 | 25 |
| | CP0603A0947KN | 935 - 960 | 17.3 | 0.15 | 29 | |
| E-GSM | CP0603A0897KN | 880 - 915 | 17.9 | 0.147 | 29 | 25 |
| | CP0603A0942KN | 925 - 960 | 17.6 | 0.15 | 29 | |
| PDC | CP0603A1441KN | 1429 - 1453 | 14 | 0.27 | 25 | 24 |
| PCN | CP0603A1747KN | 1710 - 1785 | 12.4 | 0.36 | 23 | 24 |
| | CP0603A1842KN | 1805 - 1880 | 12 | 0.39 | 22.5 | |
| PCS | CP0603A1880KN | 1850 - 1910 | 11.8 | 0.4 | 22 | 24 |
| | CP0603A1960KN | 1930 - 1990 | 11.4 | 0.44 | 22 | |
| PHP | CP0603A1907KN | 1895 - 1920 | 11.5 | 0.43 | 22 | 24 |
| DECT | CP0603A1890KN | 1880 - 1900 | 11.7 | 0.41 | 22 | 24 |
| Wireless LAN | CP0603A2442KN | 2400 - 2484 | 9.7 | 0.6 | 19 | 23 |
| WiFi | CP0603A3500KN | 3450 - 3550 | 7.2 | 1.15 | 15 | 19 |
| | CP0603A5000KN | 4950 - 5050 | 4.7 | 2.15 | 15 | 13 |
| | CP0603A5500KN | 5450 - 5550 | 4.2 | 2.5 | 17 | 13 |
| | CP0603A6000KN | 5950 - 6050 | 3.7 | 2.8 | 19 | 13 |

CP0603AxxxxKNTR

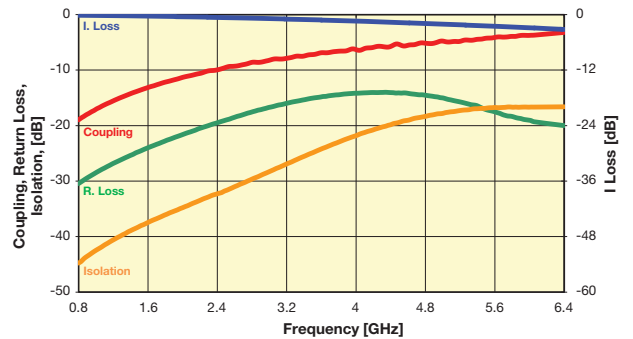

Important: Couplers can be used at any frequency within the indicated range.

Thin-Film Directional Couplers



CP0402 / CP0603 High Directivity Couplers Test Jigs

GENERAL DESCRIPTION

These jigs are designed for testing the CP0402 and CP0603 High Directivity Couplers using a Vector Network Analyzer.

They consist of a dielectric substrate, having 50Ω microstrips as conducting lines and a bottom ground plane located at a distance of 0.254mm (0.010") from the microstrips.

The substrate used is Neltec's NH9338ST0254C1BC.

The connectors are SMA type (female), 'Johnson Components Inc.' Product P/N: 142-0701-841.

Both a measurement jig and a calibration jig are provided.

The calibration jig is designed for a full 2-port calibration, and consists of an open line, short line and through line. LOAD calibration can be done by a 50Ω SMA termination.

MEASUREMENT PROCEDURE

When measuring a component, it can be either soldered or pressed using a non-metallic stick until all four ports touch the appropriate pads. Set the VNA to the relevant frequency band. Connect the VNA using a 10dB attenuator on the jig

terminal connected to port 2. Follow the VNA's instruction manual and use the [calibration jig](#) to perform a full 2-Port calibration in the required bandwidths.

Place the coupler on the [measurement jig](#) as follows:

Input (Coupler) → Connector 1 (Jig) Termination (Coupler) → Connector 3 (Jig)
Output (Coupler) → Connector 2 (Jig) Coupling (Coupler) → Connector 4 (Jig)

To measure I. Loss connect:

Connector 1 (Jig) → Port 1 (VNA) Connector 3 (Jig) → 50Ω
Connector 2 (Jig) → Port 2 (VNA) Connector 4 (Jig) → 50Ω

To measure R. Loss and Coupling connect:

Connector 1 (Jig) → Port 1 (VNA) Connector 3 (Jig) → 50Ω
Connector 2 (Jig) → 50Ω Connector 4 (Jig) → Port 2 (VNA)

To measure Isolation connect:

Connector 1 (Jig) → 50Ω Connector 3 (Jig) → 50Ω
Connector 2 (Jig) → Port 1 (VNA) Connector 4 (Jig) → Port 2 (VNA)

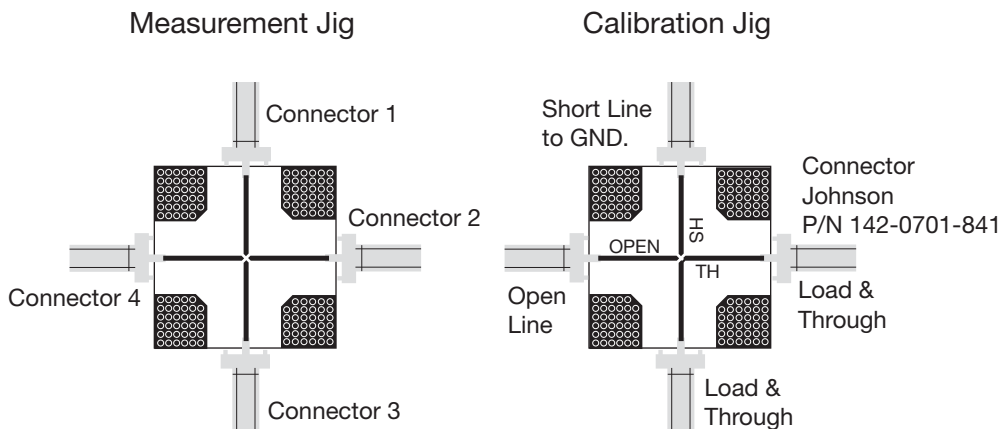

Thin-Film Directional Couplers



CP0603 SMD Type

GENERAL DESCRIPTION ITF (Integrated Thin-Film) TECHNOLOGY

The ITF SMD Coupler is based on thin-film multilayer technology. The technology provides a miniature part with excellent high frequency performance and rugged construction for reliable automatic assembly. The ITF Coupler is offered in a variety of frequency bands compatible with various types of high frequency wireless systems.

DIMENSIONS: millimeters (inches)

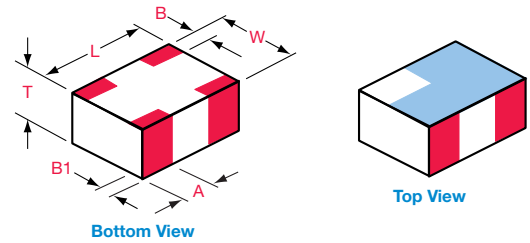

| | 0603 |
|----|-------------------------------------|
| L | 1.6±0.1 (0.063±0.004) |
| W | 0.84±0.1 (0.033±0.004) |
| T | 0.60±0.1 (0.028±0.004) |
| A | 0.35±0.15 (0.014±0.006) |
| B | 0.175±0.1 (0.007±0.004) |
| B1 | 0.00+0.1/0-0.0 (0.00+0.004/-0.0) |

APPLICATIONS

- Mobile Communications
- Satellite TV Receivers
- GPS
- Vehicle Location Systems
- Wireless LAN's

FEATURES

- Miniature Size: 0603
- Frequency Range: 800MHz - 3GHz
- Characteristic Impedance: 50Ω
- Operating / Storage Temp.: -40°C to +85°C
- Power Rating: 3W Continuous
- Low Profile
- Rugged Construction
- Taped and Reeled

HOW TO ORDER

| | | | | | | |
|---------------------|------------------|---------------|------------------|---------------|-------------------------------|--------------------|
| CP T | 0603 T | X T | **** T | X T | S T | TR T |
| Style | Size | Type | Frequency | Sub Type | Termination | Packaging Code |
| Directional Coupler | 0603 | | MHz | | Code | TR = Tape and Reel |
| | | | | | W = Sn90, Pb10 **S = Sn100 | |

**RoHS compliant

QUALITY INSPECTION

Finished parts are 100% tested for electrical parameters and visual characteristics. Each production lot is evaluated on a sample basis for:

- Static Humidity: 85°C, 85% RH, 160 hours
- Endurance: 125°C, I_R, 4 hours

TERMINATION

Nickel/Solder coating compatible with automatic soldering technologies: reflow, wave soldering, vapor phase and manual.

Recommended Pad Layout Dimensions mm (inches)

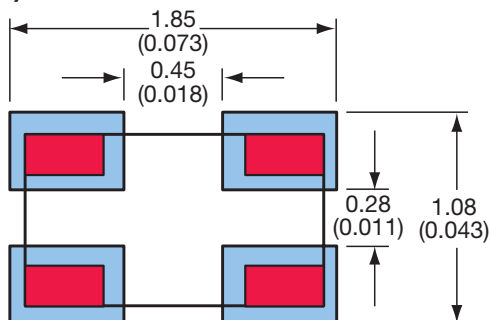

TERMINALS (Top View)

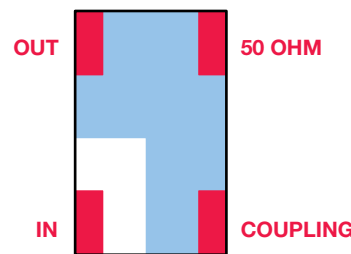

Not RoHS Compliant



For RoHS compliant products, please select correct termination style.

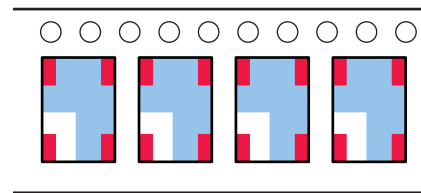

Orientation in tape

Thin-Film Directional Couplers



CP0603 SMD Type

Coupler P/N CP0603A****AS

| Application | P/N Examples | Frequency Band [MHz] | Coupling [dB] | I. Loss max | VSWR max |
|--------------|---------------|----------------------|---------------|-------------|----------|
| AMPS | CP0603A0836AS | 824 - 849 | 18.5±1 | 0.25 | 1.2 |
| | CP0603A0881AS | 869 - 894 | 18.5±1 | | |
| GSM | CP0603A0902AS | 890 - 915 | 18±1 | 0.25 | |
| | CP0603A0947AS | 935 - 960 | 17.5±1 | | |
| E-GSM | CP0603A0897AS | 880 - 915 | 18±1 | 0.4 | |
| | CP0603A0942AS | 925 - 960 | 17.5±1 | | |
| PDC | CP0603A1441AS | 1429 - 1453 | 14±1 | 0.4 | |
| PCN | CP0603A1747AS | 1710 - 1785 | 12.5±1 | 0.6 | |
| | CP0603A1842AS | 1805 - 1880 | 12±1 | | |
| PCS | CP0603A1880AS | 1850 - 1910 | 12±1 | 0.65 | |
| | CP0603A1960AS | 1930 - 1990 | 11.5±1 | | |
| PHP | CP0603A1907AS | 1895 - 1920 | 12±1 | 0.6 | |
| DECT | CP0603A1890AS | 1880 - 1900 | 12±1 | 0.6 | |
| Wireless LAN | CP0603A2442AS | 2400 - 2484 | 10±1 | 0.85 | |

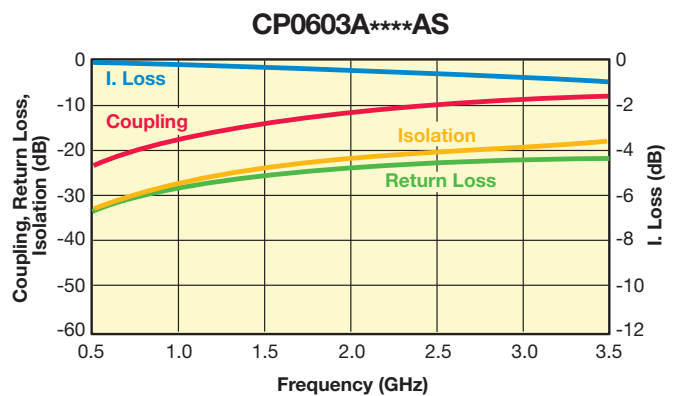

Coupler P/N CP0603A****BS

| Application | P/N Examples | Frequency Band [MHz] | Coupling [dB] | I. Loss max | VSWR max |
|--------------|---------------|----------------------|---------------|-------------|----------|
| AMPS | CP0603A0836BS | 824 - 849 | 16±1 | 0.25 | 1.2 |
| | CP0603A0881BS | 869 - 894 | 15.5±1 | | |
| GSM | CP0603A0902BS | 890 - 915 | 15.5±1 | 0.55 | |
| | CP0603A0947BS | 935 - 960 | 15±1 | | |
| E-GSM | CP0603A0897BS | 880 - 915 | 15.5±1 | 0.8 | |
| | CP0603A0942BS | 925 - 960 | 15±1 | | |
| PDC | CP0603A1441BS | 1429 - 1453 | 11.5±1 | 0.55 | |
| PCN | CP0603A1747BS | 1710 - 1785 | 10±1 | 1.3 | |
| | CP0603A1842BS | 1805 - 1880 | 9.5±1 | | |
| PCS | CP0603A1880BS | 1850 - 1910 | 9±1 | 1.4 | |
| | CP0603A1960BS | 1930 - 1990 | 9±1 | | |
| PHP | CP0603A1907BS | 1895 - 1920 | 9±1 | 1.4 | |
| DECT | CP0603A1890BS | 1880 - 1900 | 9±1 | 1.4 | |
| Wireless LAN | CP0603A2442BS | 2400 - 2484 | 7.5±1 | 1.1 | |

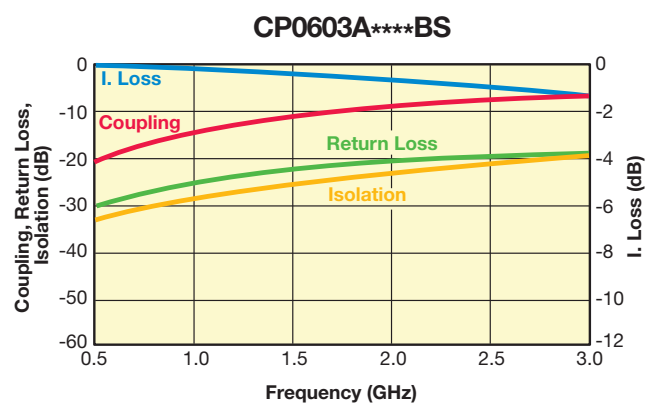

Coupler P/N CP0603A****CS

| Application | P/N Examples | Frequency Band [MHz] | Coupling [dB] | I. Loss max | VSWR max |
|--------------|---------------|----------------------|---------------|-------------|----------|
| AMPS | CP0603A0836CS | 824 - 849 | 21±1 | 0.25 | 1.2 |
| | CP0603A0881CS | 869 - 894 | 20.5±1 | | |
| GSM | CP0603A0902CS | 890 - 915 | 20.5±1 | 0.40 | |
| | CP0603A0947CS | 935 - 960 | 20±1 | | |
| E-GSM | CP0603A0897CS | 880 - 915 | 20.5±1 | 0.5 | |
| | CP0603A0942CS | 925 - 960 | 20±1 | | |
| PDC | CP0603A1441CS | 1429 - 1453 | 16.5±1 | 0.40 | |
| PCN | CP0603A1747CS | 1710 - 1785 | 15±1 | 0.65 | |
| | CP0603A1842CS | 1805 - 1880 | 14.5±1 | | |
| PCS | CP0603A1880CS | 1850 - 1910 | 14.5±1 | 1.0 | |
| | CP0603A1960CS | 1930 - 1990 | 14±1 | | |
| PHP | CP0603A1907CS | 1895 - 1920 | 14.5±1 | 1.0 | |
| DECT | CP0603A1890CS | 1880 - 1900 | 14.5±1 | 1.0 | |
| Wireless LAN | CP0603A2442CS | 2400 - 2484 | 12.5±1 | 0.65 | |

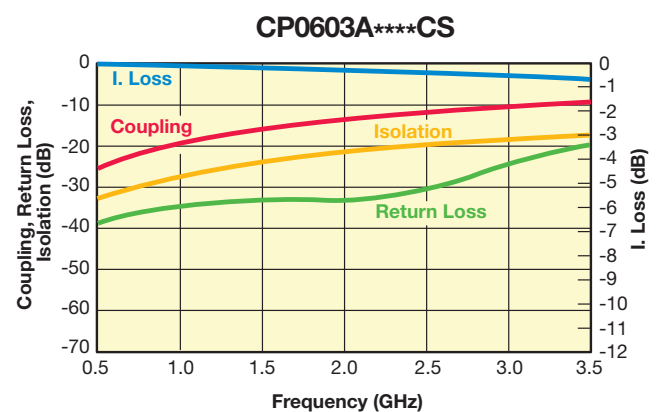

Coupler P/N CP0603A****DS

| Application | P/N Examples | Frequency Band [MHz] | Coupling [dB] | I. Loss max | VSWR max |
|--------------|---------------|----------------------|---------------|-------------|----------|
| AMPS | CP0603A0836DS | 824 - 849 | 15.0±1 | 0.40 | 1.2 |
| | CP0603A0881DS | 869 - 894 | 14.5±1 | | |
| GSM | CP0603A0902DS | 890 - 915 | 14.5±1 | 0.7 | |
| | CP0603A0947DS | 935 - 960 | 14±1 | | |
| E-GSM | CP0603A0897DS | 880 - 915 | 14.5±1 | 0.9 | |
| | CP0603A0942DS | 925 - 960 | 14±1 | | |
| PDC | CP0603A1441DS | 1429 - 1453 | 10.5±1 | 0.7 | |
| PCN | CP0603A1747DS | 1710 - 1785 | 9±1 | 1.0 | |
| | CP0603A1842DS | 1805 - 1880 | 8.5±1 | | |
| PCS | CP0603A1880DS | 1850 - 1910 | 8.5±1 | 1.5 | |
| | CP0603A1960DS | 1930 - 1990 | 8±1 | | |
| PHP | CP0603A1907DS | 1895 - 1920 | 8.5±1 | 1.5 | |
| DECT | CP0603A1890DS | 1880 - 1900 | 8.5±1 | 1.5 | |
| Wireless LAN | CP0603A2442DS | 2400 - 2484 | 6.5±1 | 1.5 | |

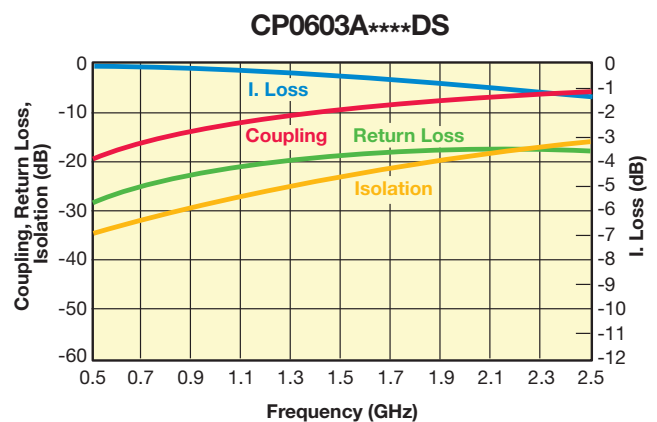

Important: Couplers can be used at any frequency within the indicated range.



Thin-Film Directional Couplers



CP0603 SMD Type

Coupler P/N CP0603B****AS

| Application | P/N Examples | Frequency Band [MHz] | Coupling [dB] | I. Loss max | VSWR max | |
|--------------|---------------|----------------------|---------------|-------------|----------|------|
| AMPS | CP0603B0836AS | 824 - 849 | 24.5±1 | 0.2 | 1.2 | |
| | CP0603B0881AS | 869 - 894 | 24±1 | | | |
| GSM | CP0603B0902AS | 890 - 915 | 24±1 | | | |
| | CP0603B0947AS | 935 - 960 | 23.5±1 | | | |
| E-GSM | CP0603B0897AS | 880 - 915 | 24±1 | | | |
| | CP0603B0942AS | 925 - 960 | 23.5±1 | | | |
| PDC | CP0603B1441AS | 1429 - 1453 | 20±1 | | | 0.25 |
| PCN | CP0603B1747AS | 1710 - 1785 | 18±1 | | | |
| PCS | CP0603B1842AS | 1805 - 1880 | 17.5±1 | | | 0.3 |
| | CP0603B1880AS | 1850 - 1910 | 17.5±1 | | | |
| PHP | CP0603B1960AS | 1930 - 1990 | 17.5±1 | | | |
| DECT | CP0603B1907AS | 1895 - 1920 | 17.5±1 | | | |
| Wireless LAN | CP0603B1890AS | 1880 - 1900 | 17.5±1 | 0.45 | | |
| | CP0603B2442AS | 2400 - 2484 | 15.5±1 | | | |

CP0603B****AS

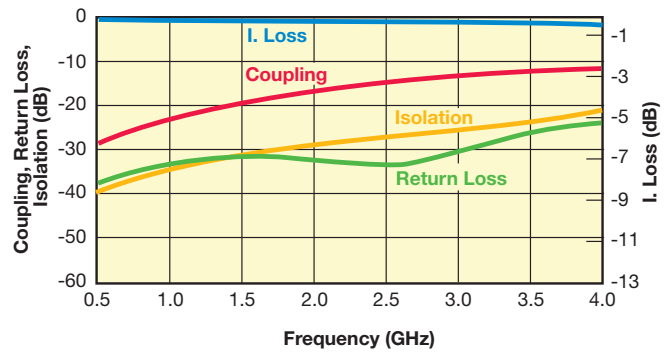

Coupler P/N CP0603B****BS

| Application | P/N Examples | Frequency Band [MHz] | Coupling [dB] | I. Loss max | VSWR max | |
|--------------|---------------|----------------------|---------------|-------------|----------|------|
| AMPS | CP0603B0836BS | 824 - 849 | 25.5±1 | 0.2 | 1.2 | |
| | CP0603B0881BS | 869 - 894 | 25±1 | | | |
| GSM | CP0603B0902BS | 890 - 915 | 25±1 | | | |
| | CP0603B0947BS | 935 - 960 | 24.5±1 | | | |
| E-GSM | CP0603B0897BS | 880 - 915 | 25±1 | | | |
| | CP0603B0942BS | 925 - 960 | 24.5±1 | | | |
| PDC | CP0603B1441BS | 1429 - 1453 | 21±1 | | | 0.25 |
| PCN | CP0603B1747BS | 1710 - 1785 | 19±1 | | | |
| PCS | CP0603B1842BS | 1805 - 1880 | 19±1 | | | 0.25 |
| | CP0603B1880BS | 1850 - 1910 | 18.5±1 | | | |
| PHP | CP0603B1960BS | 1930 - 1990 | 18.5±1 | | | |
| DECT | CP0603B1907BS | 1895 - 1920 | 18.5±1 | | | |
| Wireless LAN | CP0603B1890BS | 1880 - 1900 | 18.5±1 | 0.35 | | |
| | CP0603B2442BS | 2400 - 2484 | 16.5±1 | | | |

CP0603B****BS

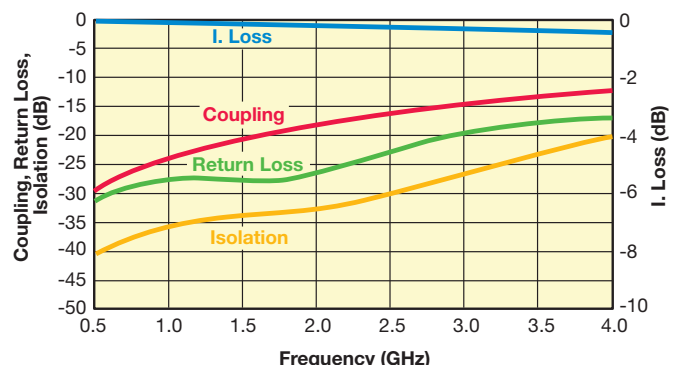

Coupler P/N CP0603B****CS

| Application | P/N Examples | Frequency Band [MHz] | Coupling [dB] | I. Loss max | VSWR max | |
|--------------|---------------|----------------------|---------------|-------------|----------|------|
| AMPS | CP0603B0836CS | 824 - 849 | 26.5±1 | 0.2 | 1.2 | |
| | CP0603B0881CS | 869 - 894 | 26±1 | | | |
| GSM | CP0603B0902CS | 890 - 915 | 26±1 | | | |
| | CP0603B0947CS | 935 - 960 | 25.5±1 | | | |
| E-GSM | CP0603B0897CS | 880 - 915 | 26±1 | | | |
| | CP0603B0942CS | 925 - 960 | 25.5±1 | | | |
| PDC | CP0603B1441CS | 1429 - 1453 | 22±1 | | | 0.25 |
| PCN | CP0603B1747CS | 1710 - 1785 | 20.5±1 | | | |
| PCS | CP0603B1842CS | 1805 - 1880 | 20±1 | | | 0.25 |
| | CP0603B1880CS | 1850 - 1910 | 20±1 | | | |
| PHP | CP0603B1960CS | 1930 - 1990 | 19.5±1 | | | |
| DECT | CP0603B1907CS | 1895 - 1920 | 20±1 | | | |
| Wireless LAN | CP0603B1890CS | 1880 - 1900 | 20±1 | 0.35 | | |
| | CP0603B2442CS | 2400 - 2484 | 18±1 | | | |

CP0603B****CS

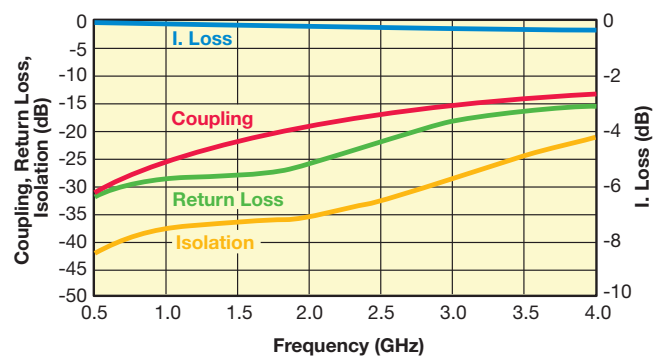

Important: Couplers can be used at any frequency within the indicated range.

Thin-Film Directional Couplers



CP0603 SMD Type – High Directivity

Coupler P/N CP0603D****AS

| Application | P/N Examples | Frequency Band [MHz] | Coupling [dB] | I. Loss max. [dB] | Return Loss [dB] | Directivity [dB] |
|--------------|---------------|----------------------|---------------|-------------------|------------------|------------------|
| AMPS | CP0603D0836AS | 824 - 849 | 13.50 | 0.50 | 23 | 21 |
| | CP0603D0881AS | 869 - 894 | 13.00 | | | |
| GSM | CP0603D0902AS | 890 - 915 | 12.50 | 13.00 | 22 | 21 |
| | CP0603D0947AS | 935 - 960 | | | | |
| E-GSM | CP0603D0897AS | 880 - 915 | 12.50 | 1.00 | 18 | 19 |
| | CP0603D0942AS | 925 - 960 | | | | |
| PDC | CP0603D1441AS | 1429 - 1453 | 9.00 | 8.00 | 17 | 18 |
| PCN | CP0603D1747AS | 1710 - 1785 | 7.50 | 1.40 | 17 | 17 |
| | CP0603D1842AS | 1805 - 1880 | | | | |
| PCS | CP0603D1880AS | 1850 - 1910 | 7.00 | 1.40 | 16 | 17 |
| | CP0603D1960AS | 1930 - 1990 | | | | |
| PHP | CP0603D1907AS | 1895 - 1920 | 7.00 | 2.00 | 15 | 15 |
| DECT | CP0603D1890AS | 1880 - 1900 | 7.00 | 2.00 | 15 | 15 |
| Wireless LAN | CP0603D2442AS | 2400 - 2484 | 5.50 | 2.00 | 15 | 15 |

CP0603D****AS

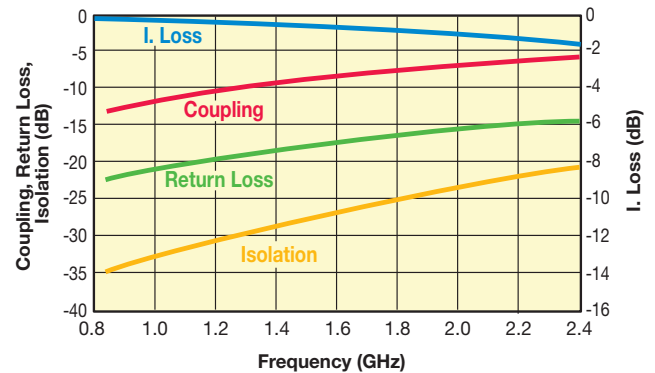

Coupler P/N CP0603D****BS

| Application | P/N Examples | Frequency Band [MHz] | Coupling [dB] | I. Loss max. [dB] | Return Loss [dB] | Directivity [dB] |
|--------------|---------------|----------------------|---------------|-------------------|------------------|------------------|
| AMPS | CP0603D0836BS | 824 - 849 | 20.00 | 0.25 | 36 | 19 |
| | CP0603D0881BS | 869 - 894 | 19.50 | | | |
| GSM | CP0603D0902BS | 890 - 915 | 19.00 | 0.40 | 35 | 19 |
| | CP0603D0947BS | 935 - 960 | | | | |
| E-GSM | CP0603D0897BS | 880 - 915 | 19.00 | 0.50 | 36 | 19 |
| | CP0603D0942BS | 925 - 960 | | | | |
| PDC | CP0603D1441BS | 1429 - 1453 | 15.50 | 30 | 28 | 28 |
| PCN | CP0603D1747BS | 1710 - 1785 | 14.00 | 0.55 | 27 | 27 |
| | CP0603D1842BS | 1805 - 1880 | | | | |
| PCS | CP0603D1880BS | 1850 - 1910 | 13.50 | 0.55 | 27 | 27 |
| | CP0603D1960BS | 1930 - 1990 | | | | |
| PHP | CP0603D1907BS | 1895 - 1920 | 13.00 | 0.70 | 24 | 24 |
| DECT | CP0603D1890BS | 1880 - 1900 | 13.00 | 0.70 | 24 | 24 |
| Wireless LAN | CP0603D2442BS | 2400 - 2484 | 11.00 | 0.70 | 24 | 24 |

CP0603D****BS

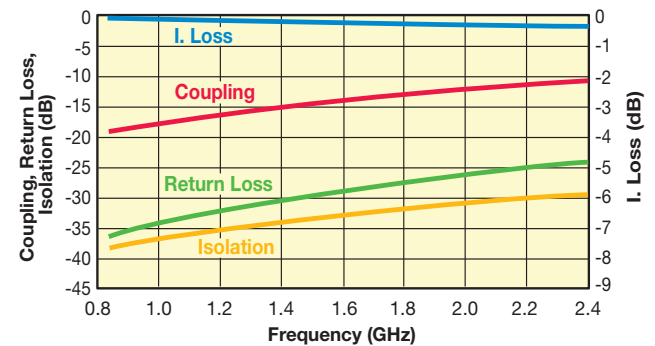

Important: Couplers can be used at any frequency within the indicated range.



Thin-Film Directional Couplers



CP0805 SMD Type

GENERAL DESCRIPTION ITF (Integrated Thin-Film) TECHNOLOGY

The ITF SMD Coupler is based on thin-film multilayer technology. The technology provides a miniature part with excellent high frequency performance and rugged construction for reliable automatic assembly.

The ITF Coupler is offered in a variety of frequency bands compatible with various types of high frequency wireless systems.

FEATURES

- Small Size: 0805
- Frequency Range: 800MHz - 3GHz
- Characteristic Impedance: 50Ω
- Operating / Storage Temp.: -40°C to +85°C
- Power Rating: 3W Continuous
- Low Profile
- Rugged Construction
- Taped and Reeled

APPLICATIONS

- Mobile Communications
- Satellite TV Receivers
- GPS
- Vehicle Location Systems
- Wireless LAN's

DIMENSIONS: (Top View) millimeters (inches)



| | 0805 |
|---|-------------------------|
| L | 2.03±0.1 (0.080±0.004) |
| W | 1.55±0.1 (0.061±0.004) |
| T | 0.98±0.1 (0.039±0.004) |
| A | 0.56±0.25 (0.022±0.010) |
| B | 0.35±0.15 (0.014±0.006) |

HOW TO ORDER

CP
T
Style
Directional Coupler

0805
T
Size
0805

A
T
Layout Type
(see layout types)

0902
T
Frequency
MHz

A
T
Sub Type
(see layout sub-types)

S
T
Termination Code
W = Nickel/Solder (Sn/Pb)
**S = Nickel / Lead Free Solder (Sn100)

TR
T
Packaging Code
TR = Tape and Reel

Not RoHS Compliant



For RoHS compliant products, please select correct termination style.

****RoHS compliant**

QUALITY INSPECTION

Finished parts are 100% tested for electrical parameters and visual characteristics. Each production lot is evaluated on a sample basis for:

- Static Humidity: 85°C, 85% RH, 160 hours
- Endurance: 125°C, I_R, 4 hours

TERMINATION

Nickel/Solder coating (Sn, Pb) compatible with automatic soldering technologies: reflow, wave soldering, vapor phase and manual.

Recommended Pad Layout Dimensions mm (inches)

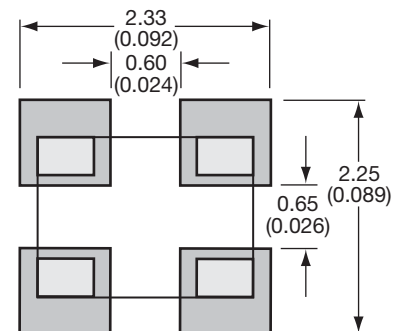

NOTE: Components must be mounted on the board with the white (Alumina) side DOWN.

Thin-Film Directional Couplers



CP0805 Layout Types

LAYOUT



Sn100 LAYOUT



Type: A
Sub-Type: A

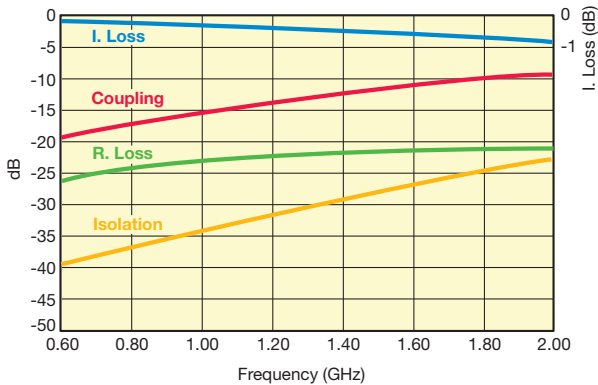

LAYOUT



Sn100 LAYOUT



Type: A
Sub-Type: B



| Application | P/N Examples | Frequency Band [MHz] | Coupling [dB] | I. Loss max | VSWR max |
|-------------|---------------|----------------------|---------------|-------------|----------|
| AMPS | CP0805A0836AW | 824 - 849 | 16.5±1 | 0.25 | 1.2 |
| | CP0805A0881AW | 869 - 894 | 16±1 | | |
| GSM | CP0805A0902AW | 890 - 915 | 16±1 | 0.5 | 1.3 |
| | CP0805A0947AW | 935 - 960 | 15.5±1 | | |
| E-GSM | CP0805A0897AW | 880 - 915 | 16±1 | 0.7 | 1.4 |
| | CP0805A0942AW | 925 - 960 | 15.5±1 | | |
| PDC | CP0805A1441AW | 1429 - 1453 | 12±1 | 0.5 | 1.3 |
| PCN | CP0805A1747AW | 1710 - 1785 | 10.5±1 | 0.8 | 1.4 |
| | CP0805A1842AW | 1805 - 1880 | 10±1 | | |
| PCS | CP0805A1880AW | 1850 - 1910 | 9.5±1 | 0.6 | 1.4 |
| | CP0805A1960AW | 1930 - 1990 | 9.5±1 | | |
| PHP | CP0805A1907AW | 1895 - 1920 | 9.5±1 | 0.6 | 1.4 |
| DECT | CP0805A1890AW | 1880 - 1900 | 9.5±1 | 0.6 | 1.4 |

| Application | P/N Examples | Frequency Band [MHz] | Coupling [dB] | I. Loss max | VSWR max |
|--------------|---------------|----------------------|---------------|-------------|----------|
| AMPS | CP0805A0836BW | 824 - 849 | 19±1 | 0.25 | 1.2 |
| | CP0805A0881BW | 869 - 894 | 18.5±1 | | |
| GSM | CP0805A0902BW | 890 - 915 | 18±1 | 0.35 | 1.4 |
| | CP0805A0947BW | 935 - 960 | 18±1 | | |
| E-GSM | CP0805A0897BW | 880 - 915 | 18.5±1 | 0.5 | 1.4 |
| | CP0805A0942BW | 925 - 960 | 18±1 | | |
| PCN | CP0805A1747BW | 1710 - 1785 | 12.5±1 | 0.5 | 1.4 |
| PCS | CP0805A1842BW | 1805 - 1880 | 12.5±1 | 0.6 | 1.4 |
| | CP0805A1880BW | 1850 - 1910 | 12±1 | | |
| PHP | CP0805A1960BW | 1930 - 1990 | 11.5±1 | 0.7 | 1.4 |
| DECT | CP0805A1907BW | 1895 - 1920 | 12±1 | 0.6 | 1.4 |
| Wireless LAN | CP0805A1890BW | 1880 - 1900 | 12±1 | 0.6 | 1.4 |
| Wireless LAN | CP0805A2442BW | 2400 - 2484 | 10±1 | 0.9 | 1.4 |

LAYOUT



Sn100 LAYOUT

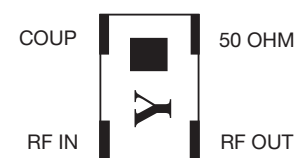

Type: A
Sub-Type: C



| Application | P/N Examples | Frequency Band [MHz] | Coupling [dB] | I. Loss max | VSWR max |
|--------------|---------------|----------------------|---------------|-------------|----------|
| AMPS | CP0805A0836CW | 824 - 849 | 14±1 | 0.5 | 1.4 |
| | CP0805A0881CW | 869 - 894 | 13.5±1 | | |
| GSM | CP0805A0902CW | 890 - 915 | 13.5±1 | 1.15 | 1.8 |
| | CP0805A0947CW | 935 - 960 | 13±1 | | |
| E-GSM | CP0805A0897CW | 880 - 915 | 13.5±1 | 1.6 | 2.2 |
| | CP0805A0942CW | 925 - 960 | 13±1 | | |
| PDC | CP0805A1441CW | 1429 - 1453 | 9.5±1 | 1.15 | 1.8 |
| PCN | CP0805A1747CW | 1710 - 1785 | 8±1 | 1.75 | 2.2 |
| | CP0805A1842CW | 1805 - 1880 | 8±1 | | |
| PCS | CP0805A1880CW | 1850 - 1910 | 7.5±1 | 2.5 | 2.2 |
| | CP0805A1960CW | 1930 - 1990 | 7.5±1 | | |
| PHP | CP0805A1907CW | 1895 - 1920 | 7.5±1 | 2.5 | 2.2 |
| DECT | CP0805A1890CW | 1880 - 1900 | 7.5±1 | 2.5 | 2.2 |
| Wireless LAN | CP0805A2442CW | 2400 - 2484 | 6±1 | 2.5 | 2.2 |

Important: Couplers can be used at any frequency within the indicated range.



Thin-Film Directional Couplers



CP0805 Layout Types

LAYOUT



Sn100 LAYOUT



Type: A
Sub-Type: D



| Application | P/N Examples | Frequency Band [MHz] | Coupling [dB] | I. Loss max | VSWR max |
|--------------|---------------|----------------------|---------------|-------------|----------|
| AMPS | CP0805A0836DW | 824 - 849 | 13.0±1 | 0.5 | 1.4 |
| | CP0805A0881DW | 869 - 894 | 12.5±1 | | |
| GSM | CP0805A0902DW | 890 - 915 | 12.5±1 | 1.85 | 1.8 |
| | CP0805A0947DW | 935 - 960 | 12±1 | | |
| E-GSM | CP0805A0897DW | 880 - 915 | 12.5±1 | 2.15 | 2.1 |
| | CP0805A0942DW | 925 - 960 | 12±1 | | |
| PDC | CP0805A1441DW | 1429 - 1453 | 8.5±1 | 1.25 | 1.8 |
| PCN | CP0805A1747DW | 1710 - 1785 | 7±1 | 1.85 | 2.2 |
| | CP0805A1842DW | 1805 - 1880 | 7±1 | | |
| PCS | CP0805A1880DW | 1850 - 1910 | 7±1 | 2.4 | 2.4 |
| | CP0805A1960DW | 1930 - 1990 | 6.5±1 | | |
| PHP | CP0805A1907DW | 1895 - 1920 | 6.5±1 | 1.85 | 1.8 |
| DECT | CP0805A1890DW | 1880 - 1900 | 7±1 | 2.4 | 2.1 |
| Wireless LAN | CP0805A2442DW | 2400 - 2484 | 5.5±1 | 2.4 | 2.1 |

LAYOUT



Sn100 LAYOUT

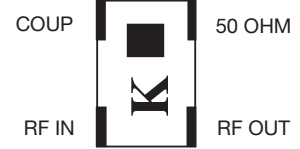

Type: A
Sub-Type: E



| Application | P/N Examples | Frequency Band [MHz] | Coupling [dB] | I. Loss max | VSWR max |
|--------------|---------------|----------------------|---------------|-------------|----------|
| AMPS | CP0805A0836EW | 824 - 849 | 11±1 | 0.85 | 1.4 |
| | CP0805A0881EW | 869 - 894 | 10.5±1 | | |
| GSM | CP0805A0902EW | 890 - 915 | 10.5±1 | 1.8 | 1.8 |
| | CP0805A0947EW | 935 - 960 | 10±1 | | |
| E-GSM | CP0805A0897EW | 880 - 915 | 10.5±1 | 2.7 | 2.2 |
| | CP0805A0942EW | 925 - 960 | 10±1 | | |
| PDC | CP0805A1441EW | 1429 - 1453 | 7±1 | 1.8 | 1.8 |
| PCN | CP0805A1747EW | 1710 - 1785 | 5.5±1 | 3.15 | 2.4 |
| | CP0805A1842EW | 1805 - 1880 | 5.5±1 | | |
| PCS | CP0805A1880EW | 1850 - 1910 | 5±1 | 4.2 | 2.4 |
| | CP0805A1960EW | 1930 - 1990 | 5±1 | | |
| PHP | CP0805A1907EW | 1895 - 1920 | 5±1 | 2.7 | 2.2 |
| DECT | CP0805A1890EW | 1880 - 1900 | 5±1 | 4.2 | 2.4 |
| Wireless LAN | CP0805A2442EW | 2400 - 2484 | 4±1 | 4.2 | 2.4 |

Type: B
Sub-Type: A

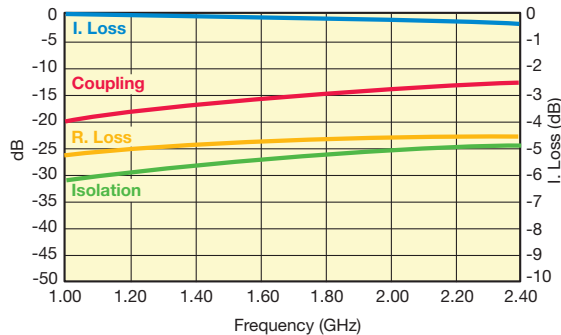

LAYOUT

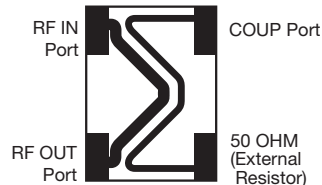

Sn100 LAYOUT

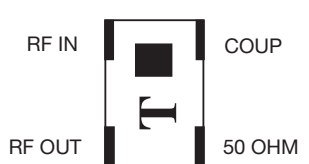

| Application | P/N Examples | Frequency Band [MHz] | Coupling [dB] | I. Loss max | VSWR max |
|--------------|---------------|----------------------|---------------|-------------|----------|
| AMPS | CP0805B0836AW | 824 - 849 | 21.5±1 | 0.25 | 1.2 |
| | CP0805B0881AW | 869 - 894 | 21±1 | | |
| GSM | CP0805B0902AW | 890 - 915 | 21±1 | 0.3 | 1.2 |
| | CP0805B0947AW | 935 - 960 | 20.5±1 | | |
| E-GSM | CP0805B0897AW | 880 - 915 | 21±1 | 0.4 | 1.2 |
| | CP0805B0942AW | 925 - 960 | 20.5±1 | | |
| PDC | CP0805B1441AW | 1429 - 1453 | 17±1 | 0.3 | 1.2 |
| PCN | CP0805B1747AW | 1710 - 1785 | 15.5±1 | 0.4 | 1.2 |
| | CP0805B1842AW | 1805 - 1880 | 15.5±1 | | |
| PCS | CP0805B1880AW | 1850 - 1910 | 15±1 | 0.3 | 1.2 |
| | CP0805B1960AW | 1930 - 1990 | 14.5±1 | | |
| PHP | CP0805B1907AW | 1895 - 1920 | 15±1 | 0.3 | 1.2 |
| DECT | CP0805B1890AW | 1880 - 1900 | 15±1 | 0.4 | 1.2 |
| Wireless LAN | CP0805B2442AW | 2400 - 2484 | 13±1 | 0.4 | 1.2 |

Important: Couplers can be used at any frequency within the indicated range.

Thin-Film Directional Couplers



CP0805 Layout Types



Type: B
Sub-Type: B



Type: B
Sub-Type: C



| Application | P/N Examples | Frequency Band [MHz] | Coupling [dB] | I. Loss max | VSWR max |
|--------------|---------------|----------------------|---------------|-------------|----------|
| AMPS | CP0805B0836BW | 824 - 849 | 23.5±1 | 0.25 | 1.2 |
| | CP0805B0881BW | 869 - 894 | 23±1 | | |
| GSM | CP0805B0902BW | 890 - 915 | 22.5±1 | | |
| | CP0805B0947BW | 935 - 960 | 22±1 | | |
| E-GSM | CP0805B0897BW | 880 - 915 | 23±1 | | |
| | CP0805B0942BW | 925 - 960 | 22±1 | | |
| PDC | CP0805B1441BW | 1429 - 1453 | 18.5±1 | | |
| PCN | CP0805B1747BW | 1710 - 1785 | 17±1 | | |
| | CP0805B1842BW | 1805 - 1880 | 16.5±1 | | |
| PCS | CP0805B1880BW | 1850 - 1910 | 16.5±1 | | |
| | CP0805B1960BW | 1930 - 1990 | 16±1 | | |
| PHP | CP0805B1907BW | 1895 - 1920 | 16±1 | | |
| DECT | CP0805B1890BW | 1880 - 1900 | 16±1 | | |
| Wireless LAN | CP0805B2442BW | 2400 - 2484 | 14±1 | 0.4 | |

| Application | P/N Examples | Frequency Band [MHz] | Coupling [dB] | I. Loss max | VSWR max |
|--------------|---------------|----------------------|---------------|-------------|----------|
| AMPS | CP0805B0836CW | 824 - 849 | 25±1 | 0.25 | 1.2 |
| | CP0805B0881CW | 869 - 894 | 24.5±1 | | |
| GSM | CP0805B0902CW | 890 - 915 | 24±1 | | |
| | CP0805B0947CW | 935 - 960 | 24±1 | | |
| E-GSM | CP0805B0897CW | 880 - 915 | 24.5±1 | | |
| | CP0805B0942CW | 925 - 960 | 24±1 | | |
| PDC | CP0805B1441CW | 1429 - 1453 | 20±1 | | |
| PCN | CP0805B1747CW | 1710 - 1785 | 18.5±1 | | |
| | CP0805B1842CW | 1805 - 1880 | 18.5±1 | | |
| PCS | CP0805B1880CW | 1850 - 1910 | 18±1 | | |
| | CP0805B1960CW | 1930 - 1990 | 17.5±1 | | |
| PHP | CP0805B1907CW | 1895 - 1920 | 18±1 | | |
| DECT | CP0805B1890CW | 1880 - 1900 | 18±1 | | |
| Wireless LAN | CP0805B2442CW | 2400 - 2484 | 16±1 | 0.4 | |

Important: Couplers can be used at any frequency within the indicated range.



Thin-Film Directional Couplers



CP0805 Layout Types

VHF DIRECTIONAL COUPLER

CP0805L0155ASTR

Sn100 LAYOUT



| P/N | Frequency [MHz] | Coupling [dB] | R. Loss [dB] | I. Loss max [dB] | Directivity [dB] |
|-----------------|-----------------|---------------|--------------|------------------|------------------|
| CP0805L0155ASTR | 155 | 17.1±1 | 24 | 0.35 | 22 |



UHF DIRECTIONAL COUPLER

CP0805L0436BSTR

Sn100 LAYOUT



| P/N | Frequency [MHz] | Coupling [dB] | R. Loss [dB] | I. Loss max [dB] | Directivity [dB] |
|-----------------|-----------------|---------------|--------------|------------------|------------------|
| CP0805L0436BSTR | 403-470 | 15.85±1 | 35 | 0.25 | 22 |



3

Important: Couplers can be used at any frequency within the indicated range.

Thin-Film Directional Couplers



CP0805 and CP0603 Test Jig

ITF TEST JIG FOR COUPLER TYPES 0805 AND 0603 SMD

GENERAL DESCRIPTION

This jig is designed for the testing of CP0805 and CP0603 series Directional Couplers using a vector network analyzer. It consists of a FR4 multi-layer substrate, having 50Ω microstrips as conducting lines and a ground plane in the middle layer, located at a distance of 0.2mm from the microstrips.

The connectors are SMA type (female), 'Johnson Components Inc.' Product P/N: 142-0701-881.

The jig is designed for a full 2-port calibration. LOAD calibration can be done either by a 50Ω SMA termination, or by soldering a 50Ω chip resistor at the 50Ω ports.

MEASUREMENT PROCEDURE

When measuring a component, it can be either soldered or pressed by a non-metallic stick until all four ports touch the appropriate pads. To measure the coupling (and the R. Loss) place the component on the Port 1 & Port 2 pads. Use two SMA 50Ω terminations (male) to terminate the ports, which are not connected to the network analyzer, and connect the network analyzer to the two ports. A 90° rotation of the component on its pads allows measuring a second parameter (I. Loss).

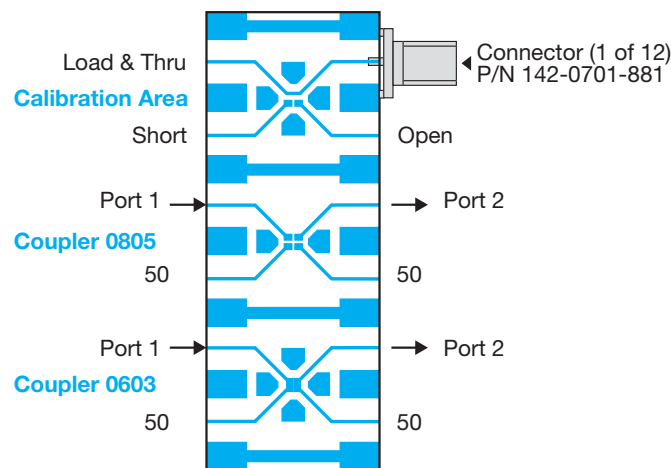

CP0805 SERIES DIRECTIONAL COUPLERS

Orientation and Tape and Reel Packaging Specification (Top View)

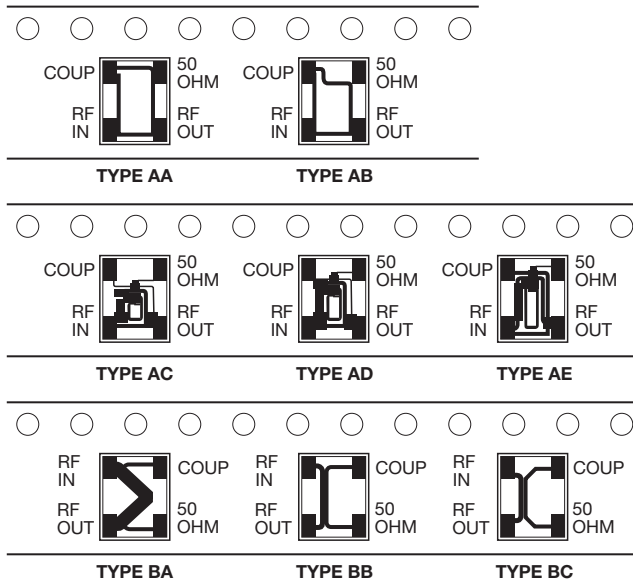

The parts should be mounted on the PCB with White (Alumina) side down and the "dark" side up.

CP0805xxxxxxSTR (Sn100) (Top View)

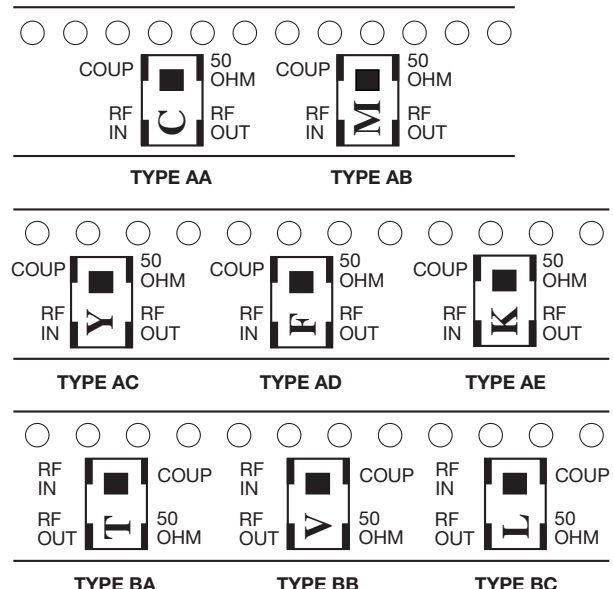

The parts should be mounted on the PCB with printed side up.



Thin-Film Directional Couplers

DB0603N 3dB 90° Couplers



GENERAL DESCRIPTION RFAP TECHNOLOGY

The DB0603N 3dB 90° Coupler is based on thin-film multilayer technology. The technology provides a miniature part with excellent high frequency performance and rugged construction for reliable automatic assembly. The RFAP LGA 3dB 90° Coupler will be offered in a variety of frequency bands compatible with various types of high frequency wireless systems.



APPLICATIONS

- Balanced Amplifiers and Signal Distribution in Wireless Communications

FEATURES

- Miniature 0603 size
- Low I. Loss
- High Isolation
- Surface Mountable
- RoHS Compliant
- Supplied on T&R
- Power Rating:
10W RF
Continuous

LAND GRID ARRAY ADVANTAGES:

- Inherent Low Profile
- Self Alignment during Reflow
- Excellent Solderability
- Low Parasitics
- Better Heat Dissipation

DIMENSIONS:

millimeters (inches)

| | |
|---|----------------------------|
| L | 1.60±0.10 (0.063±0.004) |
| W | 0.84±0.10 (0.033±0.004) |
| T | 0.60±0.10 (0.024±0.004) |
| A | 0.25±0.05 (0.010±0.002) |
| B | 0.20±0.05 (0.008±0.002) |
| S | 0.05±0.05 (0.002±0.002) |

Bottom View

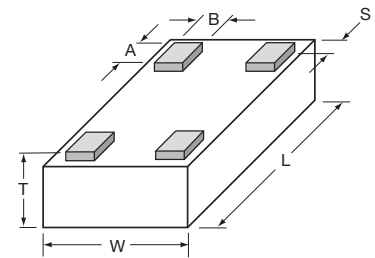

Recommended Pad Layout Dimensions mm (inches)

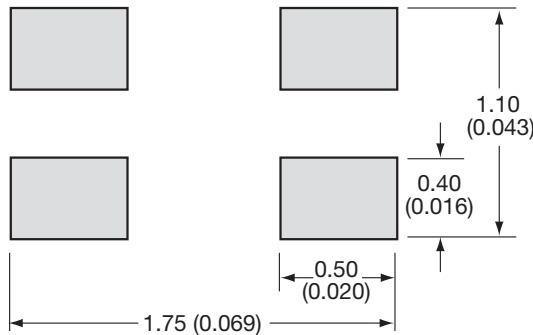

ORIENTATION IN TAPE

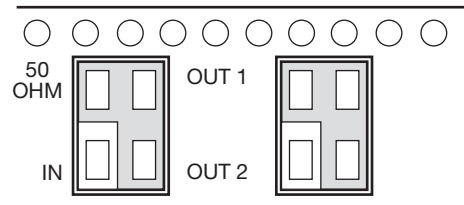

ELECTRICAL PARAMETERS

| Part Number | Frequency MHz | | Port Impedance Ω | Return Loss [dB] | | Isolation [dB] | | Insertion Loss [dB] | | Amplitude Balance [dB] | | Phase Balance (Relative to 90°) Deg | | Power Handling Watts |
|-----------------|---------------|------|------------------|------------------|------|----------------|------|---------------------|------|------------------------|------|-------------------------------------|------|----------------------|
| | Min. | Max. | | Typ. | Min. | Typ. | Min. | Typ. | Typ. | Max. | Typ. | Max. | Typ. | |
| DB0603N2140ANTR | 2040 | 2240 | 50 | 15 | 26 | 15 | 23 | 0.30 | 0.40 | 0.50 | 0.80 | 2 | 3 | 10 |
| DB0603N2400ANTR | 2300 | 2500 | 50 | 12 | 17 | 15 | 23 | 0.25 | 0.35 | 0.30 | 0.80 | 2 | 3 | 10 |
| DB0603N2600ANTR | 2400 | 2800 | 50 | 12 | 17 | 15 | 23 | 0.25 | 0.35 | 0.30 | 0.80 | 2 | 3 | 10 |
| DB0603N3000ANTR | 2850 | 3150 | 50 | 12 | 15 | 15 | 26 | 0.20 | 0.30 | 0.30 | 0.80 | 2 | 3 | 10 |
| DB0603N3500ANTR | 3300 | 3700 | 50 | 12 | 15 | 15 | 26 | 0.20 | 0.30 | 0.30 | 0.80 | 2 | 3 | 10 |
| DB0603N4600ANTR | 4200 | 5000 | 50 | 12 | 16 | 12 | 15 | 0.50 | 0.70 | 0.40 | 1.00 | 1.5 | 3 | 10 |
| DB0603N5500ANTR | 5100 | 5900 | 50 | 12 | 16 | 10 | 14 | 0.60 | 0.80 | 0.80 | 1.50 | 1 | 3 | 10 |
| DB0603N5800ANTR | 5600 | 6000 | 50 | 12 | 16 | 12 | 17 | 0.40 | 0.90 | 0.30 | 0.90 | 2 | 3 | 10 |

NOTE: Additional Frequencies Available Upon Request

Thin-Film Directional Couplers

DB0603N 3dB 90° Couplers



2040MHz to 2240MHz DB0603N2140ANTR

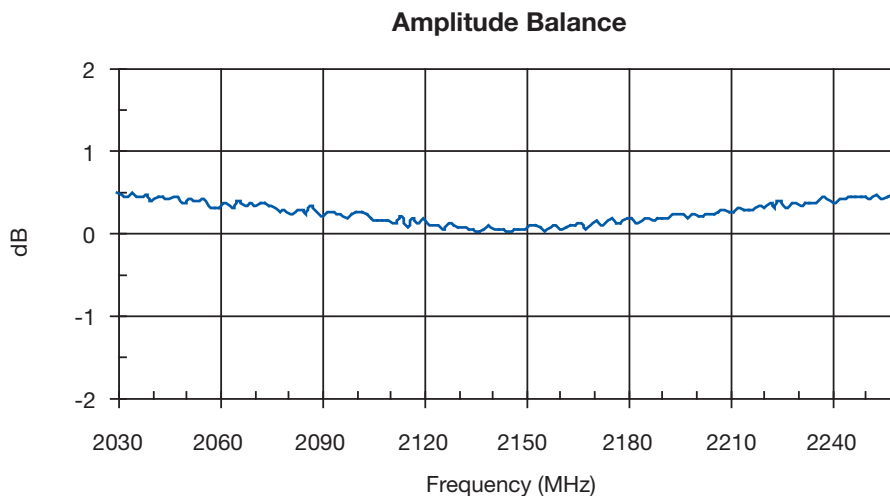
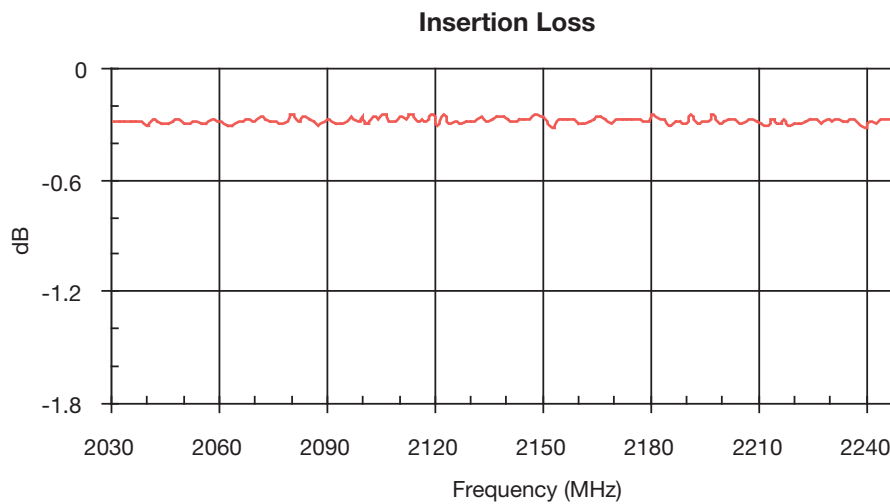
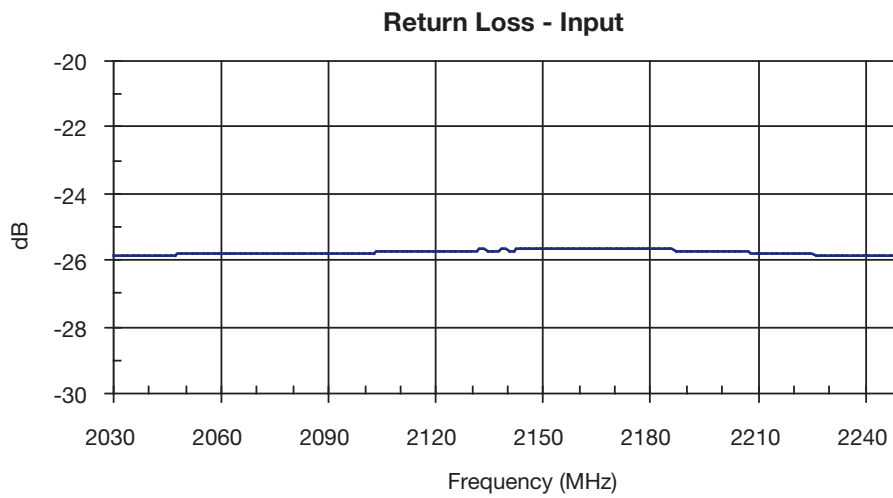

3

Thin-Film Directional Couplers

DB0603N 3dB 90° Couplers



2040MHz to 2240MHz DB0603N2140ANTR

Phase Balance

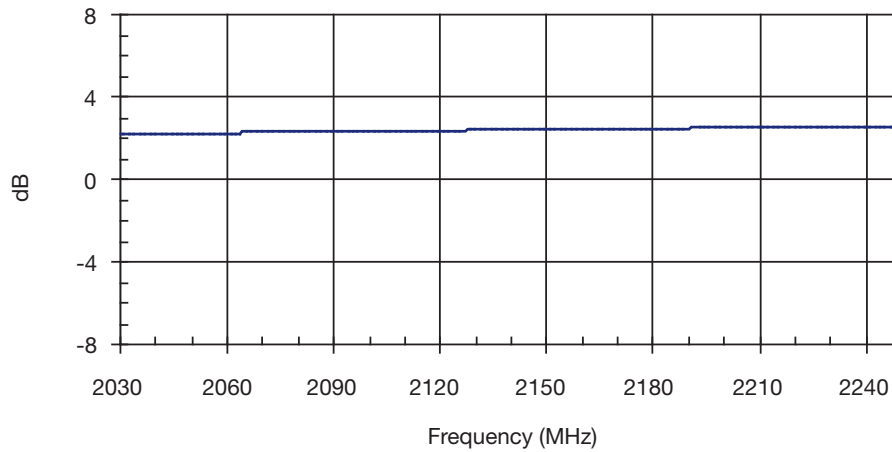

Isolation

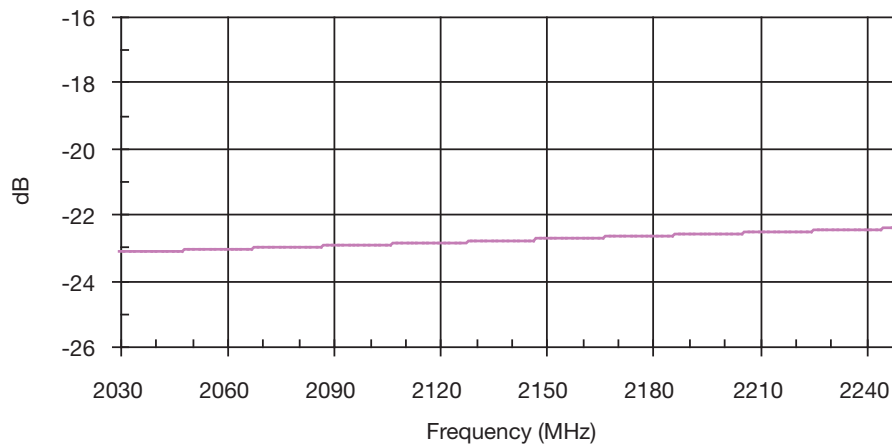

3



Thin-Film Directional Couplers

DB0603N 3dB 90° Couplers



2200MHz to 2600MHz DB0603N2400ANTR

Return Loss - Input

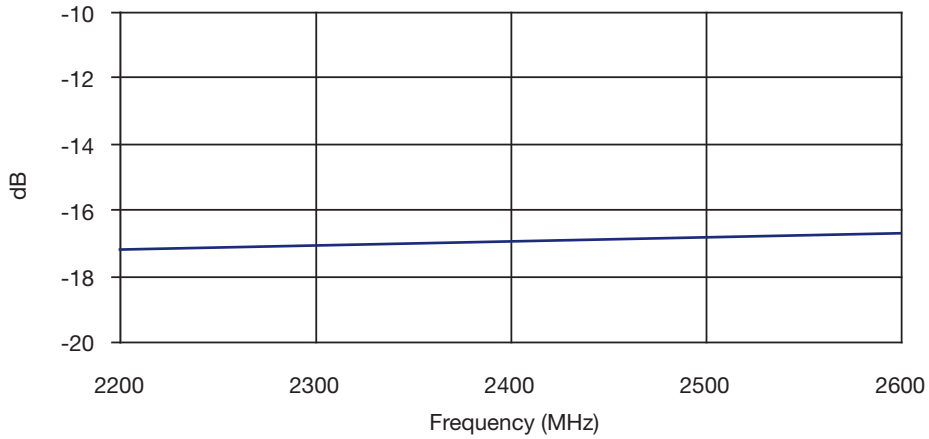

Insertion Loss

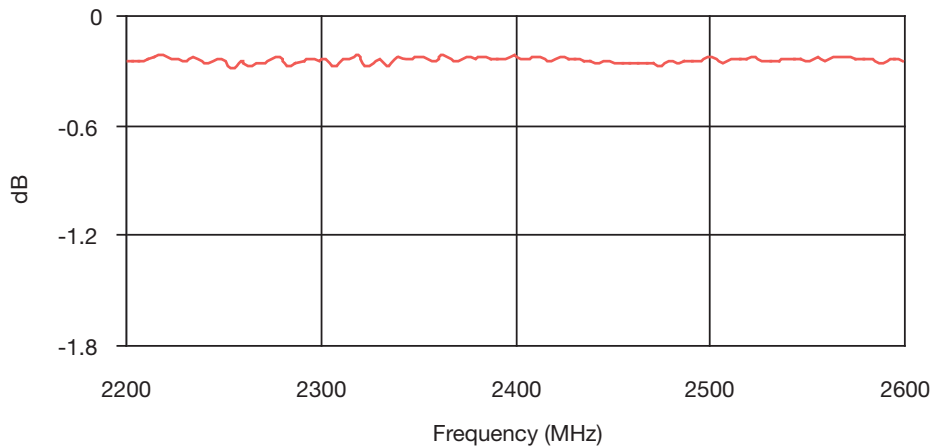

Amplitude Balance

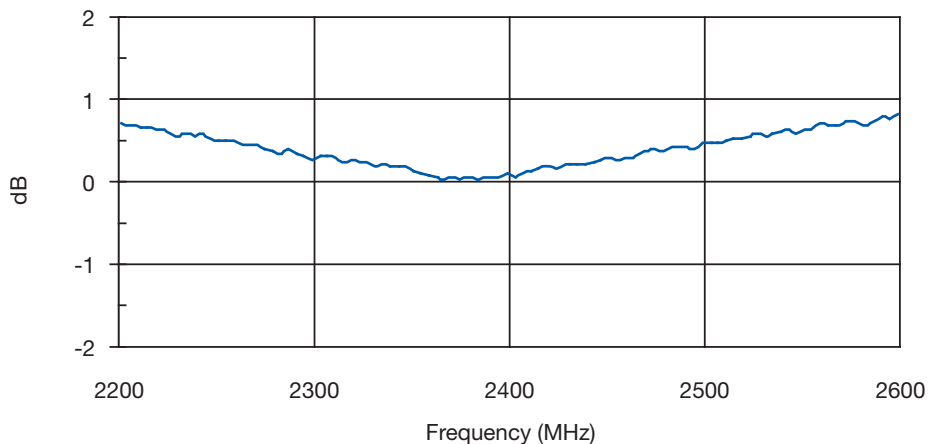

3

Thin-Film Directional Couplers

DB0603N 3dB 90° Couplers



2200MHz to 2600MHz DB0603N2400ANTR

Phase Balance

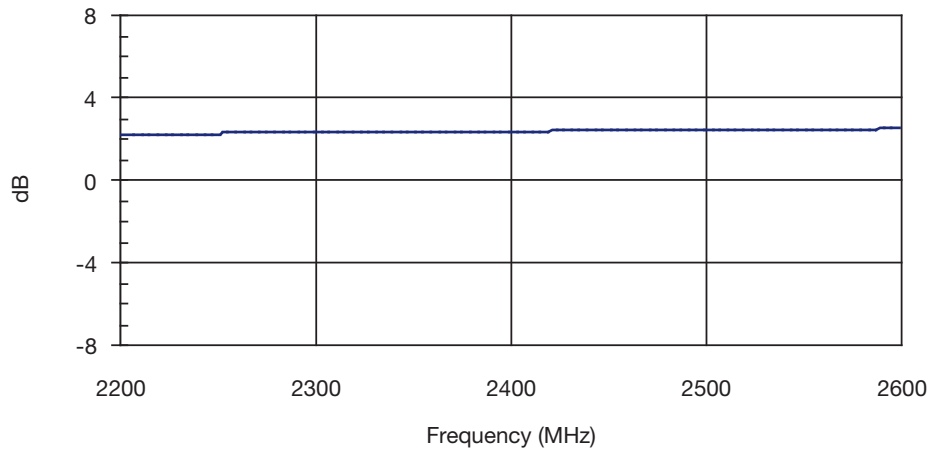

Isolation

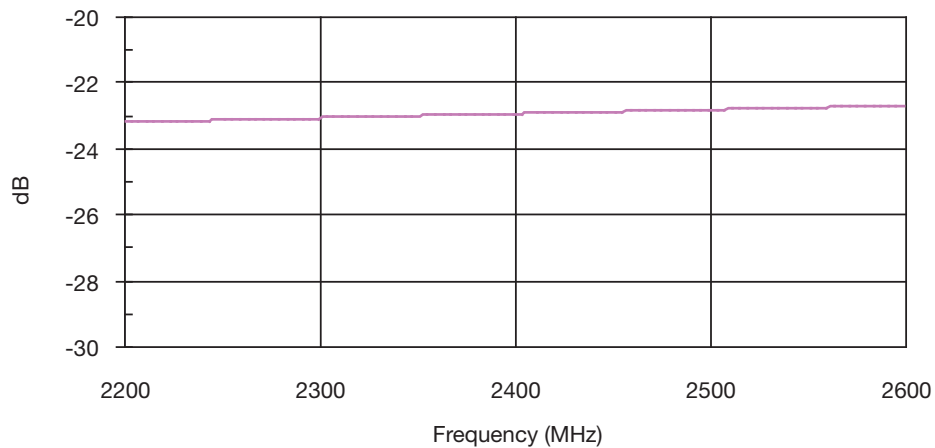

3



Thin-Film Directional Couplers

DB0603N 3dB 90° Couplers



2400MHz TO 2800MHz DB0603N2600ANTR

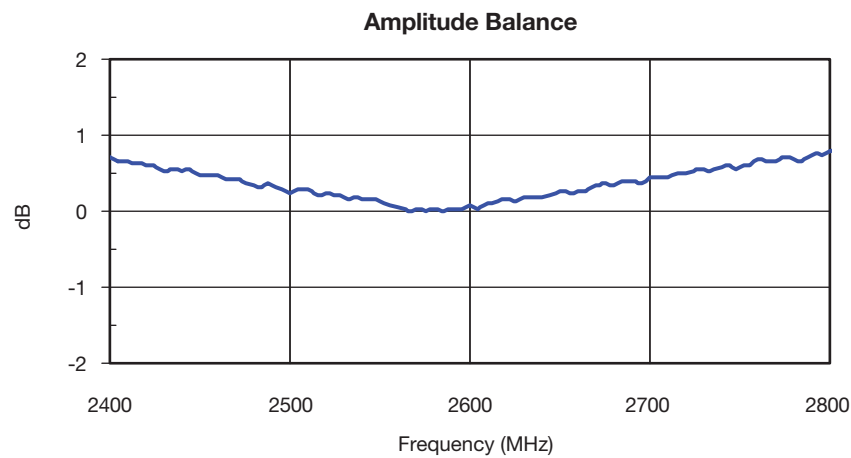
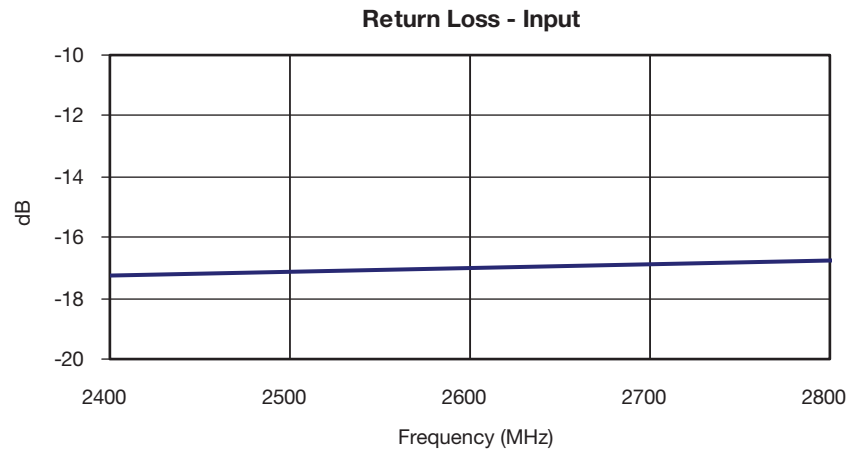

3

Thin-Film Directional Couplers

DB0603N 3dB 90° Couplers



2400MHz TO 2800MHz DB0603N2600ANTR

Phase Balance

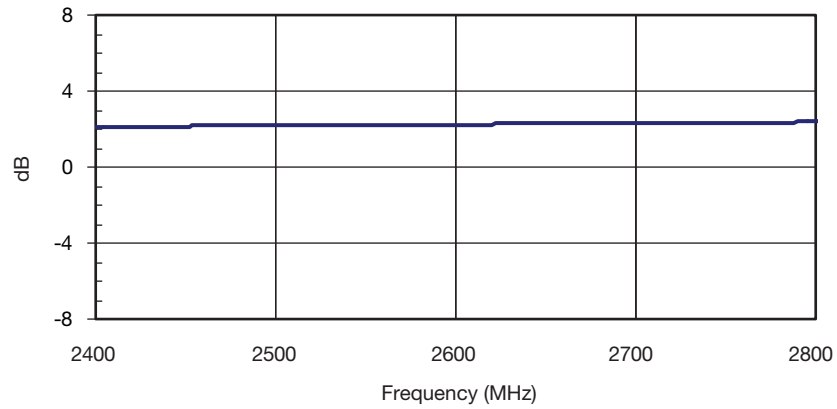

Isolation

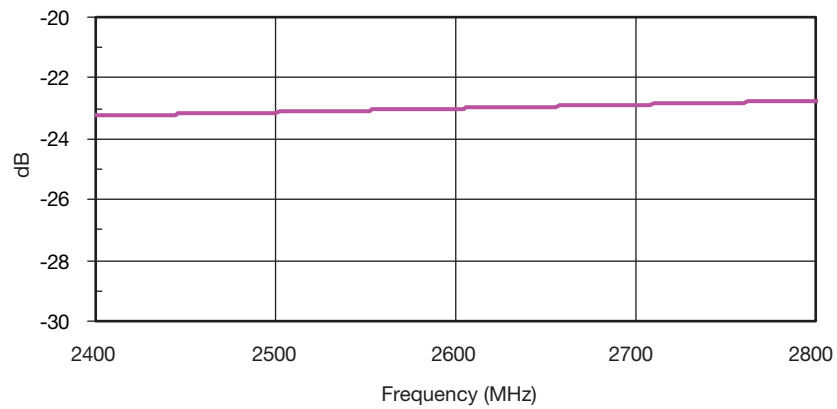

3



Thin-Film Directional Couplers

DB0603N 3dB 90° Couplers



2850MHz to 3150MHz DB0603N3000ANTR

Return Loss - Input

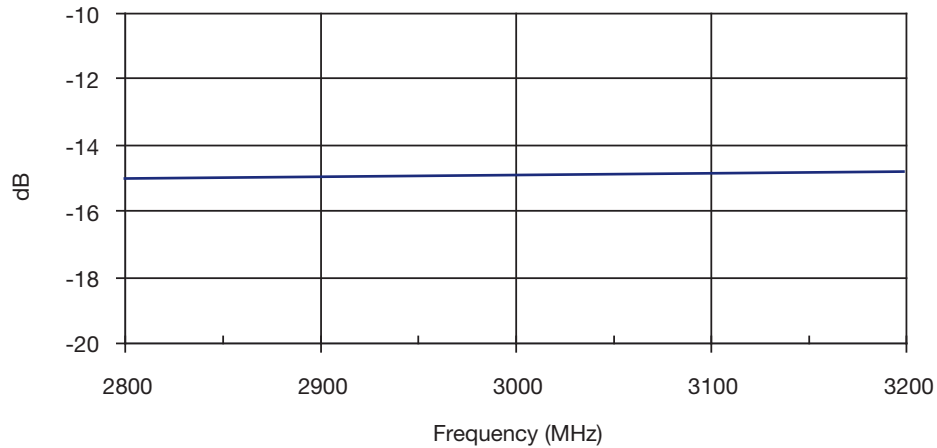

Insertion Loss

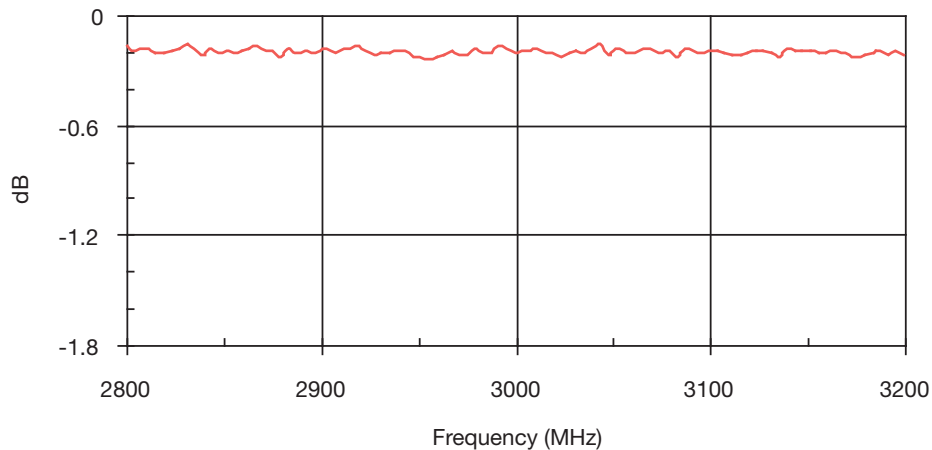

Amplitude Balance

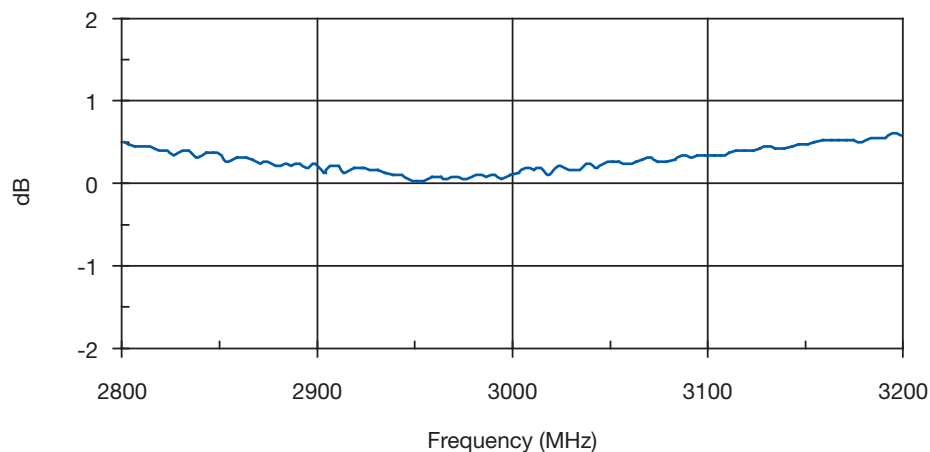

3

Thin-Film Directional Couplers

DB0603N 3dB 90° Couplers



2850MHz to 3150MHz DB0603N3000ANTR

Phase Balance

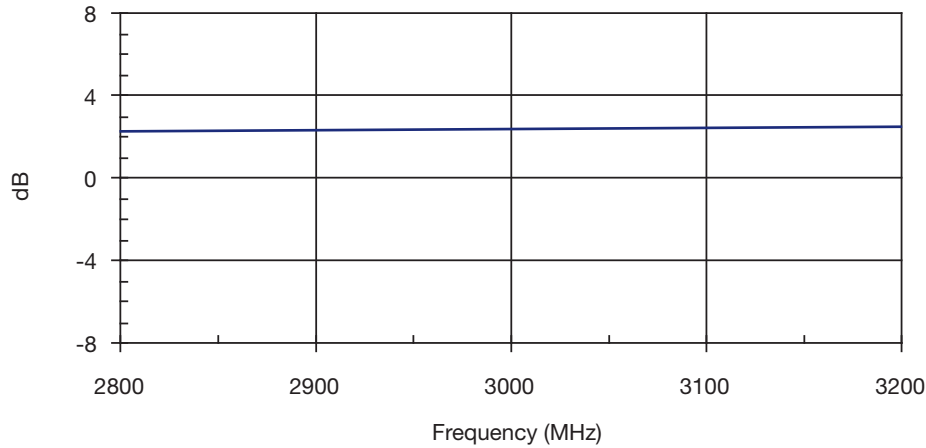

Isolation

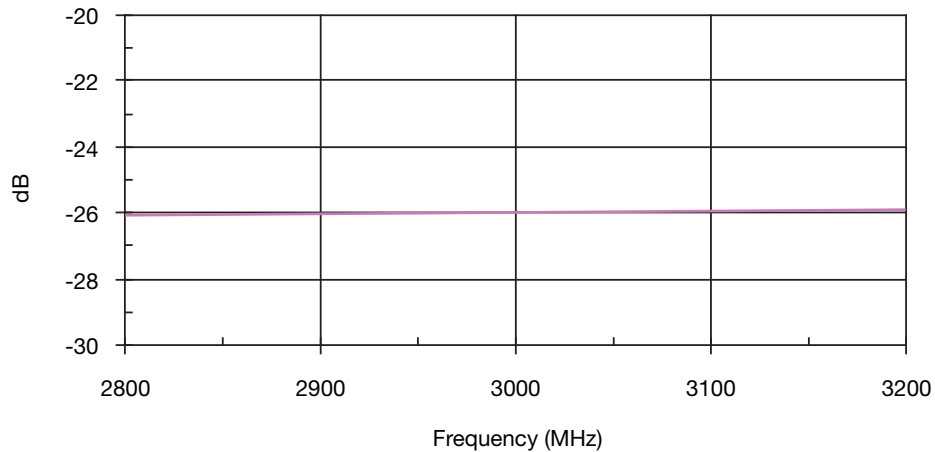

3



Thin-Film Directional Couplers

DB0603N 3dB 90° Couplers



3200MHz to 3800MHz DB0603N3500ANTR

Return Loss - Input

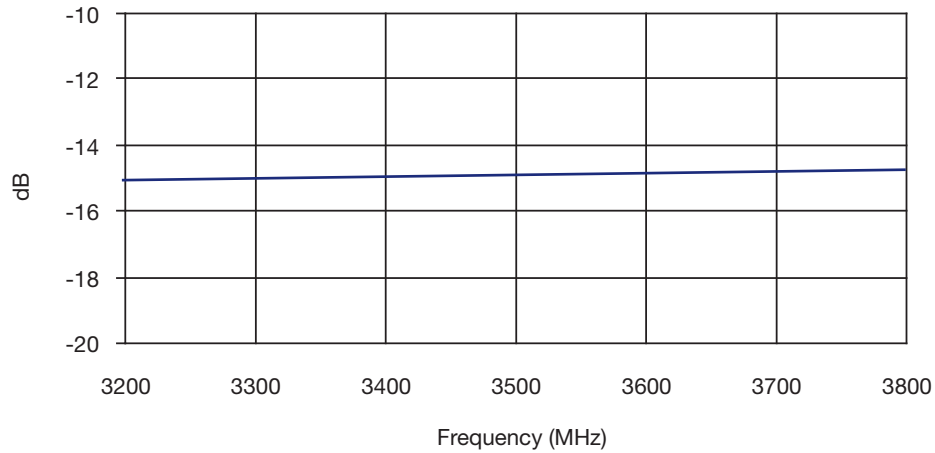

Insertion Loss

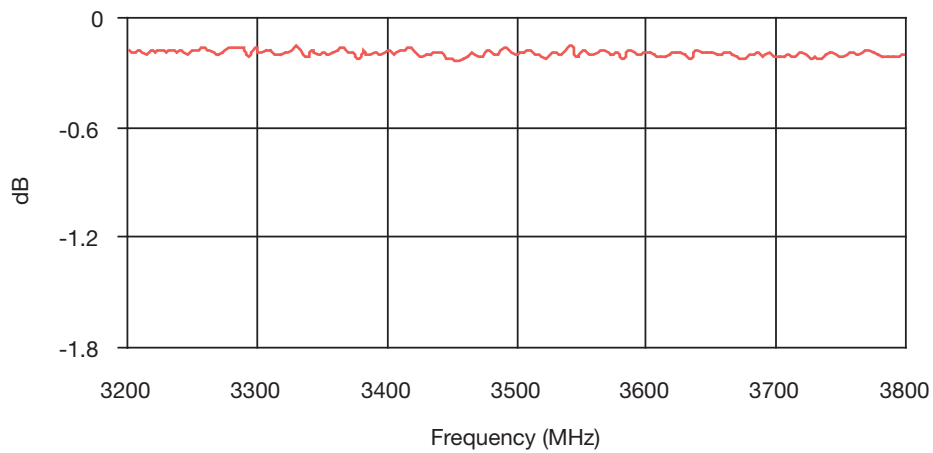

Amplitude Balance

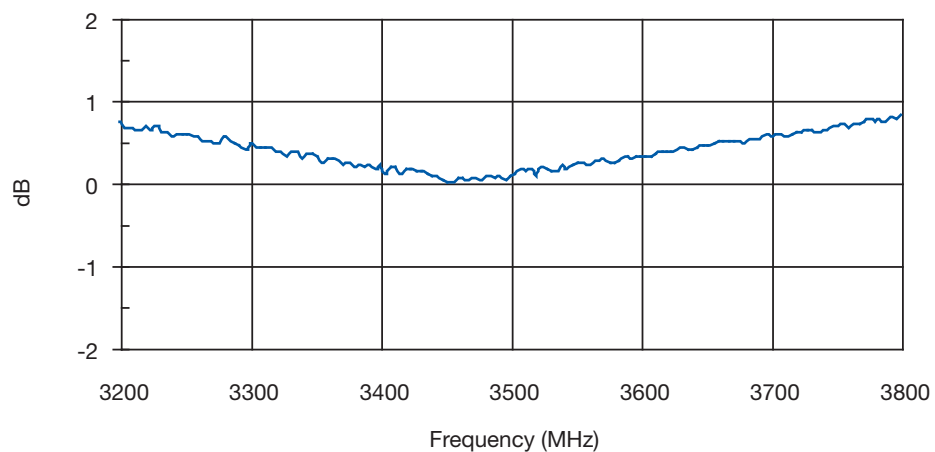

3

Thin-Film Directional Couplers

DB0603N 3dB 90° Couplers



3200MHz to 3800MHz DB0603N3500ANTR

Phase Balance

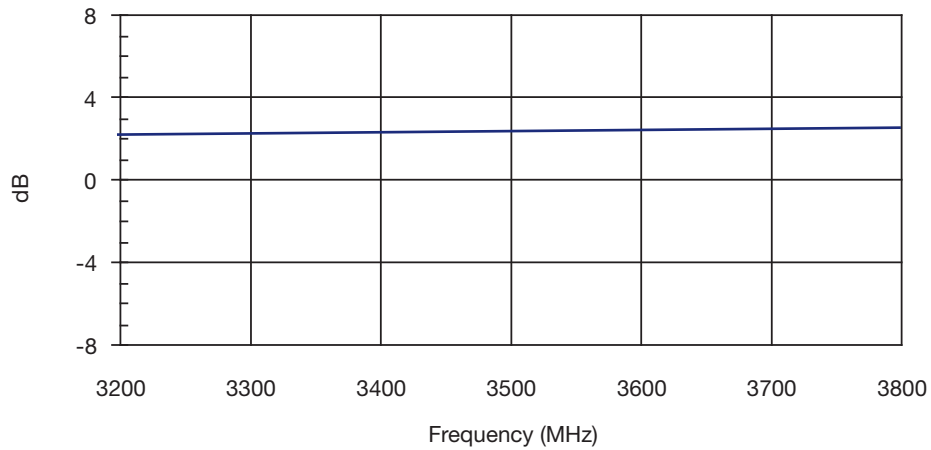

Isolation

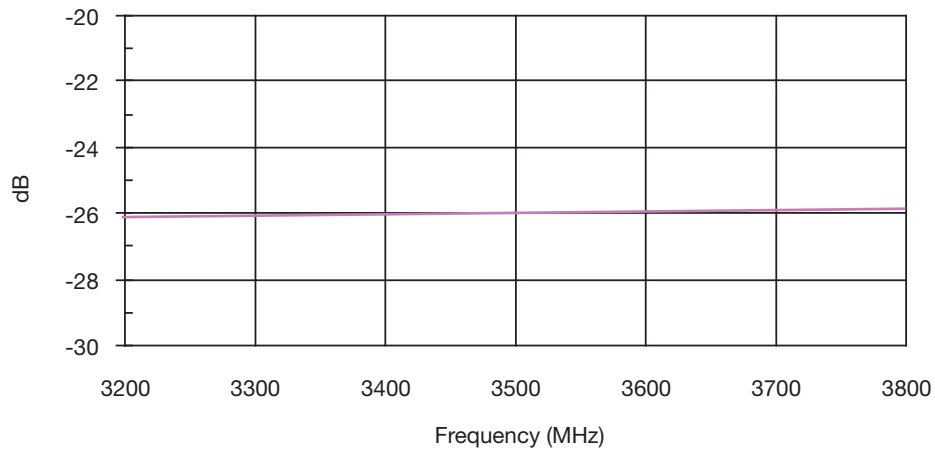

3

Thin-Film Directional Couplers

DB0603N 3dB 90° Couplers



4200MHz TO 5000MHz DB0603N4600ANTR

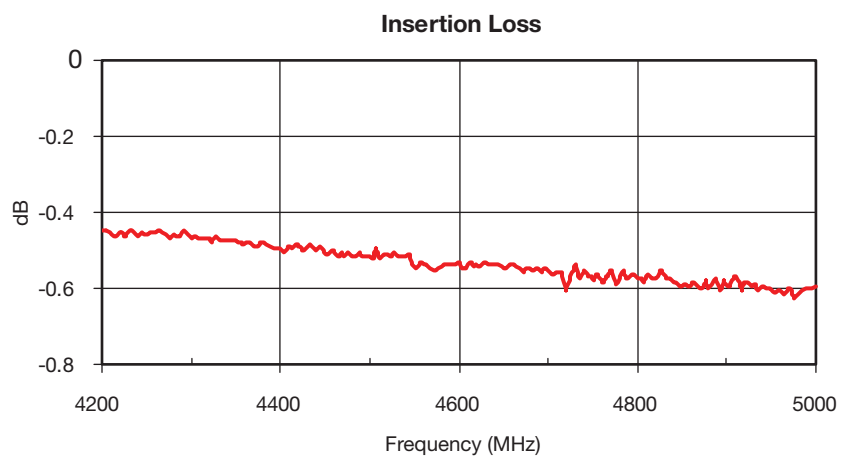
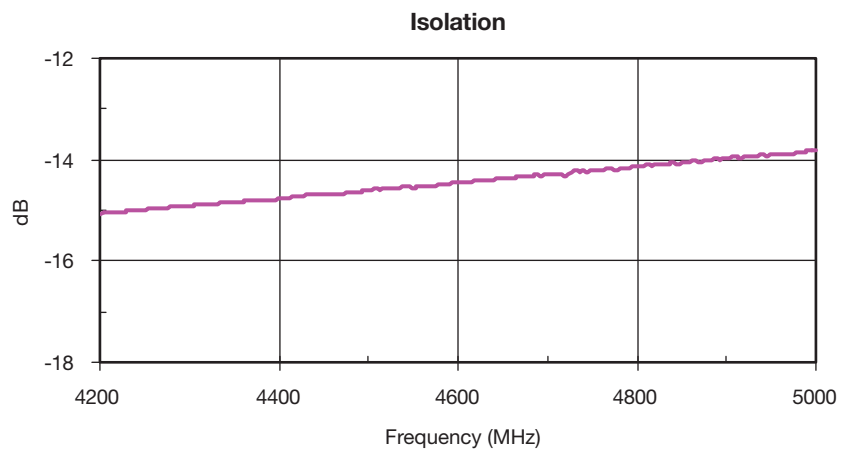
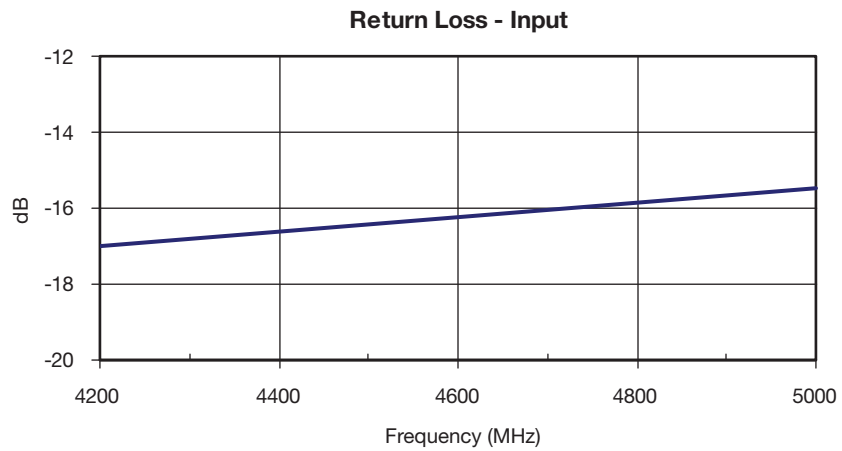

3

Thin-Film Directional Couplers

DB0603N 3dB 90° Couplers



4200MHz TO 5000MHz DB0603N4600ANTR

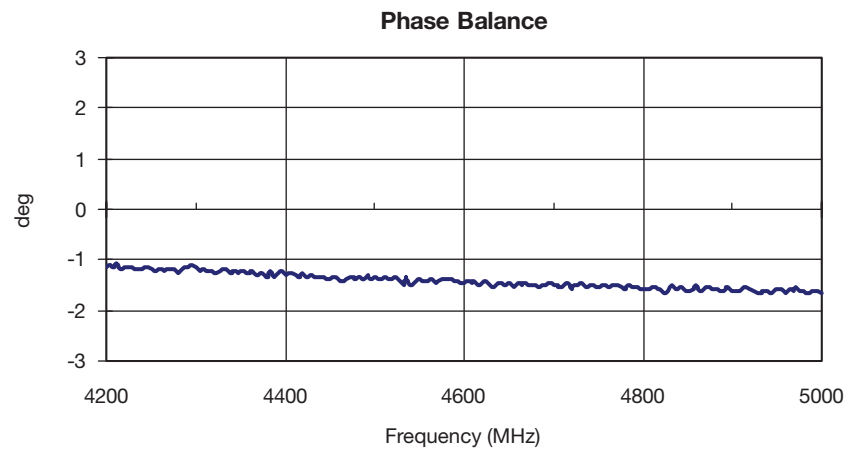
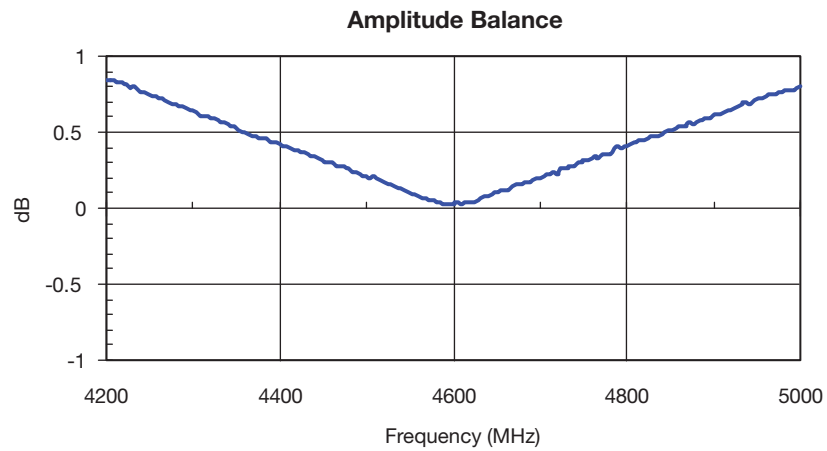

3



Thin-Film Directional Couplers

DB0603N 3dB 90° Couplers



5100MHz TO 5900MHz DB0603N5500ANTR

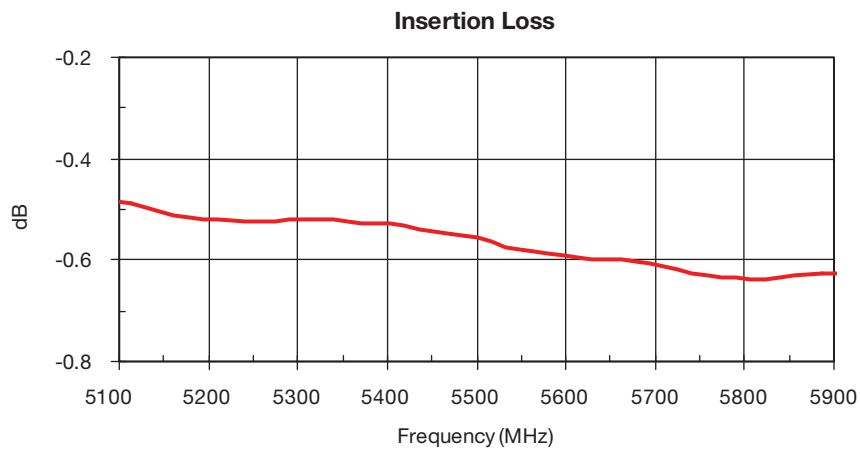
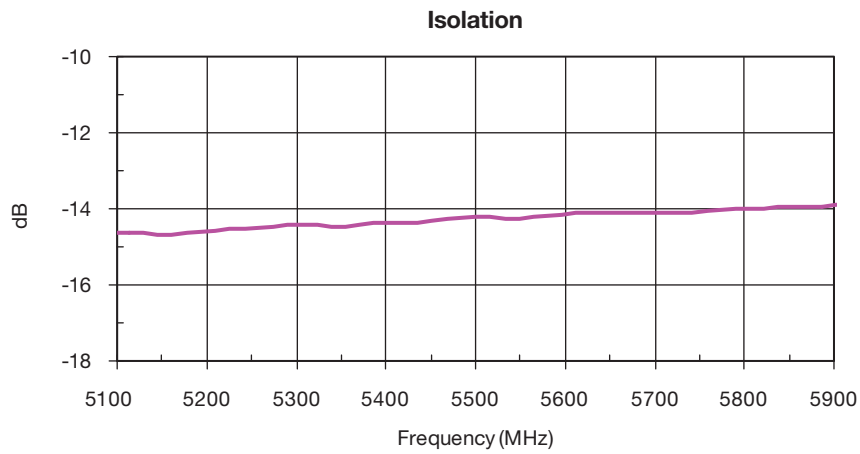
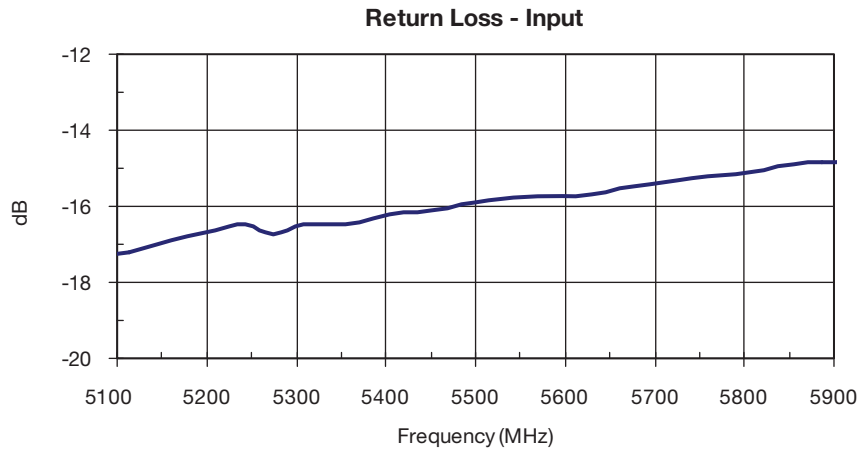

3

Thin-Film Directional Couplers

DB0603N 3dB 90° Couplers



5100MHz TO 5900MHz DB0603N5500ANTR

Amplitude Balance

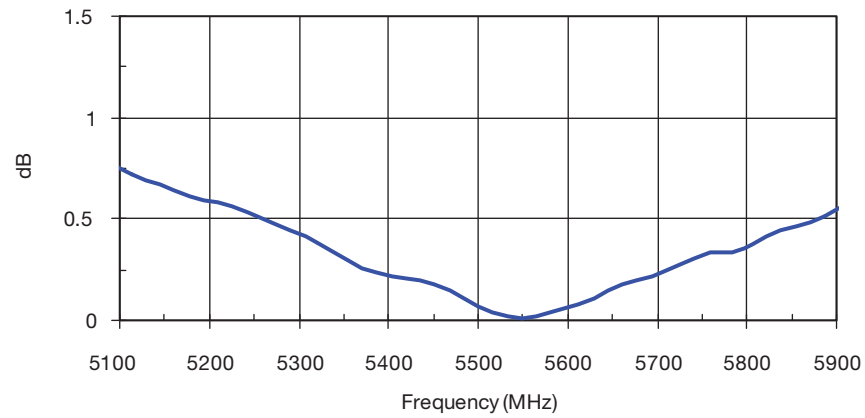

Phase Balance

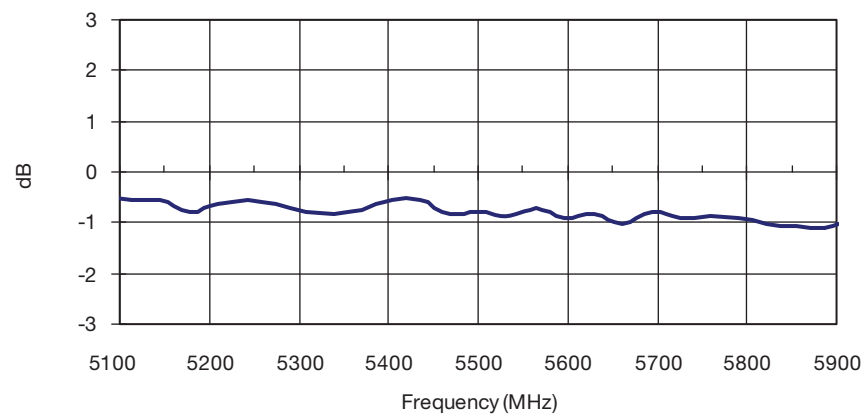

3



Thin-Film Directional Couplers

DB0603N 3dB 90° Couplers



5600MHz TO 6000MHz DB0603N5800ANTR

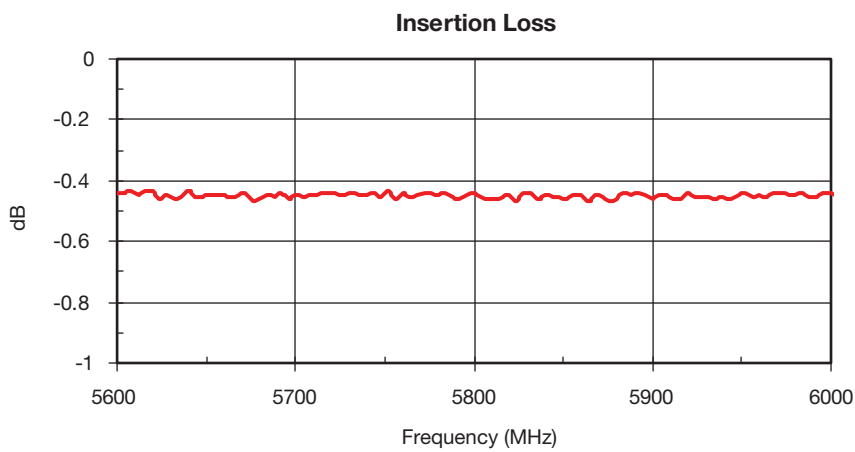
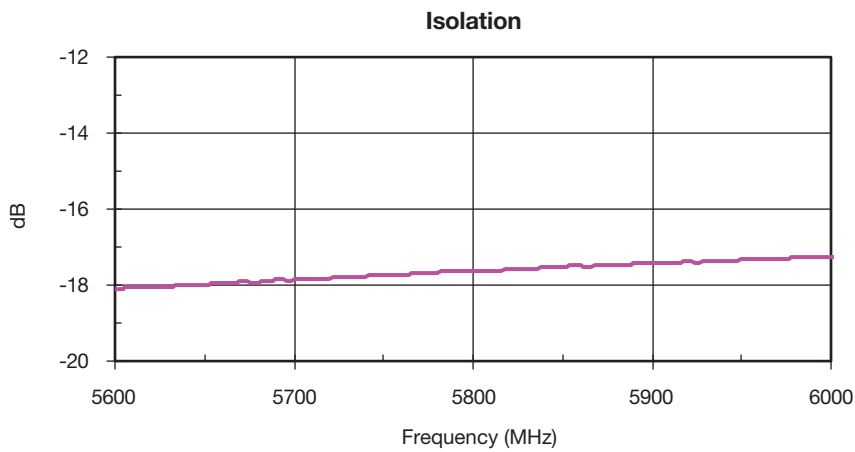
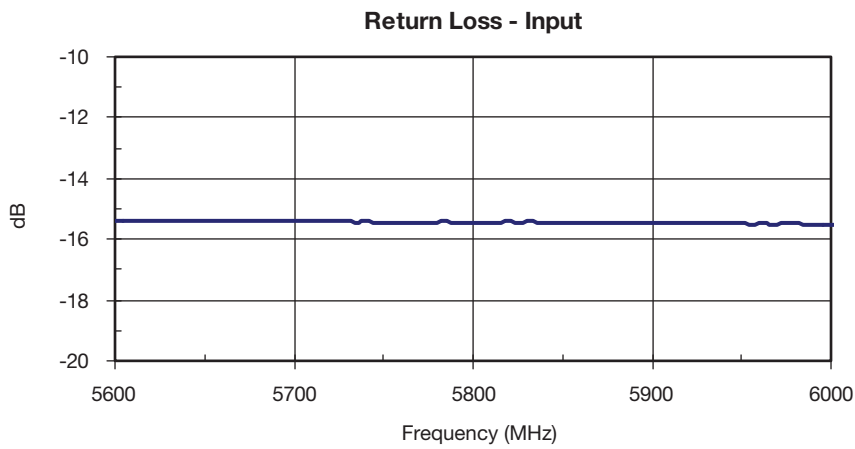

3

Thin-Film Directional Couplers

DB0603N 3dB 90° Couplers



5600MHz TO 6000MHz DB0603N5800ANTR

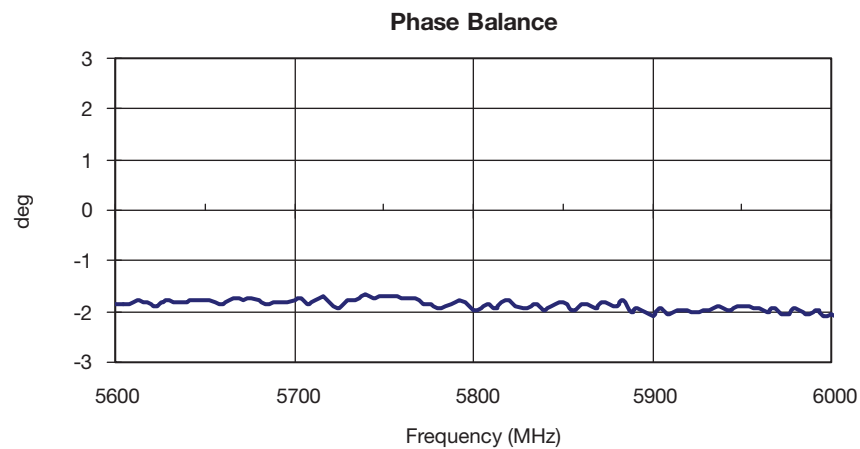
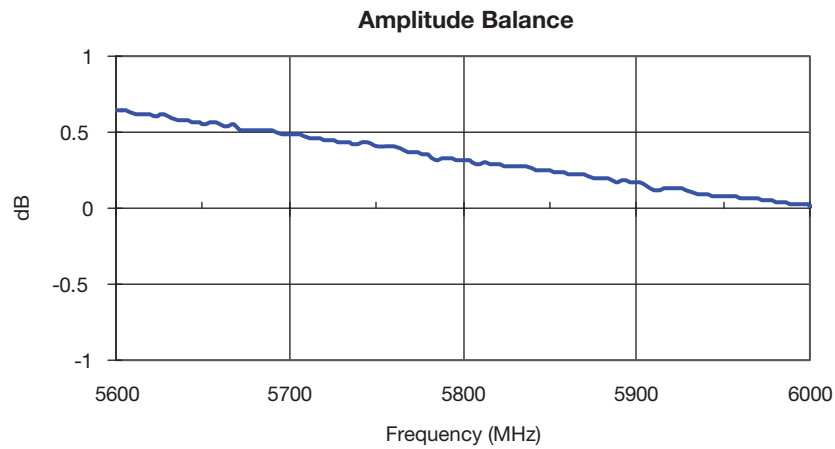

3

Thin-Film Directional Couplers

DB0805 3dB 90° Couplers



GENERAL DESCRIPTION ITF TECHNOLOGY

The ITF SMD 3dB 90° Coupler is based on thin-film multilayer technology. The technology provides a miniature part with excellent high frequency performance and rugged construction for reliable automatic assembly.

The ITF 3dB 90° Coupler is offered in a variety of frequency bands compatible with various types of high frequency wireless systems.

Recommended Pad Layout Dimensions mm (inches)

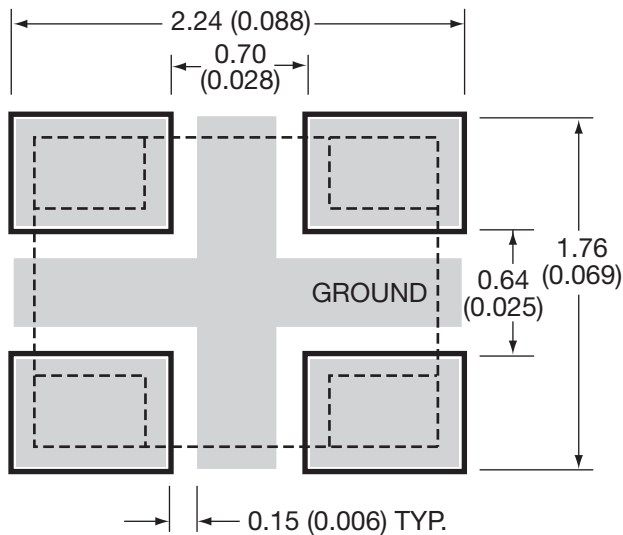

APPLICATIONS

- Balanced Amplifiers and Signal Distribution in Mobile Communications

FEATURES

- Miniature 0805 size
- Low I. Loss
- High Isolation
- Power Handling: 10W RF CW
- Surface Mountable
- Supplied on Tape and Reel
- Operating Temperature -40°C to +85°C

DIMENSIONS:

millimeters (inches)

| | |
|---|----------------------------|
| L | 2.03±0.10 (0.080±0.004) |
| W | 1.55±0.10 (0.061±0.004) |
| T | 0.98±0.15 (0.037±0.006) |
| A | 0.56±0.25 (0.022±0.010) |
| B | 0.35±0.15 (0.014±0.006) |

Bottom View

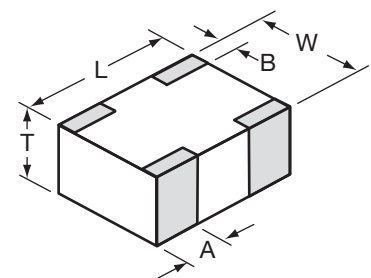

TERMINALS (Top View) Orientation in Tape

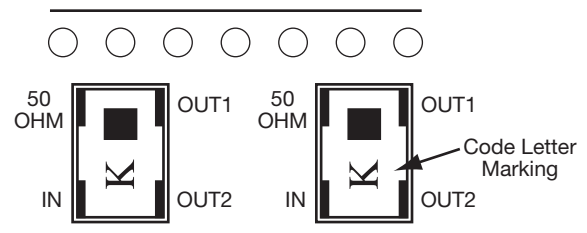

ELECTRICAL PARAMETERS*

| Part Number** | Frequency F ₀ [MHz] | I. Loss @ F ₀ [dB] | Phase Balance [deg] max. | Code Letter Marking |
|-----------------|--------------------------------|-------------------------------|--------------------------|---------------------|
| DB0805A0880ASTR | 880±30 | 0.35 | 3 | Y |
| DB0805A0915ASTR | 915±30 | 0.35 | 3 | V |
| DB0805A0967ASTR | 967±30 | 0.35 | 3 | V |
| DB0805A1350ASTR | 1350±50 | 0.35 | 3 | C |
| DB0805A1650ASTR | 1650±50 | 0.35 | 3 | F |
| DB0805A1800ASTR | 1800±50 | 0.30 | 3 | F |
| DB0805A1850ASTR | 1850±50 | 0.30 | 3 | K |
| DB0805A1900ASTR | 1900±50 | 0.30 | 3 | K |
| DB0805A1950ASTR | 1950±50 | 0.25 | 3 | K |
| DB0805A2140ASTR | 2140±50 | 0.25 | 3 | L |
| DB0805A2325ASTR | 2325±50 | 0.25 | 3 | T |

*With Recommended Pad Layout

NOTE: Additional Frequencies Available Upon Request

****LEAD FREE TERMINATION
PART NUMBERS:
DB0805AxxxxASTR**



Thin-Film Directional Couplers

DB0805 3dB 90° Couplers



880 ± 30MHz DB0805A0880ASTR

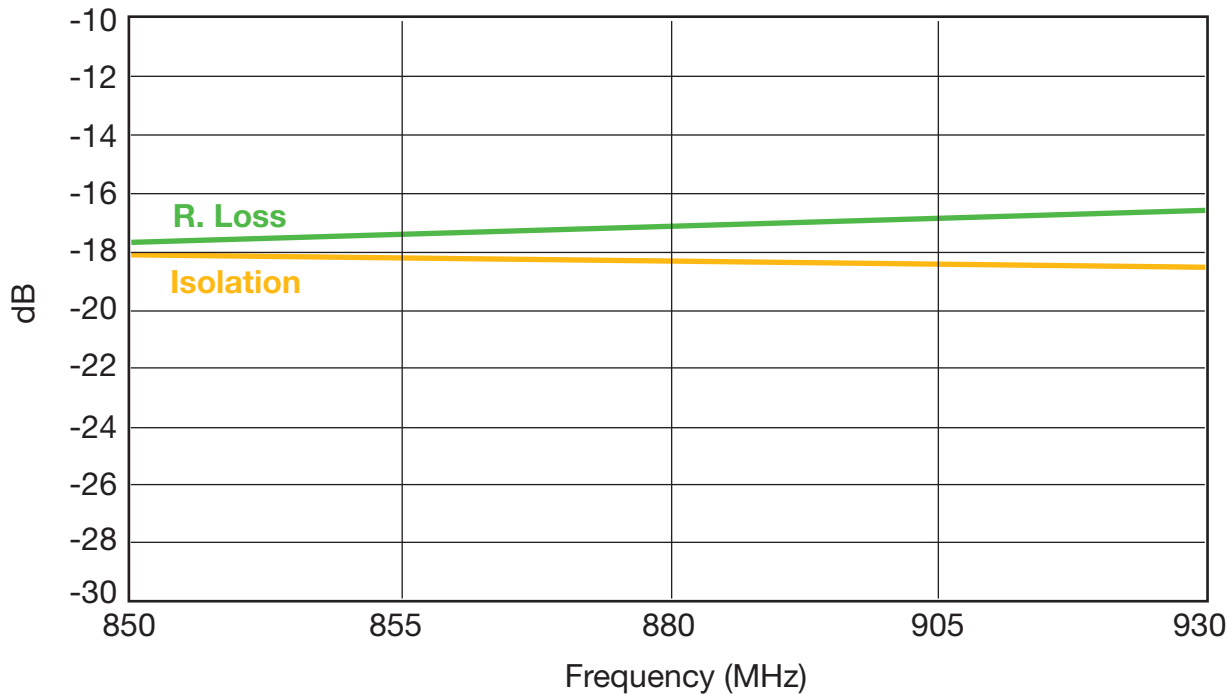
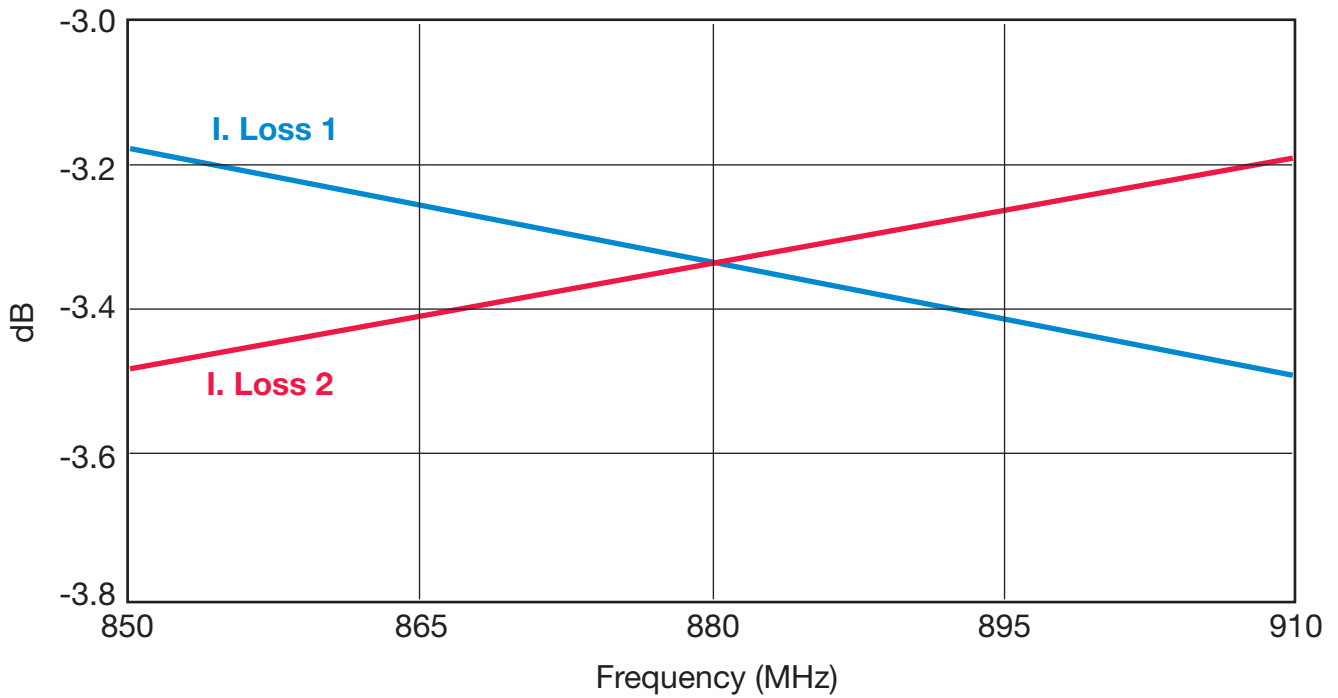

3



Thin-Film Directional Couplers

DB0805 3dB 90° Couplers



915 ± 30MHz DB0805A0915ASTR

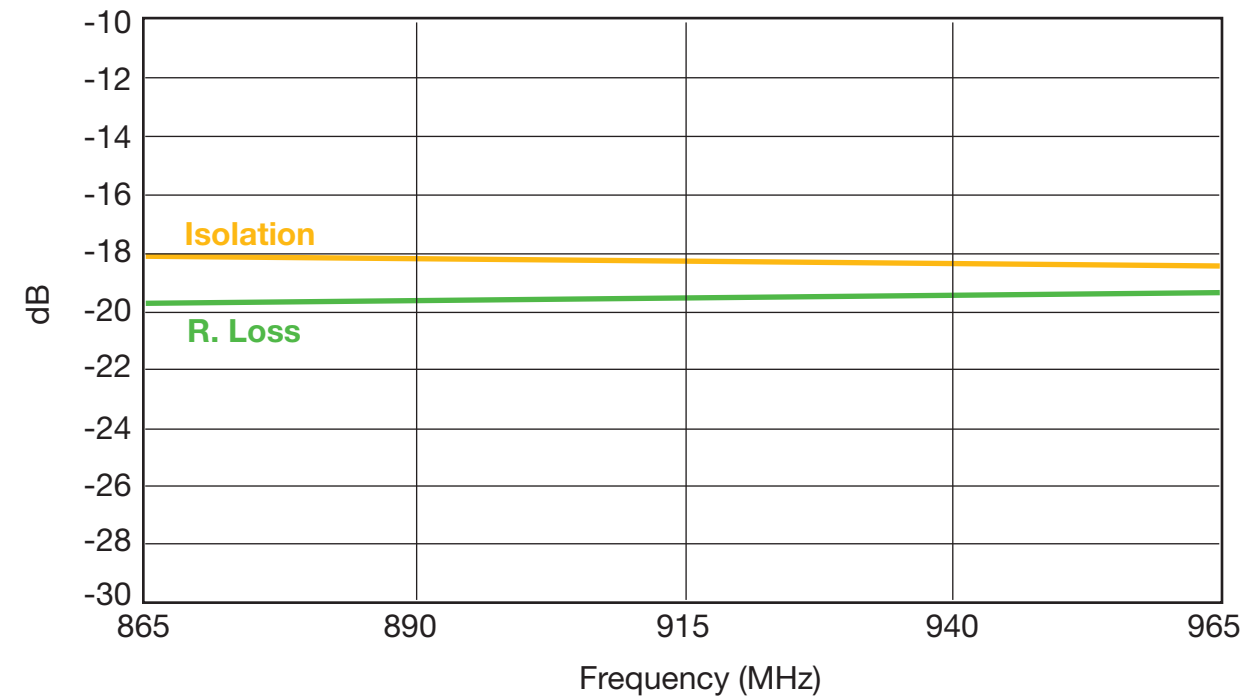
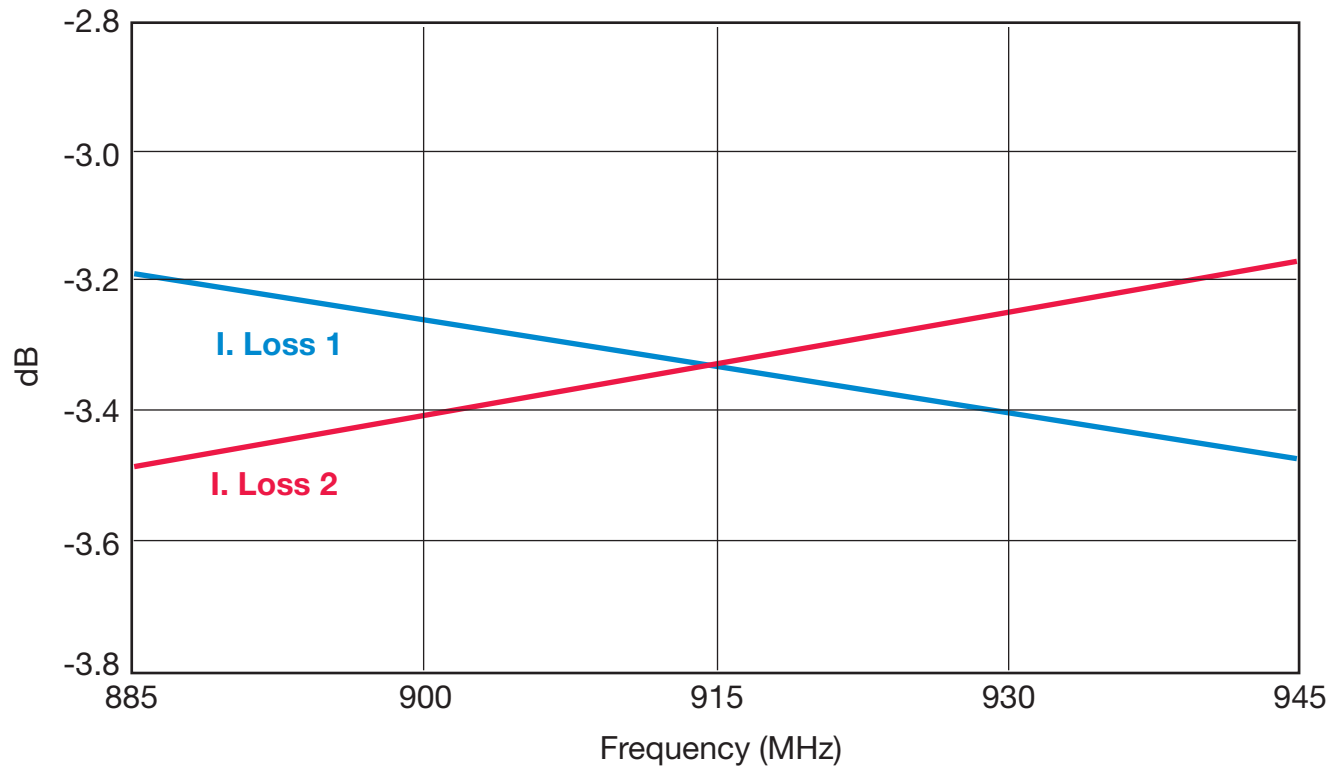

3

Thin-Film Directional Couplers

DB0805 3dB 90° Couplers



967± 30MHz DB0805A0967ASTR

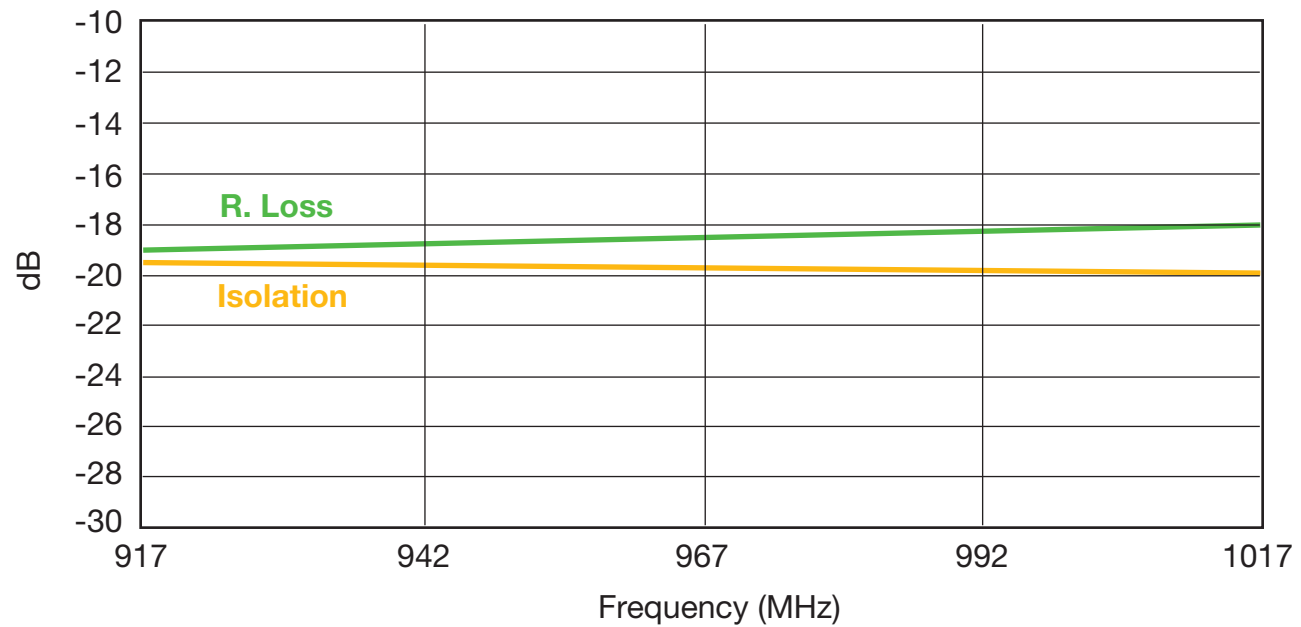
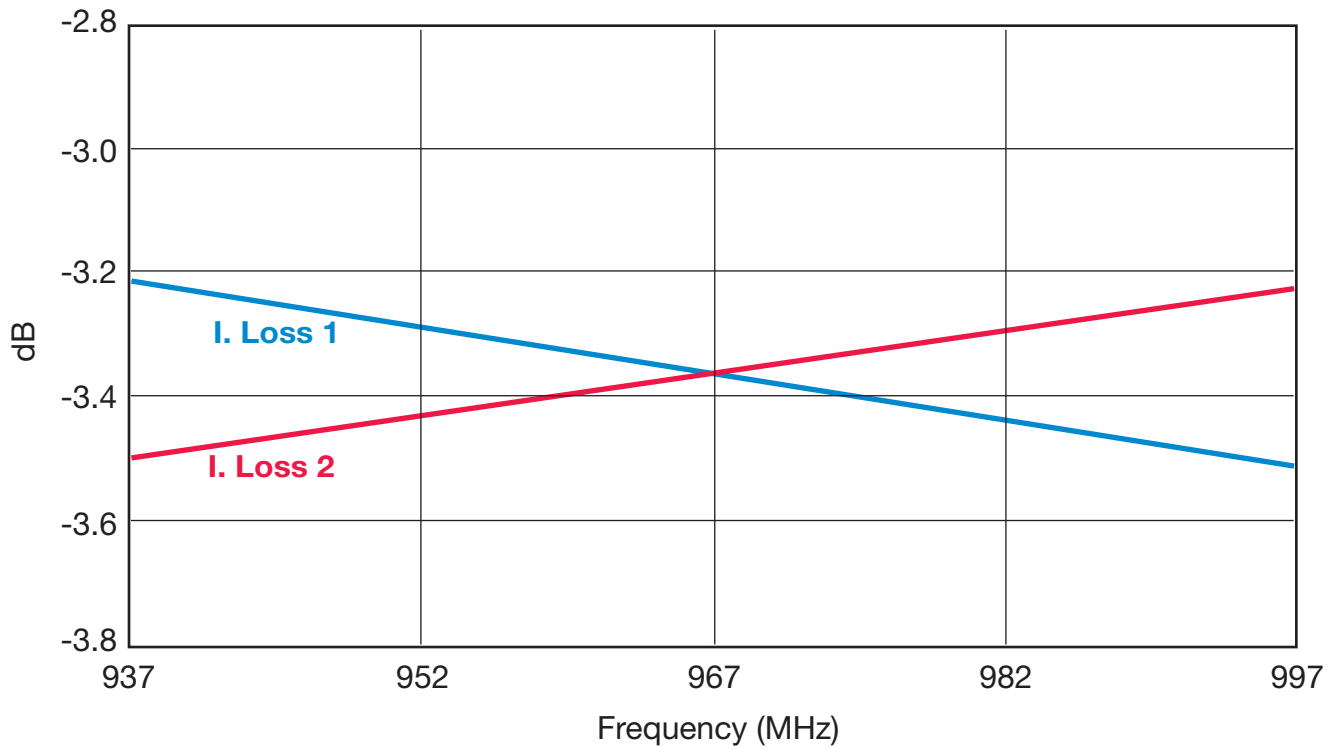

3



Thin-Film Directional Couplers

DB0805 3dB 90° Couplers



1350 ± 50MHz DB0805A1350ASTR

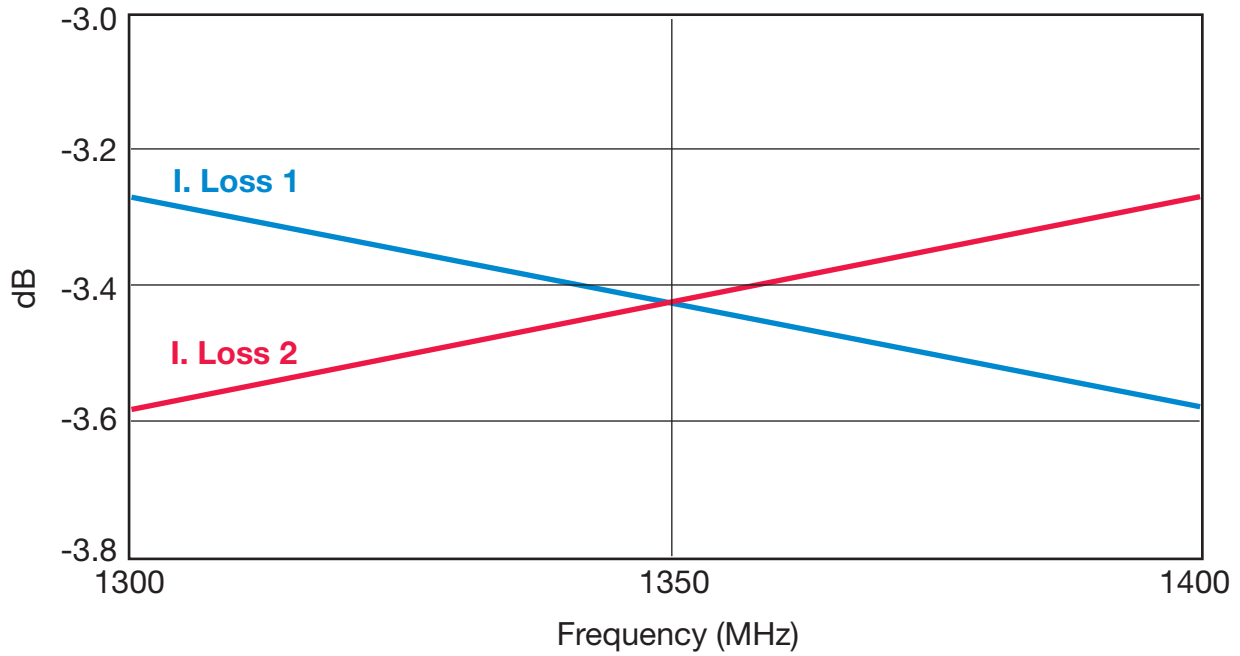

3

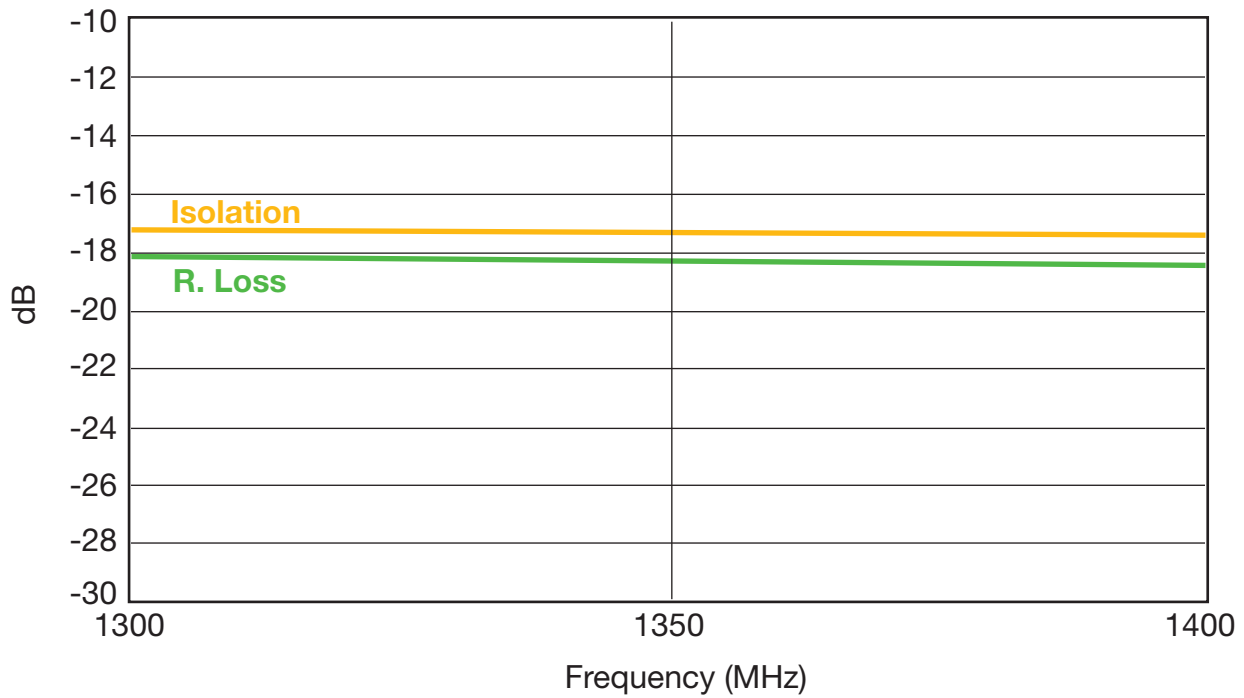

Thin-Film Directional Couplers

DB0805 3dB 90° Couplers



1650 ± 50MHz DB0805A1650ASTR

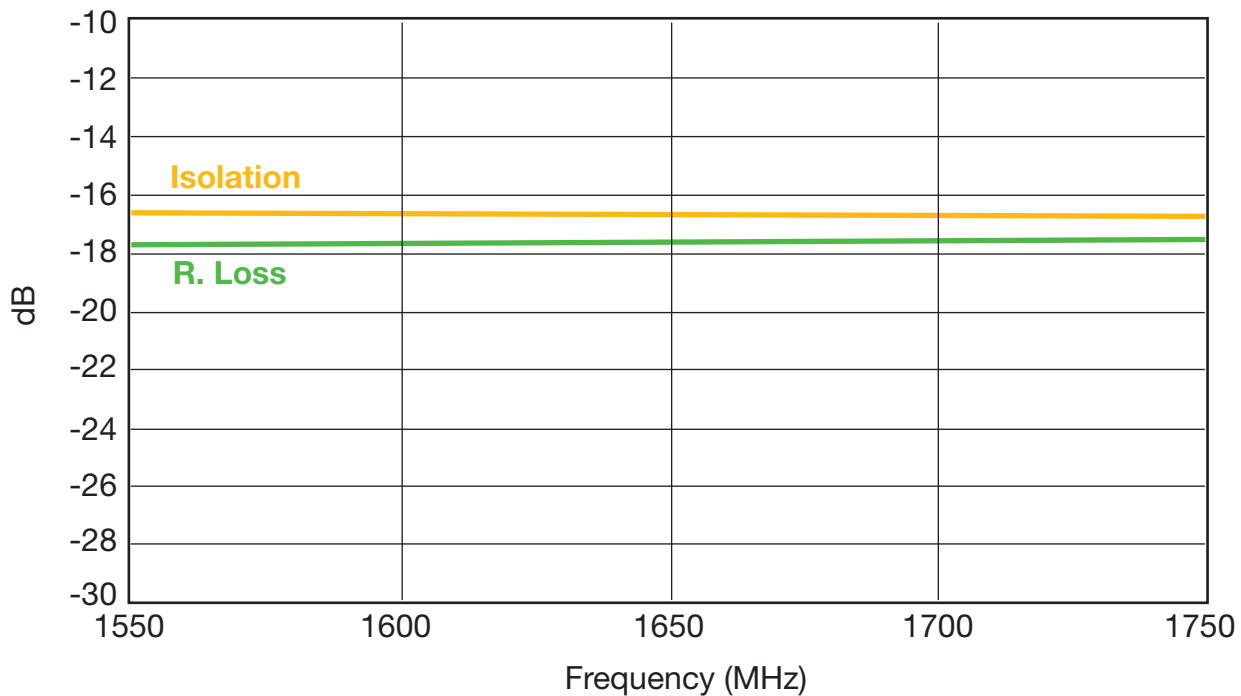
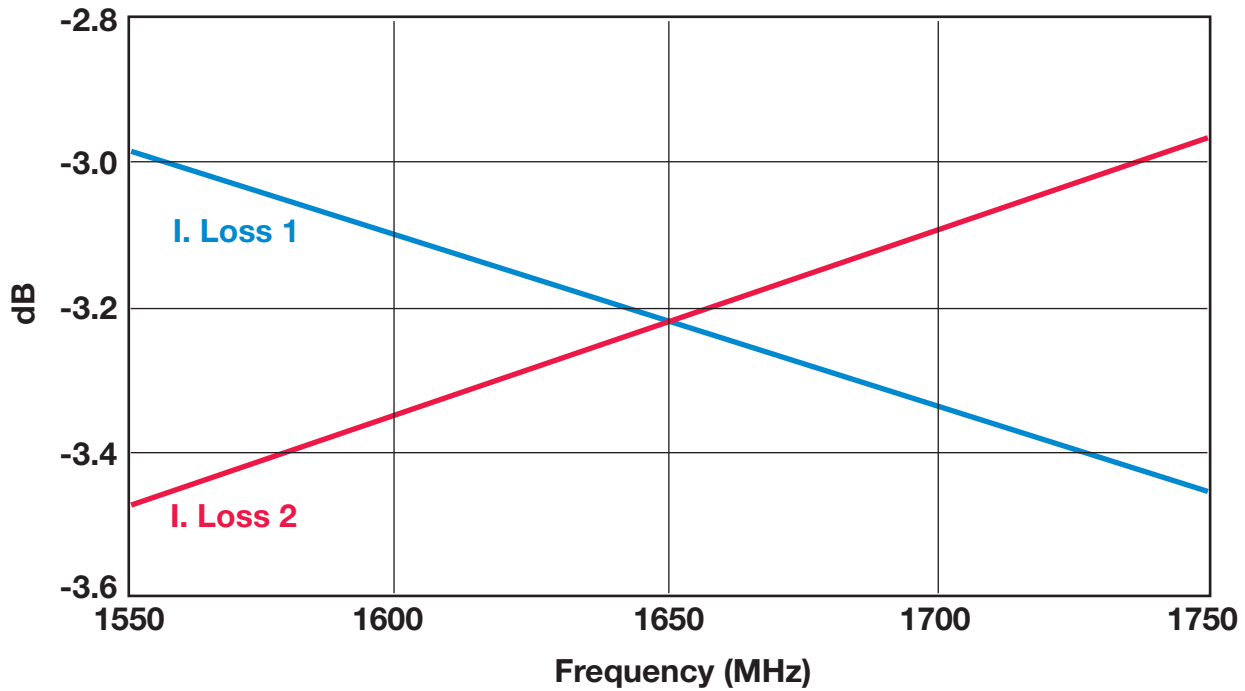

Thin-Film Directional Couplers

DB0805 3dB 90° Couplers



1800 ± 50MHz DB0805A1800ASTR

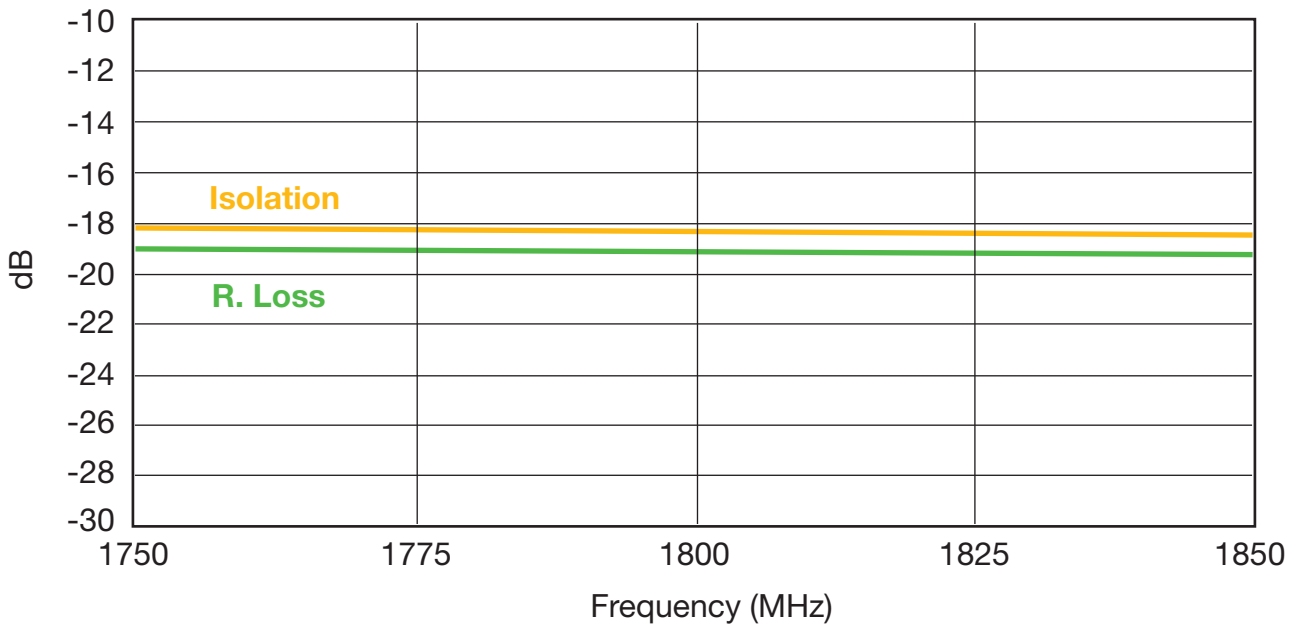
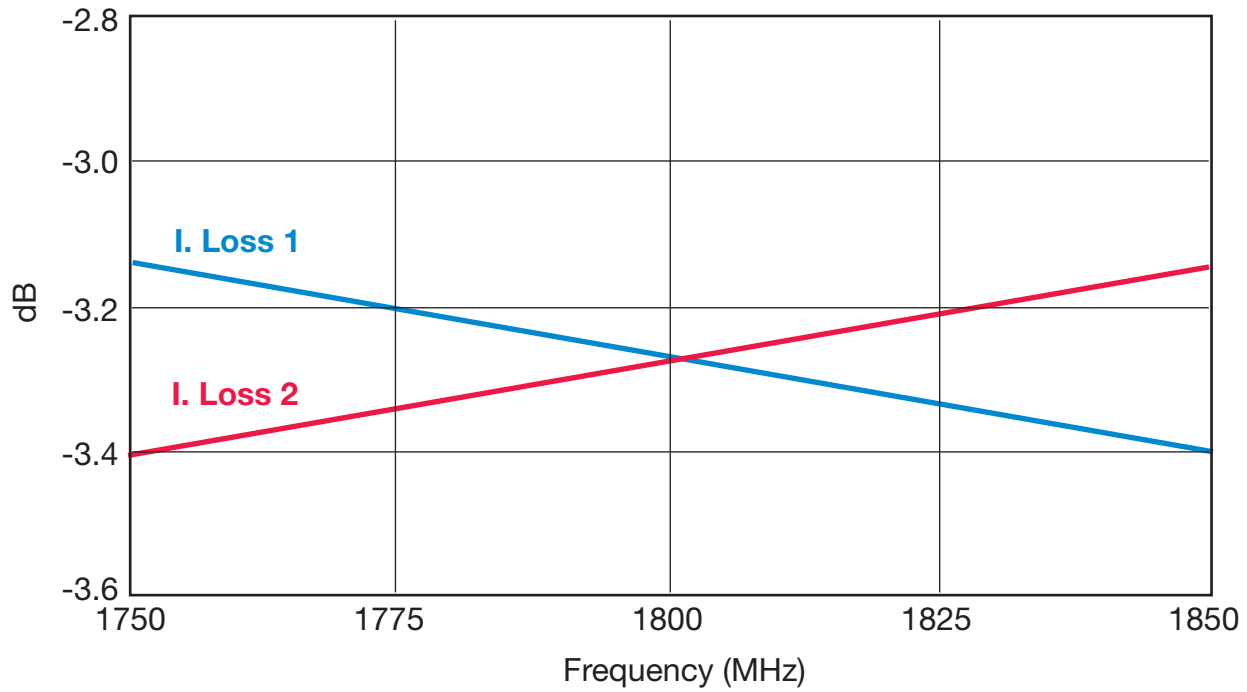

3

Thin-Film Directional Couplers

DB0805 3dB 90° Couplers



1850 ± 50MHz DB0805A1850ASTR

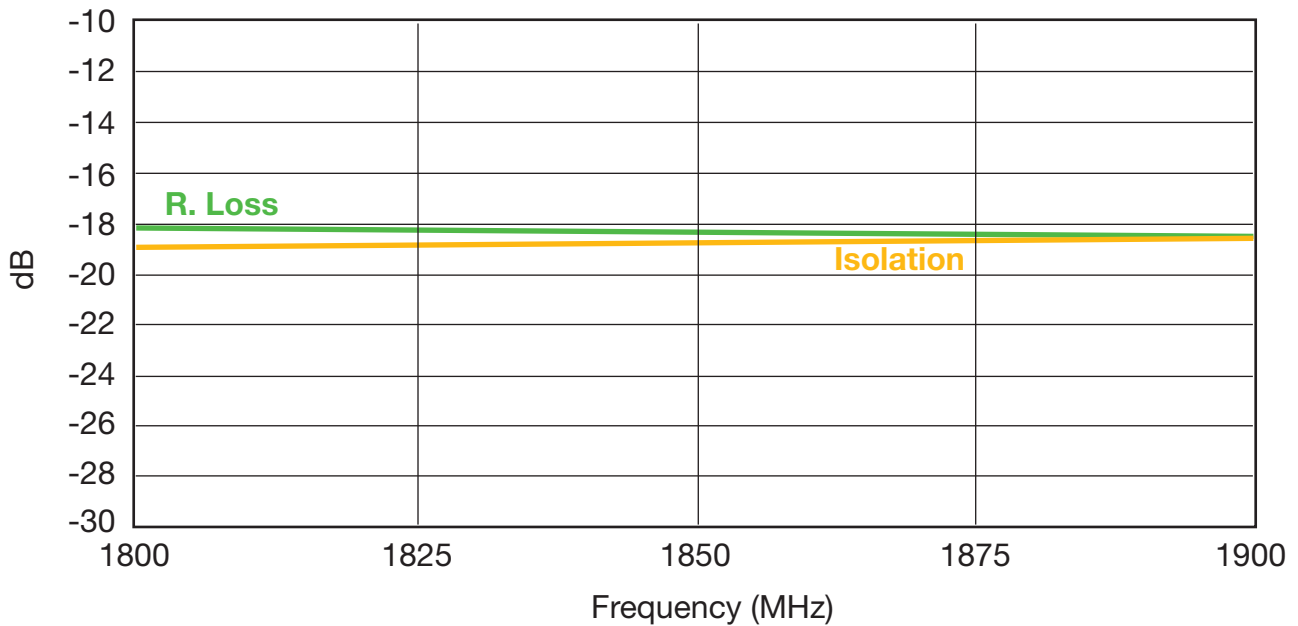
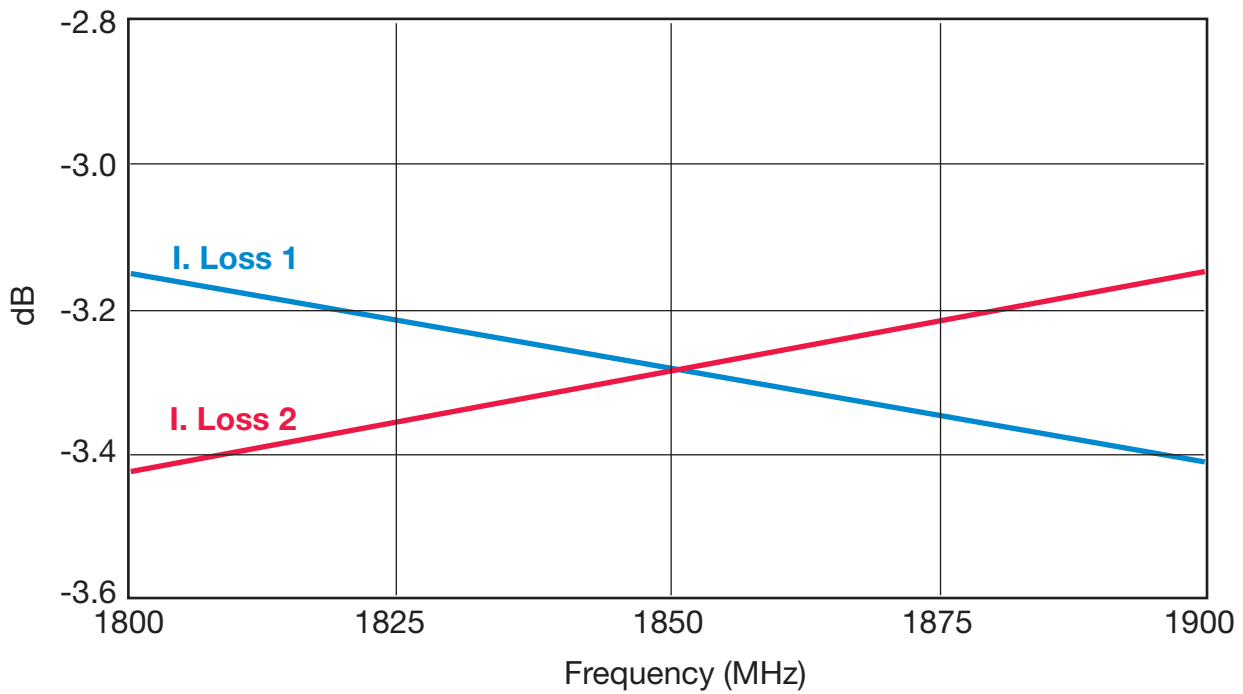

3



Thin-Film Directional Couplers

DB0805 3dB 90° Couplers



1900 ± 50MHz DB0805A1900ASTR

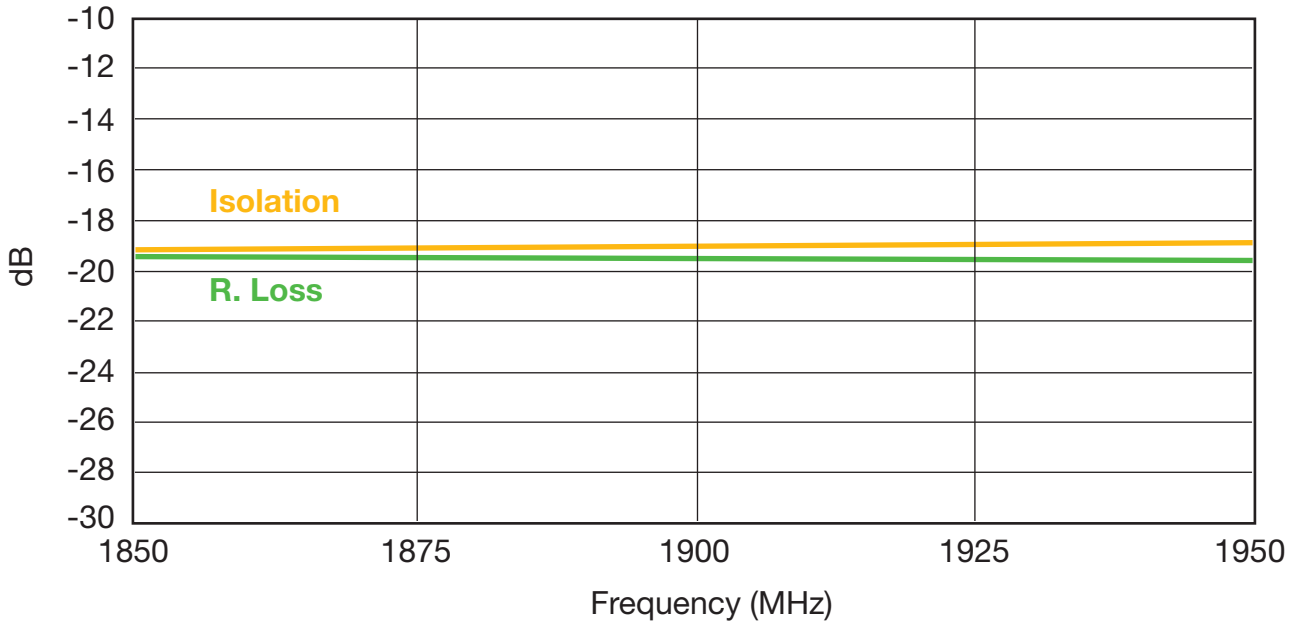
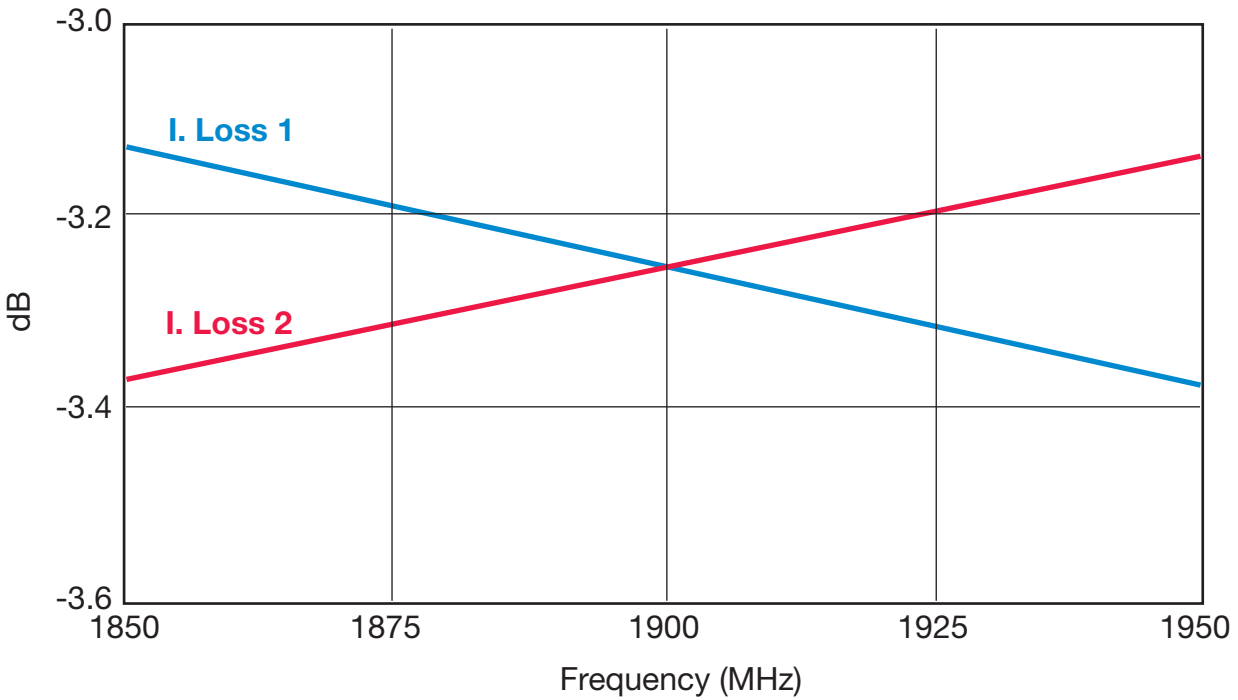

3

Thin-Film Directional Couplers

DB0805 3dB 90° Couplers



1950 ± 50MHz DB0805A1950ASTR

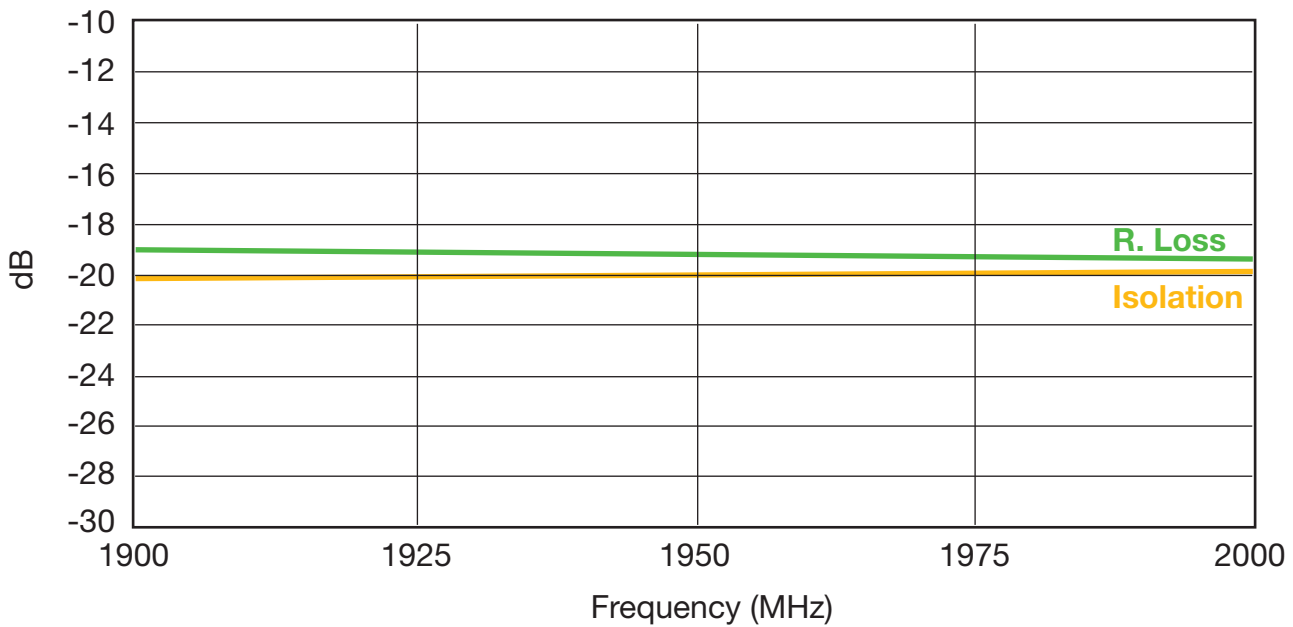
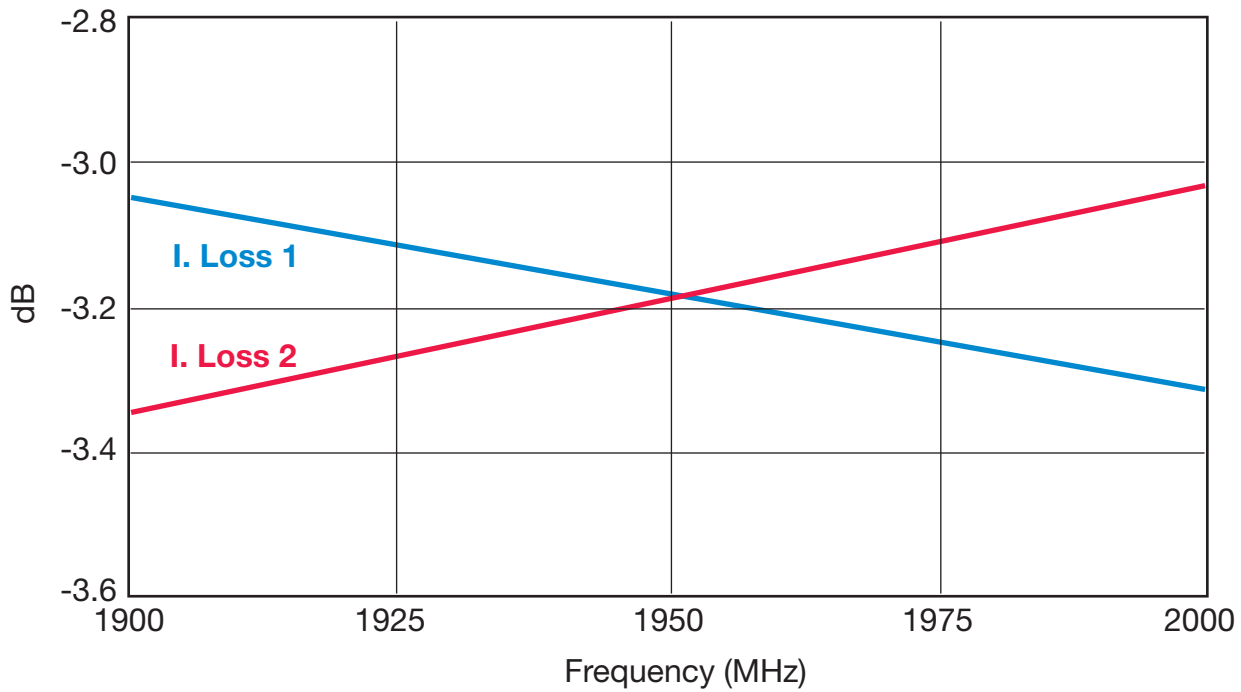

3



Thin-Film Directional Couplers

DB0805 3dB 90° Couplers



2140 ± 50MHz DB0805A2140ASTR

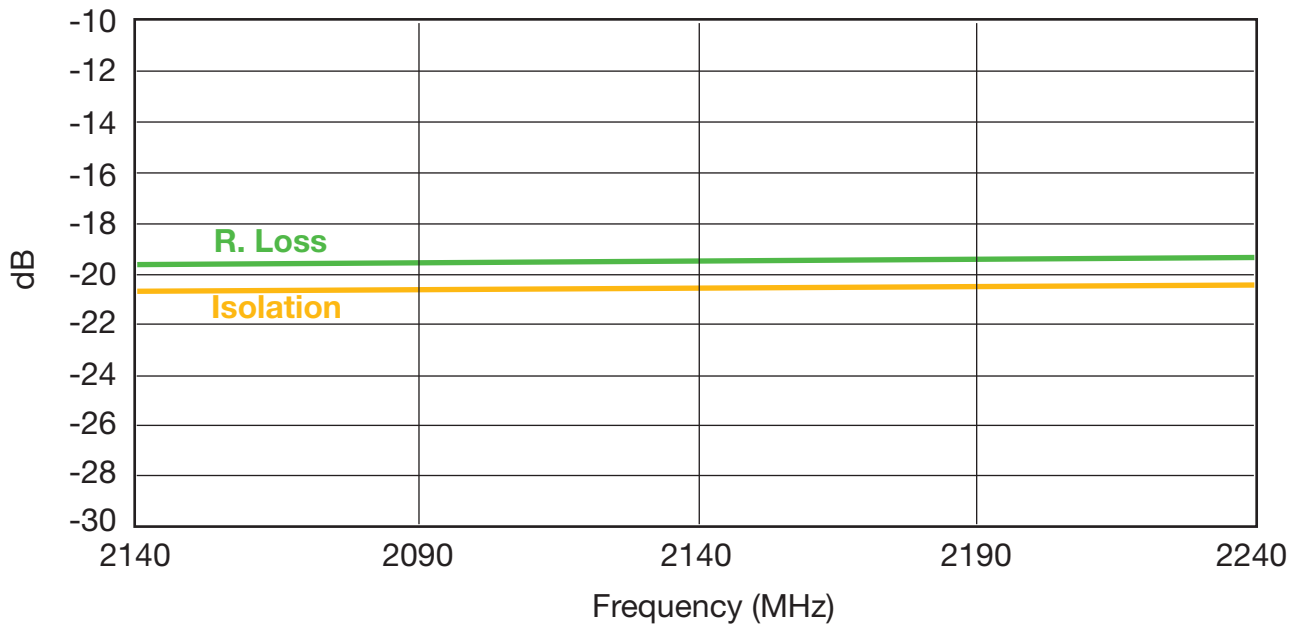
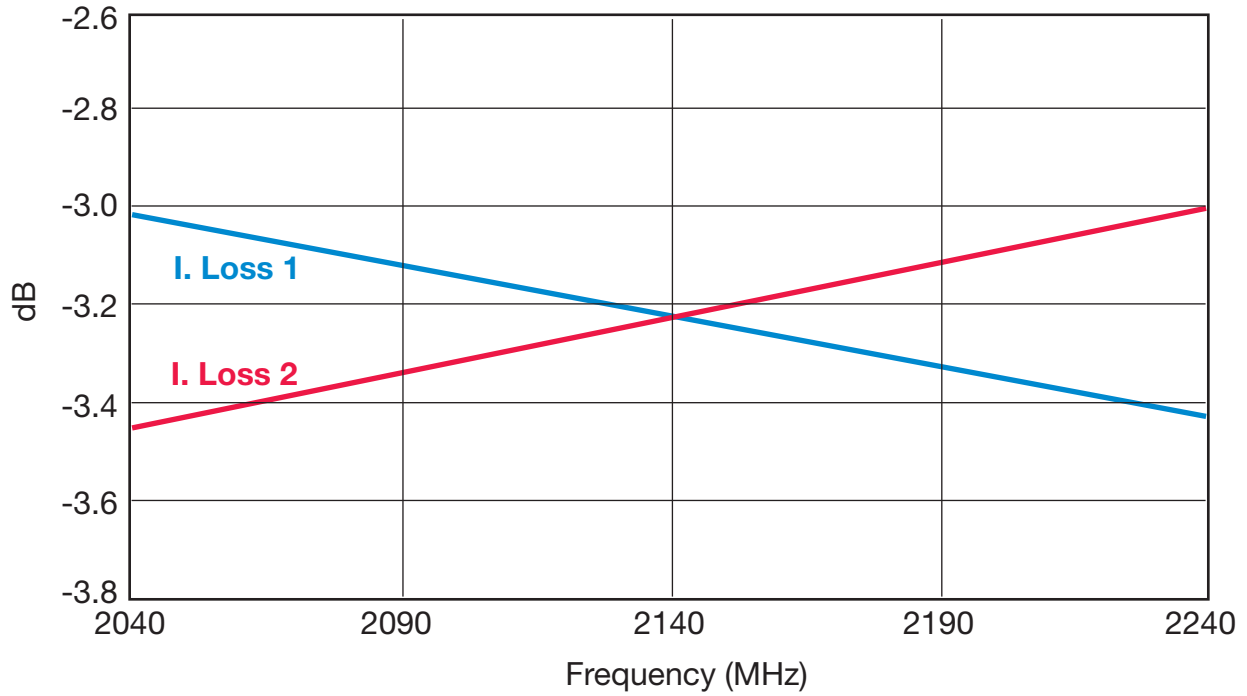

3

Thin-Film Directional Couplers

DB0805 3dB 90° Couplers



2325 ± 50MHz DB0805A2325ASTR

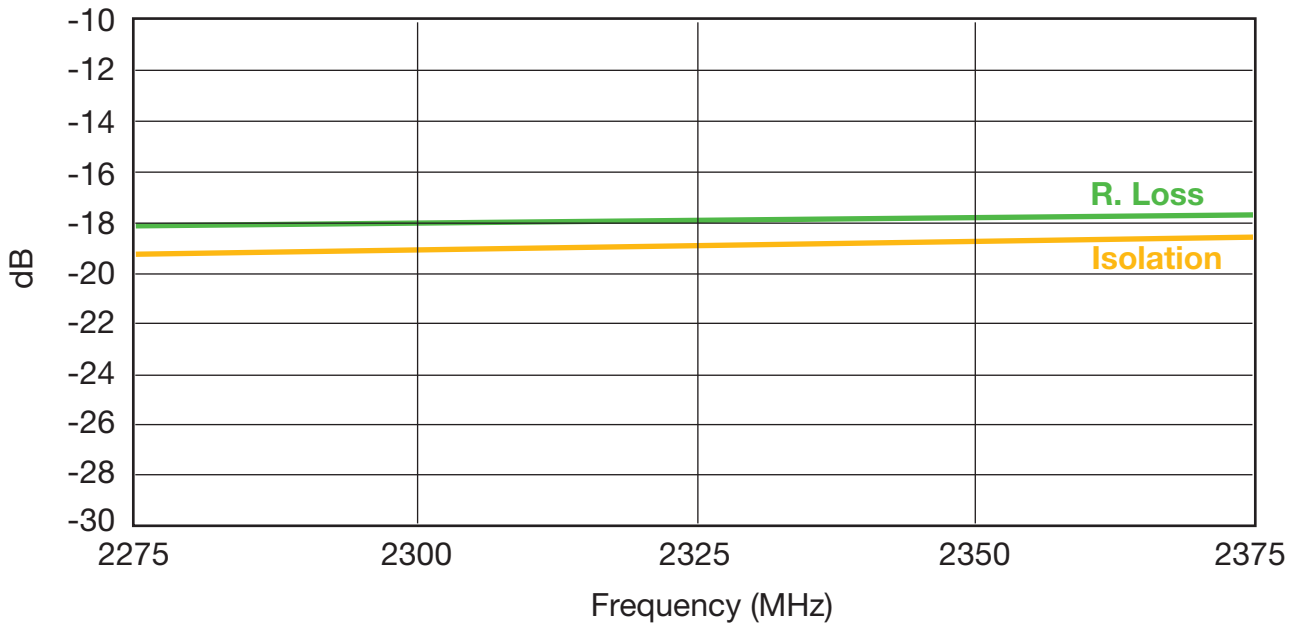
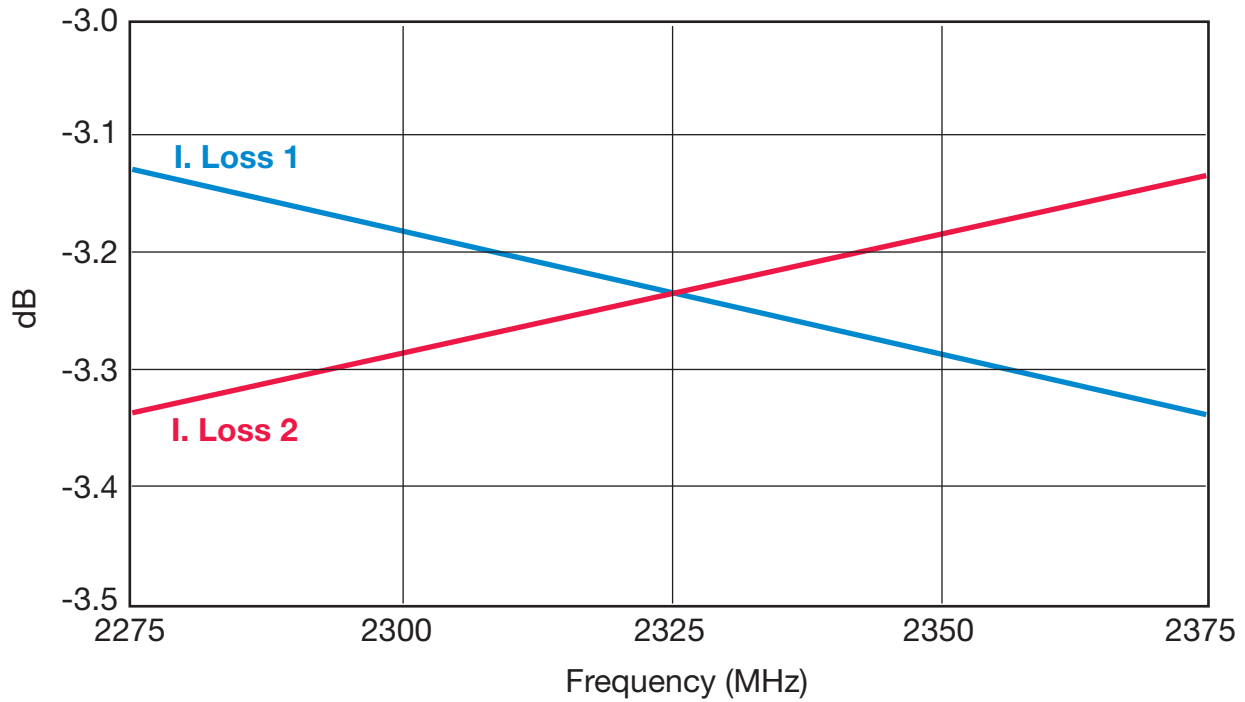

3



DB0805 3dB 90° Test Jigs

GENERAL DESCRIPTION

These jigs are designed for testing the DB0805 3dB 90° Couplers using a Vector Network Analyzer.

They consist of a dielectric substrate, having 50Ω microstrips as conducting lines and a bottom ground plane located at a distance of 0.254mm from the microstrips.

The substrate used is Neltec's NH9338ST0254C1BC.

The connectors are SMA type (female), 'Johnson Components Inc.' Product P/N: 142-0701-841.

Both a measurement jig and a calibration jig are provided.

The calibration jig is designed for a full 2-port calibration, and consists of an open line, short line and through line. LOAD calibration can be done by a 50Ω SMA termination.

MEASUREMENT PROCEDURE

When measuring a component, it can be either soldered or pressed using a non-metallic stick until all four ports touch the appropriate pads. Set the VNA to the relevant frequency band. Connect the VNA using a 10dB attenuator on the jig

terminal connected to port 2. Follow the VNA's instruction manual and use the [calibration jig](#) to perform a full 2-port calibration in the required bandwidths.

Place the coupler on the [measurement jig](#) as follows:

Input (Coupler) → Connector 1 (Jig) Output 1 (Coupler) → Connector 3 (Jig)
50Ω (Coupler) → Connector 2 (Jig) Output 2 (Coupler) → Connector 4 (Jig)

To measure [R. Loss](#) and [I. Loss 1](#) connect:

Connector 1 (Jig) → Port 1 (VNA) Connector 3 (Jig) → Port 2 (VNA)
Connector 2 (Jig) → 50Ω Connector 4 (Jig) → 50Ω

To measure [R. Loss](#) and [I. Loss 2](#) connect:

Connector 1 (Jig) → Port 1 (VNA) Connector 3 (Jig) → 50Ω
Connector 2 (Jig) → 50Ω Connector 4 (Jig) → Port 2 (VNA)

To measure [Isolation](#) connect:

Connector 1 (Jig) → 50Ω Connector 3 (Jig) → Port 1 (VNA)
Connector 2 (Jig) → 50Ω Connector 4 (Jig) → Port 2 (VNA)

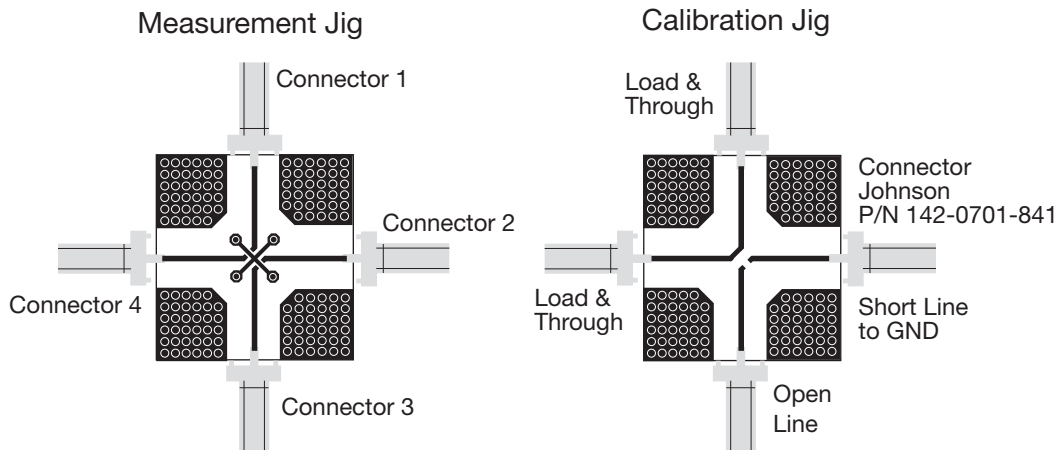



Thin-Film RF/Microwave Harmonic Low Pass Filter

LP0402/LP0603/LP0805

Thin-Film Low Pass Filter



LP0402N Series Harmonic Lead-Free LGA Termination

RFAP TECHNOLOGY

The LP0402N Series Harmonic Low Pass Filter is based on the proprietary RFAP Thin-Film multilayer technology. The technology provides a miniature part with excellent high frequency performance and rugged construction for reliable automatic assembly.

The RFAP Harmonic Low Pass Filter is offered in a variety of frequency bands compatible with various types of high frequency wireless systems.

APPLICATIONS

- Wireless communications
- Wireless LAN's
- GPS
- WiMAX

LAND GRID ARRAY ADVANTAGES

- Inherent Low Profile
- Self Alignment during Reflow
- Excellent Solderability
- Low Parasitics
- Better Heat Dissipation

HOW TO ORDER

LP
T
Style

0402
T
Size

N
T
Type

XXXX
T
Frequency
MHz

X
T
Sub-Type

N
T
Termination
LGA
Lead Free

TR
T
Taped & Reeled

QUALITY INSPECTION

Finished parts are 100% tested for electrical parameters and visual characteristics. Each production lot is evaluated on a sample basis for:

- Static Humidity: 85°C, 85% RH, 160 hours
- Endurance: 125°C, IR, 4 hours

TERMINATION

Nickel/Lead-Free solder coating compatible with automatic soldering technologies: reflow, wave soldering, vapor phase and manual.



Thin-Film Low Pass Filter



LP0402N Series Harmonic Lead-Free LGA Termination

DIMENSIONS: millimeters (inches) (Bottom View)

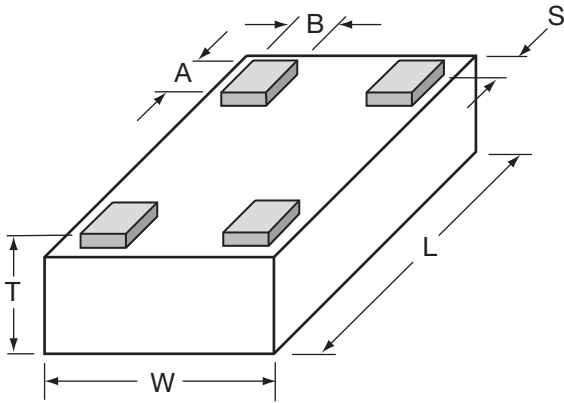

| | | | |
|---|----------------------------|---|----------------------------|
| L | 1.0±0.05 (0.040±0.002) | A | 0.20±0.06 (0.008±0.002) |
| W | 0.58±0.04 (0.023±0.002) | B | 0.18±0.05 (0.007±0.002) |
| T | 0.35±0.5 (0.014±0.002) | S | 0.05±0.05 (0.002±0.002) |

TERMINALS (Top View)

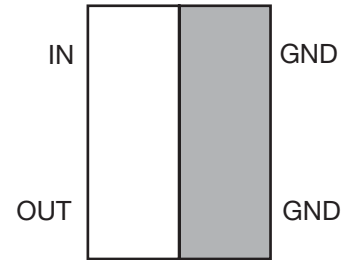

RECOMMENDED PAD LAYOUT (mm)

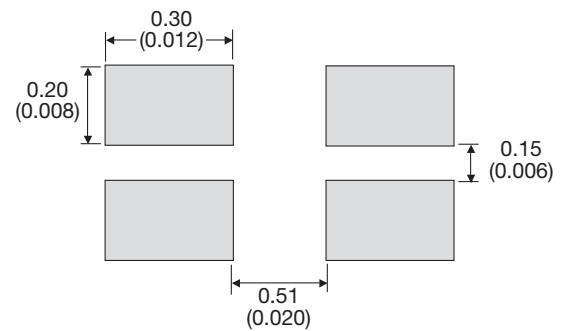

ELECTRICAL CHARACTERISTICS

(Guaranteed over -40°C to $+85^{\circ}\text{C}$ Operating Temperature Range)

| P/N | Frequency Band [MHz] | I. Loss [dB] | R. Loss [dB] | Attenuation @ $2x F_0$ [dB] | Attenuation @ $3x F_0$ [dB] |
|-----------------|----------------------|---------------------|--------------|-----------------------------|-----------------------------|
| LP0402N2442ANTR | 2400-2484 | 0.35 typ 0.5 max | 20 | 30 | 17 |
| LP0402N2690ANTR | 2640-2740 | 0.35 typ 0.5 max | 20 | 30 | 20 |
| LP0402N3500ANTR | 3400-3600 | 0.3 typ 0.5 max | 19 | 30 | 20 |
| LP0402N5200ANTR | 5500-5350 | 0.2 typ 0.5 max | 19 | 30 | 20 |
| LP0402N5500ANTR | 5350-5650 | 0.2 typ 0.5 max | 15 | 30 | - |
| LP0402N5800ANTR | 5600-6000 | 0.2 typ 0.5 max | 16 | 25 | - |

NOTE: Additional Frequencies Available Upon Request



Thin-Film Low Pass Filter



LP0402N Series Harmonic Lead-Free LGA Termination

LP0402N2442ANTR

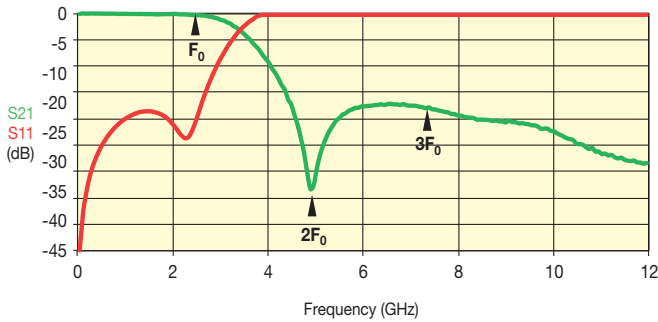

LP0402N5800ANTR

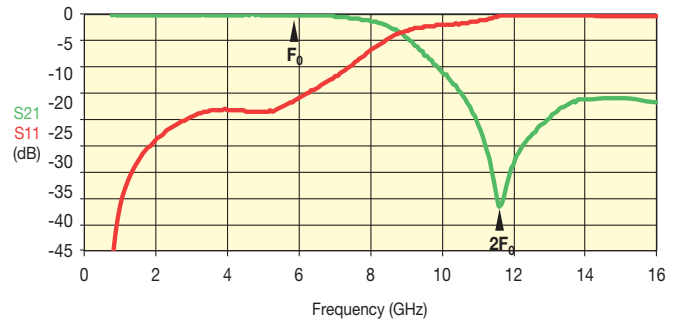

LP0402N2690ANTR

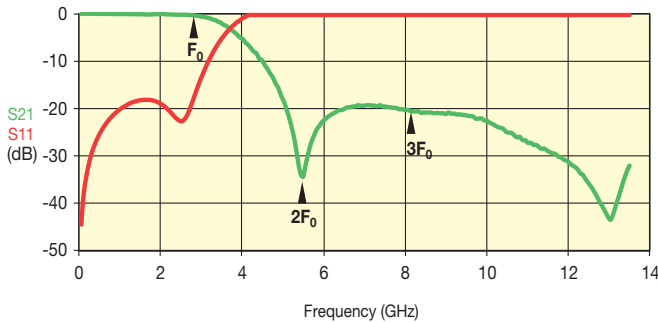

LP0402N3500ANTR

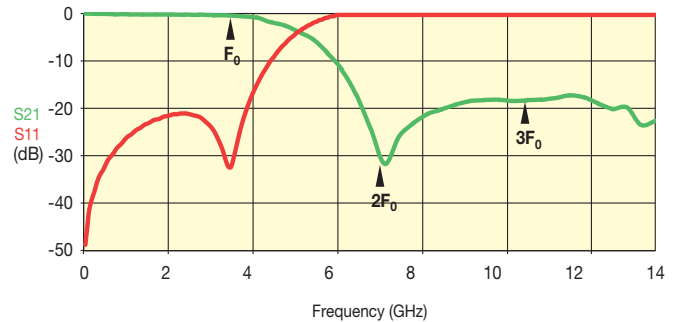

LP0402N5500ANTR

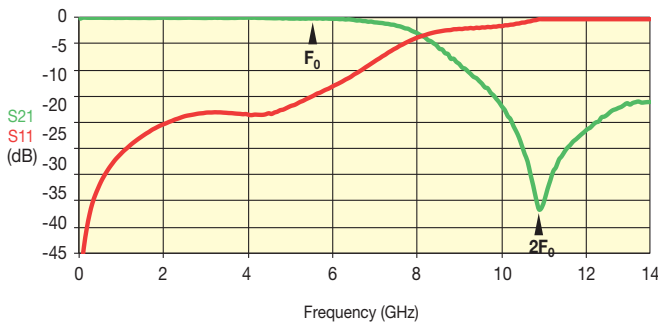

LP0402N5200ANTR

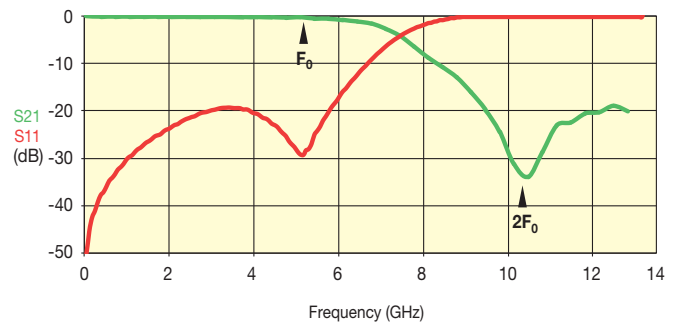

4

Thin-Film Low Pass Filter



LP0402N Series Harmonic Lead-Free LGA Termination Test Jig

TEST JIG FOR LP0402 LOW PASS FILTER

GENERAL DESCRIPTION

These jigs are designed for testing the LP0603 LGA Low Pass Filters using a Vector Network Analyzer.

They consist of a dielectric substrate, having 50Ω microstrips as conducting lines and a bottom ground plane located at a distance of 0.127mm from the microstrips.

The substrate used is Neltec's NH9338ST0127C1BC (or similar).

The connectors are SMA type (female), 'Johnson Components Inc.' Product P/N: 142-0701-841 (or similar).

Both a measurement jig and a calibration jig are provided.

The calibration jig is designed for a full 2-port calibration, and consists of an open line, short line and through line. LOAD calibration can be done by a 50Ω SMA termination.

MEASUREMENT PROCEDURE

Follow the VNA's instruction manual and use the [calibration jig](#) to perform a full 2-Port calibration in the required bandwidths.

Solder the filter to the [measurement jig](#) as follows:

- | | | | |
|-----------------|---------------------|--------------|-------------|
| Input (Filter) | ➔ Connector 1 (Jig) | GND (Filter) | ➔ GND (Jig) |
| Output (Filter) | ➔ Connector 2 (Jig) | GND (Filter) | ➔ GND (Jig) |

Set the VNA to the relevant frequency band. Connect the VNA using a 10dB attenuator on the jig terminal connected to port 2 (using an RF cable).

Measurement

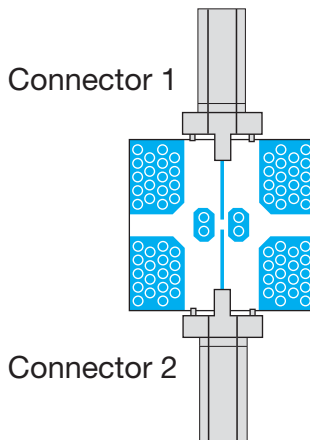

Calibration Jig

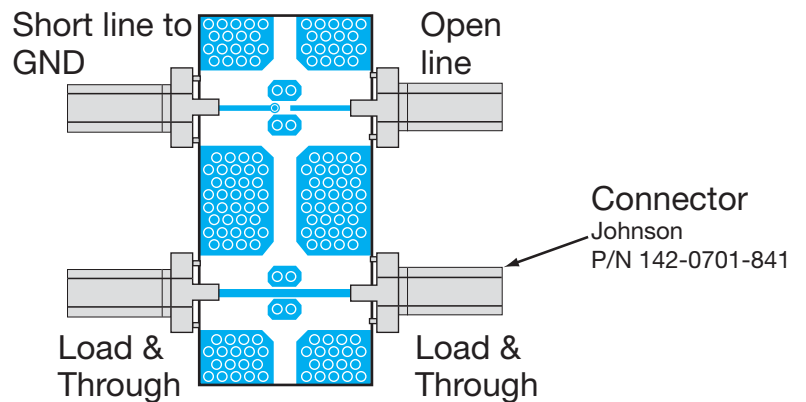

4

Thin-Film Low Pass Filter



LP0603 Lead-Free LGA Type

GENERAL DESCRIPTION

The LP0603 ITF (Integrated Thin Film) Lead-Free LGA Low Pass Filter is based on thin-film multilayer technology. The technology provides a miniature part with excellent high frequency performance and rugged construction for reliable automatic assembly.

The ITF Low Pass Filters are offered in a variety of frequency bands compatible with various types of high frequency wireless systems.

FEATURES

- Miniature Size: 0603
- Frequency Range: 900MHz-5.5GHz
- Characteristic Impedance: 50 Ohm
- Operating/Storage Temperature: -40°C to +85°C
- Power Rating: 3W Continuous
- Low Profile
- Rugged Construction
- Lead Free
- Taped and Reeled

APPLICATIONS

- Mobile communications
- Satellite TV receivers
- GPS
- Vehicle location systems
- Wireless LANs
- RFID

LAND GRID ARRAY ADVANTAGES

- Inherent Low Profile
- Self Alignment during Reflow
- Excellent Solderability
- Low Parasitics
- Better Heat Dissipation

HOW TO ORDER

LP
T
Style

0603
T
Size
0603

A
T
Type
A or N

XXXX
T
Frequency
MHz

A
T
Sub-Type

N
T
Termination
LGA
**Ni/Lead Free Solder

TR
T
Taped & Reeled

**RoHS compliant

FINAL QUALITY INSPECTION

Finished parts are 100% tested for electrical parameters and visual characteristics. Each production lot is evaluated on a sample basis for:

- Static Humidity: 85°C, 85% RH, 160 hours
- Endurance: 125°C, IR, 4 hours

TERMINATION

Nickel/Lead-Free Solder coating compatible with automatic soldering technologies: reflow, wave soldering, vapor phase and manual.



Thin-Film Low Pass Filter



LP0603 Lead-Free LGA Type

DIMENSIONS: millimeters (inches) (Bottom View)

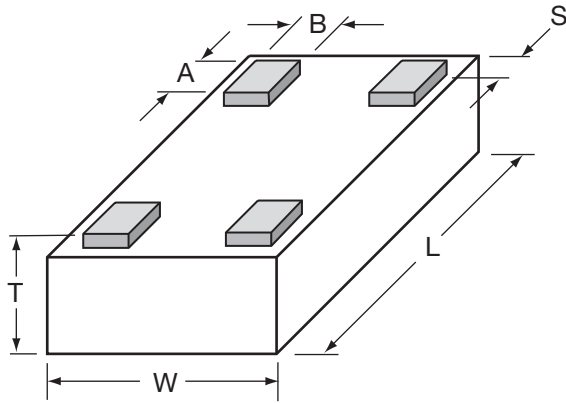

| | | | |
|---|---------------------------|---|----------------------------|
| L | 1.6±0.1 (0.063±0.004) | A | 0.25±0.05 (0.010±0.002) |
| W | 0.84±0.1 (0.033±0.004) | B | 0.20±0.05 (0.008±0.002) |
| T | 0.60±0.1 (0.024±0.004) | S | 0.05±0.05 (0.002±0.002) |

TERMINALS AND ORIENTATION IN TAPE (Top View)

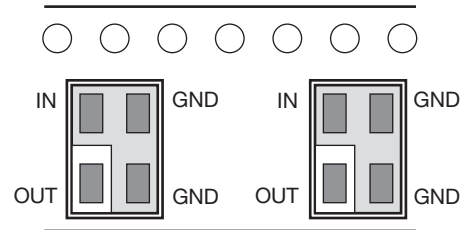

RECOMMENDED PAD LAYOUT (mm)

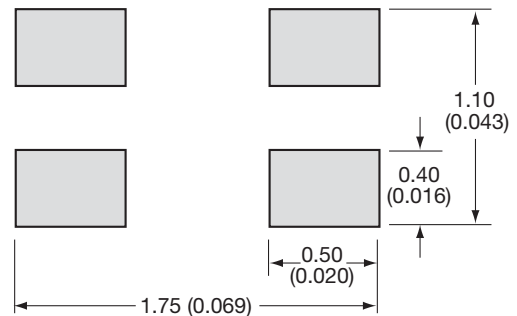

ELECTRICAL CHARACTERISTICS

(Guaranteed over -40°C to +85°C Operating Temperature Range)

| P/N | Frequency Band [MHz] | I. Loss [dB] | VSWR max [dB] | Attenuation typ. [dB] |
|-----------------|----------------------|------------------------|---------------|--|
| LP0603A0902ANTR | 890-915 | 0.35 typ (0.5 max) | 1.4 | 25 @ 2xF ₀ 14 @ 3xF ₀ |
| LP0603A0947ANTR | 935-960 | 0.35 typ (0.5 max) | 1.4 | 25 @ 2xF ₀ 17 @ 3xF ₀ |
| LP0603A1747ANTR | 1710-1785 | 0.3 typ (0.5 max) | 1.4 | 25 @ 2xF ₀ 17 @ 3xF ₀ |
| LP0603A1842ANTR | 1805-1880 | 0.3 typ (0.5 max) | 1.4 | 27 @ 2xF ₀ 15 @ 3xF ₀ |
| LP0603A1880ANTR | 1840-1920 | 0.3 typ (0.5 max) | 1.4 | 25 @ 2xF ₀ 17 @ 3xF ₀ |
| LP0603A1950ANTR | 1920-1980 | 0.3 typ (0.5 max) | 1.4 | 27 @ 2xF ₀ 15 @ 3xF ₀ |
| LP0603A2140ANTR | 2110-2170 | 0.3 typ (0.5 max) | 1.4 | 27 @ 2xF ₀ 17 @ 3xF ₀ |
| LP0603A2442ANTR | 2412-2472 | 0.3 typ (0.5 max) | 1.4 | 25 @ 2xF ₀ 17 @ 3xF ₀ |
| LP0603N3500ANTR | 3400-3600 | -0.3 typ. -0.5 max. | 1.4 | 30 @ 2xF ₀ 20 @ 3xF ₀ |
| LP0603N5200ANTR | 5050-5350 | -0.2 typ. -0.5 max. | 1.4 | 30 @ 2xF ₀ 20 @ 3xF ₀ |
| LP0603N5500ANTR | 5350-5650 | -0.2 typ. -0.5 max. | 1.4 | 30 @ 2xF ₀ 20 @ 3xF ₀ |

NOTE: Additional Frequencies Available Upon Request

Thin-Film Low Pass Filter

LP0603 Lead-Free LGA Type

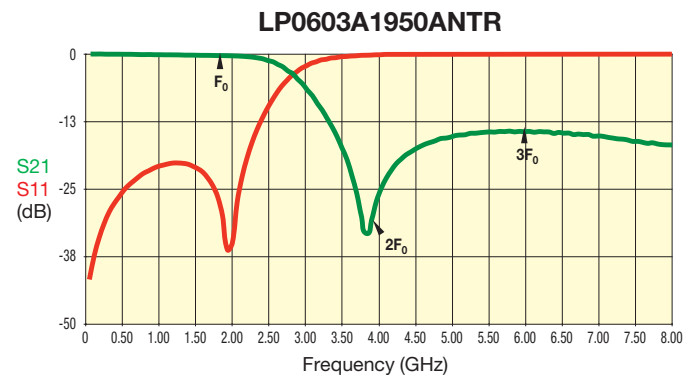
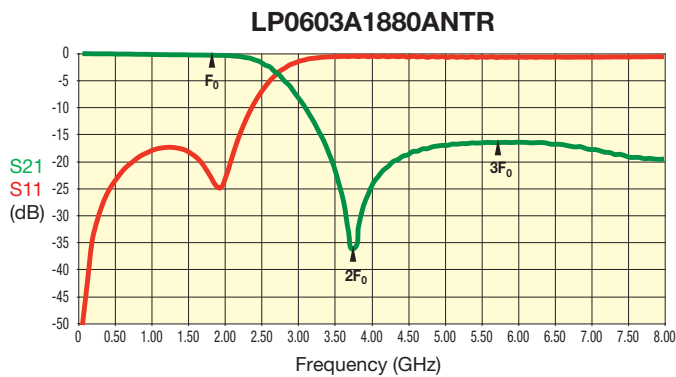
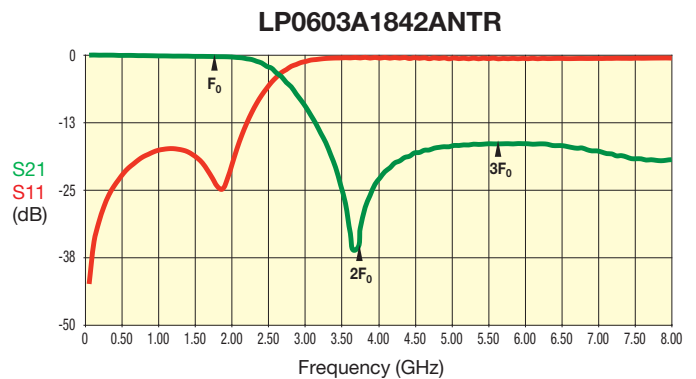
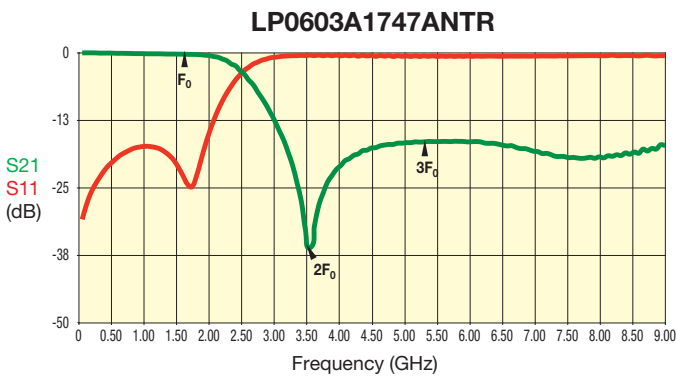
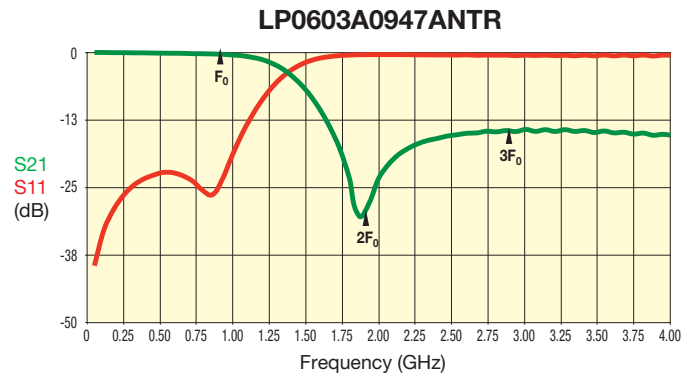
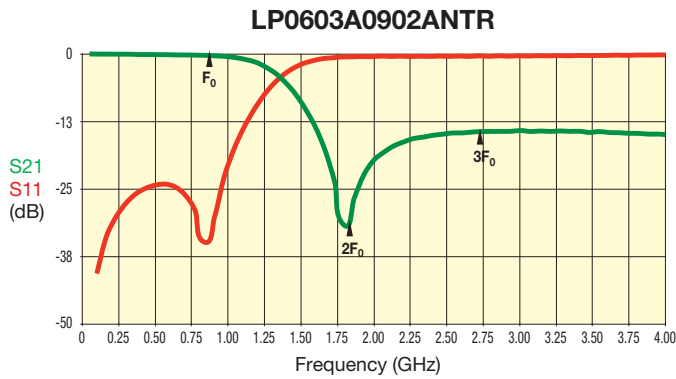

4

Thin-Film Low Pass Filter

LP0603 Lead-Free LGA Type



LP0603A2140ANTR

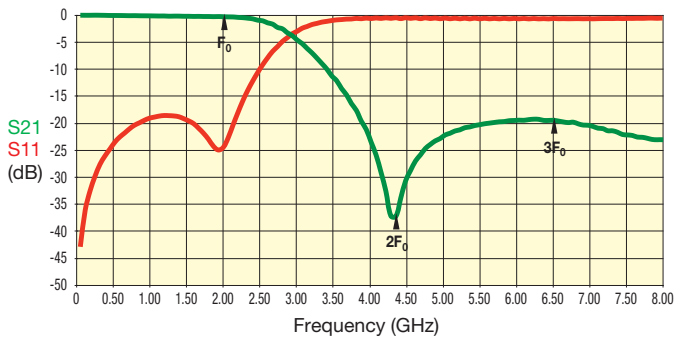

LP0603A2442ANTR

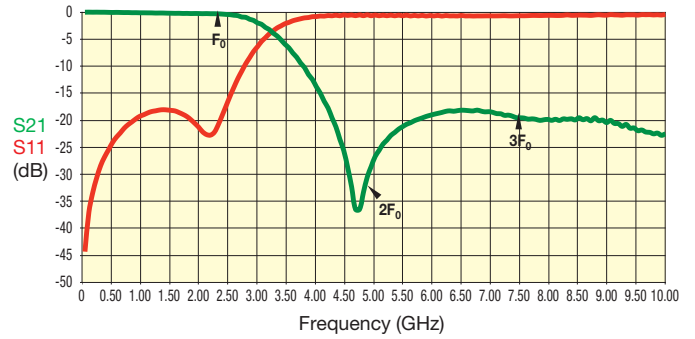

LP0603N3500ANTR

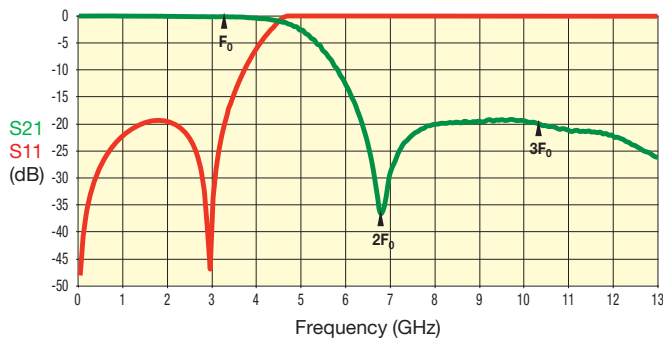

LP0603N5200ANTR

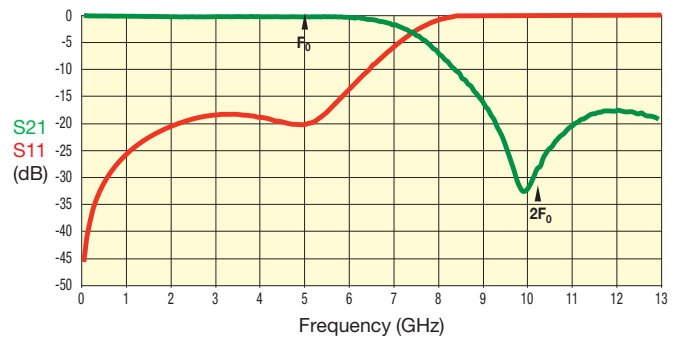

LP0603N5500ANTR

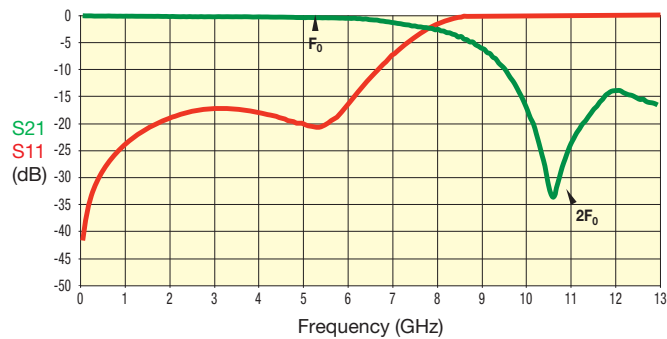

4

Thin-Film Low Pass Filter

LP0603 Lead-Free LGA Type Test Jig

TEST JIG FOR LP0603 LEAD-FREE LGA LOW PASS FILTER

GENERAL DESCRIPTION

These jigs are designed for testing the LP0603 LGA Low Pass Filters using a Vector Network Analyzer.

They consist of a dielectric substrate, having 50Ω microstrips as conducting lines and a bottom ground plane located at a distance of 0.127mm from the microstrips.

The substrate used is Neltec's NH9338ST0127C1BC (or similar).

The connectors are SMA type (female), 'Johnson Components Inc.' Product P/N: 142-0701-841 (or similar).

Both a measurement jig and a calibration jig are provided.

The calibration jig is designed for a full 2-port calibration, and consists of an open line, short line and through line. LOAD calibration can be done by a 50Ω SMA termination.

MEASUREMENT PROCEDURE

Follow the VNA's instruction manual and use the [calibration jig](#) to perform a full 2-Port calibration in the required bandwidths.

Solder the filter to the [measurement jig](#) as follows:

- | | | | |
|-----------------|---------------------|--------------|-------------|
| Input (Filter) | ➔ Connector 1 (Jig) | GND (Filter) | ➔ GND (Jig) |
| Output (Filter) | ➔ Connector 2 (Jig) | GND (Filter) | ➔ GND (Jig) |

Set the VNA to the relevant frequency band. Connect the VNA using a 10dB attenuator on the jig terminal connected to port 2 (using an RF cable).

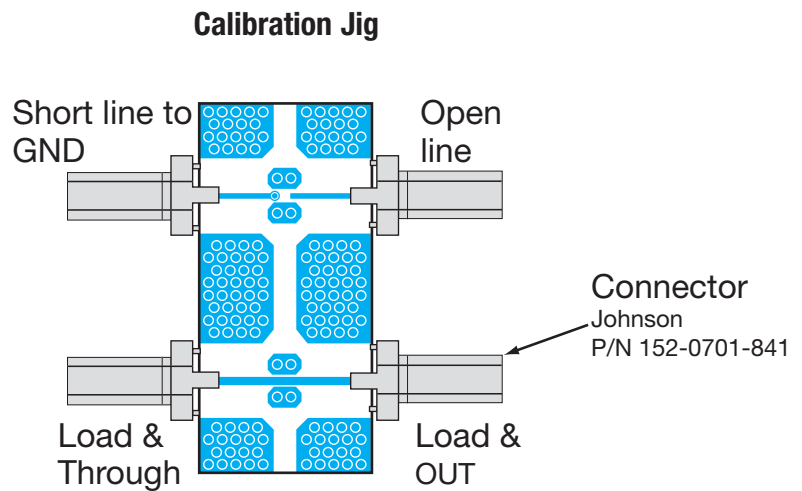
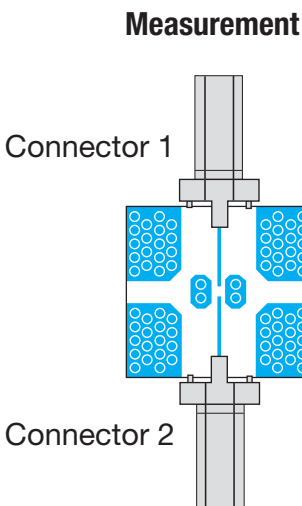

Thin-Film Low Pass Filter



LP0805 Type Harmonic

GENERAL DESCRIPTION

The ITF (Integrated Thin-Film) SMD Filter is based on thin-film multilayer technology. The technology provides a miniature part with excellent high frequency performance and rugged construction for reliable automatic assembly.

The ITF Filter is offered in a variety of frequency bands compatible with various types of high frequency wireless systems.

FEATURES

- Small Size: 0805
- Frequency Range: 800MHz - 3.5GHz
- Characteristic Impedance: 50Ω
- Operating / Storage Temp.: -40°C to +85°C
- Power Rating: 3W Continuous
- Low Profile
- Rugged Construction
- Taped and Reeled

APPLICATIONS

- Mobile Communications
- Satellite TV Receivers
- GPS
- Vehicle Location Systems
- Wireless LAN's

DIMENSIONS: millimeters (inches)

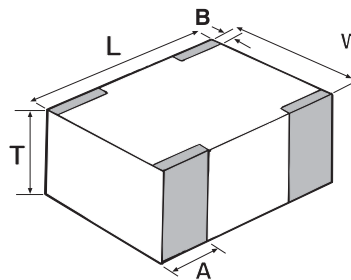

| | |
|---|----------------------------|
| L | 2.03±0.1 (0.080±0.004) |
| W | 1.55±0.1 (0.061±0.004) |
| T | 1.02±0.1 (0.040±0.004) |
| A | 0.56±0.25 (0.022±0.010) |
| B | 0.35±0.15 (0.014±0.006) |

PAD LAYOUT

See CP0805 pad layout on page 64.

FINAL QUALITY INSPECTION

Finished parts are 100% tested for electrical parameters and visual/mechanical characteristics. Each production lot is evaluated on a sample basis for:

- Static Humidity: 85°C, 85% RH, 160 hours
- Endurance: 125°C, I_R 4 hours

TERMINATION

Nickel/Solder coating (Sn, Pb) compatible with automatic soldering technologies: reflow, wave soldering, vapor phase and manual.

HOW TO ORDER

LP
T
Style
Low Pass

0805A
T
Size
0805

0902
T
Frequency
MHz

AW
T
Termination
AW= Nickel/Solder (SnPb)
**AS = Nickel/ Lead Free
Solder (Sn100)

TR
T
Packaging Code
TR = Tape and Reel

**RoHS compliant

Not RoHS Compliant



TERMINALS AND LAYOUT (Top View)

Orientation in Tape

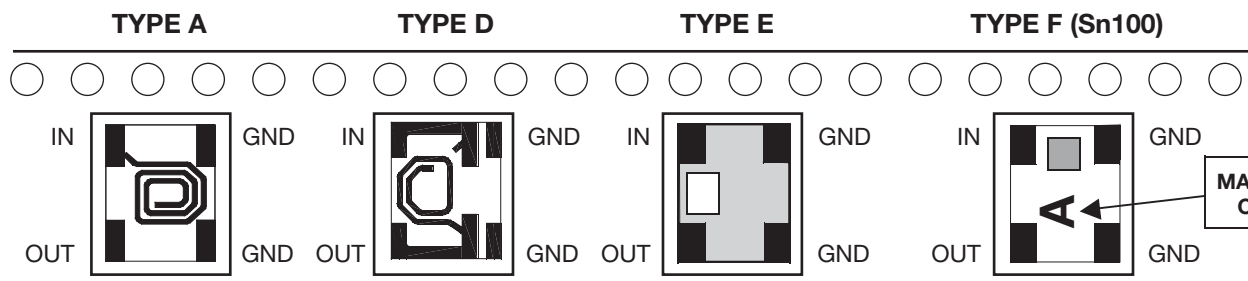

For RoHS compliant products,
please select correct termination style.

Thin-Film Low Pass Filter



LP0805 Type Harmonic

ELECTRICAL CHARACTERISTICS

| Application | Part Number | Frequency Band (MHz) | I. Loss max | VSWR max | Attenuation (dB) Typical | Layout Type (SnPb) | Layout Type F Marking Code |
|---------------|---------------|----------------------|----------------------|----------|--------------------------------|--------------------|----------------------------|
| E-GSM | LP0805A0897AS | 880 - 915 | 0.4dB (0.3dB typ) | 1.7 | 30 @ 2X F_o 20 @ 3X F_o | A | E |
| | LP0805A0942AS | 925 - 960 | | | | A | F |
| GSM | LP0805A0902AS | 890 - 915 | | | | A | E |
| | LP0805A0947AS | 935 - 960 | | | | A | F |
| LP0805A1119AS | 1101 - 1137 | A | | | | H | |
| | LP0805A0836AS | 824 - 849 | | | | A | A |
| AMPS | LP0805A0881AS | 869 - 894 | | | | A | C |
| | LP0805A1747AS | 1710 - 1785 | | | | D | I |
| PCN | LP0805A1842AS | 1805 - 1880 | | | | D | J |
| | LP0805A1880AS | 1850 - 1910 | | | | D | K |
| PCS | LP0805A1960AS | 1930 - 1990 | | | | D | M |
| | LP0805A1907AS | 1895 - 1920 | | | | D | L |
| PHP | LP0805A1890AS | 1880 - 1900 | | | | D | K |
| DECT | LP0805A1890AS | 1880 - 1900 | | | | D | K |
| 3G | LP0805A2150AS | 1905 - 2180 | | | | D | N |
| Wireless LAN | LP0805A2442AS | 2400 - 2484 | | | | D | S |
| WLL | LP0805A3500AS | 3400 ~ 3600 | E | X | | | |

Typical Electrical Performance

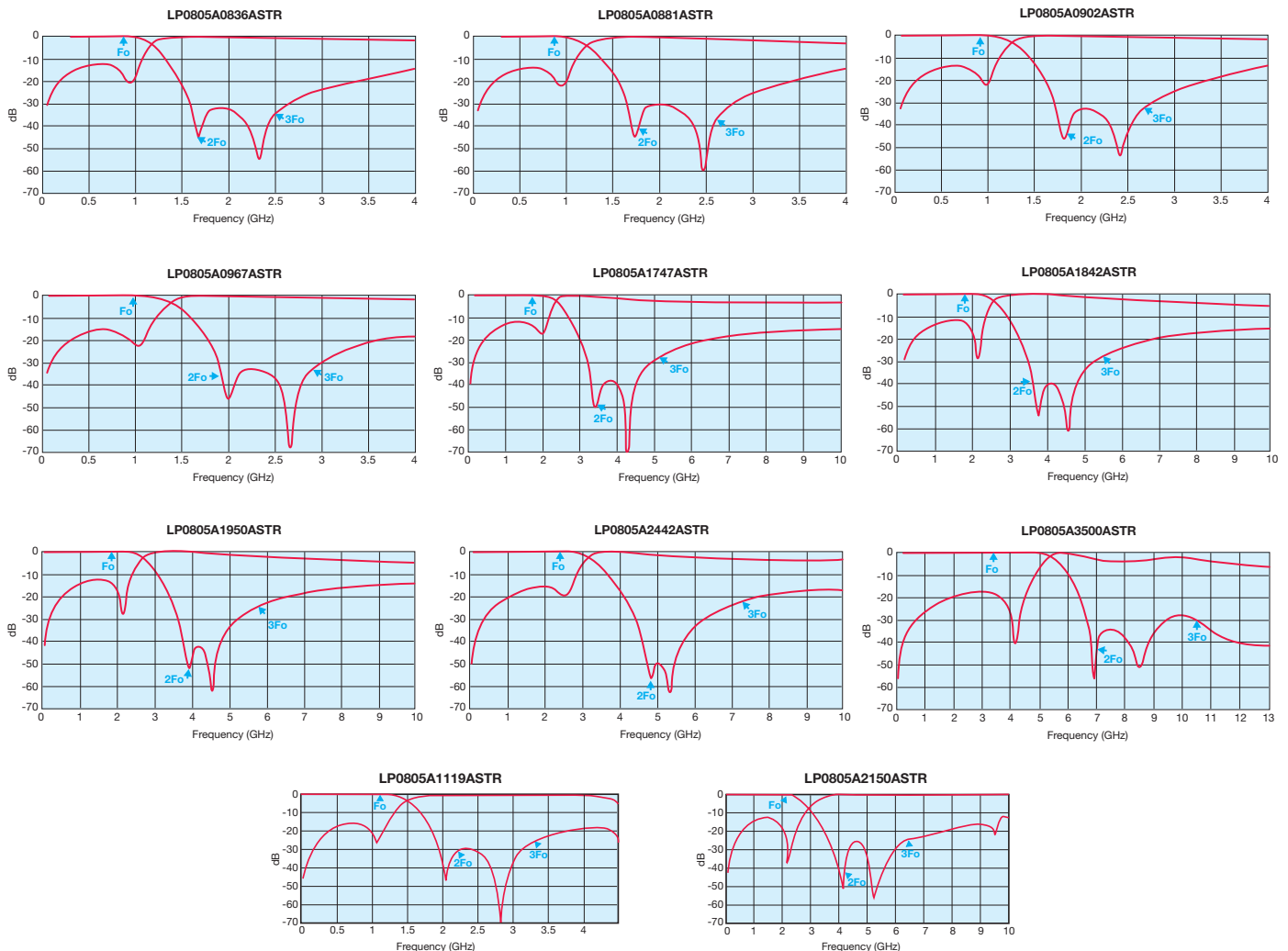

4

Thin-Film Low Pass Filter

LP0805 Test Jig

ITF TEST JIG FOR LOW PASS FILTER 0805

GENERAL DESCRIPTION

These jigs are designed for testing the LPF0805 Low Pass Filters using a Vector Network Analyzer.

They consist of a dielectric substrate, having 50W microstrips as conducting lines and a bottom ground plane located at a distance of 0.254 mm from the microstrips.

The substrate used is RF-35-0100-C1B107 (or similar).

The connectors are SMA type (female), 'Johnson Components Inc.' Product P/N: 142-0701-841(or similar).

Both a measurement jig and a calibration jig are provided.

The calibration jig is designed for a full 2-port calibration, and consists of an open line, short line and through line. LOAD calibration can be done by a 50W SMA termination.

MEASUREMENT PROCEDURE

Follow the VNA's instruction manual and use the [calibration jig](#) to perform a full 2-Port calibration in the required bandwidths.

Solder the filter to the [measurement jig](#) as follows:

Input (Filter) ➔ Connector 1 (Jig) GND (Filter) ➔ GND (Jig)

Output (Filter) ➔ Connector 2 (Jig) GND (Filter) ➔ GND (Jig)

Set the VNA to the relevant frequency band. Connect the VNA using a 10dB attenuator on the jig terminal connected to port 2 (using an RF cable).

Measurement

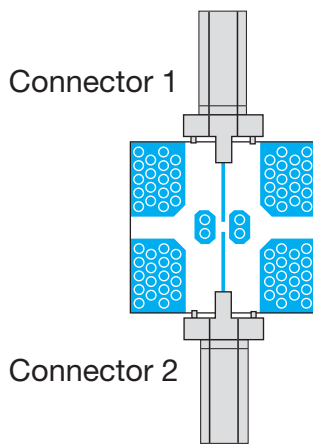

Calibration Jig

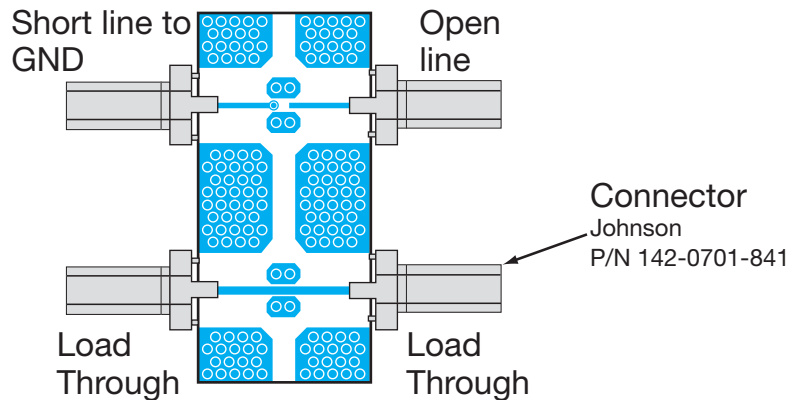

4

High Performance Harmonic Low Pass Filter



LP1206A0512BNTR



ITF TECHNOLOGY

The ITF LGA Filter is based on thin-film multilayer technology. The technology provides a miniature part with excellent high frequency performance and rugged construction for reliable automatic assembly. The ITF Filter is offered in a variety of frequency bands compatible with various types of high frequency wireless systems.

FEATURES

- Small size: 1206
- Frequency: 512MHz
- Characteristic impedance: 50Ω
- Operating/Storage temp: -40°C to +85°C
- Low profile
- Rugged construction
- Taped and reeled
- RoHS compliant

APPLICATIONS

- Mobile communications
- Satellite TV receivers
- GPS
- Vehicle location systems
- Wireless LAN's

HOW TO ORDER

LP 1206 **A** **XXXX** **B** **N** **TR**
 Type Frequency (MHz) Sub-Type Termination Taped & Reeled

FINAL QUALITY INSPECTION

Finished parts are 100% tested for electrical parameters and visual/mechanical characteristics. Each production lot is evaluated on a sample basis for:

- Static Humidity: 85°C, 85% RH, 160 hours
- Endurance: 125°C, I_B, 4 hours



TERMINATION

Nickel/ Lead free Solder coating (Sn100) compatible with automatic soldering technologies: reflow, wave soldering, vapor phase and manual.

POWER RATING

3W RF Continuous

ORIENTATION IN TAPE

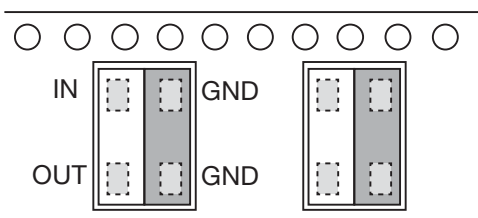

DIMENSIONS (Bottom View)

mm (inches)

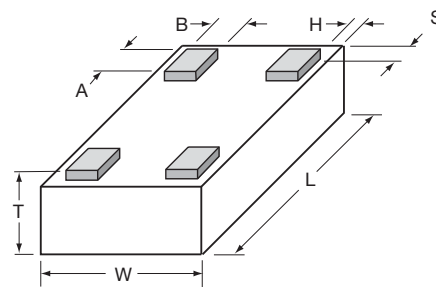

| | |
|------|----------------------------|
| L | 3.10±0.10 (0.122±0.004) |
| W | 1.60±0.10 (0.063±0.004) |
| T | 0.60±0.30 (0.024±0.012) |
| A | 0.39±0.10 0.015±0.004 |
| B | 0.33±0.10 0.013±0.004 |
| H, S | 0.05±0.05 (0.002±0.002) |

TERMINALS (Top View)

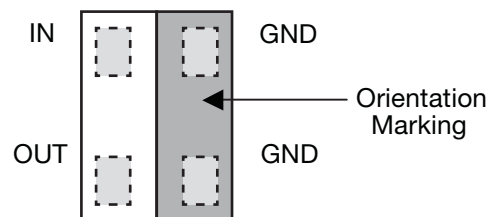

Recommended Pad Layout Dimensions mm (inches)

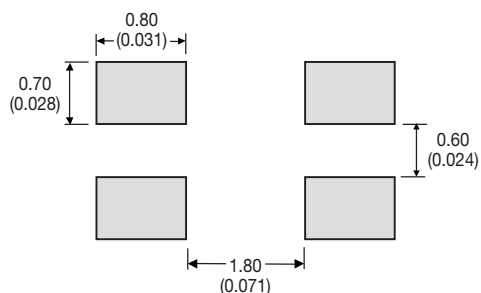

High Performance Harmonic Low Pass Filter



LP1206A0512BNTR

TERMINALS (Top View)

| Parameter | Value | Unit | Notes |
|--------------------|------------|------|-----------------------|
| Fc | 512 | MHz | |
| Rejection @ 900MHz | -35 | dB | Min. (720MHz to 2GHz) |
| Insertion Loss | 0.8 | dB | Max. |
| VSWR | 2.3: 1 | | Max. (all ports) |
| Power Handling | 3 | W | Continuous |
| Impedance | 50 | Ohm | |
| Operating Temp. | -40 to +85 | °C | |
| Size | 1206 | | |

TYPICAL ELECTRICAL PERFORMANCE

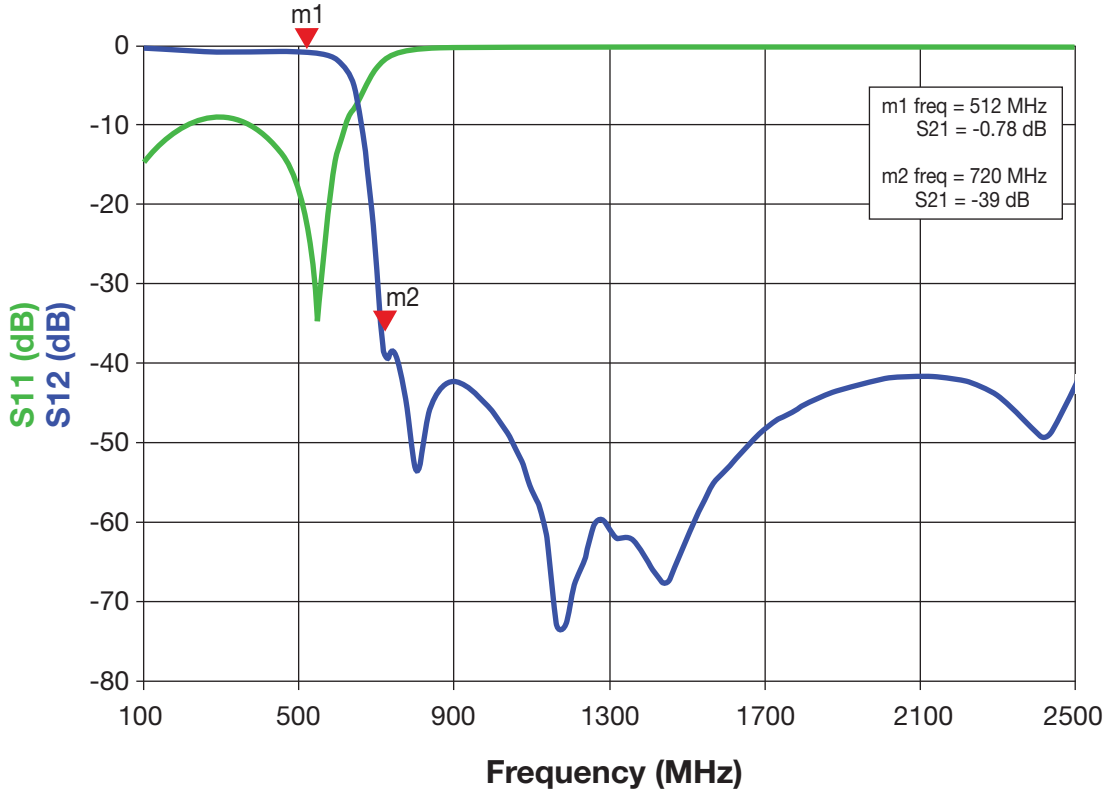

4



High Performance Low Pass Filter



LP1206A0700ANTR



HOW TO ORDER

LP 1206 **A** XXXX **A** **N** **TR**
 Type Frequency (MHz) Sub-Type Termination Taped & Reeled



FINAL QUALITY INSPECTION

Finished parts are 100% tested for electrical parameters and visual/mechanical characteristics. Each production lot is evaluated on a sample basis for:

- Static Humidity: 85°C, 85% RH, 160 hours
- Endurance: 125°C, I_B, 4 hours

TERMINATION

Nickel/ Lead free Solder coating (Sn100) compatible with automatic soldering technologies: reflow, wave soldering, vapor phase and manual.

POWER RATING

3W RF Continuous

ORIENTATION IN TAPE

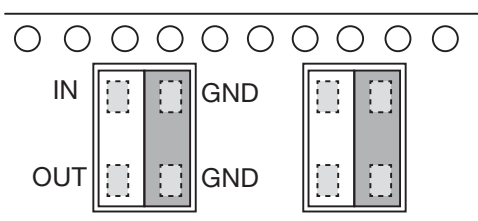

ITF TECHNOLOGY

The ITF LGA Filter is based on thin-film multilayer technology. The technology provides a miniature part with excellent high frequency performance and rugged construction for reliable automatic assembly. The ITF Filter is offered in a variety of frequency bands compatible with various types of high frequency wireless systems.

FEATURES

- Small size: 1206
- Frequency: 700MHz
- Characteristic impedance: 50Ω
- Operating/Storage temp: -40°C to +85°C
- Low profile
- Rugged construction
- Taped and reeled
- RoHS compliant

APPLICATIONS

- Mobile communications
- Satellite TV receivers
- GPS
- Vehicle location systems
- Wireless LAN's

DIMENSIONS (Bottom View)

mm (inches)

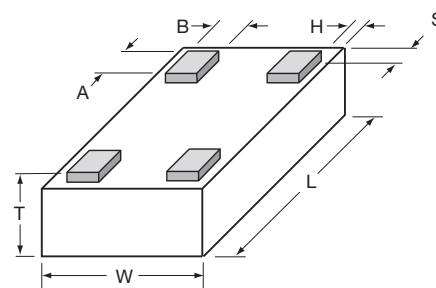

| | |
|------|----------------------------|
| L | 3.10±0.10 (0.122±0.004) |
| W | 1.60±0.10 (0.063±0.004) |
| T | 0.60±0.30 (0.024±0.012) |
| A | 0.39±0.10 0.015±0.004 |
| B | 0.33±0.10 0.013±0.004 |
| H, S | 0.05±0.05 (0.002±0.002) |

TERMINALS (Top View)

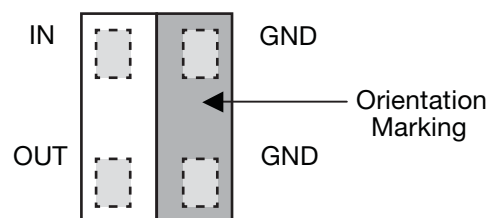

Recommended Pad Layout Dimensions mm (inches)

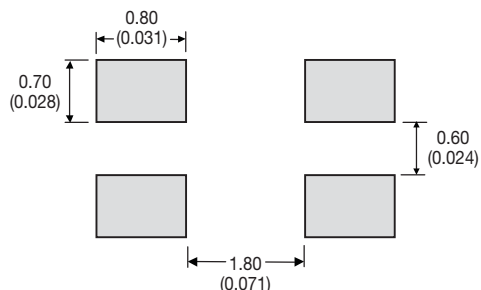

High Performance Low Pass Filter



LP1206A0700ANTR

TERMINALS (Top View)

| Parameter | Value | Unit | Notes |
|--------------------|------------|------|-----------------------|
| Fc | 700 | MHz | |
| Rejection @ 900MHz | -35 | dB | Min. (900MHz to 2GHz) |
| Insertion Loss | 0.9 | dB | Max. |
| VSWR | 2.3: 1 | | Max. (all ports) |
| Power Handling | 3 | W | Continuous |
| Impedance | 50 | Ohm | |
| Operating Temp. | -40 to +85 | °C | |
| Size | 1206 | | |

TYPICAL ELECTRICAL PERFORMANCE

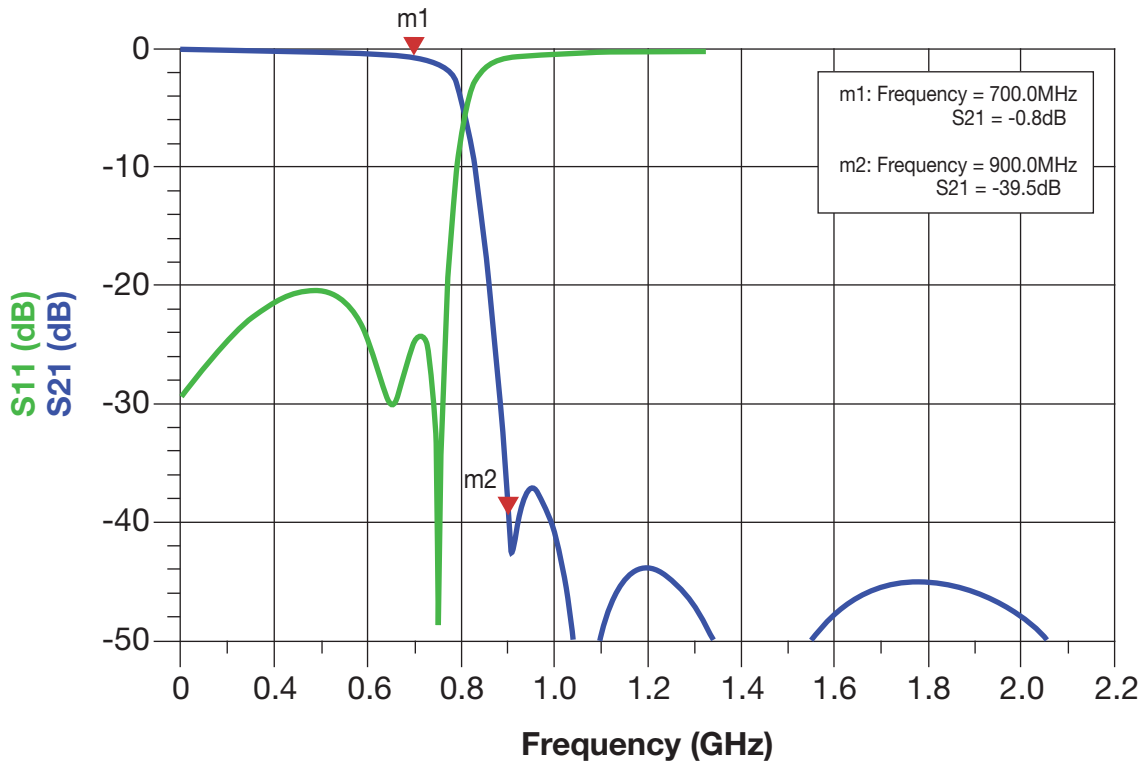

4



Thin-Film RF/Microwave Products Designer Kits

Accu-P[®]/Accu-L[®] Kits

RF/Microwave Thin-Film Products



Designer Kits *(Special Kits Available Upon Request)*

Accu-P®
Designer Kit Type 1700LF
Order Number: Accu-P®0201KITL2

| Volts | Capacitors Value (pF) | Tolerance |
|-------|-----------------------|-----------|
| 100 | 0.1 | P |
| | 0.2 | P |
| | 0.3 | P |
| | 0.4 | P |
| | 0.5 | P |
| 50 | 0.6 | P |
| | 0.7 | P |
| | 0.8 | P |
| | 0.9 | P |
| | 1.0 | P |
| | 1.1 | A |
| | 1.2 | A |
| | 1.3 | A |
| | 1.5 | A |
| | 25 | 1.8 |
| 2.0 | | B |
| 2.2 | | B |
| 2.4 | | B |
| 2.7 | | B |
| 3.0 | | B |
| 3.3 | | B |
| 3.6 | | B |
| 3.9 | | B |
| 4.7 | | B |
| 5.6 | | B |
| 6.8 | | B |
| 16 | 7.5 | B |
| | 8.2 | B |
| | 10.0 | G |
| | 12.0 | G |

600 Capacitors, 20 each of 30 values
Tolerance P = ±0.02pF A = ±0.05pF
B = ±0.1pF G = ±2%

Accu-P®
Designer Kit Type 1800LF
Order Number: Accu-P®0201KITL3

| Volts | Capacitors Value (pF) | Tolerance |
|-------|-----------------------|-----------|
| 50 | 1.0 | A |
| | 1.1 | A |
| | 1.2 | A |
| | 1.3 | A |
| | 1.4 | A |
| | 1.5 | A |
| | 1.6 | A |
| 25 | 1.7 | A |
| | 1.8 | A |
| | 1.9 | A |
| | 2.0 | A |
| | 2.1 | B |
| | 2.2 | B |
| | 2.3 | B |
| | 2.4 | B |
| | 2.5 | B |
| | 2.6 | B |
| | 2.7 | B |
| | 2.8 | B |
| | 2.9 | B |
| 3.0 | B | |
| 3.1 | B | |
| 3.3 | B | |
| 3.4 | B | |
| 3.6 | B | |
| 3.9 | B | |
| 4.1 | B | |
| 4.3 | B | |
| 4.5 | B | |
| 4.7 | B | |

600 Capacitors, 20 each of 30 values
Tolerance A = ±0.05pF
B = ±0.1pF

Accu-P®
Designer Kit Type 1300LF
Order Number: Accu-P®0402KITL1

| Volts | Capacitors Value (pF) | Tolerance |
|-------|-----------------------|-----------|
| 100 | 0.1 | P |
| | 0.2 | P |
| | 0.3 | P |
| | 0.4 | P |
| | 0.5 | P |
| | 0.6 | P |
| | 0.7 | P |
| | 0.8 | P |
| | 0.9 | P |
| | 1.0 | P |
| | 1.1 | A |
| | 1.2 | A |
| | 1.5 | A |
| 50 | 1.8 | A |
| | 2.0 | A |
| | 2.2 | B |
| | 2.4 | B |
| | 2.7 | B |
| | 3.0 | B |
| | 3.3 | B |
| | 3.9 | B |
| | 4.7 | B |
| | 5.6 | B |
| 25 | 6.8 | B |
| | 8.2 | B |
| | 10.0 | G |
| | 12.0 | G |
| | 15.0 | G |
| 16 | 18.0 | G |
| | 22.0 | G |

600 Capacitors, 20 each of 30 values
Tolerance P = ±0.02pF A = ±0.05pF
B = ±0.1pF G = ±2%

Accu-P®
Designer Kit Type 1400LF
Order Number: Accu-P®0402KITL2

| Volts | Capacitors Value (pF) | Tolerance |
|-------|-----------------------|-----------|
| 100 | 1.0 | A |
| | 1.1 | A |
| | 1.2 | A |
| | 1.3 | A |
| | 1.4 | A |
| | 1.5 | A |
| | 1.6 | A |
| | 1.7 | A |
| | 1.8 | A |
| | 50 | 1.9 |
| 2.0 | | A |
| 2.1 | | B |
| 2.2 | | B |
| 2.3 | | B |
| 2.4 | | B |
| 2.5 | | B |
| 2.6 | | B |
| 2.7 | | B |
| 2.8 | | B |
| 2.9 | | B |
| 3.0 | | B |
| 3.1 | | B |
| 3.3 | | B |
| 3.4 | | B |
| 3.6 | | B |
| 3.9 | | B |
| 4.1 | | B |
| 4.3 | | B |
| 4.5 | B | |
| 4.7 | B | |

600 Capacitors, 20 each of 30 values
Tolerance A = ±0.05pF
B = ±0.1pF

Accu-P®
Designer Kit Type 900LF
Order Number: Accu-P®0603KITL1

| Volts | Capacitors Value (pF) | Tolerance |
|-------|-----------------------|-----------|
| 100 | 0.1 | A |
| | 0.2 | A |
| | 0.3 | A |
| | 0.4 | B |
| | 0.5 | B |
| | 0.6 | B |
| | 0.7 | B |
| | 0.8 | B |
| | 0.9 | B |
| | 1.0 | B |
| | 1.1 | B |
| | 1.2 | B |
| | 1.5 | B |
| | 1.8 | B |
| | 2.0 | B |
| | 2.2 | B |
| | 2.4 | B |
| | 2.7 | B |
| | 50 | 3.0 |
| 3.3 | | B |
| 3.9 | | B |
| 4.7 | | B |
| 5.6 | | B |
| 6.8 | | B |
| 8.2 | | B |
| 10.0 | | G |
| 12.0 | | G |
| 15.0 | | G |
| 25 | 18.0 | G |
| | 22.0 | G |

600 Capacitors, 20 each of 30 values
Tolerance A = ±0.05pF
B = ±0.1pF
G = ±2%

Accu-P®
Designer Kit Type 800LF
Order Number: Accu-P®0805KITL2

| Volts | Capacitors Value (pF) | Tolerance |
|-------|-----------------------|-----------|
| 100 | 0.1 | A |
| | 0.2 | A |
| | 0.3 | A |
| | 0.4 | A |
| | 0.5 | B |
| | 0.7 | B |
| | 0.8 | B |
| | 0.9 | B |
| | 1.0 | B |
| | 1.2 | B |
| | 1.5 | B |
| | 1.8 | B |
| | 2.0 | B |
| | 2.2 | B |
| | 50 | 2.7 |
| 3.3 | | B |
| 3.9 | | B |
| 4.7 | | B |
| 5.6 | | B |
| 6.8 | | B |
| 8.2 | | B |
| 10.0 | | G |
| 12.0 | | G |
| 15.0 | | G |
| 25 | 18.0 | G |
| | 22.0 | G |
| | 27.0 | J |
| | 33.0 | J |
| | 39.0 | J |
| | 47.0 | J |

300 Capacitors, 10 each of 30 values
Tolerance A = ±0.05pF G = ±2%
B = ±0.1pF J = ±5%

Accu-P®
Designer Kit Type 2800LF
Order Number: Accu-P®0201KITL5

| Volts | Capacitors Value (pF) | Tolerance | |
|-------|-----------------------|-----------|---|
| 100 | 0.05 | Z | |
| | 0.10 | Z | |
| | 0.15 | Z | |
| | 0.20 | Z | |
| | 0.25 | Z | |
| | 0.30 | Z | |
| | 0.35 | Z | |
| | 0.40 | Z | |
| | 0.45 | Z | |
| | 0.50 | Z | |
| | 50 | 0.55 | P |
| | | 0.60 | P |
| | | 0.65 | P |
| 0.70 | | P | |
| 0.75 | | P | |
| 0.80 | | P | |
| 0.85 | | P | |
| 0.90 | | P | |
| 0.95 | | P | |
| 1.0 | | P | |
| 1.1 | | P | |
| 1.2 | | P | |
| 1.3 | | P | |
| 1.4 | | P | |
| 1.5 | | P | |
| 25 | 1.6 | P | |
| | 1.7 | P | |
| | 1.8 | P | |
| | 1.9 | P | |
| | 2.0 | P | |

600 Capacitors, 20 each of 30 values
Tolerance Z = ±0.01pF
P = ±0.02pF

Accu-P®
Designer Kit Type 2700LF
Order Number: Accu-P®0402KITL4

| Volts | Capacitors Value (pF) | Tolerance |
|-------|-----------------------|-----------|
| 100 | 0.05 | Z |
| | 0.10 | Z |
| | 0.15 | Z |
| | 0.20 | Z |
| | 0.25 | Z |
| | 0.30 | Z |
| | 0.35 | Z |
| | 0.40 | Z |
| | 0.45 | Z |
| | 0.50 | Z |
| | 0.55 | P |
| | 0.60 | P |
| | 0.65 | P |
| | 0.70 | P |
| | 0.75 | P |
| | 0.80 | P |
| | 0.85 | P |
| | 0.90 | P |
| | 0.95 | P |
| 50 | 1.0 | P |
| | 1.1 | P |
| | 1.2 | P |
| | 1.3 | P |
| | 1.4 | P |
| | 1.5 | P |
| | 1.6 | P |
| | 1.7 | P |
| | 1.8 | P |
| | 1.9 | P |
| 2.0 | P | |

600 Capacitors, 20 each of 30 values
Tolerance Z = ±0.01pF
P = ±0.02pF

5



Accu-P®
Designer Kit Type 2200LF
Order Number: Accu-P® 0603KITL2

| Volts | Capacitors Value (pF) | Tolerance |
|-------|-----------------------|-----------|
| 100 | 0.05 | P |
| | 0.10 | P |
| | 0.15 | P |
| | 0.20 | P |
| | 0.25 | P |
| | 0.30 | P |
| | 0.35 | P |
| | 0.40 | P |
| | 0.45 | P |
| | 0.50 | P |
| | 0.55 | P |
| | 0.60 | P |
| | 0.65 | P |
| | 0.70 | P |
| | 0.75 | P |

300 Capacitors, 20 each of 15 values
Tolerance P = ± 0.02pF

Accu-P®
Designer Kit Type 700
Order Number: Accu-P® 1210KIT02

| Volts | Capacitors Value (pF) | Tolerance |
|-------|-----------------------|-----------|
| 100 | 1.0 | B |
| | 1.5 | B |
| | 1.8 | B |
| | 2.2 | B |
| | 2.7 | B |
| | 3.3 | B |
| | 4.7 | B |
| | 5.6 | B |
| | 6.8 | B |
| | 10.0 | G |
| | 12.0 | G |
| | 18.0 | G |
| | 22.0 | G |
| | 27.0 | G |
| | 33.0 | G |

150 Capacitors, 10 each of 15 values
Tolerance B = ± 0.1pF
G = ± 2%

Accu-P® 01005
Designer Kit Type 3100LF
Order Number: Accu-P® C005KITL1

| Volts | Capacitors Value (pF) | Tolerance |
|-------|-----------------------|-----------|
| 16 | 0.05 | P |
| | 0.1 | P |
| | 0.2 | P |
| | 0.3 | P |
| | 0.4 | P |
| | 0.5 | P |
| | 0.6 | P |
| | 0.7 | P |
| | 0.8 | P |
| | 0.9 | P |
| | 1.0 | Q |
| | 1.2 | Q |
| | 1.5 | Q |
| | 1.8 | Q |
| | 2.2 | Q |

7500 Capacitors, 500 each of 15 values
Tolerance P = ± 0.02pF
Q = ± 0.03pF

Accu-L® 0201
Designer Kit Type 3200
Order Number: Accu-L® 0201KIT1

| Inductance Value (nH) | Tolerance |
|-----------------------|-----------|
| 0.33 | A |
| 0.39 | A |
| 0.47 | A |
| 0.56 | A |
| 0.68 | A |
| 0.82 | A |
| 1.0 | A |
| 1.2 | A |
| 1.5 | B |
| 1.8 | B |
| 2.2 | B |
| 2.7 | B |
| 3.3 | B |

260 Inductors, 20 each of 13 values
Tolerance A = ±0.05nH
B = ±0.1nH

Accu-L®
Designer Kit Type 2500
Order Number: Accu-L® L0402KIT01

| Inductance Value (nH) | Tolerance |
|-----------------------|-----------|
| 0.82 | A |
| 1.0 | A |
| 1.2 | A |
| 1.5 | A |
| 1.8 | A |
| 2.2 | A |
| 2.7 | A |
| 3.3 | B |
| 3.9 | B |
| 4.7 | B |
| 5.6 | B |
| 6.8 | B |

240 Inductors, 20 each of 12 values
Tolerance A = ±0.05nH
B = ±0.1nH

Accu-L®
Designer Kit Type 1600LF
Order Number: Accu-L® 0603KITL2

| Inductance Value (nH) | Tolerance |
|-----------------------|-----------|
| 1.2 | C |
| 1.5 | C |
| 1.8 | C |
| 2.2 | C |
| 2.7 | C |
| 3.3 | C |
| 3.9 | C |
| 4.7 | C |
| 5.6 | C |
| 6.8 | C |
| 8.2 | C |
| 10 | G |
| 12 | G |
| 15 | G |

280 Inductors, 20 each of 14 values
Tolerance C = ±0.2nH
G = ±2%

Accu-L®
Designer Kit Type 1100LF
Order Number: Accu-L® 0805KITL2

| Inductance Value (nH) | Tolerance |
|-----------------------|-----------|
| 1.8 | C |
| 2.2 | C |
| 2.7 | C |
| 3.3 | C |
| 3.9 | C |
| 4.7 | C |
| 5.6 | C |
| 6.8 | D |
| 8.2 | D |
| 10.0 | J |
| 12.0 | J |
| 15.0 | J |
| 18.0 | J |
| 22.0 | J |

280 Inductors, 20 each of 14 values
Tolerance C = ±0.2nH
D = ±0.5nH
J = ±5%



Multilayer Organic (MLO™) Technology

MLO™ Capacitors

MLO™ Diplexers

MLO™ Inductors

MLO™ SMT Crossovers

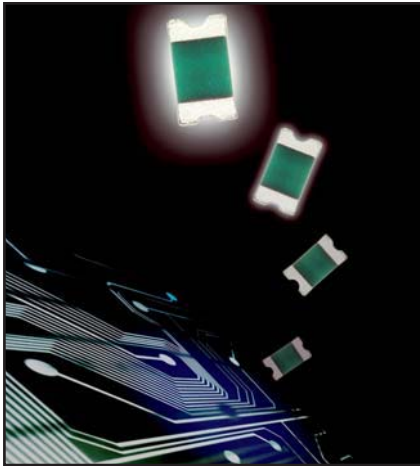

Based on its patented multilayer low loss organic (MLO™) technology. These new capacitors represent a paradigm shift from traditional ceramic and thin film passive SMD components. Multilayer Organic Capacitors (MLOC) are polymer based capacitors that use high conductivity copper interconnects in a multilayer fashion. The ability to fabricate these components on large area substrates and state of the art laser direct imaging allow for improved cost benefits and tolerance control. The end result is a state of the art low ESR and high SRF low profile RF capacitor that can support frequencies well above one GHz. Additionally MLOCs are expansion matched to printed circuit boards to allow for improved reliability.

FEATURES

- Low ESR
- Hi-Q®
- High Self Resonance
- Tight Tolerance
- Low Dielectric Absorption (0.0015%)

APPLICATIONS

- RF Power Amplifiers
- Low Noise Amplifiers
- Filter Networks
- Instrumentation

HOW TO ORDER

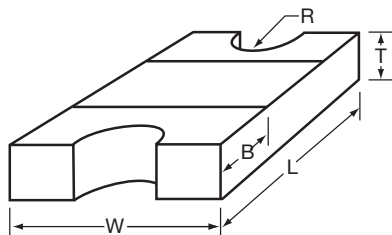
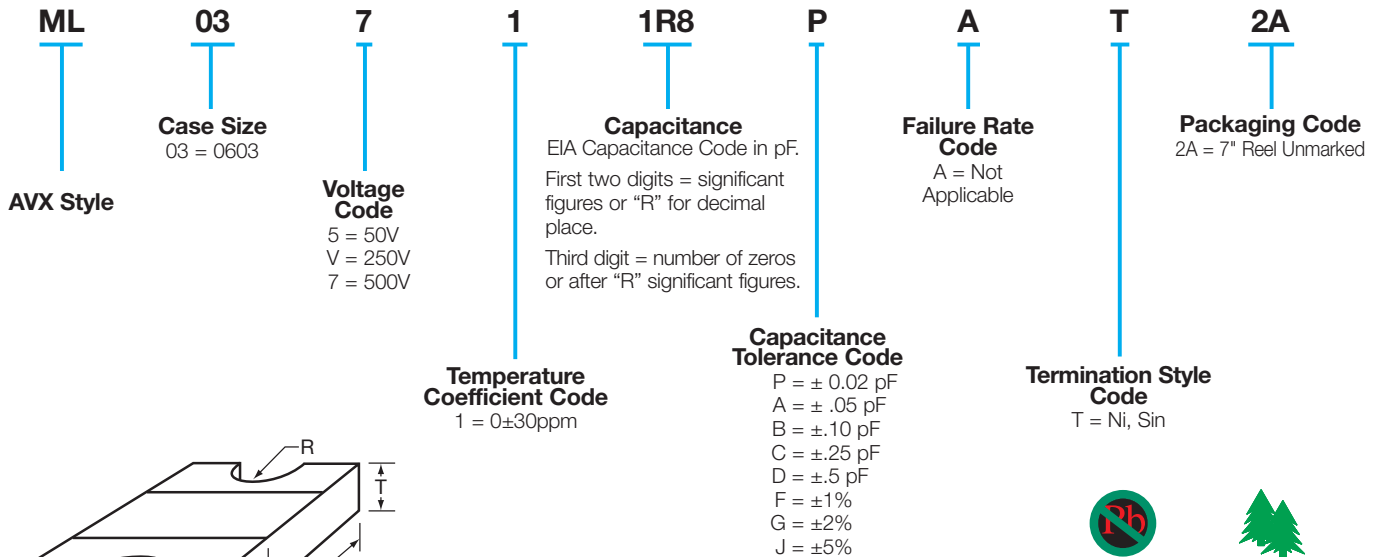

MECHANICAL DIMENSIONS: inches (millimeters)

| Case | Length (L) | Width (W) | Thickness (T) | Band Width (B) | Castellation Radius (R) |
|------|----------------------------------|----------------------------------|----------------------------------|----------------------------------|----------------------------------|
| 0603 | 0.063 ± 0.004 (1.600 ± 0.102) | 0.033 ± 0.004 (0.838 ± 0.102) | 0.025 ± 0.004 (0.635 ± 0.102) | 0.015 ± 0.005 (0.381 ± 0.127) | 0.008 ± 0.002 (0.203 ± 0.051) |

TAPE & REEL: All tape and reel specifications are in compliance with EIA RS481 (equivalent to IEC 286 part 3).

- 8mm carrier
- 7" reel, 3,000 pcs per reel

ENVIRONMENTAL CHARACTERISTICS

| TEST | CONDITIONS | REQUIREMENT |
|--|---|---|
| Life (Endurance) MIL-STD-202F Method 108A | 125°C, 2U _R , 1000 hours | No visible damage $\Delta C/C \leq 2\%$ for C $\geq 5\text{pF}$ $\Delta C/C \leq 0.25\text{pF}$ for C $< 5\text{pF}$ |
| Accelerated Damp Heat Steady State MIL-STD-202F Method 103B | 85°C, 85% RH, U _R , 1000 hours | No visible damage $\Delta C/C \leq 2\%$ for C $\geq 5\text{pF}$ $\Delta C/C \leq 0.25\text{pF}$ for C $< 5\text{pF}$ |
| Temperature Cycling MIL-STD-202F Method 107E MIL-STD-883D Method 1010.7 | -55°C to +125°C, 15 cycles – MLO™ | No visible damage $\Delta C/C \leq 2\%$ for C $\geq 5\text{pF}$ $\Delta C/C \leq 0.25\text{pF}$ for C $< 5\text{pF}$ |
| Resistance to Solder Heat IEC-68-2-58 | 260°C \pm 5°C for 10 secs. | C remains within initial limits |

MECHANICAL SPECIFICATIONS

| TEST | CONDITIONS | REQUIREMENT |
|---|---|---|
| Solderability IEC-68-2-58 | Components completely immersed in a solder bath at 235°C for 2 secs. | Terminations to be well tinned, minimum 95% coverage |
| Leach Resistance IEC-68-2-58 | Components completely immersed in a solder bath at 260 \pm 5°C for 60 secs. | Dissolution of termination faces $\leq 15\%$ of area Dissolution of termination edges $\leq 25\%$ of length |
| Adhesion MIL-STD-202F Method 211A | A force of 5N applied for 10 secs. | No visible damage |
| Termination Bond Strength IEC-68-2-21 Amend. 2 | Tested as shown in diagram | No visible damage $\Delta C/C \leq 2\%$ for C $\geq 5\text{pF}$ $\Delta C/C \leq 0.25\text{pF}$ for C $< 5\text{pF}$ |
| Robustness of Termination IEC-68-2-21 Amend. 2 | A force of 5N applied for 10 secs. | No visible damage |
| Storage | 12 months minimum with components stored in “as received” packaging | Good solderability |

QUALITY & RELIABILITY

MLO™ capacitors utilize high density interconnect wiring technology on well established low loss organic materials.

- Solderability;
- Dimensional, mechanical and temperature stability.

FINAL QUALITY INSPECTION

Finished parts are tested for standard electrical parameters and visual/mechanical characteristics. Each production lot is 100% evaluated for: capacitance and proof voltage at 2.5 U_R. In addition, production is periodically evaluated for:

- Average capacitance with histogram printout for capacitance distribution;
- IR and Breakdown Voltage distribution;
- Temperature Coefficient;

QUALITY ASSURANCE

The reliability of these multilayer organic capacitors has been extensively studied. Various methods and standards have been used to ensure a high quality component including JEDEC, Mil Spec and IPC testing. AVX's quality assurance policy is based on well established international industry standards. The reliability of the capacitors is determined by accelerated testing under the following conditions:

| | |
|------------------------------------|--|
| Life (Endurance) | 125°C, 2U _R , 1000 hours |
| Accelerated Damp Heat Steady State | 85°C, 85% RH, U _R , 1000 hours. |

TABLE I: CASE SIZE ML03

| Cap. pF | Cap. Tol. | WVDC | Cap. pF | Cap. Tol. | WVDC | Cap. pF | Cap. Tol. | WVDC |
|---------|------------|--------------|---------|------------|--------------|---------|------------|---------|
| 0.1 | P, A, B | 50, 250, 500 | 1.3 | P, A, B, C | 50, 250, 500 | 3.0 | P, A, B, C | 50, 250 |
| 0.2 | P, A, B | 50, 250, 500 | 1.4 | P, A, B, C | 50, 250, 500 | 3.3 | P, A, B, C | 50, 250 |
| 0.3 | P, A, B | 50, 250, 500 | 1.5 | P, A, B, C | 50, 250, 500 | 3.6 | P, A, B, C | 50, 250 |
| 0.4 | P, A, B | 50, 250, 500 | 1.6 | P, A, B, C | 50, 250, 500 | 3.9 | P, A, B, C | 50, 250 |
| 0.5 | P, A, B, C | 50, 250, 500 | 1.7 | P, A, B, C | 50, 250, 500 | | | |
| 0.6 | P, A, B, C | 50, 250, 500 | 1.8 | P, A, B, C | 50, 250, 500 | | | |
| 0.7 | P, A, B, C | 50, 250, 500 | 1.9 | P, A, B, C | 50, 250, 500 | | | |
| 0.8 | P, A, B, C | 50, 250, 500 | 2.0 | P, A, B, C | 50, 250, 500 | | | |
| 0.9 | P, A, B, C | 50, 250, 500 | 2.2 | P, A, B, C | 50, 250, 500 | | | |
| 1.0 | P, A, B, C | 50, 250, 500 | 2.4 | P, A, B, C | 50, 250, 500 | | | |
| 1.1 | P, A, B, C | 50, 250, 500 | 2.5 | P, A, B, C | 50, 250, 500 | | | |
| 1.2 | P, A, B, C | 50, 250, 500 | 2.7 | P, A, B, C | 50, 250 | | | |

Typical ESR vs. Frequency
MLO™ 0603

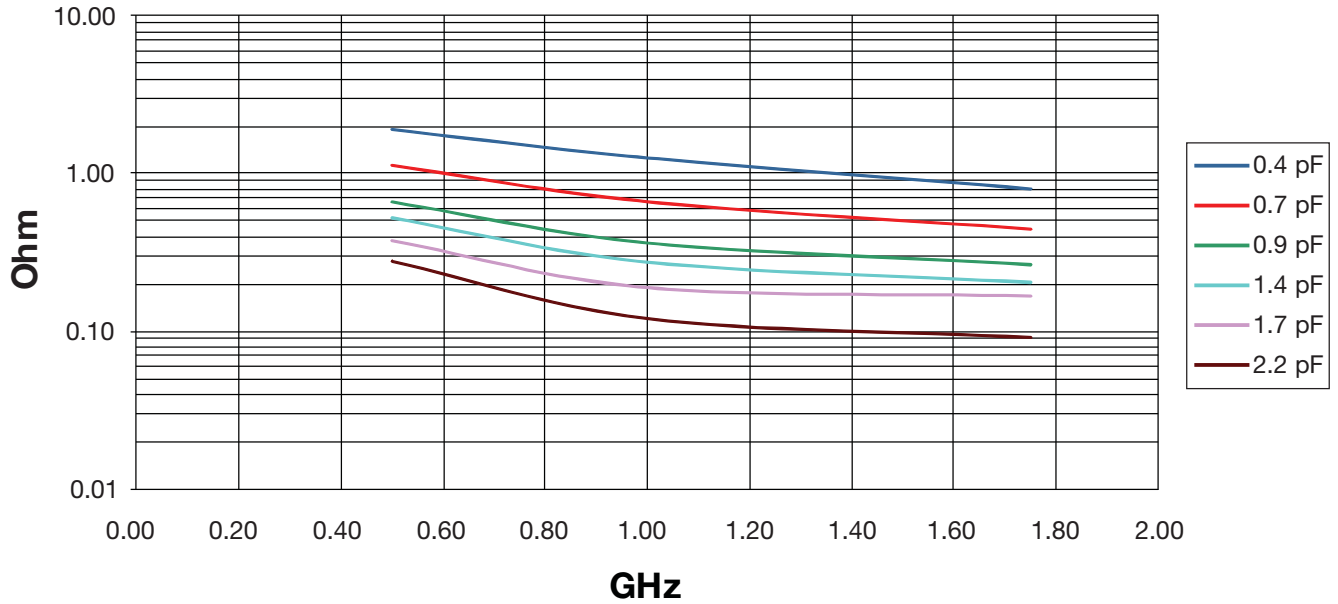

Typical Q vs. Frequency
MLO™ 0603

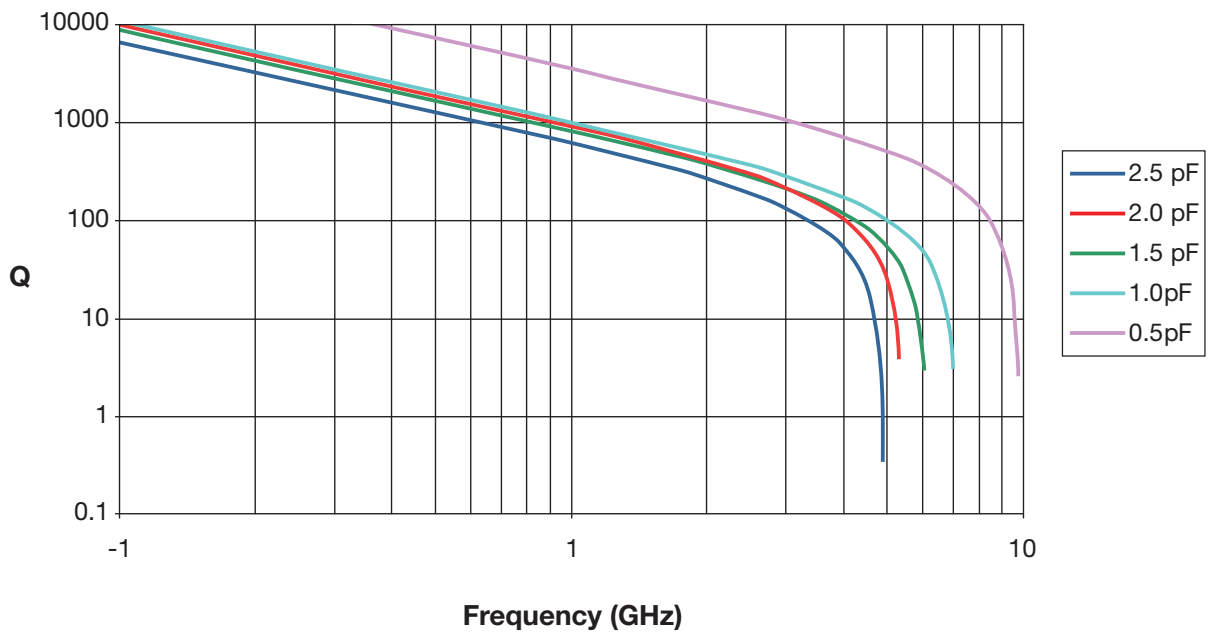

Typical Self Resonant Frequency vs. Capacitance
MLO™ 0603

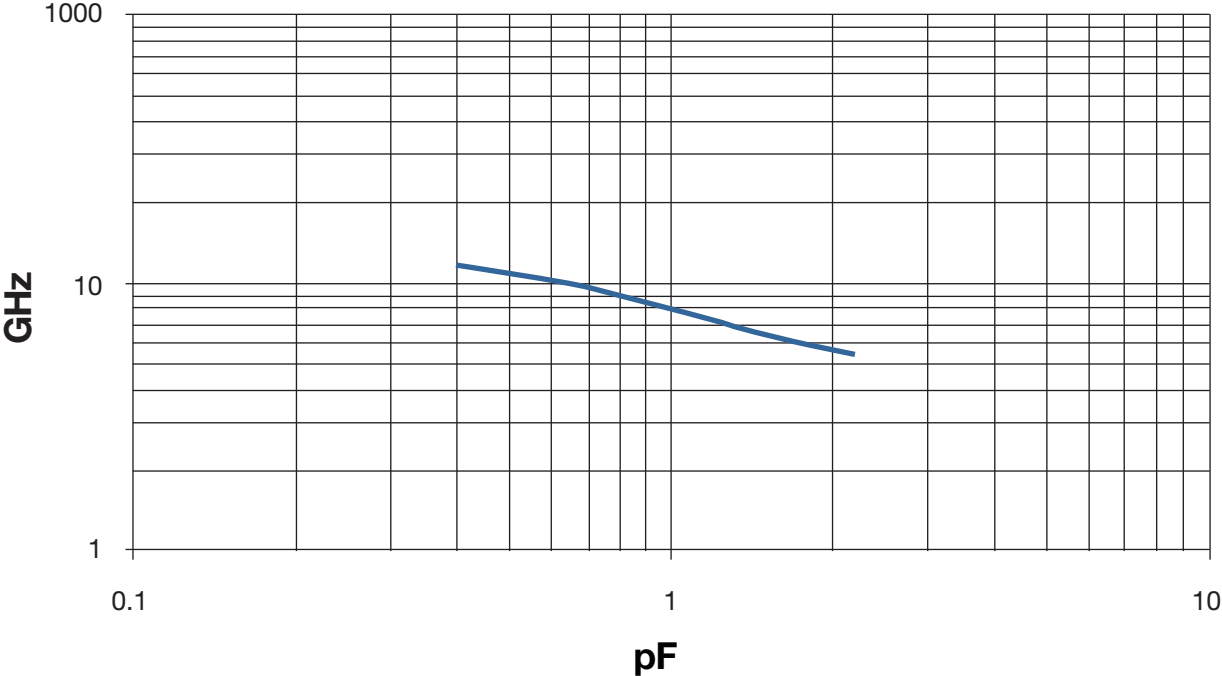

6

Multilayer Organic (MLO™)



0603 WLAN/BT Diplexer



MLO™ TECHNOLOGY

The 0603 diplexer is a best in class low profile multilayer organic passive device that is based on AVX's patented multilayer organic high density interconnect technology. The MLO™ diplexer uses high dielectric constant and low loss materials to realize high Q passive printed elements such as inductors, and capacitors in a multilayer stack up. The MLO™ diplexers can support multiple wireless standards such as WCDMA, CDMA, WLAN, GSM, and BT. These diplexers are less than 0.5mm in height and are ideally suited for band switching for dual band systems. All diplexers are expansion matched to printed circuit boards thereby resulting in improved reliability vs. ceramic and Si components.

APPLICATIONS

Multiband applications including WiFi, WiMax, GPS, and cellular bands

LAND GRID ARRAY ADVANTAGES

- Inherent Low Profile
- Excellent Solderability
- Low Parasitics
- High Heat Dissipation

HOW TO ORDER

DP **03** **B** **5425** **7** **TR**
 Type Size Design Frequency (MHz) Finish Packaging
 7 = Au
 T = NiSn
 Tape & Reel



COMPONENT DIMENSIONS AND FUNCTIONS

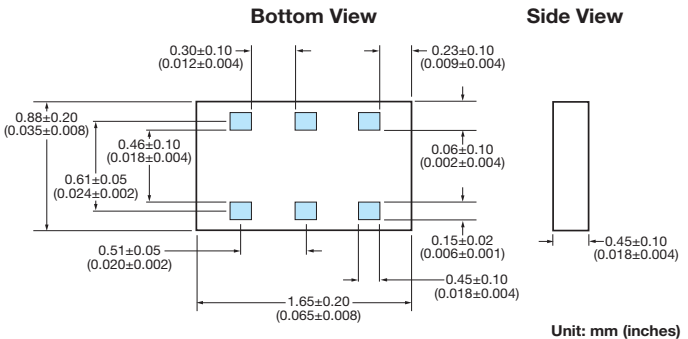

QUALITY INSPECTION

Finished parts are 100% tested for electrical parameters and visual characteristics.

OPERATING TEMPERATURE

-40°C to +85°C

TERMINATION

Finishes available in Ni Au, Ni Sn and OSP coatings which are compatible with automatic soldering technologies which include reflow, wave soldering, vapor phase and manual.

| Terminal No. | Terminal Name |
|--------------|---------------------|
| 1 | GND |
| 2 | Common |
| 3 | GND |
| 4 | Low Frequency Port |
| 5 | GND |
| 6 | High Frequency Port |

PART NUMBER: DP03B54257TR

Electrical Characteristics @ 25°C

| No. | Parameter | Freq. (MHz) | Port | Specification | Typ. value | Unit |
|-----|----------------|-------------|-----------|---------------|------------|------|
| 1 | Insertion Loss | 2400-2496 | Low | 0.55 max | 0.40 | dB |
| 2 | | 4900-5950 | High | 1.2 max | 0.80 | dB |
| 3 | Attenuation | 500-2700 | High | 28 min | 35 | dB |
| 4 | | 9800-11900 | High | 10 min | 14 | dB |
| 6 | Attenuation | 4800-4992 | Low | 20 min | 25 | dB |
| 7 | | 4900-5950 | Low | 23 min | 27 | dB |
| 8 | Attenuation | 7200-7500 | Low | 26 min | 30 | dB |
| 9 | | 500-2700 | Low-High | 28 min | 35 | dB |
| 10 | Isolation | 4900-5950 | Low-High | 22 min | 25 | dB |
| 11 | | VSWR | 2400-2500 | Ant | 2.0 max | 1.5 |
| 12 | VSWR | 4900-5950 | Ant | 2.0 max | 1.3 | - |
| 13 | VSWR | 2400-2500 | Low | 2.0 max | 1.5 | - |
| 14 | VSWR | 4900-5950 | High | 2.0 max | 1.3 | - |

ORIENTATION IN TAPE

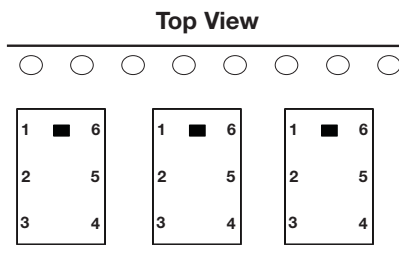

POWER CAPACITY

4.5W Maximum

Mechanical Characteristics @ 25°C

| | |
|---------------------------|-----------------------------|
| Size [mm(inches)] | 1.65 x 0.88 (0.065 x 0.035) |
| Height [mm(inches)] | 0.42 (0.017) |
| Volume (mm ³) | 0.77 |



S PARAMETER MEASUREMENTS

LOW BAND PORT ATTENUATION

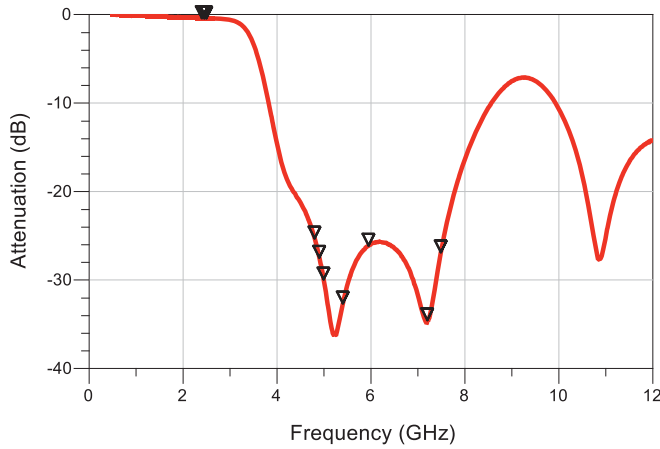

Low Band Attenuation

| Frequency | Attenuation |
|-----------|-------------|
| 4.800 GHz | 25.302 |
| 4.992 GHz | 29.935 |
| 4.900 GHz | 27.471 |
| 5.400 GHz | 32.647 |
| 5.590 GHz | 26.099 |
| 7.200 GHz | 34.531 |
| 7.488 GHz | 26.860 |

HIGH BAND PORT ATTENUATION

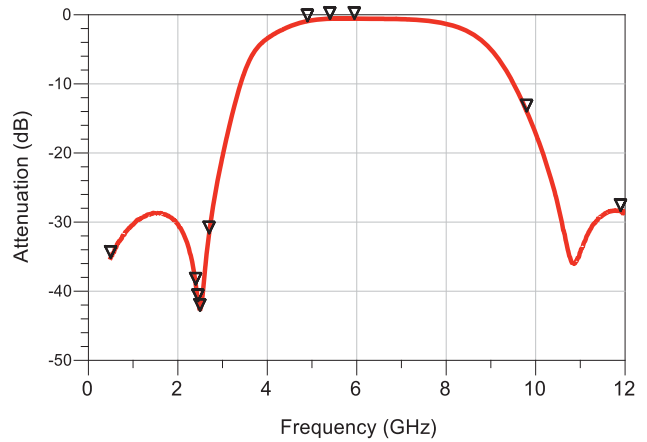

High Band Attenuation

| Frequency | Attenuation |
|-----------|-------------|
| 0.500 GHz | 35.133 |
| 2.400 GHz | 39.019 |
| 2.450 GHz | 41.406 |
| 2.496 GHz | 42.793 |
| 2.700 GHz | 31.607 |
| 9.800 GHz | 13.967 |
| 11.90 GHz | 28.352 |

LOW BAND INSERTION LOSS

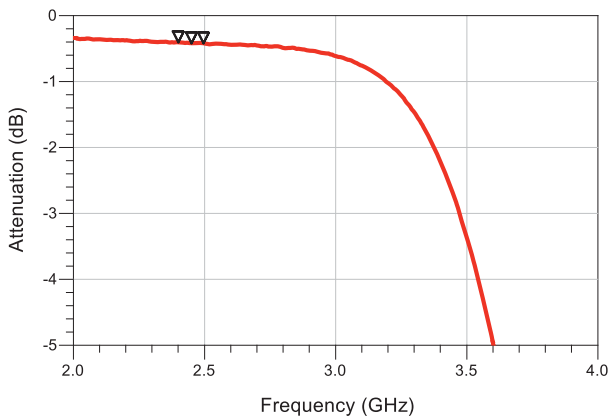

Low Band Insertion Loss

| Frequency | Insertion Loss |
|-----------|----------------|
| 2.400 GHz | 0.404 |
| 2.450 GHz | 0.418 |
| 2.496 GHz | 0.420 |

HIGH BAND INSERTION LOSS

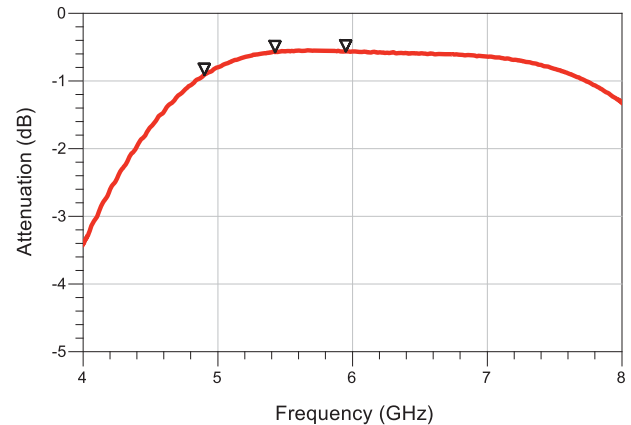

High Band Insertion Loss

| Frequency | Insertion Loss |
|-----------|----------------|
| 4.900 GHz | 0.909 |
| 5.400 GHz | 0.577 |
| 5.950 GHz | 0.562 |

6

S PARAMETER MEASUREMENTS

COMMON PORT RETURN LOSS

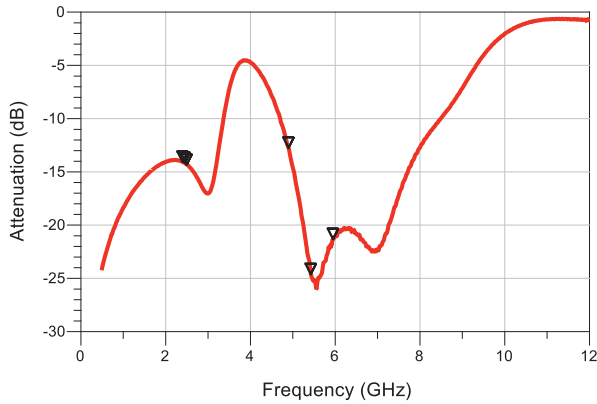

Common Return Loss

| Frequency | Return Loss | VSWR |
|-----------|-------------|-------|
| 2.400 GHz | 14.066 | 1.494 |
| 2.450 GHz | 14.162 | 1.487 |
| 2.496 GHz | 14.325 | 1.476 |
| 4.900 GHz | 12.750 | 1.599 |
| 5.400 GHz | 24.603 | 1.125 |
| 5.950 GHz | 21.310 | 1.188 |

ISOLATION

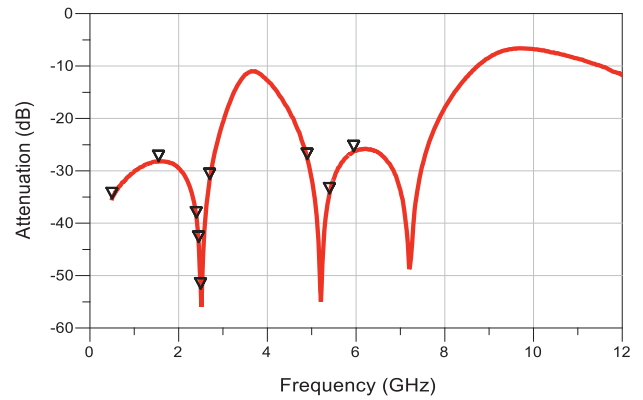

Isolation

| Frequency | Attenuation |
|-----------|-------------|
| 0.500 GHz | 32.253 |
| 1.550 GHz | 28.144 |
| 2.400 GHz | 28.913 |
| 2.450 GHz | 43.562 |
| 2.496 GHz | 52.470 |
| 2.700 GHz | 31.566 |
| 4.900 GHz | 27.731 |
| 5.400 GHz | 34.304 |
| 5.950 GHz | 26.249 |

LOW BAND RETURN LOSS

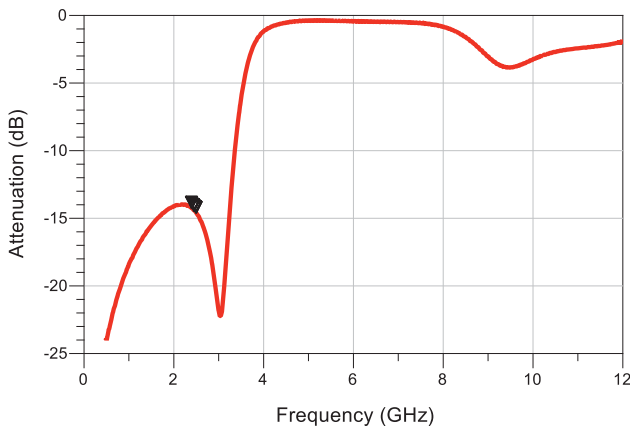

Low Band Return Loss

| Frequency | Return Loss | VSWR |
|-----------|-------------|-------|
| 2.400 GHz | 14.232 | 1.482 |
| 2.450 GHz | 14.429 | 1.469 |
| 2.496 GHz | 14.572 | 1.459 |

HIGH BAND RETURN LOSS

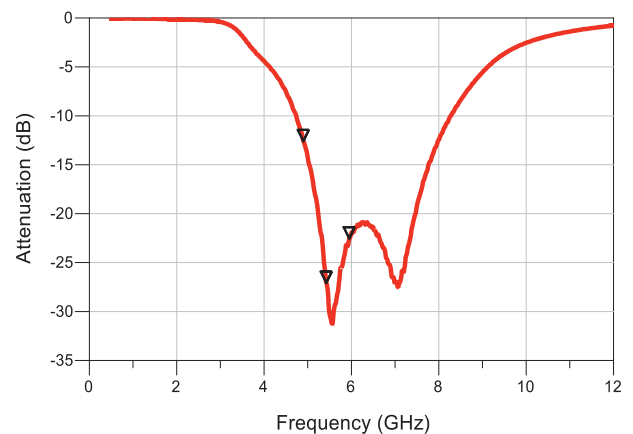

High Band Return Loss

| Frequency | Return Loss | VSWR |
|-----------|-------------|-------|
| 4.900 GHz | 12.587 | |
| 5.400 GHz | 27.577 | 1.087 |
| 5.950 GHz | 22.533 | 1.161 |

Multilayer Organic (MLO™)



0603 WLAN/BT Diplexer



MLO™ TECHNOLOGY

The 0603 diplexer is a best in class low profile multilayer organic passive device that is based on AVX's patented multilayer organic high density interconnect technology. The MLO™ diplexer uses high dielectric constant and low loss materials to realize high Q passive printed elements such as inductors, and capacitors in a multilayer stack up. The MLO™ diplexers can support multiple wireless standards such as WCDMA, CDMA, WLAN, GSM, and BT. These diplexers are less than 0.5mm in height and are ideally suited for band switching for dual band systems. All diplexers are expansion matched to printed circuit boards thereby resulting in improved reliability vs. ceramic and Si components.

APPLICATIONS

Multiband applications including WiFi, WiMax, GPS, and cellular bands

LAND GRID ARRAY ADVANTAGES

- Inherent Low Profile
- Excellent Solderability
- Low Parasitics
- High Heat Dissipation

HOW TO ORDER

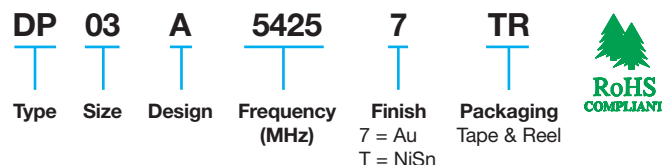

QUALITY INSPECTION

Finished parts are 100% tested for electrical parameters and visual characteristics.

OPERATING TEMPERATURE

-40°C to +85°C

TERMINATION

Finishes available in Ni Au, Ni Sn and OSP coatings which are compatible with automatic soldering technologies which include reflow, wave soldering, vapor phase and manual.

ORIENTATION IN TAPE

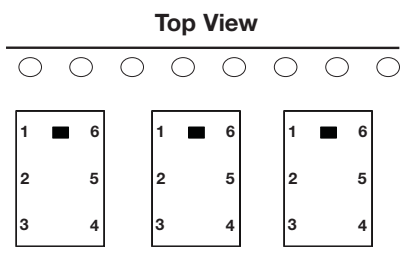

POWER CAPACITY

4.5W Maximum

COMPONENT DIMENSIONS AND FUNCTIONS

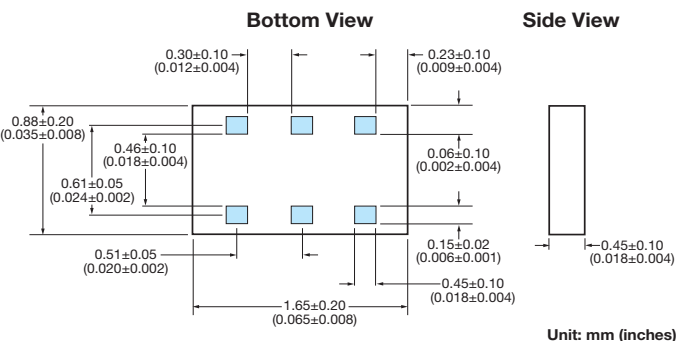

| Terminal No. | Terminal Name |
|--------------|---------------------|
| 1 | Low Frequency Port |
| 2 | GND |
| 3 | High Frequency Port |
| 4 | GND |
| 5 | Common |
| 6 | GND |

PART NUMBER: DP03A54257TR

Electrical Characteristics @ 25°C

| No. | Parameter | Freq. (MHz) | Port | Specification | Typ. value | Unit |
|-----|----------------|-------------|----------|---------------|------------|------|
| 1 | Insertion Loss | 2400-2496 | Low | 0.55 max | 0.40 | dB |
| 2 | | 4900-5950 | High | 1.2 max | 0.80 | dB |
| 3 | Attenuation | 500-2700 | High | 28 min | 35 | dB |
| 4 | | 9800-11900 | High | 10 min | 14 | dB |
| 6 | Attenuation | 4800-4992 | Low | 20 min | 25 | dB |
| 7 | | 4900-5950 | Low | 23 min | 27 | dB |
| 8 | Attenuation | 7200-7500 | Low | 26 min | 30 | dB |
| 9 | Isolation | 500-2700 | Low-High | 28 min | 35 | dB |
| 10 | | 4900-5950 | Low-High | 22 min | 25 | dB |
| 11 | VSWR | 2400-2500 | Ant | 2.0 max | 1.5 | - |
| 12 | VSWR | 4900-5950 | Ant | 2.0 max | 1.3 | - |
| 13 | VSWR | 2400-2500 | Low | 2.0 max | 1.5 | - |
| 14 | VSWR | 4900-5950 | High | 2.0 max | 1.3 | - |

Mechanical Characteristics @ 25°C

| | |
|---------------------------|-----------------------------|
| Size [mm(inches)] | 1.65 x 0.88 (0.065 x 0.035) |
| Height [mm(inches)] | 0.42 (0.017) |
| Volume (mm ³) | 0.77 |



S PARAMETER MEASUREMENTS

LOW BAND PORT ATTENUATION

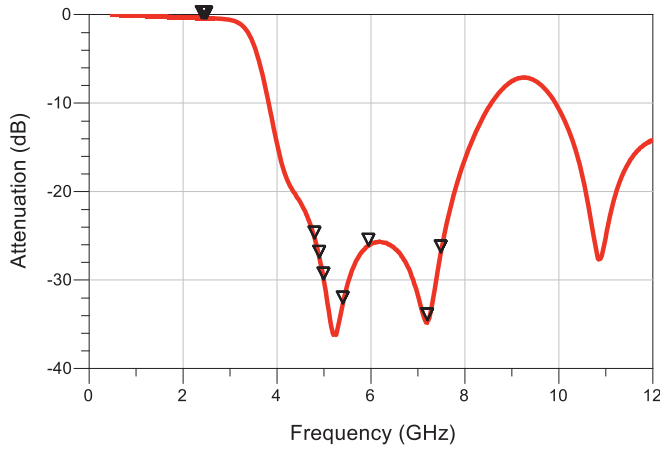

Low Band Attenuation

| Frequency | Attenuation |
|-----------|-------------|
| 4.800 GHz | 25.302 |
| 4.992 GHz | 29.935 |
| 4.900 GHz | 27.471 |
| 5.400 GHz | 32.647 |
| 5.590 GHz | 26.099 |
| 7.200 GHz | 34.531 |
| 7.488 GHz | 26.860 |

HIGH BAND PORT ATTENUATION

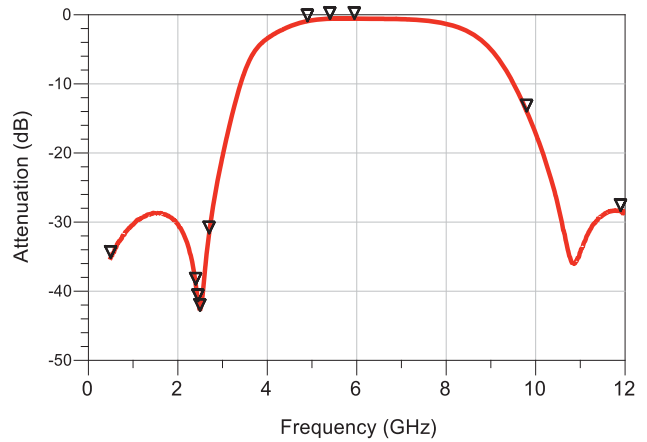

High Band Attenuation

| Frequency | Attenuation |
|-----------|-------------|
| 0.500 GHz | 35.133 |
| 2.400 GHz | 39.019 |
| 2.450 GHz | 41.406 |
| 2.496 GHz | 42.793 |
| 2.700 GHz | 31.607 |
| 9.800 GHz | 13.967 |
| 11.90 GHz | 28.352 |

LOW BAND INSERTION LOSS

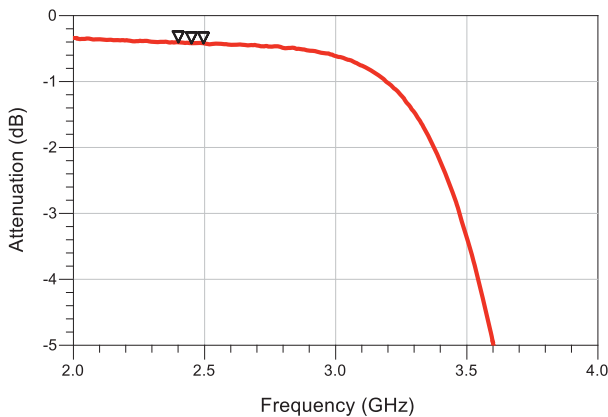

Low Band Insertion Loss

| Frequency | Insertion Loss |
|-----------|----------------|
| 2.400 GHz | 0.404 |
| 2.450 GHz | 0.418 |
| 2.496 GHz | 0.420 |

HIGH BAND INSERTION LOSS

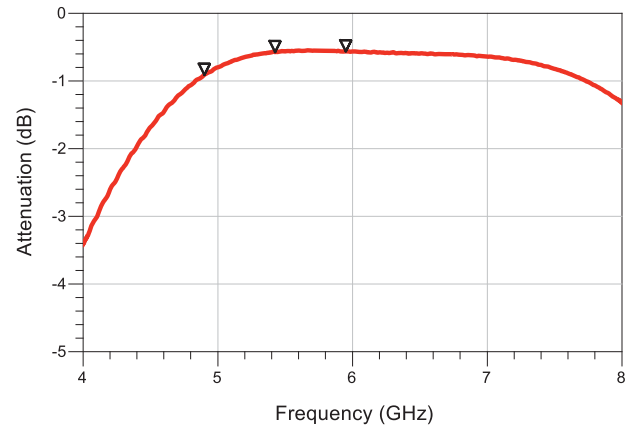

High Band Insertion Loss

| Frequency | Insertion Loss |
|-----------|----------------|
| 4.900 GHz | 0.909 |
| 5.400 GHz | 0.577 |
| 5.950 GHz | 0.562 |

S PARAMETER MEASUREMENTS

COMMON PORT RETURN LOSS

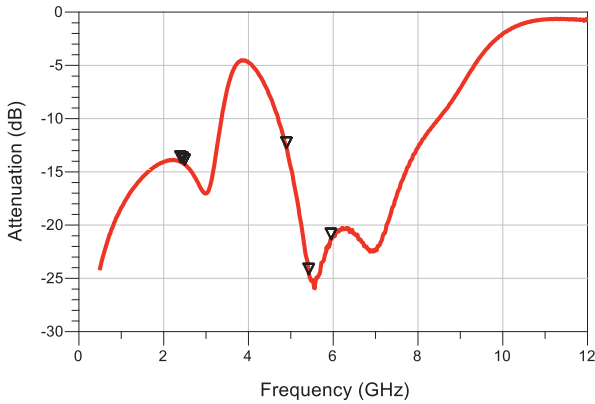

Common Return Loss

| Frequency | Return Loss | VSWR |
|-----------|-------------|-------|
| 2.400 GHz | 14.066 | 1.494 |
| 2.450 GHz | 14.162 | 1.487 |
| 2.496 GHz | 14.325 | 1.476 |
| 4.900 GHz | 12.750 | 1.599 |
| 5.400 GHz | 24.603 | 1.125 |
| 5.950 GHz | 21.310 | 1.188 |

ISOLATION

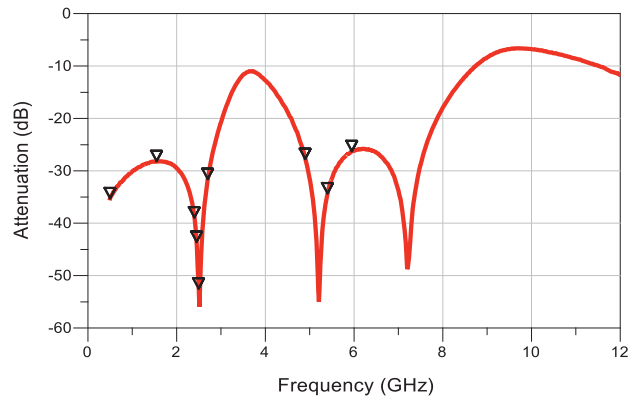

Isolation

| Frequency | Attenuation |
|-----------|-------------|
| 0.500 GHz | 32.253 |
| 1.550 GHz | 28.144 |
| 2.400 GHz | 28.913 |
| 2.450 GHz | 43.562 |
| 2.496 GHz | 52.470 |
| 2.700 GHz | 31.566 |
| 4.900 GHz | 27.731 |
| 5.400 GHz | 34.304 |
| 5.950 GHz | 26.249 |

LOW BAND RETURN LOSS

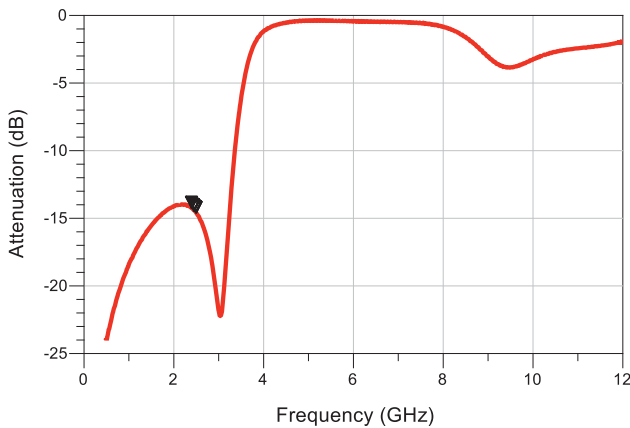

Low Band Return Loss

| Frequency | Return Loss | VSWR |
|-----------|-------------|-------|
| 2.400 GHz | 14.232 | 1.482 |
| 2.450 GHz | 14.429 | 1.469 |
| 2.496 GHz | 14.572 | 1.459 |

HIGH BAND RETURN LOSS

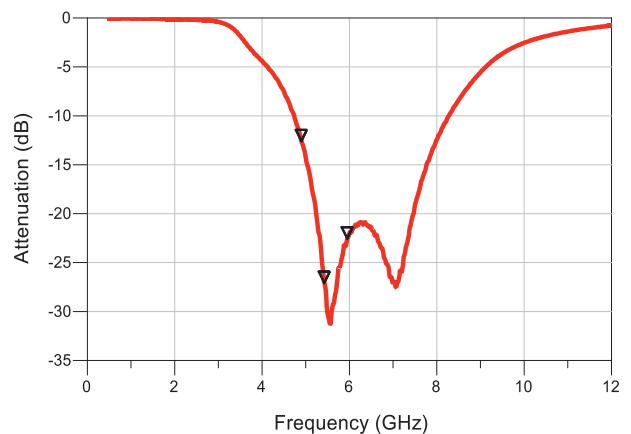

High Band Return Loss

| Frequency | Return Loss | VSWR |
|-----------|-------------|-------|
| 4.900 GHz | 12.587 | |
| 5.400 GHz | 27.577 | 1.087 |
| 5.950 GHz | 22.533 | 1.161 |

6

Multilayer Organic (MLO™)



0805 CDMA Diplexer



MLO™ TECHNOLOGY

The 0805 diplexer is a best in class low profile multilayer organic passive device that is based on AVX's patented multilayer organic high density interconnect technology. The MLO™ diplexer uses high dielectric constant and low loss materials to realize high Q passive printed passive elements such as inductors and capacitors in a multilayer stack up. The MLO™ diplexers can support multiple wireless standards such as WCDMA, CDMA, WLAN, and GSM and are less than 0.6mm in thickness. These components are ideally suited for band switching for dual band systems. All diplexers are expansion matched to FR4 thereby resulting in improved reliability over standard Si and ceramic devices.

APPLICATIONS

Multiband applications including WCDMA, WLAN, WiMax, GPS, and cellular bands

LAND GRID ARRAY ADVANTAGES

- Low Insertion Loss
- Excellent Solderability
- Low Parasitics
- Low Profile

HOW TO ORDER

DP **05** **A** **1920** **7** **TR**
 Type Size Design Frequency (MHz) Finish Packaging
 7 = Au TR = 3 Kpcs
 T = NiSn TR/500 = 500 pcs



COMPONENT DIMENSIONS AND FUNCTIONS

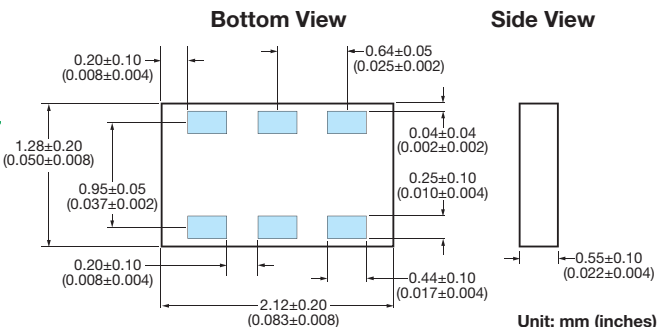

QUALITY INSPECTION

Finished parts are 100% tested for electrical parameters and visual characteristics.

OPERATING TEMPERATURE

-40°C to +85°C

TERMINATION

Finishes available in Ni/Sn, Immersion Sn, Immersion Au and OSP coatings which are compatible with automatic soldering technologies which include reflow, wave soldering, vapor phase and manual.

ORIENTATION IN TAPE

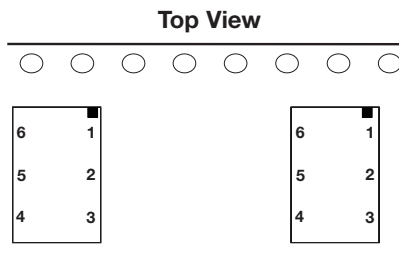

| Terminal No. | Terminal Name |
|--------------|---------------------|
| 1 | High Frequency Port |
| 2 | GND |
| 3 | Low Frequency Port |
| 4 | GND |
| 5 | Common Port |
| 6 | GND |

PART NUMBER: DP05A19207TR

| Specification @ 25°C | |
|---------------------------------|-----------------------------|
| Size [mm(inches)] | 2.12 x 1.28 (0.083 x 0.050) |
| Height [mm(inches)] | 0.55 (0.021) |
| Volume (mm ³) | 1.5 |
| Frequency Range (F1) (MHz) | 859±35 |
| Frequency Range (F2) (MHz) | 1920±70 |
| Insertion Loss (F1, at Fc) (dB) | -0.4 |
| Insertion Loss (F2, at Fc) (dB) | -0.6 |
| Attenuation (F1) at (F2) (dB) | -23 |
| Attenuation (F2) at (F1) (dB) | -23 |
| VSWR (Input @ F1) | 1.4 |
| VSWR (Input @ F2) | 1.3 |
| VSWR (Lowband @ F1) | 1.4 |
| VSWR (Highband @ F2) | 1.4 |

POWER CAPACITY

4.5W Maximum



S PARAMETER MEASUREMENTS

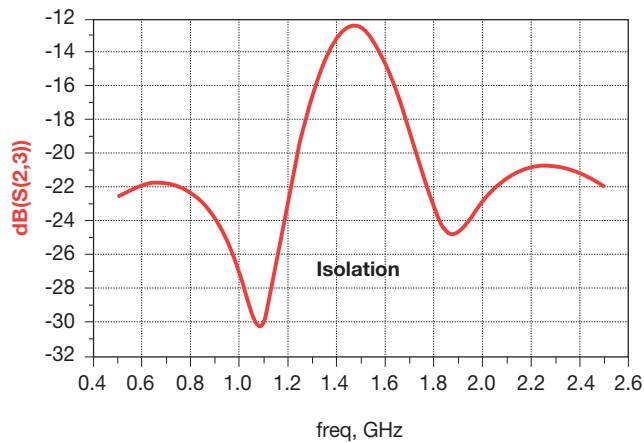
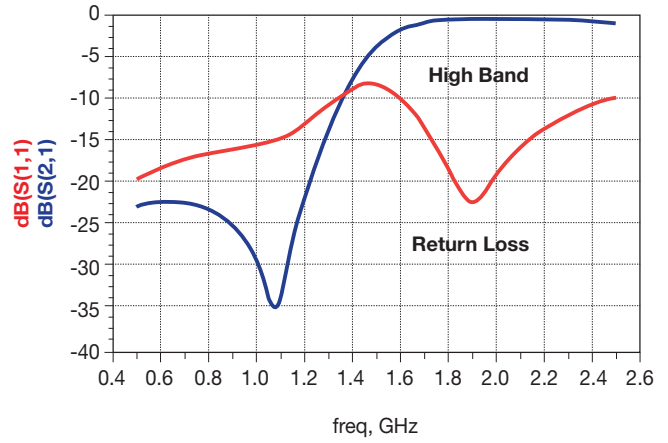
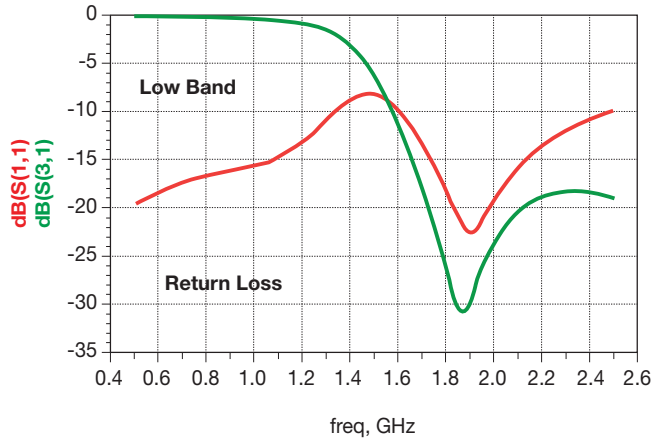

Note: Measurements were taken using an Anritsu 4 port VNA; Diplexer was mounted on a custom evaluation board. To reduce systematic errors from the VNA, the coaxial measurement cables, and evaluation board, a Short-Open-Load-Thru (SOLT) calibration was performed, using a custom fabricated calibration substrate. This is the most common coaxial calibration methods.

6

Multilayer Organic (MLO™)



0805 WCDMA Diplexer



MLO™ TECHNOLOGY

The 0805 diplexer is a best in class low profile multilayer organic passive device that is based on AVX's patented multilayer organic high density interconnect technology. The MLO™ diplexer uses high dielectric constant and low loss materials to realize high Q passive printed passive elements such as inductors and capacitors in a multilayer stack up. The MLO™ diplexers can support multiple wireless standards such as WCDMA, CDMA, WLAN, and GSM and are less than 0.6mm in thickness. These components are ideally suited for band switching for dual band systems. All diplexers are expansion matched to FR4 thereby resulting in improved reliability over standard Si and ceramic devices.

APPLICATIONS

Multiband applications including WCDMA, WLAN, WiMax, GPS, and cellular bands

LAND GRID ARRAY ADVANTAGES

- Low Insertion Loss
- Excellent Solderability
- Low Parasitics
- Low Profile

HOW TO ORDER

DP **05** **A** **1940** **7** **TR**
 Type Size Design Frequency (MHz) Finish Packaging
 7 = Au TR = 3 Kpcs
 T = NiSn TR/500 = 500 pcs



COMPONENT DIMENSIONS AND FUNCTIONS

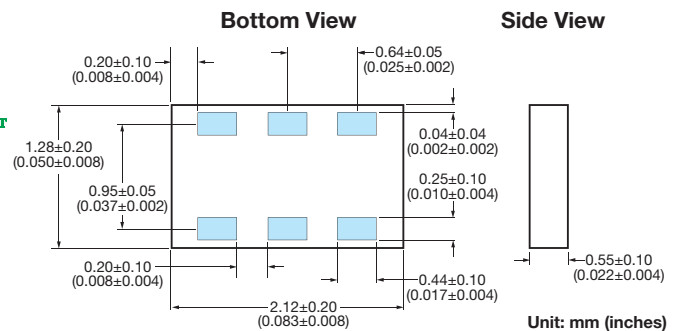

QUALITY INSPECTION

Finished parts are 100% tested for electrical parameters and visual characteristics.

OPERATING TEMPERATURE

-40°C to +85°C

TERMINATION

Finishes available in Ni/Sn, Immersion Sn, Immersion Au and OSP coatings which are compatible with automatic soldering technologies which include reflow, wave soldering, vapor phase and manual.

| Terminal No. | Terminal Name |
|--------------|---------------------|
| 1 | High Frequency Port |
| 2 | GND |
| 3 | Low Frequency Port |
| 4 | GND |
| 5 | Common Port |
| 6 | GND |

ORIENTATION IN TAPE

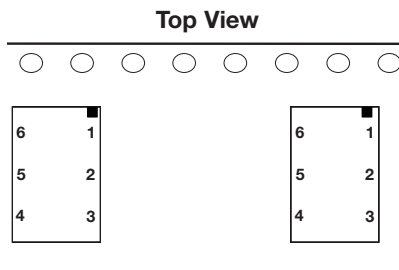

PART NUMBER: DP05A19407TR

POWER CAPACITY

4.5W Maximum

| Specification @ 25°C | |
|---------------------------------|-----------------------------|
| Size [mm(inches)] | 2.12 x 1.28 (0.083 x 0.050) |
| Height [mm(inches)] | 0.55 (0.021) |
| Volume (mm ³) | 1.5 |
| Frequency Range (F1) (MHz) | 892±68 |
| Frequency Range (F2) (MHz) | 1940±230 |
| Insertion Loss (F1, at Fc) (dB) | -0.4 |
| Insertion Loss (F2, at Fc) (dB) | -0.65 |
| Attenuation (F1) at (F2) (dB) | -23 |
| Attenuation (F2) at (F1) (dB) | -20 |
| VSWR (Input @ F1) | 1.3 |
| VSWR (Input @ F2) | 1.4 |
| VSWR (Lowband @ F1) | 1.4 |
| VSWR (Highband @ F2) | 1.2 |



S PARAMETER MEASUREMENTS

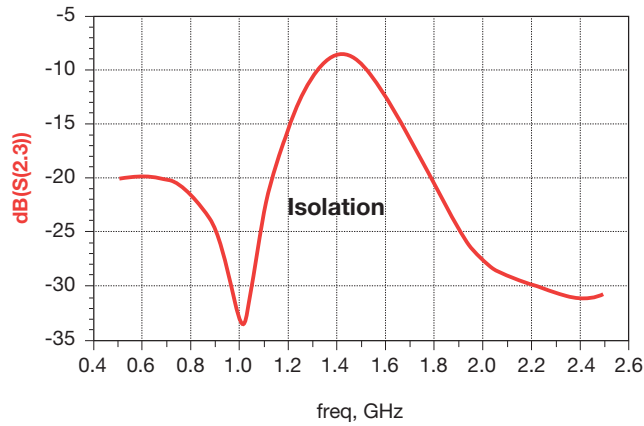
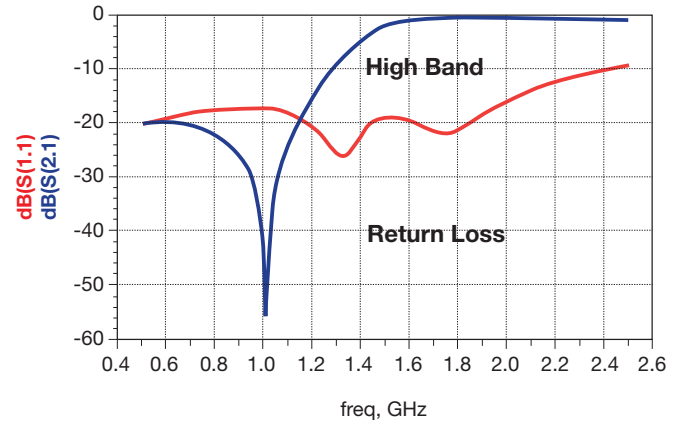
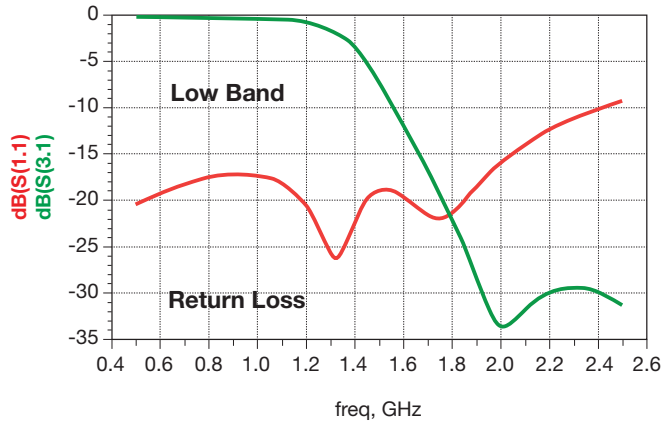

Note: Measurements were taken using an Anritsu 4 port VNA; Diplexer was mounted on a custom evaluation board. To reduce systematic errors from the VNA, the coaxial measurement cables, and evaluation board, a Short-Open-Load-Thru (SOLT) calibration was performed, using a custom fabricated calibration substrate. This is the most common coaxial calibration methods.

6

0805 WLAN Diplexer



MLO™ TECHNOLOGY

The 0805 diplexer is a best in class low profile multilayer organic passive device that is based on AVX's patented multilayer organic high density interconnect technology. The MLO™ diplexer uses high dielectric constant and low loss materials to realize high Q passive printed elements such as inductors and capacitors in a multilayer stack up. The MLO™ diplexers can support multiple wireless standards such as WCDMA, CDMA, WLAN and GSM. These components which are less than 0.6mm in thickness are ideally suited for band switching for dual band systems. All diplexers are expansion matched to FR4 thereby resulting in improved reliability over standard Si and ceramic devices.

APPLICATIONS

Multiband applications including WiFi, WiMax, GPS, and cellular bands

LAND GRID ARRAY ADVANTAGES

- Low Insertion Loss
- Excellent Solderability
- Low Parasitics
- Low Profile

HOW TO ORDER

| | | | | | | |
|-----------|-----------|----------|-----------------|------------------------------|---|--|
| DP | 05 | A | 5250 | 7 | TR | |
| Type | Size | Design | Frequency (MHz) | Finish 7 = Au T = NiSn | Packaging Tape & Reel TR = 3 Kpcs TR/500 = 500 pcs | |

QUALITY INSPECTION

Finished parts are 100% tested for electrical parameters and visual characteristics.

OPERATING TEMPERATURE

-40°C to +85°C

TERMINATION

Finishes available in Ni/Sn, Immersion Sn, Immersion Au and OSP coatings which are compatible with automatic soldering technologies which include reflow, wave soldering, vapor phase and manual.

ORIENTATION IN TAPE

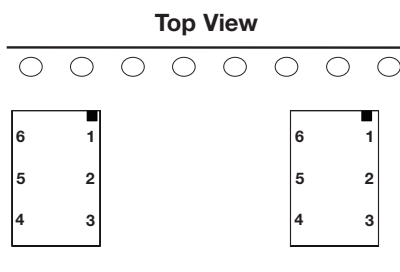

POWER CAPACITY

4.5W Maximum

COMPONENT DIMENSIONS AND FUNCTIONS

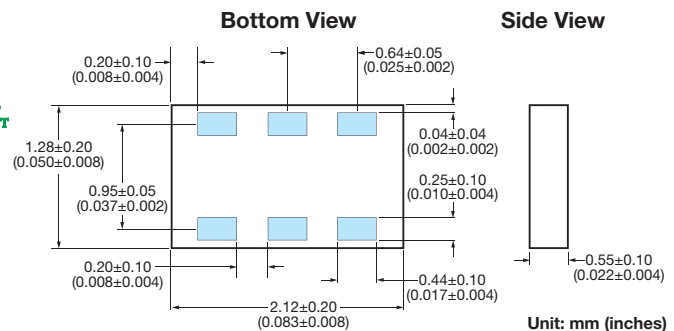

| Terminal No. | Terminal Name |
|--------------|---------------------|
| 1 | High Frequency Port |
| 2 | GND |
| 3 | Low Frequency Port |
| 4 | GND |
| 5 | Common Port |
| 6 | GND |

PART NUMBER: DP05A52507TR

| Specification @ 25°C | |
|----------------------------------|-----------------------------|
| Size [mm(inches)] | 2.12 x 1.28 (0.083 x 0.050) |
| Height [mm(inches)] | 0.55 (0.021) |
| Volume (mm^3) | 1.5 |
| Frequency Range (F1) (MHz) | 2450±50 |
| Frequency Range (F2) (MHz) | 5250±100 |
| Insertion Loss (F1) (dB) | -0.5 |
| Insertion Loss (F2) (dB) | -0.5 |
| Attenuation (F1) at (F2) (dB) | -20 |
| Attenuation (F2) at (F1) (dB) | -20 |
| Return Loss (Lowband @ F1) (dB) | -12 |
| Return Loss (Highband @ F2) (dB) | -12 |
| Isolation (Lowband @ F1) (dB) | -25 |
| Isolation (Highband @ F2) (dB) | -21 |

S PARAMETER MEASUREMENTS

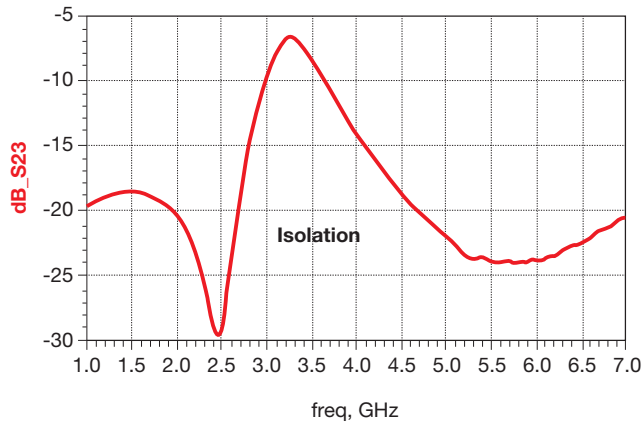
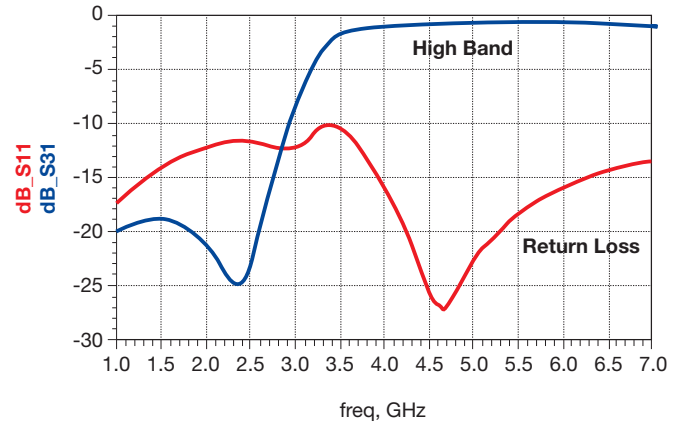
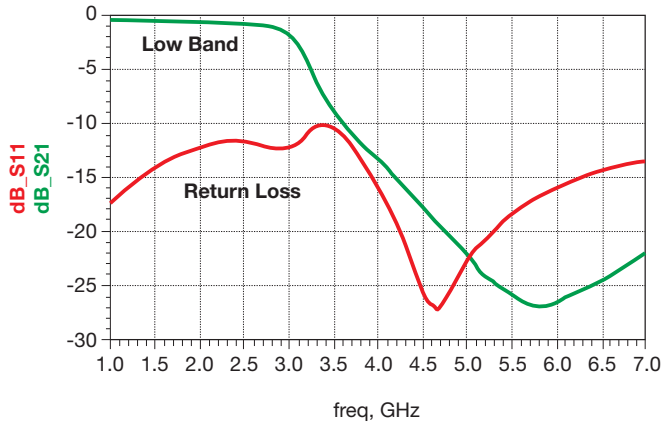

6

Multilayer Organic (MLO™)



0805 WLAN/BT Diplexer



MLO™ TECHNOLOGY

The 0805 MLO™ diplexer is best in class low profile multilayer organic passive device that is based on AVX's patented multilayer organic high density interconnect technology. The MLO™ diplexer uses high dielectric constant and low loss materials to realize high Q passive printed elements such as inductors and capacitors in a multilayer stack up. The MLO™ diplexers can support multiple wireless standards such as WCDMA, CDMA, WLAN and GSM. These components which are less than 0.5mm in thickness are ideally suited for band switching for dual band systems. All MLO™ diplexers are expansion matched to FR4 thereby resulting in improved reliability over standard Si and ceramic devices.

APPLICATIONS

Multiband applications including WiFi, BT, WiMax, GPS, and cellular bands

LAND GRID ARRAY ADVANTAGES

- Low Insertion Loss
- Excellent Solderability
- Low Parasitics
- Matched CTE to PCB

HOW TO ORDER

DP **05** **B** **5425** **7** **TR**
 Type Size Design Frequency (MHz) Finish Packaging
 7 = Au TR = 3 Kpcs
 T = NiSn TR/500 = 500 pcs



COMPONENT DIMENSIONS AND FUNCTIONS

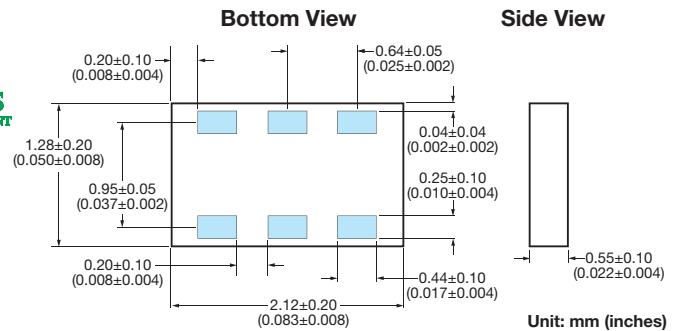

QUALITY INSPECTION

Finished parts are 100% tested for electrical parameters and visual characteristics.

OPERATING TEMPERATURE

-40°C to +85°C

TERMINATION

Finishes available in Ni/Sn, Immersion Sn, Immersion Au and OSP coatings which are compatible with automatic soldering technologies which include reflow, wave soldering, vapor phase and manual.

| Terminal No. | Terminal Name |
|--------------|---------------------|
| 1 | Low Frequency Port |
| 2 | GND |
| 3 | High Frequency Port |
| 4 | GND |
| 5 | Common Port |
| 6 | GND |

ORIENTATION IN TAPE

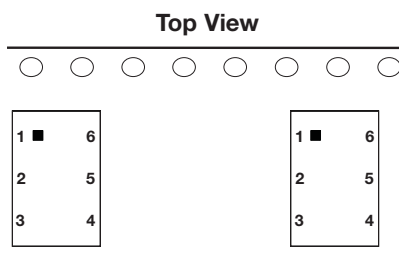

POWER CAPACITY

4.5W Maximum

PART NUMBER: DP05B54257TR

| Specification @ 25°C | |
|---|-----------------------------|
| Size [mm(inches)] | 2.12 x 1.28 (0.083 x 0.050) |
| Height [mm(inches)] | 0.55 (0.021) |
| Volume (mm ³) | 1.5 |
| Pass Band Range (F1) (MHz) | 2450 +/-50MHz |
| Pass Band Range (F2) (MHz) | 5425 +/-525MHz |
| Insertion Loss (F1) (dB) | -0.5 |
| Insertion Loss (F2) (dB) | -1.0 |
| Attenuation (F1) 4800MHz - 6000MHz (dB) | -36 |
| Attenuation 3 x (F1) (dB) | -31 |
| Attenuation (F2) 1800MHz - 2500MHz (dB) | -26 |
| Attenuation 2 x (F2) (dB) | -13 |
| Attenuation 3 x (F2) (dB) | -15 |
| VSWR (Input @ F1) | 1.2 |
| VSWR (Input @ F2) | 1.7 |
| VSWR (Lowband @ F1) | 1.2 |
| VSWR (Highband @ F2) | 1.7 |



S PARAMETER MEASUREMENTS

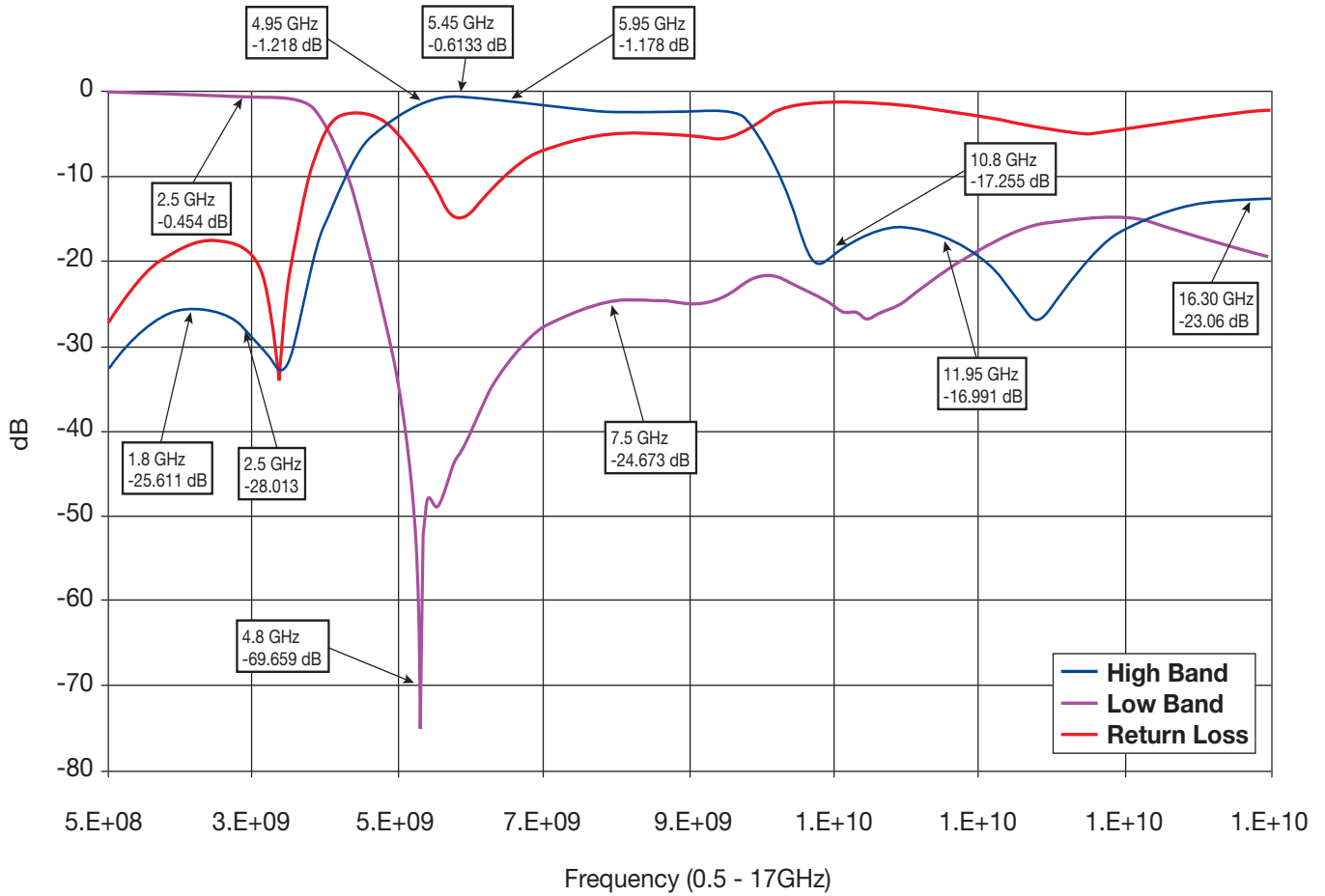

6

AUTOMATED SMT ASSEMBLY

The following section describes the guidelines for automated SMT assembly of MLO™ RF devices which are typically Land Grid Array (LGA) packages or side termination SMT packages. Control of solder and solder paste volume is critical for surface mount assembly of MLO™ RF devices onto the PCB.

Stencil thickness and aperture openings should be adjusted according to the optimal solder volume. The following are general recommendations for SMT mounting of MLO™ devices onto the PCB.

SMT REFLOW PROFILE

Common IR or convection reflow SMT processes shall be used for the assembly. Standard SMT reflow profiles, for eutectic and Pb free solders, can be used to surface mount the MLO™ devices onto the PCB. In all cases, a temperature gradient of 3°C/sec, or less, should be maintained to prevent warpage of the package and to ensure that all joints reflow properly. Additional soak time and slower preheating time

may be required to improve the out-gassing of solder paste. In addition, the reflow profile depends on the PCB density and the type of solder paste used. Standard no-clean solder paste is generally recommended. If another type of flux is used, complete removal of flux residual may be necessary. Example of a typical lead free reflow profile is shown below.

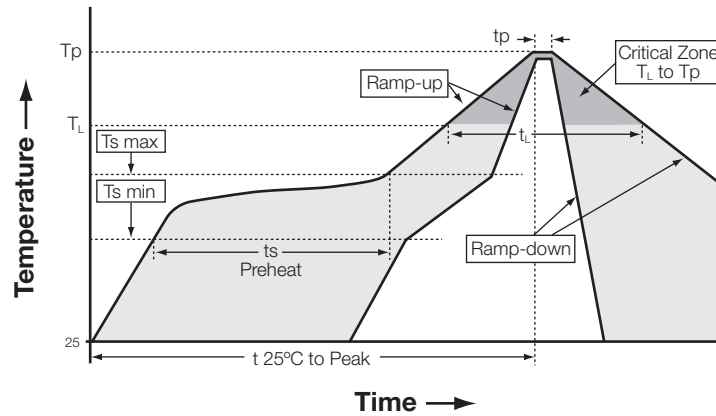

Figure A. Typical Lead Free Profile and Parameters

| Profile Parameter | Pb free, Convection, IR/Convection |
|--|------------------------------------|
| Ramp-up rate (T _s max to T _p) | 3°C/second max. |
| Preheat temperature (T _s min to T _s max) | 150°C to 200°C |
| Preheat time (t _s) | 60 – 180 seconds |
| Time above T _L , 217°C (t _L) | 60 – 120 seconds |
| Peak temperature (T _p) | 260°C |
| Time within 5°C of peak temperature (t _p) | 10 – 20 seconds |
| Ramp-down rate | 4°C/second max. |
| Time 25°C to peak temperature | 6 minutes max. |

MLO™ Tight Tolerance Inductors **AVX RF**



The Multilayer Organic Tight Tolerance Inductor is a low profile organic based inductor that can support mobile communications, satellite applications, GPS, matching networks, and collision avoidance. The MLO™ Tight Tolerance Inductor series of components are based on AVX's patented multilayer organic technology (US patent 6,987,307). MLO™ Tight Tolerance Inductors incorporate very low loss organic materials which allow for high Q and high stability over frequency. MLO™ Tight Tolerance Inductors are surface mountable and are expansion matched to FR4 printed wiring boards. MLO™ Tight Tolerance Inductors utilize fine line high density interconnect technology thereby allowing for tight tolerance control and high repeatability. Reliability testing is performed to JEDEC and mil standards. Finishes are available in RoHS compliant Sn.

APPLICATIONS

- Mobile communications
- Satellite Applications
- GPS
- Collision Avoidance
- Wireless LAN's

FEATURES

- Tight Tolerance
- High Frequency
- High Withstanding Voltage
- Low DC Resistance
- Surface Mountable
- 0402 Case Size
- RoHS Compliant Finishes
- Available in Tape and Reel

SURFACE MOUNT ADVANTAGES

- Inherent Low Profile
- Excellent Solderability
- Low Parasitics
- Better Heat Dissipation
- Expansion Matched to PCB

HOW TO ORDER

| | | | | | |
|---|-------------------------------------|---|--|---------------------------------------|---|
| HL Style Tight Tolerance | 02 Size 02 = 0402 | XXX Inductance Expressed in nH (2 significant digits + number of zeros) for values <10nH, letter R denotes decimal point. Example: 22nH = 220 4.7nH = 4R7 | X Tolerance A = ±0.05nH B = ±0.1nH G = ±2% | T Termination Sn100 | TR Packaging 5000pcs T&R |
|---|-------------------------------------|---|--|---------------------------------------|---|



DIMENSIONS

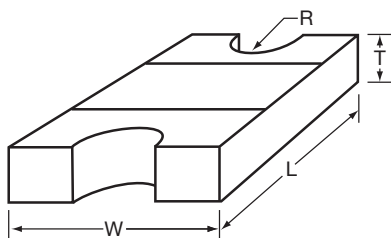

mm (inches)

| L | W | T | R |
|----------------------------|-----------------------------|----------------------------|------------------------------|
| 1.00±0.10 (0.040±0.004) | 0.58±0.075 (0.023±0.003) | 0.35±0.10 (0.014±0.004) | 0.125±0.050 (0.005±0.002) |

QUALITY INSPECTION

Finished parts are 100% tested for electrical parameters and visual characteristics.

TERMINATION

RoHS compliant Sn finish.

OPERATING TEMPERATURE

-55°C to +125°C



0402 ELECTRICAL SPECIFICATIONS

| L (nH) 450MHz | Available Inductance Tolerance A = ±0.05nH, B = ±0.1nH G = ±2% | Q 450MHz | Idc max (mA) | Rdc max (mΩ) | SRF min (GHz) |
|------------------|---|-------------|-----------------|-----------------|------------------|
| 0.8 | ±0.05nH, ±0.1nH | 15 | 450 | 100 | 7 |
| 0.9 | ±0.05nH, ±0.1nH | 15 | 450 | 100 | 7 |
| 1 | ±0.05nH, ±0.1nH | 15 | 420 | 100 | 7 |
| 1.1 | ±0.05nH, ±0.1nH | 15 | 410 | 100 | 7 |
| 1.2 | ±0.05nH, ±0.1nH | 15 | 410 | 110 | 7 |
| 1.3 | ±0.05nH, ±0.1nH | 15 | 295 | 13 | 7 |
| 1.5 | ±0.05nH, ±0.1nH | 15 | 295 | 150 | 7 |
| 1.6 | ±0.05nH, ±0.1nH | 15 | 230 | 150 | 7 |
| 1.8 | ±0.05nH, ±0.1nH | 15 | 295 | 160 | 7 |
| 2 | ±0.05nH, ±0.1nH | 15 | 230 | 18 | 7 |
| 2.2 | ±0.05nH, ±0.1nH | 15 | 230 | 200 | 7 |
| 2.4 | ±0.05nH, ±0.1nH | 15 | 230 | 200 | 7 |
| 2.7 | ±0.05nH, ±0.1nH | 15 | 230 | 250 | 7 |
| 3 | ±0.05nH, ±0.1nH | 15 | 200 | 300 | 7 |
| 3.3 | ±0.05nH, ±0.1nH | 15 | 200 | 340 | 7 |
| 3.6 | ±0.05nH, ±0.1nH | 15 | 180 | 350 | 7 |
| 3.9 | ±0.05nH, ±0.1nH | 15 | 180 | 400 | 7 |
| 4.7 | ±0.1nH | 15 | 170 | 480 | 7 |
| 5.6 | ±0.1nH | 15 | 150 | 500 | 7 |
| 6.8 | ±0.1nH | 15 | 140 | 600 | 7 |
| 8.2 | ±0.1nH | 15 | 115 | 800 | 6 |
| 10 | ±2% | 15 | 105 | 1000 | 5 |
| 12 | ±2% | 15 | 95 | 1100 | 4 |
| 15 | ±2% | 15 | 95 | 1200 | 4 |
| 18 | ±2% | 15 | 85 | 1500 | 3 |
| 22 | ±2% | 15 | 75 | 1900 | 3 |
| 27 | ±2% | 15 | 75 | 2100 | 3 |
| 30 | ±2% | 15 | 65 | 2200 | 2 |
| 32 | ±2% | 15 | 65 | 2200 | 2 |

Specifications based on performance of component assembled properly on printed circuit board with 50Ω nominal impedance.



The Multilayer Organic High Current Inductor is a low profile organic based inductor that can support mobile communications, satellite applications, GPS, matching networks, and collision avoidance. Based on AVX's patented multilayer organic technology (US patent 6,987,307), the 0402 size Multilayer Organic High Current Inductor allows for much higher current handling over similar multilayer ceramic chip inductors, a 50% average increase in current handling over comparable thin film products with similar Q, and current handling approaching that of wire wound ceramic chip inductors. MLO™ High Current Inductors incorporate very low loss organic materials which allow for high Q and high stability over frequency. They are surface mountable and are expansion matched to FR4 printed wiring boards. MLO™ High Current Inductors utilize fine line high density interconnect technology thereby allowing for tight tolerance control and high repeatability. Reliability testing is performed to JEDEC and mil standards. Finishes are available in RoHS compliant Sn.

APPLICATIONS

- Mobile communications
- Satellite Applications
- GPS
- Collision Avoidance
- Wireless LAN's

FEATURES

- High Q
- High SRF
- High Frequency
- High Current Handling
- Low DC Resistance
- Surface Mountable
- 0402 Case Size
- RoHS Compliant Finishes
- Available in Tape and Reel

SURFACE MOUNT ADVANTAGES

- Inherent Low Profile
- Excellent Solderability
- Low Parasitics
- Better Heat Dissipation
- Expansion Matched to PCB

HOW TO ORDER

| | | | | | | |
|--------------------|-----------|--|---|-------------|-------------|--|
| HLC | 02 | XXX | X | T | TR | |
| Type | Size | Inductance | Tolerance | Termination | Packaging | |
| HLC = High Current | 02 = 0402 | Expressed in nH (2 significant digits + number of zeros) for values <10nH, letter R denotes decimal point. Example: 22nH = 220 4.7nH = 4R7 | B = ±0.1nH C = ±0.2nH D = ±0.5nH G = ±2% H = ±3% J = ±5% | Sn100 | 5000pcs T&R | |

DIMENSIONS

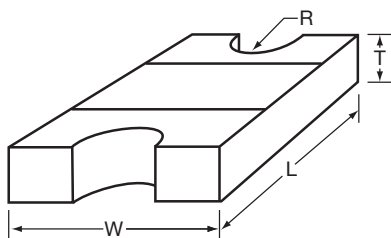

mm (inches)

| L | W | T | R |
|----------------------------|-----------------------------|----------------------------|------------------------------|
| 1.00±0.10 (0.040±0.004) | 0.58±0.075 (0.023±0.003) | 0.35±0.10 (0.014±0.004) | 0.125±0.050 (0.005±0.002) |

QUALITY INSPECTION

Finished parts are 100% tested for electrical parameters and visual characteristics.

TERMINATION

RoHS compliant Sn finish.

OPERATING TEMPERATURE

-55°C to +125°C

0402 ELECTRICAL SPECIFICATIONS

| 450 MHz Test Frequency | | | 900 MHz Test Frequency | | 1900 MHz Test Frequency | | 2400 MHz Test Frequency | | SRF Min (GHz) | Rdc Max (mΩ) | Idc Max (mA) |
|---------------------------|--|--------------|---------------------------|--------------|----------------------------|---------------|----------------------------|---------------|------------------|-----------------|-----------------|
| L (nH) 450 MHz | Available Inductance Tolerance B = ±0.1nH, C = ±0.2nH D = ±0.5nH, G = ±2% H = ±3%, J = ±5% | Q 450 MHz | L (nH) 900 MHz | Q 900 MHz | L (nH) 1900 MHz | Q 1900 MHz | L (nH) 2400 MHz | Q 2400 MHz | | | |
| 0.8 | ±0.1nH, ±0.2nH, ±0.5nH | 30 | 0.8 | 42 | 0.8 | 55 | 0.8 | 61 | >20 | 100 | 875 |
| 0.9 | ±0.1nH, ±0.2nH, ±0.5nH | 26 | 0.9 | 36 | 0.9 | 47 | 0.9 | 52 | >20 | 100 | 835 |
| 1 | ±0.1nH, ±0.2nH, ±0.5nH | 25 | 1.0 | 34 | 1.0 | 45 | 1.0 | 50 | >20 | 100 | 800 |
| 1.1 | ±0.1nH, ±0.2nH, ±0.5nH | 24 | 1.1 | 33 | 1.1 | 43 | 1.1 | 48 | 20 | 100 | 782 |
| 1.2 | ±0.1nH, ±0.2nH, ±0.5nH | 24 | 1.2 | 33 | 1.2 | 44 | 1.2 | 48 | 20 | 110 | 751 |
| 1.3 | ±0.1nH, ±0.2nH, ±0.5nH | 25 | 1.3 | 34 | 1.3 | 44 | 1.3 | 49 | 19 | 130 | 725 |
| 1.5 | ±0.1nH, ±0.2nH, ±0.5nH | 25 | 1.5 | 35 | 1.5 | 45 | 1.5 | 50 | 19 | 150 | 679 |
| 1.6 | ±0.1nH, ±0.2nH, ±0.5nH | 25 | 1.6 | 35 | 1.6 | 45 | 1.6 | 49 | 18 | 150 | 660 |
| 1.8 | ±0.1nH, ±0.2nH, ±0.5nH | 25 | 1.8 | 35 | 1.8 | 45 | 1.8 | 49 | 18 | 160 | 626 |
| 2 | ±0.1nH, ±0.2nH, ±0.5nH | 26 | 2.0 | 35 | 2.0 | 45 | 2.1 | 49 | 17 | 180 | 596 |
| 2.2 | ±0.1nH, ±0.2nH, ±0.5nH | 27 | 2.2 | 36 | 2.2 | 46 | 2.2 | 50 | 16 | 200 | 571 |
| 2.4 | ±0.1nH, ±0.2nH, ±0.5nH | 27 | 2.4 | 37 | 2.4 | 47 | 2.4 | 50 | 15 | 200 | 549 |
| 2.7 | ±0.1nH, ±0.2nH, ±0.5nH | 27 | 2.7 | 36 | 2.7 | 46 | 2.7 | 48 | 14 | 250 | 521 |
| 3 | ±0.1nH, ±0.2nH, ±0.5nH | 27 | 3.0 | 36 | 3.0 | 44 | 3.1 | 46 | 12 | 300 | 497 |
| 3.3 | ±0.1nH, ±0.2nH, ±0.5nH | 27 | 3.3 | 36 | 3.3 | 44 | 3.4 | 46 | 11 | 340 | 476 |
| 3.6 | ±0.1nH, ±0.2nH, ±0.5nH | 27 | 3.6 | 37 | 3.7 | 45 | 3.8 | 46 | 10 | 350 | 457 |
| 3.9 | ±0.1nH, ±0.2nH, ±0.5nH | 28 | 3.9 | 38 | 4.0 | 46 | 4.1 | 47 | 10 | 400 | 441 |
| 4.7 | ±0.1nH, ±0.2nH, ±0.5nH | 29 | 4.7 | 39 | 4.9 | 45 | 5.1 | 44 | 9 | 480 | 405 |
| 5.6 | ±0.1nH, ±0.2nH, ±0.5nH | 30 | 5.7 | 40 | 6.0 | 44 | 6.3 | 42 | 8 | 500 | 375 |
| 6.8 | ±2%, ±3%, ±5% | 30 | 6.9 | 39 | 7.5 | 41 | 8.0 | 37 | 7 | 600 | 343 |
| 8.2 | ±2%, ±3%, ±5% | 29 | 8.4 | 37 | 9.4 | 37 | 10.4 | 31 | 6 | 800 | 315 |
| 10 | ±2%, ±3%, ±5% | 30 | 10.3 | 38 | 12.0 | 35 | 13.9 | 27 | 5 | 1000 | 290 |
| 12 | ±2%, ±3%, ±5% | 32 | 12.5 | 40 | 15.7 | 31 | 19.8 | 19 | 4 | 1100 | 265 |
| 15 | ±2%, ±3%, ±5% | 32 | 15.9 | 38 | 22.3 | 24 | 33.0 | 9 | 4 | 1200 | 240 |
| 18 | ±2%, ±3%, ±5% | 28 | 19.4 | 32 | 31.1 | 15 | 60.0 | 0.3 | 3 | 1500 | 210 |
| 22 | ±2%, ±3%, ±5% | 30 | 24.0 | 34 | 44.7 | 11 | n/a | n/a | 3 | 1900 | 202 |
| 27 | ±2%, ±3%, ±5% | 29 | 30.5 | 30 | n/a | n/a | n/a | n/a | 3 | 2100 | 184 |
| 30 | ±2%, ±3%, ±5% | 28 | 34.0 | 27 | n/a | n/a | n/a | n/a | 2 | 2200 | 180 |
| 32 | ±2%, ±3%, ±5% | 28 | 37.7 | 27 | n/a | n/a | n/a | n/a | 2 | 2200 | 175 |

Specifications based on performance of component assembled properly on printed circuit board with 50Ω nominal impedance.

Idc max: Maximum 15°C rise in component temperature over ambient.



The Multilayer Organic Hi-Q Inductor is a low profile organic based inductor that can support mobile communications, satellite applications, GPS, matching networks, and collision avoidance. The MLO™ Hi-Q Inductor series of components are based on AVX's patented multilayer organic technology (US patent 6,987,307 and 7,439,840). MLO™ Hi-Q Inductors incorporate very low loss organic materials and low profile copper which allow for high Q and high stability over frequency. MLO™ Hi-Q Inductors are surface mountable and are expansion matched to FR4 printed wiring boards. MLO™ Hi-Q Inductors utilize fine line high density interconnect technology thereby allowing for tight tolerance control and high repeatability. Reliability testing is performed to JEDEC and mil standards. Finishes are available in RoHS compliant Sn.

APPLICATIONS

- Mobile communications
- Satellite Applications
- GPS
- Collision Avoidance
- Wireless LAN's

FEATURES

- High Q
- High SRF
- High Frequency
- Low DC Resistance
- Surface Mountable
- 0402 Case Size
- RoHS Compliant Finishes
- Available in Tape and Reel

SURFACE MOUNT ADVANTAGES

- Inherent Low Profile
- Excellent Solderability
- Low Parasitics
- Better Heat Dissipation
- Expansion Matched to PCB

HOW TO ORDER

| | | | | | | |
|--------------|-------------|--|-------------------------------------|--------------------|------------------|--|
| HLQ | 02 | XXX | X | T | TR | |
| | | | | | | |
| Type | Size | Inductance | Tolerance | Termination | Packaging | |
| HLQ = High Q | 02 = 0402 | Expressed in nH (2 significant digits + number of zeros) for values <10nH, letter R denotes decimal point. Example: 22nH = 220 4.7nH = 4R7 | B = ±0.1nH C = ±0.2nH H = ±3% | Sn100 | 5000pcs T&R | |

DIMENSIONS

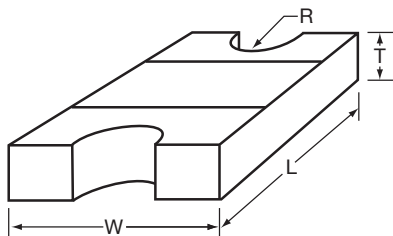

mm (inches)

| L | W | T | R |
|----------------------------|-----------------------------|----------------------------|------------------------------|
| 1.00±0.10 (0.040±0.004) | 0.58±0.075 (0.023±0.003) | 0.35±0.10 (0.014±0.004) | 0.125±0.050 (0.005±0.002) |

QUALITY INSPECTION

Finished parts are 100% tested for electrical parameters and visual characteristics.

TERMINATION

RoHS compliant Sn finish.

OPERATING TEMPERATURE

-55°C to +125°C

0402 ELECTRICAL SPECIFICATIONS

| L (nH) 450MHz | Available Inductance Tolerance B = $\pm 0.1\text{nH}$, C = $\pm 0.2\text{nH}$ H = $\pm 3\%$ | Q min 450MHz | SRF min (GHz) | Rdc max (m Ω) | Idc max (mA) |
|------------------|---|-----------------|------------------|--------------------------|-----------------|
| 0.8 | $\pm 0.1\text{nH}$, $\pm 0.2\text{nH}$ | 17 | 7 | 100 | 350 |
| 0.9 | $\pm 0.1\text{nH}$, $\pm 0.2\text{nH}$ | 17 | 7 | 100 | 350 |
| 1 | $\pm 0.1\text{nH}$, $\pm 0.2\text{nH}$ | 17 | 7 | 100 | 330 |
| 1.1 | $\pm 0.1\text{nH}$, $\pm 0.2\text{nH}$ | 17 | 7 | 100 | 330 |
| 1.2 | $\pm 0.1\text{nH}$, $\pm 0.2\text{nH}$ | 17 | 7 | 110 | 330 |
| 1.3 | $\pm 0.1\text{nH}$, $\pm 0.2\text{nH}$ | 17 | 7 | 130 | 330 |
| 1.5 | $\pm 0.1\text{nH}$, $\pm 0.2\text{nH}$ | 17 | 7 | 150 | 330 |
| 1.6 | $\pm 0.1\text{nH}$, $\pm 0.2\text{nH}$ | 17 | 7 | 150 | 300 |
| 1.8 | $\pm 0.1\text{nH}$, $\pm 0.2\text{nH}$ | 17 | 7 | 160 | 300 |
| 2 | $\pm 0.1\text{nH}$, $\pm 0.2\text{nH}$ | 17 | 7 | 180 | 245 |
| 2.2 | $\pm 0.1\text{nH}$, $\pm 0.2\text{nH}$ | 17 | 7 | 200 | 245 |
| 2.4 | $\pm 0.1\text{nH}$, $\pm 0.2\text{nH}$ | 17 | 7 | 200 | 245 |
| 2.7 | $\pm 0.1\text{nH}$, $\pm 0.2\text{nH}$ | 17 | 7 | 250 | 245 |
| 3 | $\pm 0.1\text{nH}$, $\pm 0.2\text{nH}$ | 17 | 7 | 300 | 225 |
| 3.3 | $\pm 0.1\text{nH}$, $\pm 0.2\text{nH}$ | 17 | 7 | 340 | 225 |
| 3.6 | $\pm 0.1\text{nH}$, $\pm 0.2\text{nH}$ | 17 | 7 | 350 | 200 |
| 3.9 | $\pm 0.1\text{nH}$, $\pm 0.2\text{nH}$ | 17 | 7 | 400 | 200 |
| 4.7 | $\pm 0.1\text{nH}$, $\pm 0.2\text{nH}$ | 17 | 7 | 480 | 195 |
| 5.6 | $\pm 0.1\text{nH}$, $\pm 0.2\text{nH}$ | 17 | 7 | 500 | 170 |
| 6.8 | $\pm 3\%$ | 17 | 7 | 600 | 160 |
| 8.2 | $\pm 3\%$ | 17 | 6 | 800 | 130 |
| 10 | $\pm 3\%$ | 17 | 5 | 1000 | 120 |
| 12 | $\pm 3\%$ | 17 | 4 | 1100 | 110 |
| 15 | $\pm 3\%$ | 17 | 4 | 1200 | 110 |
| 18 | $\pm 3\%$ | 17 | 3 | 1500 | 110 |
| 22 | $\pm 3\%$ | 17 | 3 | 1900 | 95 |
| 27 | $\pm 3\%$ | 17 | 3 | 2100 | 95 |
| 30 | $\pm 3\%$ | 17 | 2 | 2200 | 85 |
| 32 | $\pm 3\%$ | 17 | 2 | 2200 | 85 |

Specifications based on performance of component assembled properly on printed circuit board with 50 Ω nominal impedance.

Idc max: Maximum 15°C rise in component temperature over ambient.

MLO™ INDUCTOR PERFORMANCE CHARACTERISTICS

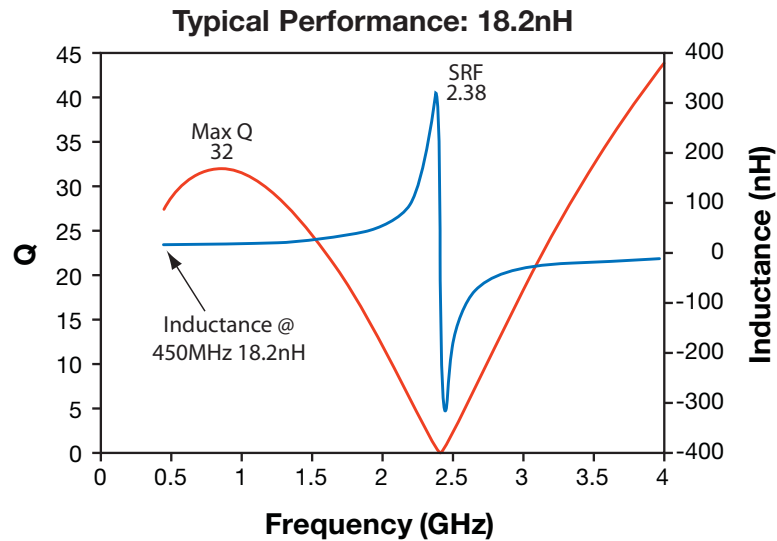
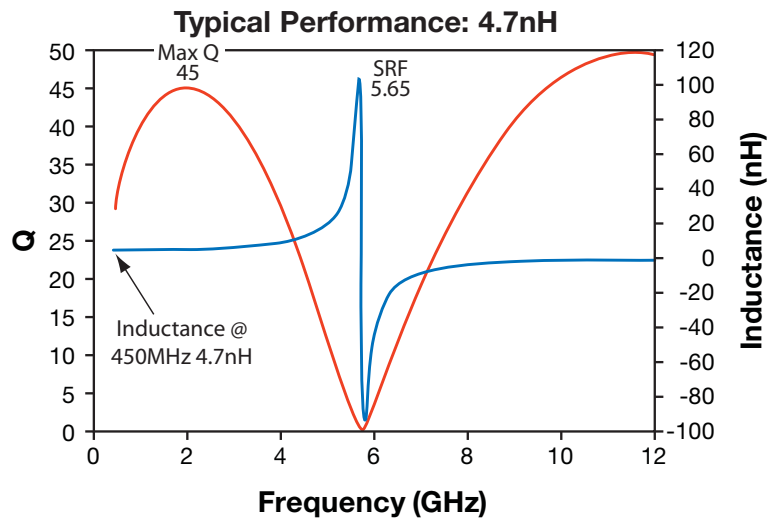
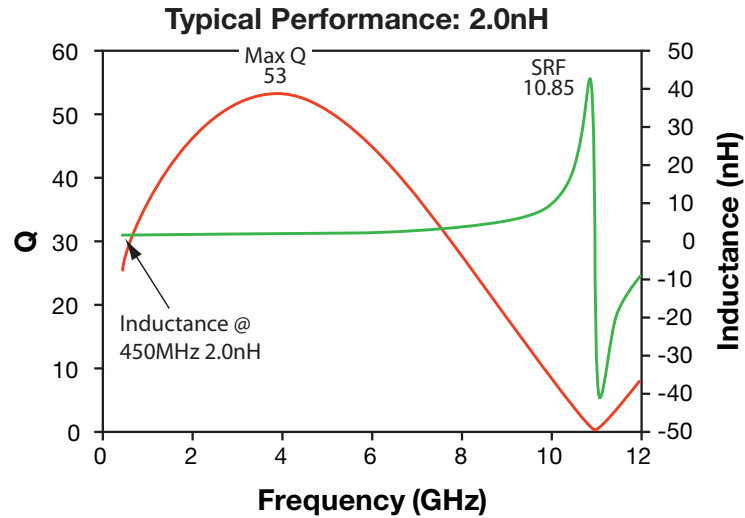

6

AUTOMATED SMT ASSEMBLY

The following section describes the guidelines for automated SMT assembly of MLO™ RF devices which are typically Land Grid Array (LGA) packages or side termination SMT packages. Control of solder and solder paste volume is critical for surface mount assembly of MLO™ RF devices onto the PCB.

Stencil thickness and aperture openings should be adjusted according to the optimal solder volume. The following are general recommendations for SMT mounting of MLO™ devices onto the PCB.

SMT REFLOW PROFILE

Common IR or convection reflow SMT processes shall be used for the assembly. Standard SMT reflow profiles, for eutectic and Pb free solders, can be used to surface mount the MLO™ devices onto the PCB. In all cases, a temperature gradient of 3°C/sec, or less, should be maintained to prevent warpage of the package and to ensure that all joints reflow properly. Additional soak time and slower preheating time

may be required to improve the out-gassing of solder paste. In addition, the reflow profile depends on the PCB density and the type of solder paste used. Standard no-clean solder paste is generally recommended. If another type of flux is used, complete removal of flux residual may be necessary. Example of a typical lead free reflow profile is shown below.

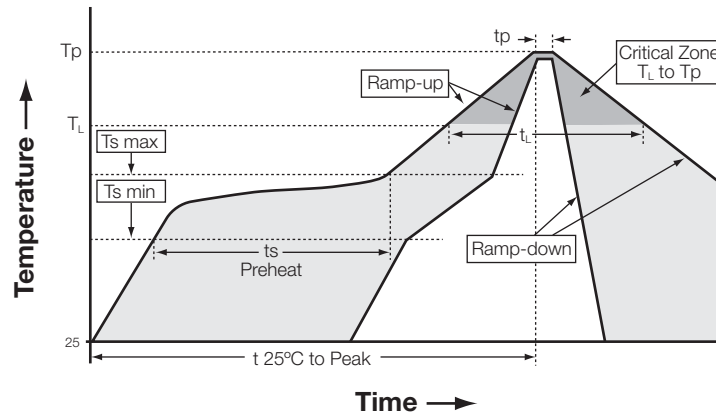
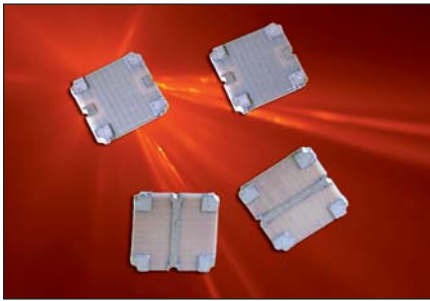

Figure A. Typical Lead Free Profile and Parameters

| Profile Parameter | Pb free, Convection, IR/Convection |
|--|------------------------------------|
| Ramp-up rate (T _s max to T _p) | 3°C/second max. |
| Preheat temperature (T _s min to T _s max) | 150°C to 200°C |
| Preheat time (t _s) | 60 – 180 seconds |
| Time above T _L , 217°C (t _L) | 60 – 120 seconds |
| Peak temperature (T _p) | 260°C |
| Time within 5°C of peak temperature (t _p) | 10 – 20 seconds |
| Ramp-down rate | 4°C/second max. |
| Time 25°C to peak temperature | 6 minutes max. |



GENERAL DESCRIPTION

The MLO™ SMT RF-DC Crossover is a very low profile crossover that intersects an RF and DC circuit trace in an SMT package. The RF-DC Crossover is a low cost solution for applications where a critical RF circuit trace intersects a DC circuit precluding the need for an expensive multilayer printed circuit board. The SMT package can support frequencies up to 6 GHz. MLO™ crossovers have been subjected to JEDEC reliability standards and 100% electrically tested. The RF-DC crossovers are available in NiSn.

FEATURES

- DC – 6.0 GHz
- RF – DC Crossover
- Low Loss
- DC Isolation
- Surface Mountable
- Tape and Reel
- 100% Tested

APPLICATIONS

- Mobile communications
- GPS
- Vehicle location systems
- Wireless LAN's

LAND GRID ARRAY ADVANTAGES

- Inherent Low Profile
- Excellent Solderability
- Low Parasitics
- Better Heat Dissipation

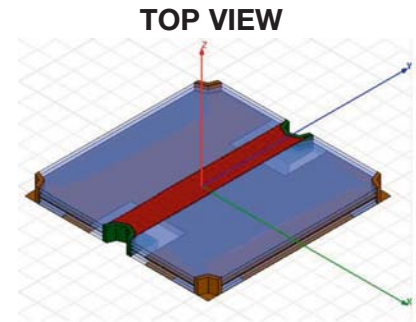

HOW TO ORDER

X2A

Series

2020

Size

RFDC

Type

T

Packaging

T = 1000pcs T&R
T/250 = 250pcs T&R
B = Bulk



| Frequency (GHz) | Port Impedance (ohms) | Ins. Loss (dB max) | Return Loss (dB min) | Power (Watts) | θJC (°C /Watts) | Operating Temperature (°C) |
|-----------------|-----------------------|--------------------|----------------------|---------------|-----------------|----------------------------|
| DC -2.5 | 50 | 0.05 | 20 | 30 | 140 | -55 to +85 |
| 2.5 – 4.0 | 50 | 0.10 | 20 | 19 | 140 | -55 to +85 |
| 4.0 – 6.0 | 50 | 0.15 | 15 | 9 | 140 | -55 to +85 |

* Specification based on performance of component assembled properly on printed circuit board with 50Ω nominal impedance.

6

QUALITY INSPECTION

Finished parts are 100% tested for electrical parameters and visual characteristics.

TERMINATION

NiSn compatible with automatic soldering technologies: Pb free reflow, wave soldering, vapor phase and manual.

OPERATING TEMPERATURE

- 55°C to +85°C

MECHANICAL OUTLINE

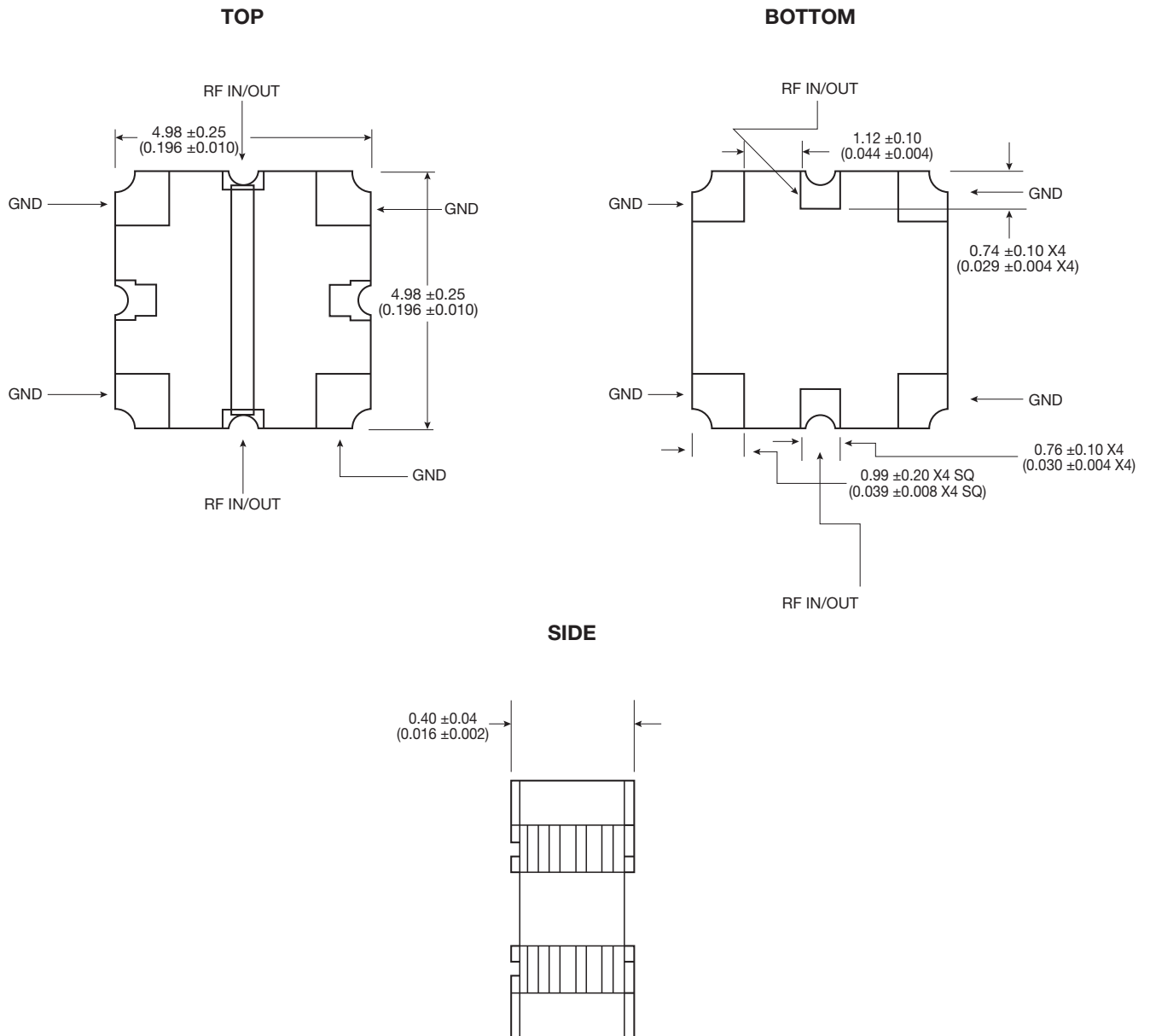

RF-DC SMT CROSSOVER PERFORMANCE: 0.3 GHz TO 6 GHz

RF/DC Crossover – Insertion Loss

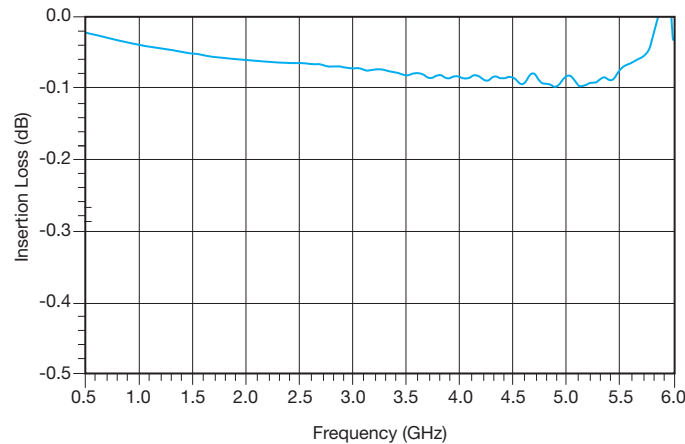

RF/DC Crossover – Return Loss

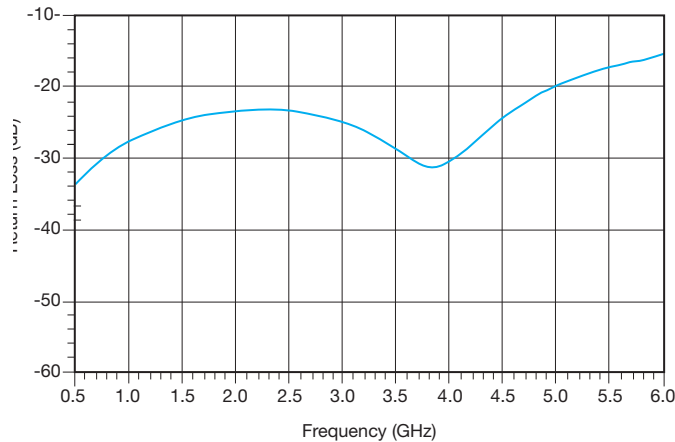

MOUNTING PROCEDURE

MLO™ SMT crossovers require 50Ω transmission lines leading to and from all of the RF ports. Proper grounding is required in order to ensure optimal device performance. If these conditions are not met then performance parameters including insertion loss, return loss and any isolation may not meet published values. All of the MLO™ components utilize castellated interconnects which allow for high yield assembly, expansion matched and halogen free dielectric. When mounting the user must be mindful of the following: a) ensure the RF pads of the device are in contact with the circuit trace of the printed circuit board and b) the ground plane of neither the component nor the PCB is in contact with the RF signal. Parts are specifically oriented in the tape and reel.

MOUNTING FOOTPRINT

To ensure proper electrical and thermal performance there must be a ground plane with 100% solder connection underneath the part.

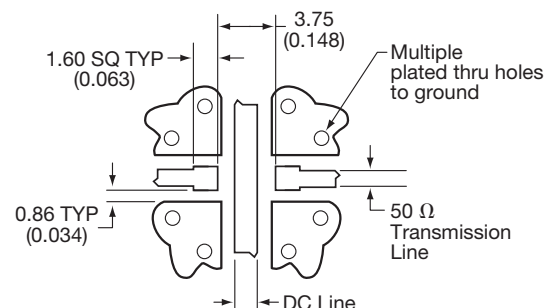
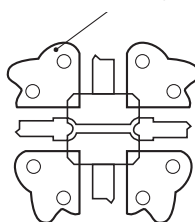

Dimensions are in mm (inches)

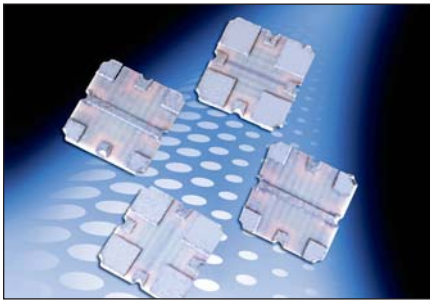

GENERAL DESCRIPTION

The MLO™ SMT RF-RF Crossover is a very low profile crossover that intersects an RF and RF circuit trace in an SMT package. The RF-RF Crossover is a low cost solution for applications where a critical RF circuit trace intersects a RF circuit precluding the need for an expensive multilayer printed circuit board. The SMT package can support frequencies up to 6 GHz. MLO™ crossovers have been subjected to JEDEC reliability standards and 100% electrically tested. The RF-RF crossovers are available in NiSn.

FEATURES

- DC – 6.0 GHz
- RF – RF Crossover
- Low Loss
- High Isolation
- Surface Mountable
- Tape and Reel
- 100% Tested

APPLICATIONS

- Mobile communications
- GPS
- Vehicle location systems
- Wireless LAN's

LAND GRID ARRAY ADVANTAGES

- Inherent Low Profile
- Excellent Solderability
- Low Parasitics
- Better Heat Dissipation

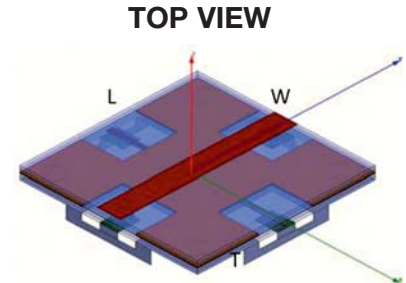

HOW TO ORDER

X2B

Series

2020

Size

RFRF

Type

T

Packaging

T = 1000pcs T&R
T/250 = 250pcs T&R
B = Bulk



| Frequency (GHz) | Port Impedance (ohms) | Ins. Loss (dB max) | Return Loss (dB min) | Isolation (dB min) | Power (Watts) | θJC (°C /Watts) | Operating Temperature (°C) |
|-----------------|-----------------------|--------------------|----------------------|--------------------|---------------|-----------------|----------------------------|
| DC -2.5 | 50 | 0.05 | 20 | 50 | 30 | 150 | -55 to +85 |
| 2.5 – 4.0 | 50 | 0.10 | 18 | 30 | 19 | 150 | -55 to +85 |
| 4.0 – 6.0 | 50 | 0.15 | 10 | 20 | 9 | 150 | -55 to +85 |

* Specification based on performance of component assembled properly on printed circuit board with 50Ω nominal impedance.

QUALITY INSPECTION

Finished parts are 100% tested for electrical parameters and visual characteristics.

TERMINATION

NiSn compatible with automatic soldering technologies: Pb free reflow, wave soldering, vapor phase and manual.

OPERATING TEMPERATURE

- 55°C to +85°C

MECHANICAL OUTLINE

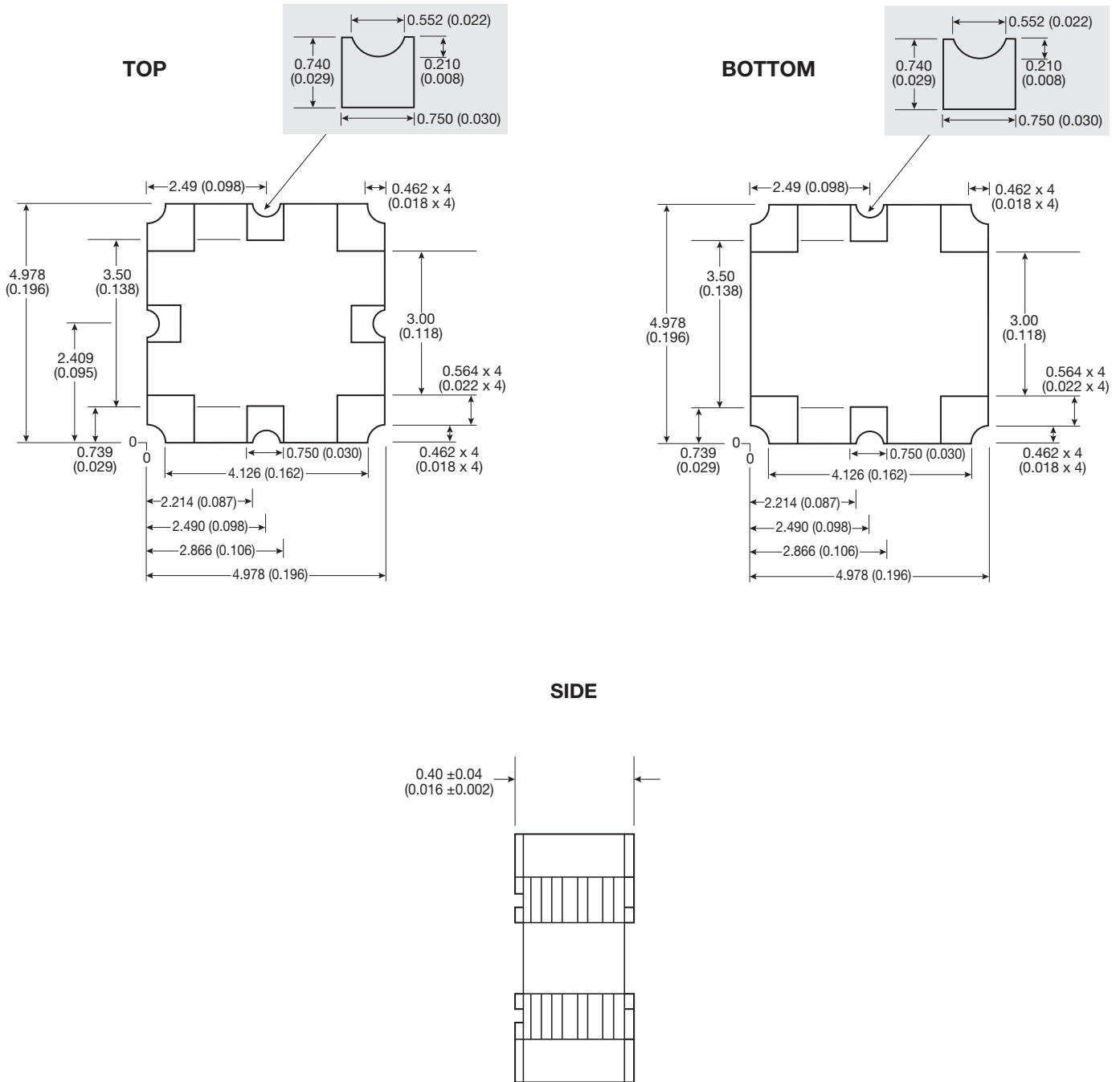

6

RF-RF SMT CROSSOVER PERFORMANCE: 0.3 GHz TO 6 GHz

RF/RF Crossover – Insertion Loss

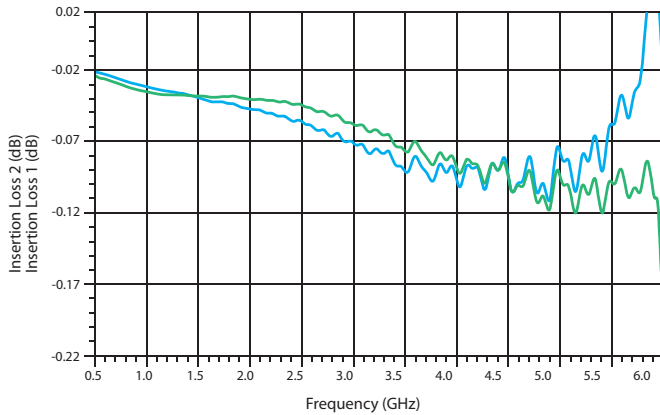

RF/RF Crossover – Return Loss

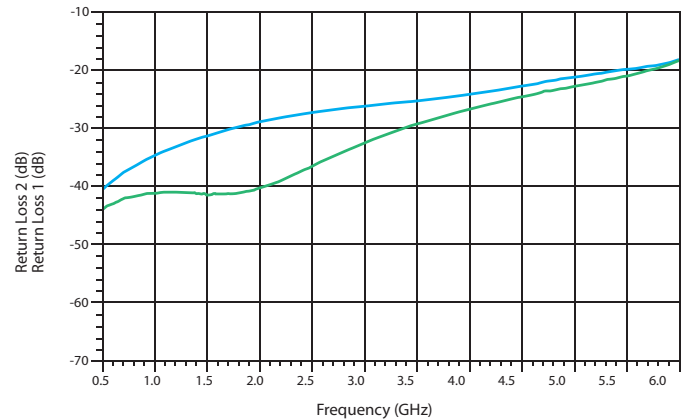

RF/RF Crossover – Isolation

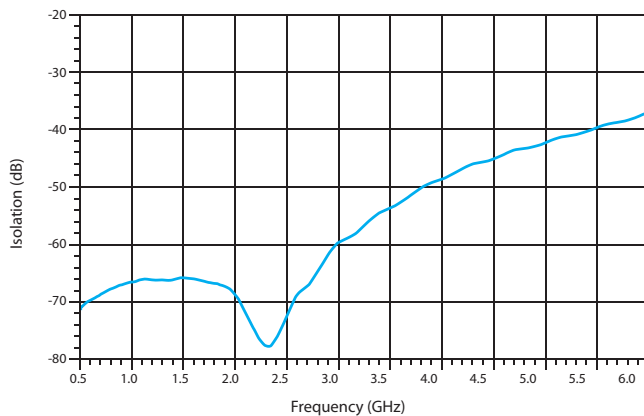

RF/RF Crossover – Phase Balance

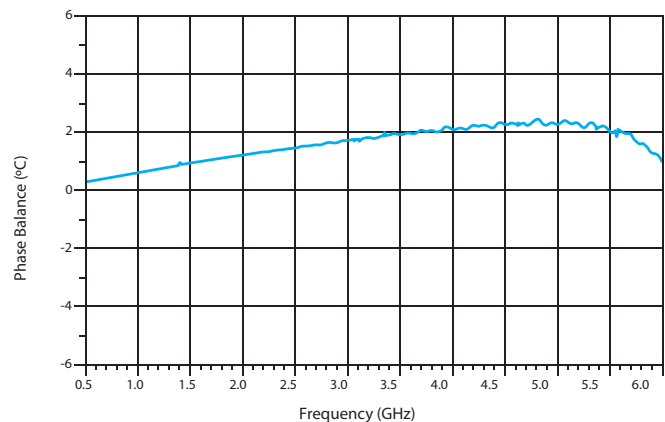

MOUNTING PROCEDURE

MLO™ SMT crossovers require 50Ω transmission lines leading to and from all of the RF ports. Proper grounding is required in order to ensure optimal device performance. If these conditions are not met then performance parameters including insertion loss, return loss and any isolation may not meet published values. All of the MLO™ components utilize castellated interconnects which allow for high yield assembly, expansion matched and halogen free dielectric. When mounting the user must be mindful of the following: a) ensure the RF pads of the device are in contact with the circuit trace of the printed circuit board and b) the ground plane of neither the component nor the PCB is in contact with the RF signal. Parts are specifically oriented in the tape and reel.

MOUNTING FOOTPRINT

To ensure proper electrical and thermal performance there must be a ground plane with 100% solder connection underneath the part.

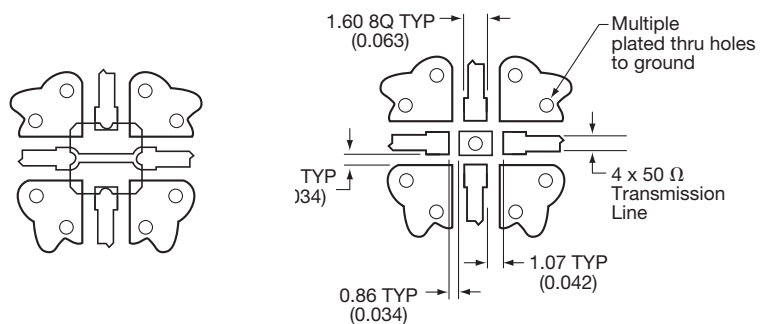

Dimensions are in mm (inches)

AUTOMATED SMT ASSEMBLY

The following section describes the guidelines for automated SMT assembly of MLO™ RF devices which are typically Land Grid Array (LGA) packages or side termination SMT packages.

Control of solder and solder paste volume is critical for

surface mount assembly of MLO™ RF devices onto the PCB. Stencil thickness and aperture openings should be adjusted according to the optimal solder volume. The following are general recommendations for SMT mounting of MLO™ devices onto the PCB.

SMT REFLOW PROFILE

Common IR or convection reflow SMT processes shall be used for the assembly. Standard SMT reflow profiles, for eutectic and Pb free solders, can be used to surface mount the MLO™ devices onto the PCB. In all cases, a temperature gradient of 3°C/sec, or less, should be maintained to prevent warpage of the package and to ensure that all joints reflow properly. Additional soak time and slower preheating time

may be required to improve the out-gassing of solder paste. In addition, the reflow profile depends on the PCB density and the type of solder paste used. Standard no-clean solder paste is generally recommended. If another type of flux is used, complete removal of flux residual may be necessary. Example of a typical lead free reflow profile is shown below:

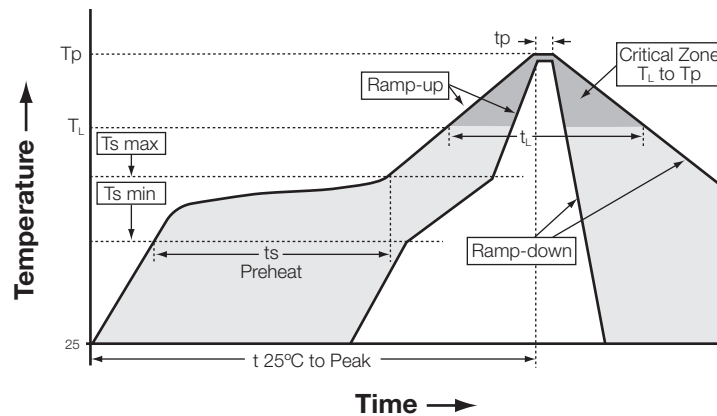

| Profile Parameter | Pb free, Convection, IR/Convection |
|---|------------------------------------|
| Ramp-up rate (Tsmax to Tp) | 3°C/second max. |
| Preheat temperature (Tl min to Tl max) | 150°C to 200°C |
| Preheat time (ts) | 60 – 180 seconds |
| Time above T _L , 217°C (t _L) | 60 – 120 seconds |
| Peak temperature (Tp) | 260°C |
| Time within 5°C of peak temperature (tp) | 10 – 20 seconds |
| Ramp-down rate | 4°C/second max. |
| Time 25°C to peak temperature | 6 minutes max. |

6

AVX RF

RF Inductors

AL Series - Air Core Inductors

AS Series - Square Air Core Inductors

LCWC - Wire Wound Chip Inductors

Air Core RF Inductors



AL Series

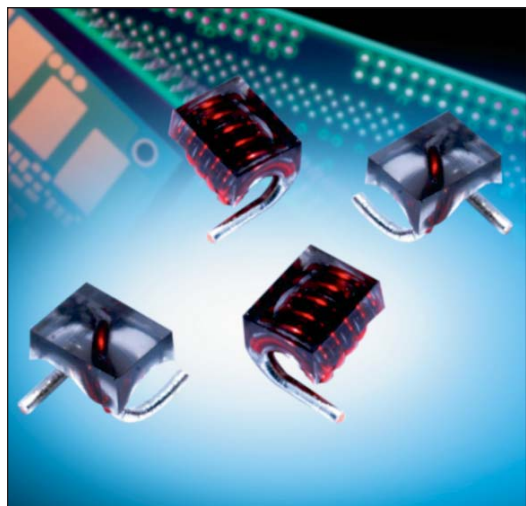

GENERAL DESCRIPTION

AVX Air Core RF Inductors, part of the wound air core inductor family, are ideal for RF circuits, broadband I/O filtering, frequency selection, or impedance matching. The air core inductor provides better performance over solid core inductors with higher Q, and better current handling capabilities.



FEATURES

- Air Core Construction
- High Q
- High Current
- Excellent SRF
- Many inductance values ranging from 1.65nH to 538nH

APPLICATIONS

- RF Applications
- RF Circuits
- Broadband I/O Filtering
- Impedance Matching/Tuning
- Decoupling/Bypassing

HOW TO ORDER

| | | | | | | | |
|--------------------------|--|---|-----------------------------|--|------------------------------|---|---|
| AL └ | 05A └ | 02N5 └ | G └ | T └ | R └ |  |  |
| Air Core Inductor | Size | Inductance | Tolerance | Termination | Packaging | | |
| | Size | 02N5 = 2.5nH 12N5 = 12.5nH 130N = 130nH | G = 2% J = 5% K = 10% | T = Sn/Ag over Cu (96.5% Sn, 3% Ag, 0.5% Cu) | R = 7" reel S = 13" reel* | | |
| | 05A = 0605 05B = 0605 12A = 1212 12B = 1212 016 = 1516 023 = 2523 | | | | *AL016 & AL023 Only | | |

ELECTRICAL SPECIFICATIONS

| | |
|-----------------------|---|
| Technical Data | All technical data related to an ambient temperature of +25°C |
| Inductance Range | 1.65nH to 538nH |
| Inductance Tolerance | 2%, 5%, 10% |
| Rated Current | 1.5A to 4.0A |
| Operating Temperature | -40°C to +125°C |
| Termination | 96.5% Tin/3% Silver over 0.5% Copper |

ELECTRICAL SPECIFICATIONS

| AVX P/N | Turns | Inductance (nH) | Tolerance (%) | Q min. | Q typ. | Test Freq. (MHz) | DCR max (mΩ) | SRF GHz (min.) | Ir max Amps |
|--------------|-------|-----------------|---------------|--------|--------|------------------|--------------|----------------|-------------|
| AL05A1N65KTR | 2 | 1.65 | K | 100 | - | 800 | 4 | 10 | 1.60 |
| AL05A2N55*TR | 3 | 2.55 | J, K | 100 | - | 800 | 5 | 8.2 | 1.60 |
| AL05A3N85*TR | 4 | 3.85 | G, J, K | 100 | - | 800 | 6 | 7.5 | 1.60 |
| AL05A5N45*TR | 5 | 5.45 | G, J | 100 | - | 800 | 8 | 7 | 1.60 |
| AL05B05N6*TR | 6 | 5.6 | G, J | 100 | - | 800 | 9 | 6.5 | 1.60 |
| AL05B7N15*TR | 7 | 7.15 | G, J | 100 | - | 800 | 10 | 6 | 1.60 |
| AL05B08N8*TR | 8 | 8.8 | G, J | 100 | - | 800 | 12 | 6 | 1.60 |
| AL05B9N85*TR | 9 | 9.85 | G, J | 100 | - | 800 | 13 | 5.2 | 1.60 |
| AL05B12N5*TR | 10 | 12.55 | G, J | 100 | - | 800 | 14 | 4.6 | 1.60 |
| AL12A02N5KTR | 1 | 2.5 | K | 145 | - | 150 | 1.1 | 12.5 | 4.00 |
| AL12A05N0*TR | 2 | 5 | J, K | 140 | - | 150 | 1.8 | 6.5 | 4.00 |
| AL12A08N0*TR | 3 | 8 | G, J | 140 | - | 150 | 2.6 | 5 | 4.00 |
| AL12A12N5*TR | 4 | 12.5 | G, J | 137 | - | 150 | 3.4 | 3.3 | 4.00 |
| AL12A18N5*TR | 5 | 18.5 | G, J | 132 | - | 150 | 3.9 | 2.5 | 4.00 |
| AL12B17N5*TR | 6 | 17.5 | G, J | 100 | - | 150 | 4.5 | 2.2 | 4.00 |
| AL12B22N0*TR | 7 | 22 | G, J | 102 | - | 150 | 5.2 | 2.1 | 4.00 |
| AL12B28N0*TR | 8 | 28 | G, J | 105 | - | 150 | 6 | 1.8 | 4.00 |
| AL12B35N5*TR | 9 | 35.5 | G, J | 112 | - | 150 | 6.8 | 1.5 | 4.00 |
| AL12B43N0*TR | 10 | 43 | G, J | 106 | - | 150 | 7.9 | 1.2 | 4.00 |
| AL01622N0*TS | 4 | 22 | G, J | 100 | 135 | 150 | 4.2 | 3.2 | 3.00 |
| AL01627N0*TS | 5 | 27 | G, J | 100 | 135 | 150 | 4 | 2.7 | 3.50 |
| AL01633N0*TS | 5 | 33 | G, J | 100 | 130 | 150 | 4.8 | 2.5 | 3.00 |
| AL01639N0*TS | 6 | 39 | G, J | 100 | 135 | 150 | 4.4 | 2.1 | 3.00 |
| AL01647N0*TS | 6 | 47 | G, J | 100 | 135 | 150 | 5.6 | 2.1 | 3.00 |
| AL01656N0*TS | 7 | 56 | G, J | 100 | 125 | 150 | 6.2 | 1.5 | 3.00 |
| AL01668N0*TS | 7 | 68 | G, J | 100 | 120 | 150 | 8.2 | 1.5 | 2.50 |
| AL01682N0*TS | 8 | 82 | G, J | 100 | 120 | 150 | 9.4 | 1.3 | 2.50 |
| AL016100N*TS | 9 | 100 | G, J | 100 | 115 | 150 | 12.3 | 1.2 | 1.70 |
| AL016120N*TS | 9 | 120 | G, J | 100 | 125 | 150 | 17.3 | 1.1 | 1.50 |
| AL02390N0*TS | 9 | 90 | G, J | 95 | 114 | 50 | 15 | 1.140 | 3.50 |
| AL023111N*TS | 10 | 111 | G, J | 87 | 104 | 50 | 15 | 1.020 | 3.50 |
| AL023130N*TS | 11 | 130 | G, J | 87 | 104 | 50 | 20 | 0.900 | 3.00 |
| AL023169N*TS | 12 | 169 | G, J | 95 | 114 | 50 | 25 | 0.875 | 3.00 |
| AL023206N*TS | 13 | 206 | G, J | 95 | 114 | 50 | 30 | 0.800 | 3.00 |
| AL023222N*TS | 14 | 222 | G, J | 92 | 110 | 50 | 35 | 0.730 | 3.00 |
| AL023246N*TS | 15 | 246 | G, J | 95 | 114 | 50 | 35 | 0.685 | 3.00 |
| AL023307N*TS | 16 | 307 | G, J | 95 | 114 | 50 | 35 | 0.660 | 3.00 |
| AL023380N*TS | 17 | 380 | G, J | 95 | 114 | 50 | 50 | 0.590 | 2.50 |
| AL023422N*TS | 18 | 422 | G, J | 95 | 114 | 50 | 60 | 0.540 | 2.50 |
| AL023491N*TS | 19 | 491 | G, J | 95 | 114 | 50 | 65 | 0.535 | 2.00 |
| AL023538N*TS | 20 | 538 | G, J | 87 | 104 | 50 | 90 | 0.490 | 2.00 |

*Tolerance: G= ± 2%, J: ± 5%, K: ± 10%

a. Test Equipment:

L/Q: HP-4291B With HP16193A test fixture or equivalent.

SRF: HP8753E /HP8720D or equivalent.

RDC: Chroma 16502 or equivalent.

b. Operating temperature range: -40°C to +125°C.

c. For Temperature Rise: 15°C

d. Storage Temp.: -40°C to +85°C.

f. MSL: Level 1

AL Series

PHYSICAL DIMENSIONS

AL12A, AL12B, AL016, AL023

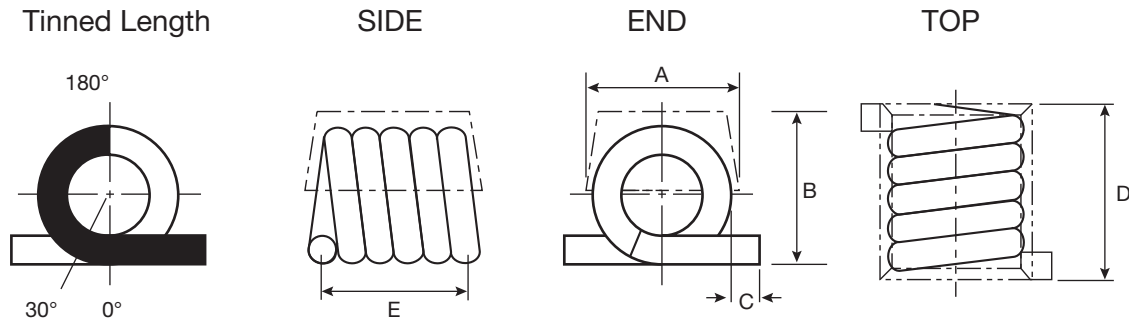

AL05A, AL05B

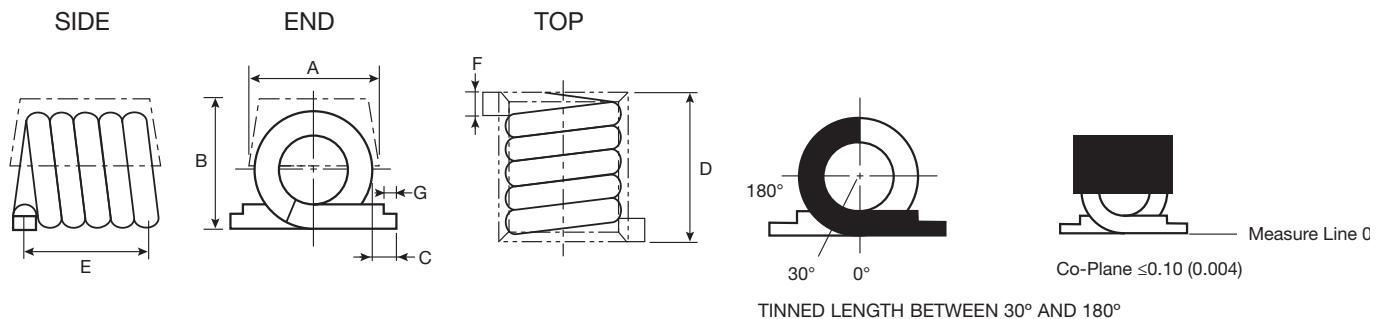

mm (inches)

| Part Number | A | B | C | D | E | F | G |
|-------------|--------------------------------|--------------------------------|--------------------------------|--------------------------------|--------------------------------|---------------------------|---------------------------|
| AL05A | 1.42 ± 0.13 (0.056 ± 0.005) | 1.37 ± 0.15 (0.056 ± 0.005) | 0.89 ± 0.25 (0.035 ± 0.010) | 2.21 ± 0.25 (0.087 ± 0.010) | 1.83 ± 0.25 (0.072 ± 0.010) | 0.51 max. (0.200 max.) | 0.35 min. (0.014 min.) |
| AL05B | 1.42 ± 0.13 (0.056 ± 0.005) | 1.37 ± 0.15 (0.056 ± 0.005) | 0.89 ± 0.25 (0.035 ± 0.010) | 4.04 ± 0.30 (0.159 ± 0.012) | 3.66 ± 0.30 (0.144 ± 0.012) | 0.51 max. 0.200 max. | 0.35 min. 0.014 min. |
| AL12A | 3.05 max. (0.120 max.) | 3.18 max. (0.125 max.) | 0.58 ± 0.38 (0.023 ± 0.015) | 3.68 max. (0.145 max.) | 2.92 ± 0.25 (0.115 ± 0.010) | - | - |
| AL12B | 3.05 max. (0.120 max.) | 3.18 max. (0.125 max.) | 0.58 ± 0.38 (0.023 ± 0.015) | 6.86 max. (0.270 max.) | 5.84 ± 0.25 (0.230 ± 0.010) | - | - |
| AL016 | 3.81 (0.150) | 4.20 max. (0.165 max.) | 1.53 ± 0.39 (0.060 ± 0.015) | 4.83 max. (0.190 max.) | 4.32 ± 0.39 (0.170 ± 0.015) | - | - |
| AL023 | 6.35 max. (0.250 max.) | 5.90 max. (0.232 max.) | 1.02 ± 0.39 (0.040 ± 0.015) | 10.55 max. (0.415 max.) | 7.98 ± 0.51 (0.314 ± 0.020) | - | - |

RECOMMENDED LAND PATTERNS

mm (inches)

| Part Number | A | B | C | D | E |
|-------------|-----------------|-----------------|-----------------|-----------------|-----------------|
| AL05A | 2.62 (0.103) | 2.46 (0.097) | 1.04 (0.041) | 1.02 (0.040) | 0.79 (0.031) |
| AL05B | 4.45 (0.175) | 2.46 (0.097) | 2.87 (0.113) | 1.02 (0.040) | 0.79 (0.031) |
| AL12A | 4.19 (0.165) | 3.30 (0.130) | 1.65 (0.065) | 2.79 (0.110) | 1.27 (0.050) |
| AL12B | 7.24 (0.285) | 3.30 (0.130) | 4.70 (0.185) | 2.79 (0.110) | 1.27 (0.050) |
| AL016 | 5.80 (0.228) | 5.16 (0.203) | 2.85 (0.112) | 2.62 (0.103) | 1.48 (0.058) |
| AL023 | 10.0 (0.394) | 4.70 (0.185) | 5.95 (0.234) | 2.42 (0.095) | 2.04 (0.080) |

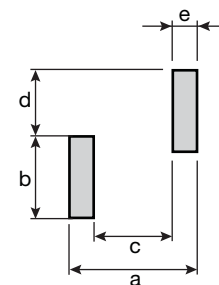

PERFORMANCE SPECIFICATIONS

AL05A

Inductance vs. Frequency

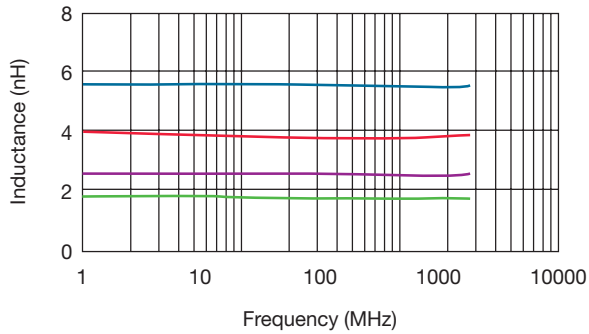

Typical Q vs. Frequency

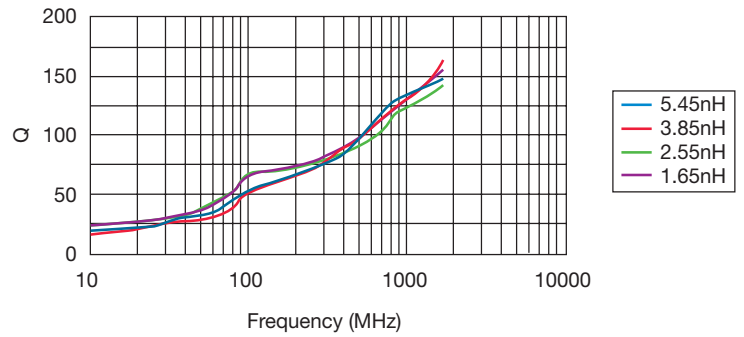

AL05B

Inductance vs. Frequency

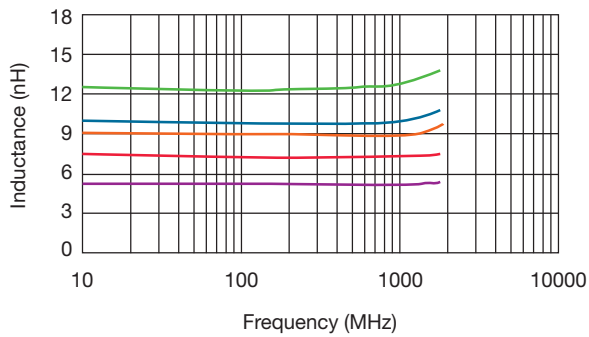

Typical Q vs. Frequency

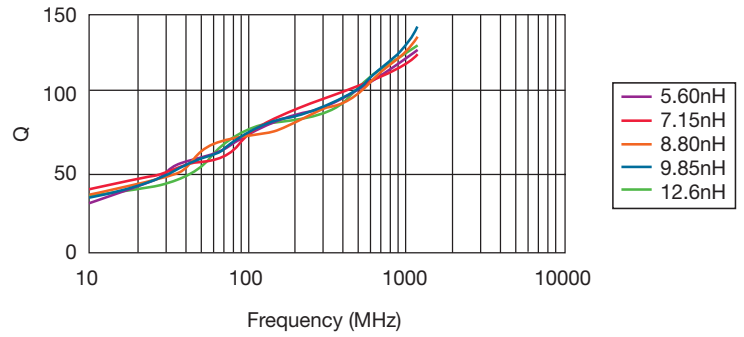

AL12A

Inductance vs. Frequency

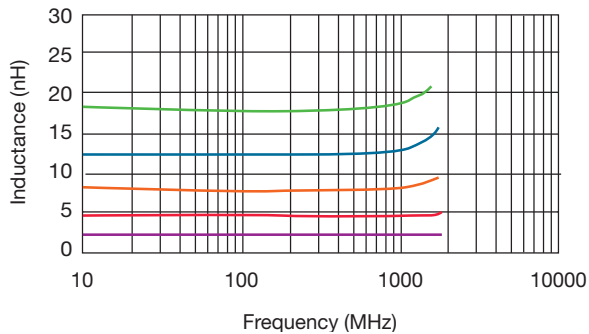

Typical Q vs. Frequency

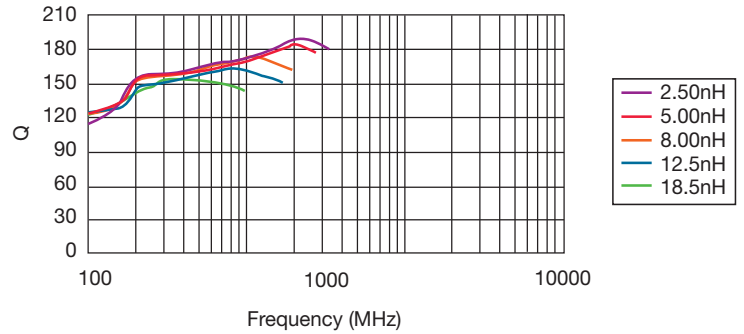

PERFORMANCE SPECIFICATIONS

AL12B

Inductance vs. Frequency

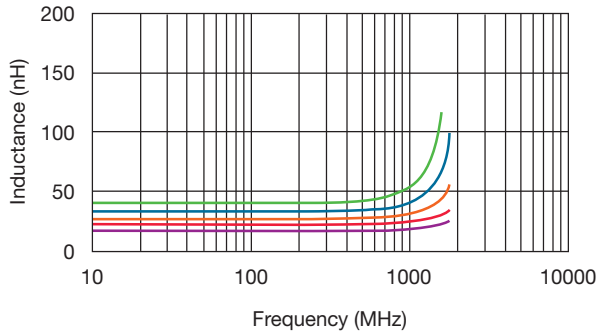

Typical Q vs. Frequency

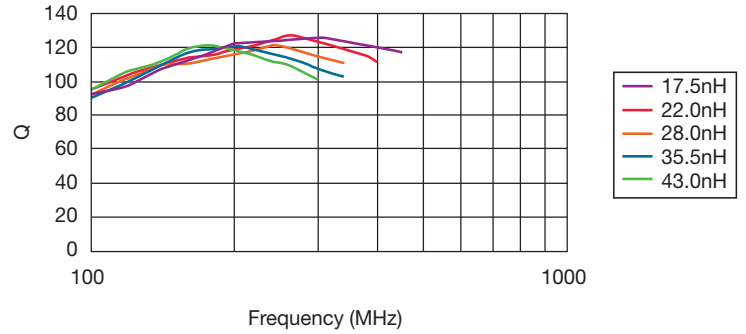

AL016

Inductance vs. Frequency

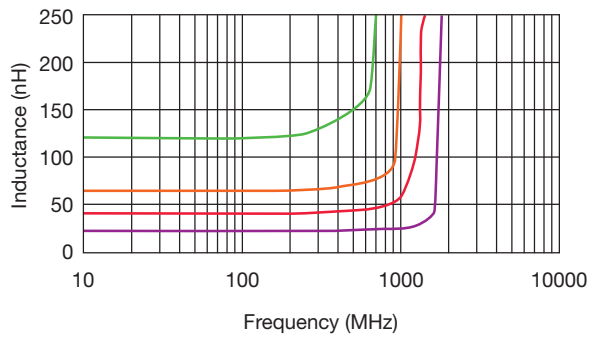

Typical Q vs. Frequency

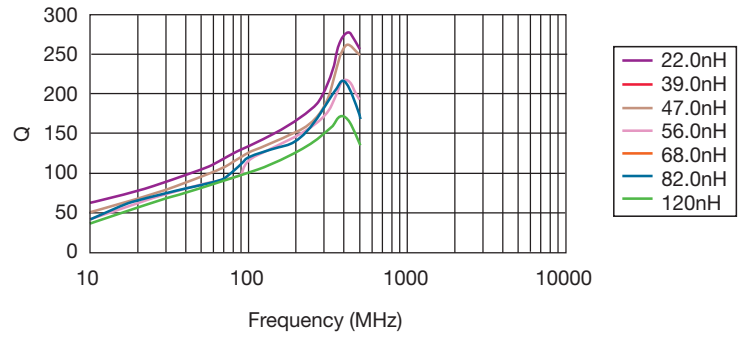

AL023

Inductance vs. Frequency

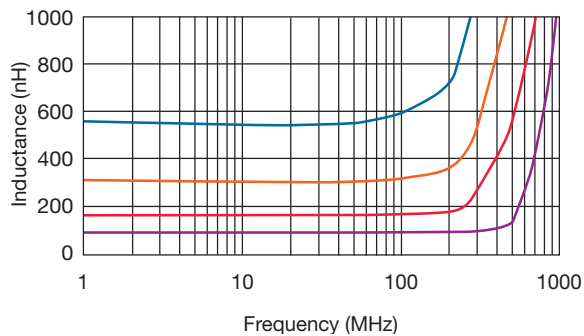

Typical Q vs. Frequency

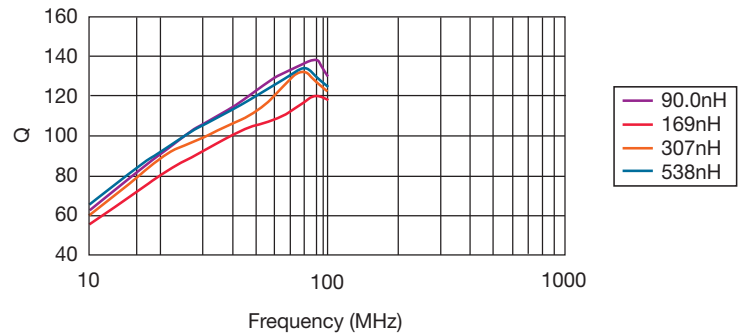

7

TYPICAL RoHS REFLOW PROFILE

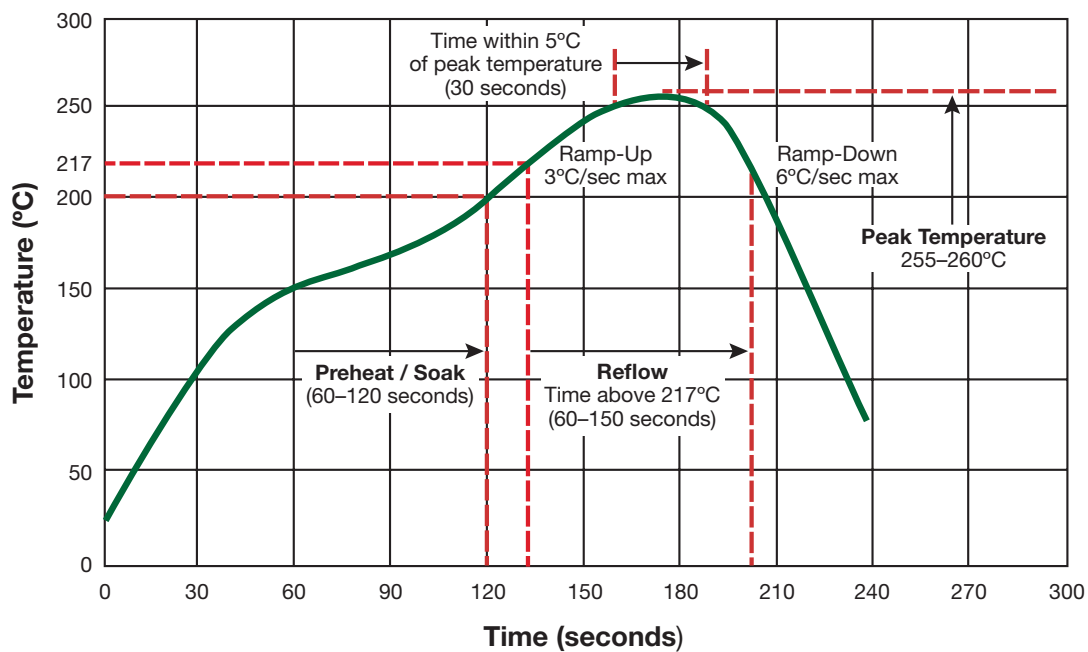

PACKAGING SPECIFICATIONS

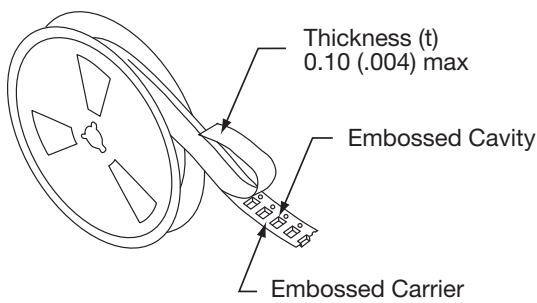

- The force for tearing off cover tape is 10 to 130 grams in the arrow direction

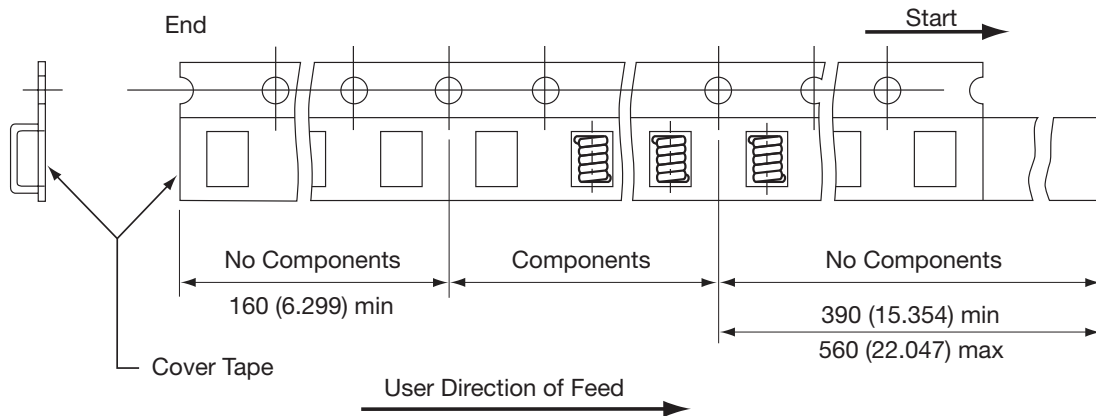
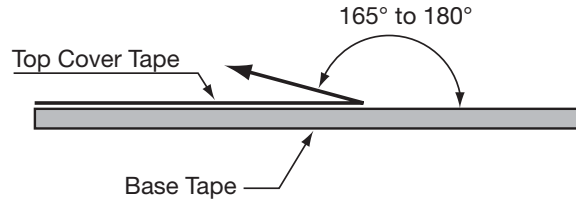

CARRIER TAPE REELS

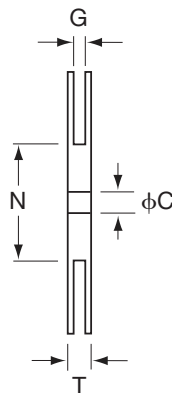
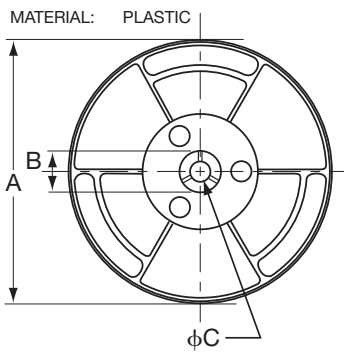

DIMENSIONS OF CARRIER TAPE

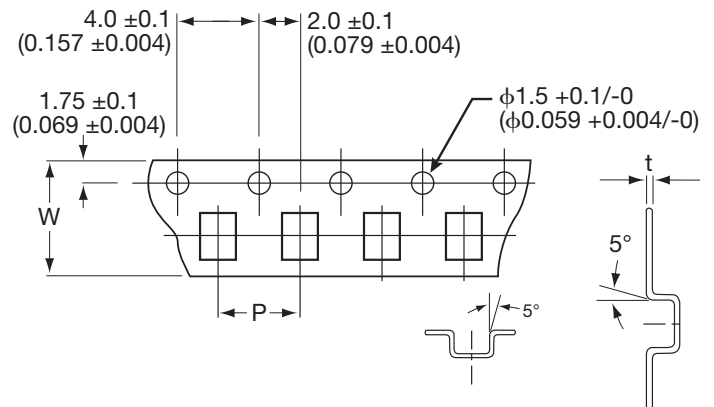

mm (inches)

| Series | ITEM | A | B | C | N | G | T | W | P | t |
|--------|------|-----------|-----------|-----------|-----------|-----------|-----------|------------|------------|------------|
| AL05A | DIM. | 178 | 21 | 13 | 75 | 8.4 | 12.5 | 8 | 4 | 0.30 |
| | TOL. | ± 2.0 | ± 0.8 | ± 0.8 | ± 2.0 | +1.5 | +1.5 | ± 0.3 | ± 0.1 | ± 0.05 |
| AL05B | DIM. | 180 | 21 | 13 | 50 | 12.4 | 18.4 | 12 | 4 | 0.35 |
| | TOL. | MAX | ± 0.8 | +0.5/-0.2 | MIN | +2.0 | MAX | ± 0.30 | ± 0.10 | ± 0.05 |
| AL12A | DIM. | 178 | 25 | 15 | 75 | 12.5 | 16.4 | 12 | 8 | 0.25 |
| | TOL. | ± 2.0 | ± 1.0 | ± 0.5 | ± 2.0 | +1.5 | +1.5 | ± 0.2 | ± 0.1 | ± 0.05 |
| AL12B | DIM. | 178 | 50 | 15 | 75 | 16.5 | 20.4 | 16 | 8 | 0.25 |
| | TOL. | ± 2.0 | ± 1.0 | ± 0.5 | ± 2.0 | +1.5 | +1.5 | ± 0.2 | ± 0.1 | ± 0.05 |
| AL016 | DIM. | 340 | 20.2 | 13 | 100 | 16.5 | 25.5 | 16 | 12 | 0.30 |
| | TOL. | MAX | MIN | ± 0.5 | REF | ± 0.5 | ± 0.5 | ± 0.30 | ± 0.10 | ± 0.05 |
| AL023 | DIM. | 340 | 20.2 | 13 | 100 | 24.5 | 30.4 | 24.0 | 12.0 | 0.35 |
| | TOL. | MAX | MIN | ± 0.5 | REF | ± 0.5 | ± 0.5 | ± 0.30 | ± 0.10 | ± 0.05 |

Square Air Core RF Inductors



AS Series

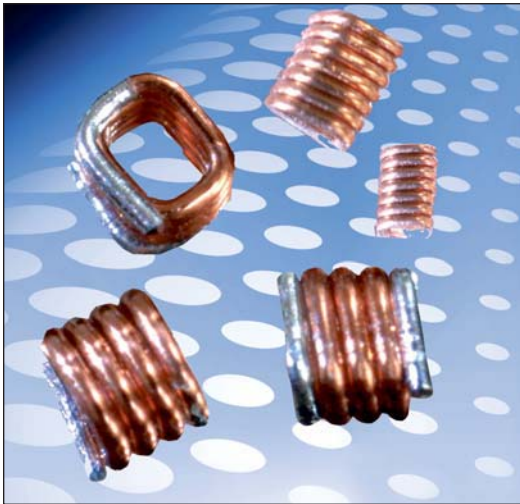

GENERAL DESCRIPTION

AVX Square Air Core RF Inductors, part of the wound air core inductor family, are ideal for RF circuits, broadband I/O filtering, frequency selection, or impedance matching. The unique square cross section of the air core inductor provides better performance, and offers manufacturing advantages over toroidal coils.

FEATURES

- Square cross section construction
- Available in 0806, 0807, and 0908 sizes
- 20 Inductance values ranging from 5.5nH to 27.3nH
- High Q
- High Current
- Excellent SRF

APPLICATIONS

- RF Applications
- RF Circuits
- Broadband I/O Filtering
- Impedance Matching

HOW TO ORDER

| | | | | | |
|--|-------------------------------------|---|-----------------------------|--|---|
| AS ┆ | 06 ┆ | 05N5 ┆ | J ┆ | T ┆ | R ┆ |
| Air Core Inductor (Square Cross Section) | Size Size | Inductance | Tolerance | Termination | Packaging |
| | 06 = 0806 07 = 0807 08 = 0908 | 05N5 = 5.5nH 06N0 = 6.0nH 12N3 = 12.3nH | G = 2% J = 5% K = 10% | T = Sn/Ag over Cu (96.5% Sn, 3% Ag, 0.5% Cu) | R = 7 inch reel (2000 pieces per reel) |



ELECTRICAL SPECIFICATIONS

| | |
|-----------------------|---|
| Technical Data | All technical data related to an ambient temperature of +25°C |
| Inductance Range | 5.5nH to 27.3nH |
| Inductance Tolerance | 2%, 5%, 10% |
| Rated Current | 2.7A, 2.9A, 4.4A |
| Operating Temperature | -40°C to +125°C |
| Termination | 96.5% Tin/3% Silver over 0.5% Copper |

ELECTRICAL SPECIFICATIONS

| AVX P/N | Turns | Inductance (nH) | Tolerance (%) | Q min. | Test Freq. (MHz) | DCR max (mΩ) | SRF (GHz) | I _r max (A) |
|-------------|-------|-----------------|---------------|--------|------------------|--------------|-----------|------------------------|
| AS0605N5*TR | 3 | 5.5 | G, J, K | 60 | 400 | 3.4 | 4.9 | 2.9 |
| AS0606N0*TR | 3 | 6 | G, J, K | 64 | 400 | 6 | 5.2 | 2.9 |
| AS0608N9*TR | 4 | 8.9 | G, J, K | 90 | 400 | 7 | 4.3 | 2.9 |
| AS0612N3*TR | 5 | 12.3 | G, J, K | 90 | 400 | 8 | 4.8 | 2.9 |
| AS0615N7*TR | 6 | 15.7 | G, J, K | 90 | 400 | 9 | 4.4 | 2.9 |
| AS0619N4*TR | 7 | 19.4 | G, J, K | 90 | 400 | 10 | 4 | 2.9 |
| AS0706N9*TR | 3 | 6.9 | G, J, K | 100 | 400 | 6 | 4.6 | 2.7 |
| AS0710N2*TR | 4 | 10.2 | G, J, K | 100 | 400 | 7 | 4 | 2.7 |
| AS0711N2*TR | 4 | 11.2 | G, J, K | 90 | 400 | 6.3 | 3.6 | 2.7 |
| AS0713N7*TR | 5 | 13.7 | G, J, K | 100 | 400 | 8 | 4.3 | 2.7 |
| AS0717N0*TR | 6 | 17 | G, J, K | 100 | 400 | 9 | 4 | 2.7 |
| AS0722N0*TR | 7 | 22 | G, J, K | 100 | 400 | 10 | 3.5 | 2.7 |
| AS0808N1*TR | 3 | 8.1 | G, J, K | 130 | 400 | 6 | 5.2 | 4.4 |
| AS0812N1*TR | 4 | 12.1 | G, J, K | 130 | 400 | 7 | 4.3 | 4.4 |
| AS0814N7*TR | 4 | 14.7 | G, J, K | 90 | 400 | 7.2 | 3 | 4.4 |
| AS0816N6*TR | 5 | 16.6 | G, J, K | 130 | 400 | 8 | 3.4 | 4.4 |
| AS0821N5*TR | 6 | 21.5 | G, J, K | 130 | 400 | 9 | 3.7 | 4.4 |
| AS0823N0*TR | 6 | 23 | G, J, K | 130 | 400 | 10 | 2.6 | 4.4 |
| AS0825N0*TR | 7 | 25 | G, J, K | 130 | 400 | 10 | 2.5 | 4.4 |
| AS0827N3*TR | 7 | 27.3 | G, J, K | 130 | 400 | 10 | 3.2 | 4.4 |

- Note: 1. *Tolerance: G=±2%, J=±5%, K=±10%
 2. Inductance & Q measured on the HP4291B. With HP16193A test fixture.
 3. SRF measured using the HP8753E
 4. Operating Temperature range: -40°C to +125°C
 5. Electrical Specifications at 25°C
 6. MSL: Level 1



Square Air Core RF Inductors



AS Series

PHYSICAL DIMENSIONS

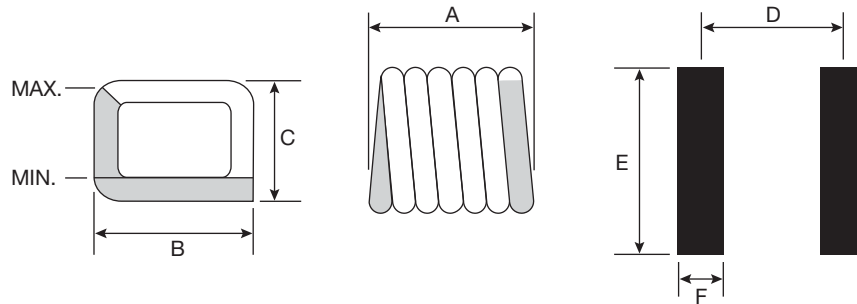

mm (inches)

| Part Number | A | B | C | D | E | F |
|-------------|------------------------------|------------------------------|------------------------------|------------------|-----------------|-----------------|
| AS0605N5*TR | 1.346±0.102 (0.053±0.004) | 1.829±0.254 (0.072±0.01) | 1.397±0.102 (0.055±0.004) | 0.962 (0.038) | 2.60 (0.102) | 0.51 (0.020) |
| AS0606N0*TR | 1.295±0.102 (0.051±0.004) | 1.829±0.254 (0.072±0.01) | 1.397±0.102 (0.055±0.004) | 0.99 (0.390) | 2.60 (0.102) | 0.51 (0.020) |
| AS0608N9*TR | 1.626±0.152 (0.640±0.006) | 1.829±0.254 (0.072±0.01) | 1.397±0.102 (0.055±0.004) | 1.27 (0.050) | 2.60 (0.102) | 0.51 (0.020) |
| AS0612N3*TR | 1.930±0.152 (0.076±0.006) | 1.829±0.254 (0.072±0.01) | 1.397±0.102 (0.055±0.004) | 1.63 (0.064) | 2.60 (0.102) | 0.51 (0.020) |
| AS0615N7*TR | 2.286±0.152 (0.09±0.006) | 1.829±0.254 (0.072±0.01) | 1.397±0.102 (0.055±0.004) | 1.96 (0.070) | 2.60 (0.102) | 0.51 (0.020) |
| AS0619N4*TR | 2.591±0.152 (0.102±0.006) | 1.829±0.254 (0.072±0.01) | 1.397±0.102 (0.055±0.004) | 2.29 (0.090) | 2.60 (0.102) | 0.51 (0.020) |
| AS0706N9*TR | 1.295±0.102 (0.051±0.004) | 1.829±0.254 (0.072±0.01) | 1.524±0.254 (0.060±0.010) | 1.02 (0.040) | 2.60 (0.102) | 0.51 (0.020) |
| AS0710N2*TR | 1.626±0.152 (0.064±0.006) | 1.829±0.254 (0.072±0.01) | 1.524±0.254 (0.060±0.010) | 1.32 (0.052) | 2.60 (0.102) | 0.51 (0.020) |
| AS0711N2*TR | 1.549±0.152 (0.061±0.006) | 1.829±0.254 (0.072±0.01) | 1.524±0.254 (0.060±0.010) | 1.24 (0.049) | 2.60 (0.102) | 0.51 (0.020) |
| AS0713N7*TR | 1.930±0.152 (0.076±0.006) | 1.829±0.254 (0.072±0.01) | 1.524±0.254 (0.060±0.010) | 1.57 (0.062) | 2.60 (0.102) | 0.51 (0.020) |
| AS0717N0*TR | 2.286±0.152 (0.09±0.006) | 1.829±0.254 (0.072±0.01) | 1.524±0.254 (0.060±0.010) | 1.93 (0.076) | 2.60 (0.102) | 0.51 (0.020) |
| AS0722N0*TR | 2.591±0.152 (0.102±0.006) | 1.829±0.254 (0.072±0.01) | 1.524±0.254 (0.060±0.010) | 2.29 (0.090) | 2.60 (0.102) | 0.51 (0.020) |
| AS0808N1*TR | 1.473±0.152 (0.058±0.006) | 2.134±0.152 (0.084±0.006) | 1.829±0.152 (0.072±0.006) | 1.12 (0.044) | 2.80 (0.110) | 0.64 (0.025) |
| AS0812N0*TR | 1.854±0.152 (0.073±0.006) | 2.134±0.152 (0.084±0.006) | 1.829±0.152 (0.072±0.006) | 1.45 (0.570) | 2.80 (0.110) | 0.64 (0.025) |
| AS0814N7*TR | 1.549±0.152 (0.061±0.006) | 2.134±0.152 (0.084±0.006) | 1.829±0.152 (0.072±0.006) | 1.24 (0.049) | 2.80 (0.110) | 0.64 (0.025) |
| AS0816N6*TR | 2.210±0.152 (0.087±0.006) | 2.134±0.152 (0.084±0.006) | 1.829±0.152 (0.072±0.006) | 1.83 (0.072) | 2.80 (0.110) | 0.64 (0.025) |
| AS0821N5*TR | 2.565±0.152 (0.101±0.006) | 2.134±0.152 (0.084±0.006) | 1.829±0.152 (0.072±0.006) | 2.18 (0.086) | 2.80 (0.110) | 0.64 (0.025) |
| AS0823N0*TR | 2.235±0.152 (0.088±0.006) | 2.134±0.152 (0.084±0.006) | 1.829±0.152 (0.072±0.006) | 1.90 (0.075) | 2.80 (0.110) | 0.64 (0.025) |
| AS0825N0*TR | 2.972±0.152 (0.117±0.006) | 2.134±0.152 (0.084±0.006) | 1.829±0.152 (0.072±0.006) | 2.57 (0.101) | 2.80 (0.110) | 0.64 (0.025) |
| AS0827N3*TR | 2.972±0.152 (0.117±0.006) | 2.134±0.152 (0.084±0.006) | 1.829±0.152 (0.072±0.006) | 2.57 (0.101) | 2.80 (0.110) | 0.64 (0.025) |

7

PERFORMANCE SPECIFICATIONS

AS06

Inductance vs. Frequency

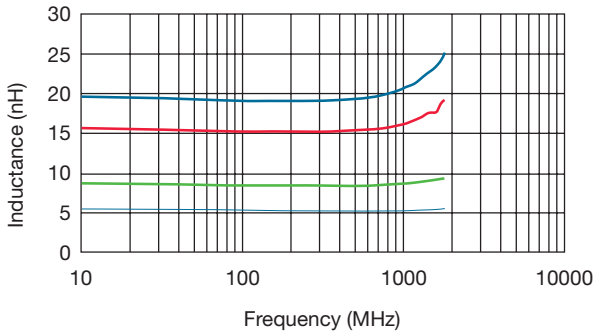

Typical Q vs. Frequency

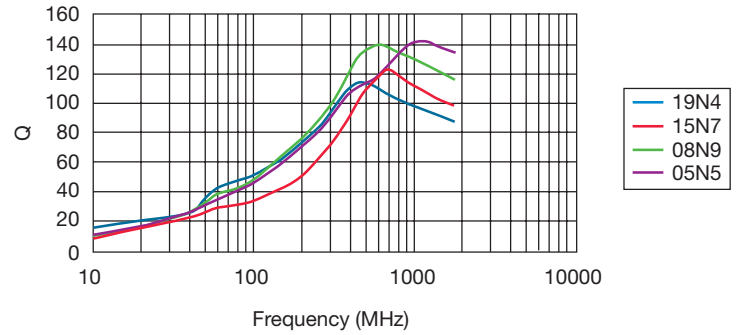

AS07

Inductance vs. Frequency

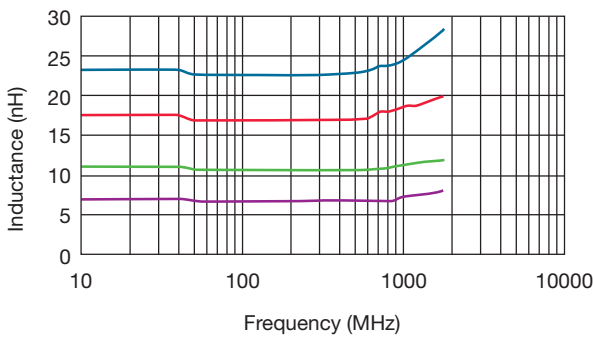

Typical Q vs. Frequency

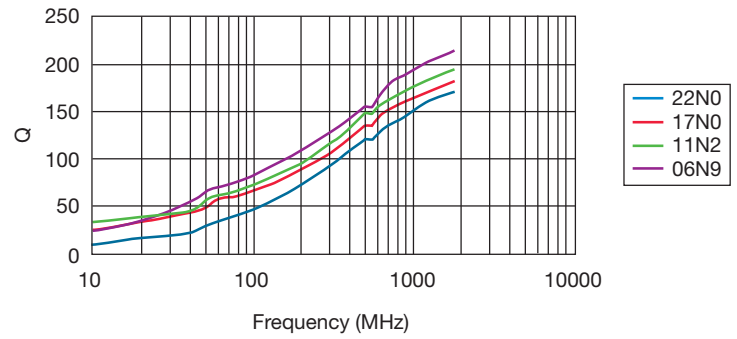

AS08

Inductance vs. Frequency

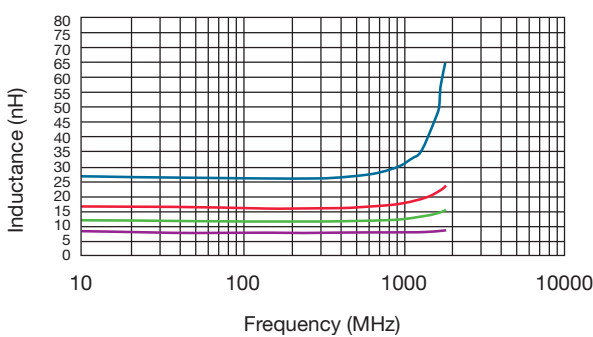

Typical Q vs. Frequency

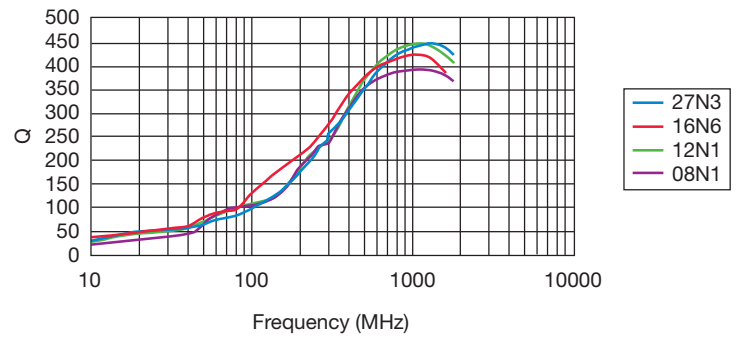

Square Air Core RF Inductors



AS Series

TYPICAL RoHS REFLOW PROFILE

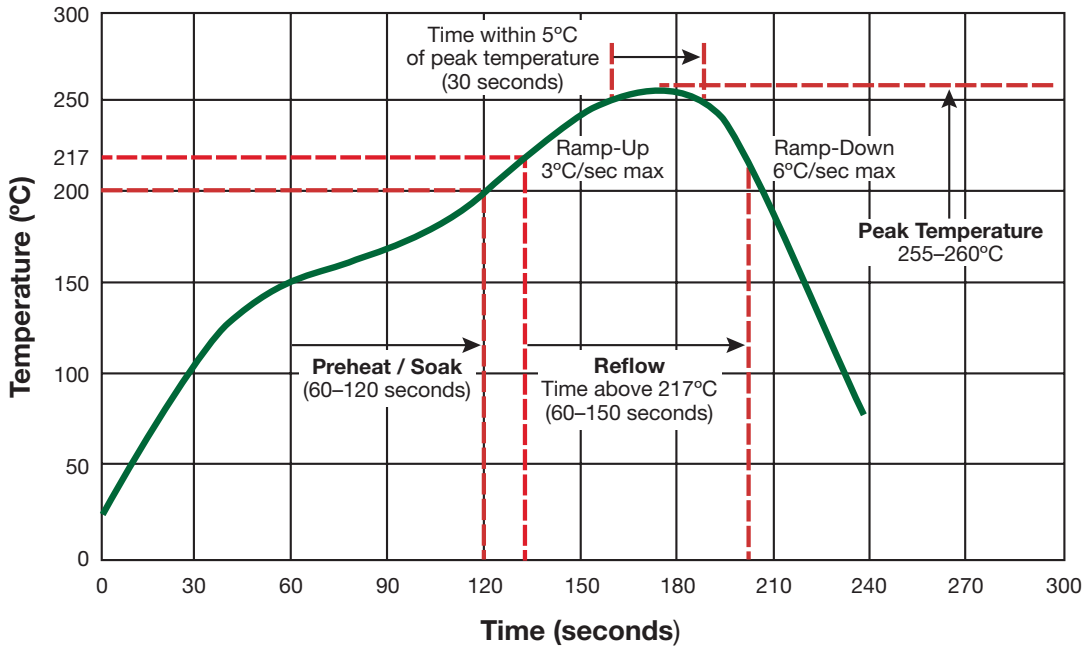

7



PACKAGING SPECIFICATIONS

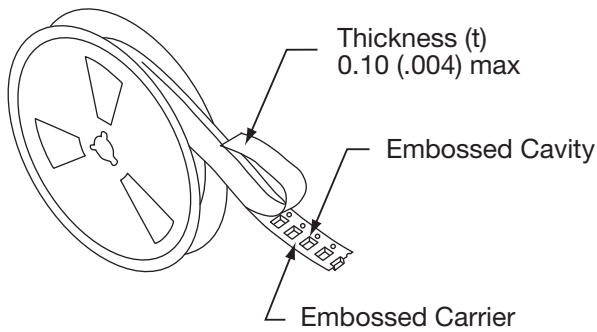

- The force for tearing off cover tape is 10 to 130 grams in the arrow direction

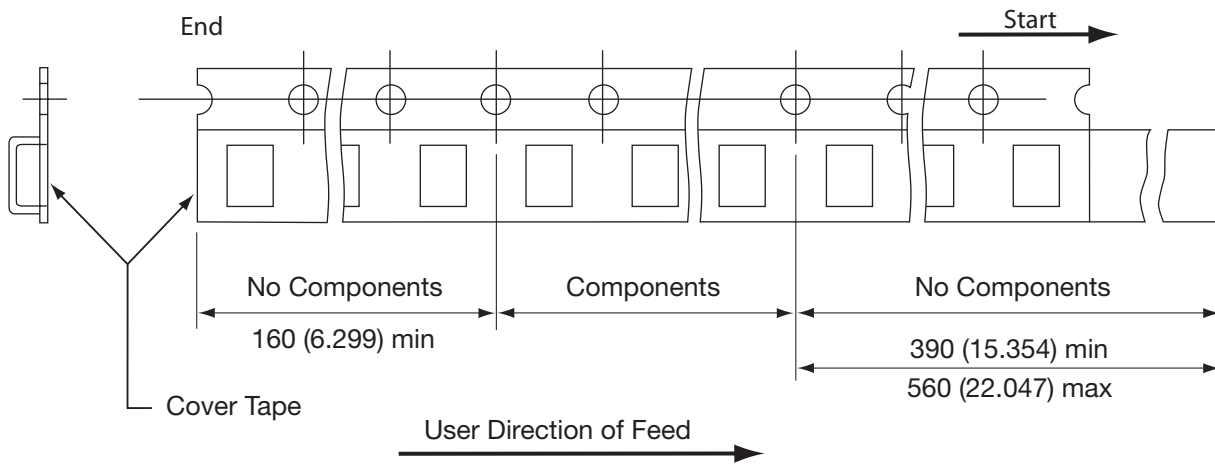
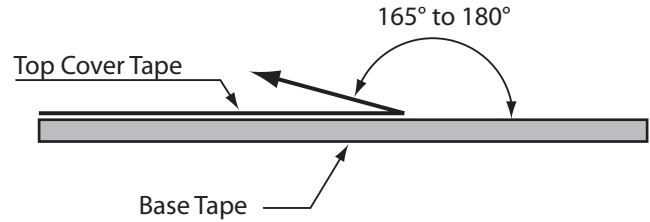

CARRIER TAPE REELS

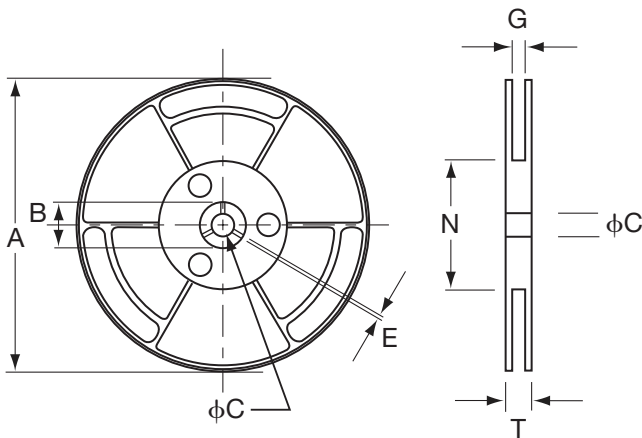

DIMENSIONS OF CARRIER TAPE

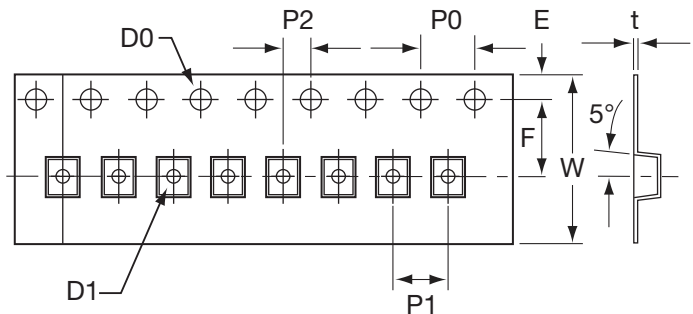

mm (inches)

| ITEM | A | B | C | G | N | T | W | E | F | P1 | P2 | P0 | D0 | D1 | t |
|-------------|-----------------|-----------------|-----------------|-----------------|-----------------|-----------------|-----------------|-----------------|-----------------|-----------------|-----------------|-----------------|-----------------|-----------------|------------------|
| DIM. | 178 (7.008) | 25 (0.984) | 15 (0.591) | 12.5 (0.492) | 75 (2.953) | 16.4 (0.646) | 12.0 (0.472) | 1.75 (0.069) | 5.50 (0.217) | 4.00 (0.157) | 2.0 (0.079) | 4.0 (0.157) | 1.5 (0.059) | 1.0 (0.039) | 0.23 (0.009) |
| TOL. | ±2.0 (0.079) | ±1.0 (0.039) | ±0.5 (0.020) | ±1.5 (0.059) | ±2.0 (0.079) | ±1.5 (0.059) | ±0.2 (0.008) | ±0.1 (0.004) | ±0.1 (0.004) | ±0.1 (0.004) | ±0.1 (0.004) | ±0.1 (0.004) | ±0.1 (0.004) | ±0.1 (0.004) | ±0.05 (0.020) |

Wire Wound Chip Inductor



LCWC Series

FEATURES

- Ceramic base provide high SRF
- Ultra-compact inductors provide high Q factors
- Low profile, high current are available
- Miniature SMD chip inductor for fully automated assembly
- Outstanding endurance from Pull-up force, mechanical shock and pressure
- Tighter tolerance down to $\pm 2\%$
- Smaller size of 0402 (1005)

APPLICATIONS

RF Products:

- Cellular Phone (CDMA/GSM/PHS)
- Cordless Phone (DECT/CT1CT2)
- Remote Control, Security System
- Wireless PDA
- Smart Phone
- WLL, Wireless LAN / Mouse / Keyboard / Earphone
- VCO, RF Module & Other Wireless Products

- Base Station, Repeater

- GPS Receiver

Broad Band Applications:

- CATV Filter, Tuner
- Cable Modem/ XDSL Tuner
- Set Top Box

IT Applications:

- USB 2.0
- IEEE 1394

DIMENSIONS

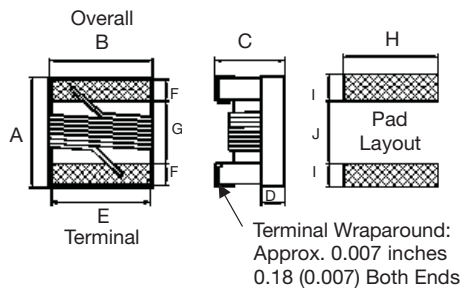

CONSTRUCTION

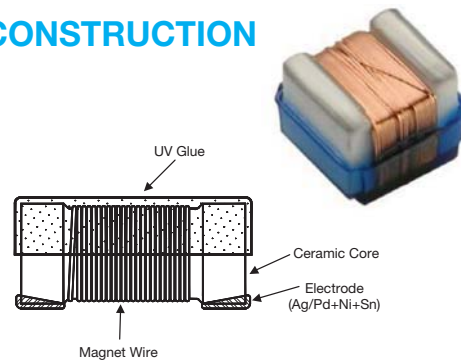

COLOR CODING

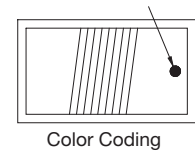

STANDARD

| Type | Size (inch) | A Max. | B Max. | C Max. | D Ref. | E | F | G | H | I | J | Weight (g) (1000pcs) |
|------|-------------|--------------|--------------|--------------|--------------|--------------|--------------|--------------|--------------|--------------|--------------|----------------------|
| 0402 | 0402 | 1.27 (0.050) | 0.76 (0.030) | 0.61 (0.024) | 0.15 (0.006) | 0.51 (0.020) | 0.23 (0.009) | 0.56 (0.022) | 0.66 (0.026) | 0.50 (0.020) | 0.46 (0.018) | 0.8 |
| 0603 | 0603 | 1.80 (0.071) | 1.12 (0.044) | 1.02 (0.040) | 0.38 (0.015) | 0.76 (0.030) | 0.33 (0.013) | 0.86 (0.034) | 1.02 (0.040) | 0.64 (0.025) | 0.64 (0.025) | 3.46 |
| 0805 | 0805 | 2.29 (0.090) | 1.73 (0.068) | 1.52 (0.060) | 0.51 (0.020) | 1.27 (0.050) | 0.44 (0.017) | 1.02 (0.040) | 1.78 (0.070) | 1.02 (0.040) | 0.76 (0.030) | 12.13 |
| 1008 | 1008 | 2.92 (0.115) | 2.79 (0.110) | 2.13 (0.084) | 0.65 (0.026) | 2.03 (0.080) | 0.51 (0.020) | 1.52 (0.060) | 2.54 (0.100) | 1.02 (0.040) | 1.27 (0.050) | 30.73 |
| 1206 | 1206 | 3.45 (0.136) | 1.90 (0.075) | 1.40 (0.055) | 0.50 (0.020) | 1.60 (0.063) | 0.50 (0.020) | 2.20 (0.087) | 1.93 (0.076) | 1.02 (0.040) | 1.78 (0.070) | 40 |

LOW PROFILE

| Type | Size (inch) | A Max. | B Max. | C Max. | D Ref. | E | F | G | H | I | J |
|------|-------------|--------------|--------------|--------------|--------------|--------------|--------------|--------------|--------------|--------------|--------------|
| 0805 | 0805 | 2.29 (0.090) | 1.73 (0.068) | 1.03 (0.041) | 0.51 (0.020) | 1.27 (0.050) | 0.44 (0.017) | 1.02 (0.040) | 1.78 (0.070) | 1.02 (0.040) | 0.76 (0.030) |
| 1008 | 1008 | 2.92 (0.115) | 2.79 (0.110) | 1.40 (0.055) | 0.65 (0.026) | 2.03 (0.080) | 0.51 (0.020) | 1.52 (0.060) | 2.54 (0.100) | 1.02 (0.040) | 1.27 (0.050) |

HIGH CURRENT/HIGH Q

| Type | Size (inch) | A Max. | B Max. | C Max. | D Ref. | E | F | G | H | I | J |
|------|-------------|--------------|--------------|--------------|--------------|--------------|--------------|--------------|--------------|--------------|--------------|
| 0603 | 0603 | 1.80 (0.071) | 1.12 (0.044) | 1.02 (0.040) | 0.38 (0.015) | 0.76 (0.030) | 0.33 (0.013) | 0.86 (0.034) | 1.02 (0.040) | 0.64 (0.025) | 0.64 (0.025) |
| 0805 | 0805 | 2.29 (0.090) | 1.73 (0.068) | 1.52 (0.060) | 0.51 (0.020) | 1.27 (0.050) | 0.44 (0.017) | 1.02 (0.040) | 1.78 (0.070) | 1.02 (0.040) | 0.76 (0.030) |
| 1008 | 1008 | 2.92 (0.115) | 2.79 (0.110) | 2.03 (0.080) | 0.65 (0.026) | 2.03 (0.080) | 0.51 (0.020) | 1.52 (0.060) | 2.54 (0.100) | 1.02 (0.040) | 1.27 (0.050) |

Wire Wound Chip Inductor



LCWC Series

HOW TO ORDER

| | | | | | | | | |
|--------------------|-----------------|--------------------------------------|-----------------------------|---|---|--------------|--------------|-------------|
| LC | WC | 0402 | K | 101 | G | T | A | R |
| Family | Series | Size | Tolerance | Inductance | Style | Termination | Special | Packaging |
| LC = Chip Inductor | WC = WW Ceramic | 0402 0603 0805 1008 1206 | G = 2% J = 5% K = 10% | 3N9 = 3.9nH 39N = 39nH R39 = 390nH 3R9 = 3900nH 153 = 15000nH | G = Standard Q = High Q/ Current R = Low Profile | T = Sn Plate | A = Standard | R = 7" Reel |



STANDARD ELECTRICAL SPECIFICATIONS

| 0402 | | | | | | | | | | |
|-----------------|--------------|---------------|---------------------|------------|--------------|---------------|--------|----|--------|-----|
| Inductance (nH) | Tolerance | L Freq. (MHz) | Quality Factor Min. | SRF Factor | DCR (Ω) max. | IDC (mA) max. | 900MHz | | 1.7GHz | |
| | | | | | | | L | Q | L | Q |
| 1.0 | ±10% | 250 | 16 | 12.70 | 0.045 | 1360 | 1.02 | 77 | 1.02 | 69 |
| 1.9 | ±10% | 250 | 16 | 11.30 | 0.070 | 1040 | 1.72 | 68 | 1.74 | 82 |
| 2.0 | ±10% | 250 | 16 | 11.10 | 0.070 | 1040 | 1.93 | 54 | 1.93 | 75 |
| 2.2 | ±10% | 250 | 19 | 10.80 | 0.070 | 960 | 2.19 | 59 | 2.23 | 100 |
| 2.4 | ±10% | 250 | 15 | 10.50 | 0.070 | 790 | 2.24 | 51 | 2.27 | 68 |
| 2.7 | ±10% | 250 | 16 | 10.40 | 0.120 | 640 | 2.23 | 42 | 2.25 | 61 |
| 3.3 | ±10% | 250 | 19 | 7.00 | 0.066 | 840 | 3.10 | 65 | 3.12 | 87 |
| 3.6 | ±5, ±10% | 250 | 19 | 6.80 | 0.066 | 840 | 3.56 | 45 | 3.62 | 71 |
| 3.9 | ±5, ±10% | 250 | 19 | 5.80 | 0.066 | 840 | 3.89 | 50 | 4.00 | 75 |
| 4.3 | ±5, ±10% | 250 | 18 | 6.00 | 0.091 | 700 | 4.19 | 47 | 4.30 | 71 |
| 4.7 | ±5, ±10% | 250 | 18 | 4.70 | 0.130 | 640 | 4.55 | 48 | 4.68 | 68 |
| 5.1 | ±5, ±10% | 250 | 20 | 4.80 | 0.083 | 800 | 5.15 | 56 | 5.25 | 82 |
| 5.6 | ±5, ±10% | 250 | 20 | 4.80 | 0.083 | 760 | 5.16 | 54 | 5.28 | 81 |
| 6.2 | ±5, ±10% | 250 | 20 | 4.80 | 0.083 | 760 | 6.16 | 52 | 6.37 | 76 |
| 6.8 | ±5, ±10% | 250 | 20 | 4.80 | 0.083 | 680 | 6.56 | 63 | 6.93 | 78 |
| 7.5 | ±5, ±10% | 250 | 22 | 4.80 | 0.104 | 680 | 7.91 | 60 | 8.22 | 88 |
| 8.2 | ±5, ±10% | 250 | 22 | 4.40 | 0.104 | 680 | 8.50 | 57 | 8.85 | 84 |
| 8.7 | ±5, ±10% | 250 | 18 | 4.10 | 0.200 | 480 | 8.78 | 54 | 9.21 | 73 |
| 9.0 | ±5, ±10% | 250 | 22 | 4.16 | 0.104 | 680 | 9.07 | 62 | 9.53 | 78 |
| 9.5 | ±5, ±10% | 250 | 18 | 4.00 | 0.200 | 480 | 9.42 | 54 | 9.98 | 69 |
| 10 | ±2, ±5, ±10% | 250 | 21 | 3.90 | 0.195 | 480 | 9.80 | 50 | 10.10 | 67 |
| 11 | ±2, ±5, ±10% | 250 | 24 | 3.68 | 0.120 | 640 | 10.70 | 52 | 11.20 | 78 |
| 12 | ±2, ±5, ±10% | 250 | 24 | 3.60 | 0.120 | 640 | 11.90 | 53 | 12.70 | 71 |
| 13 | ±2, ±5, ±10% | 250 | 24 | 3.45 | 0.210 | 440 | 13.40 | 51 | 14.60 | 57 |
| 15 | ±2, ±5, ±10% | 250 | 24 | 3.28 | 0.172 | 560 | 14.60 | 55 | 15.50 | 77 |
| 16 | ±2, ±5, ±10% | 250 | 24 | 3.10 | 0.220 | 560 | 16.60 | 46 | 18.80 | 47 |
| 18 | ±2, ±5, ±10% | 250 | 25 | 3.10 | 0.230 | 420 | 18.30 | 57 | 20.30 | 62 |
| 19 | ±2, ±5, ±10% | 250 | 24 | 3.04 | 0.202 | 480 | 19.10 | 50 | 21.10 | 67 |
| 20 | ±2, ±5, ±10% | 250 | 25 | 3.00 | 0.250 | 420 | 20.70 | 52 | 23.70 | 53 |
| 22 | ±2, ±5, ±10% | 250 | 25 | 2.80 | 0.300 | 400 | 23.20 | 53 | 26.80 | 53 |
| 23 | ±2, ±5, ±10% | 250 | 24 | 2.72 | 0.300 | 400 | 23.80 | 49 | 26.90 | 64 |
| 24 | ±2, ±5, ±10% | 250 | 25 | 2.70 | 0.300 | 400 | 25.10 | 51 | 29.50 | 50 |
| 27 | ±2, ±5, ±10% | 250 | 24 | 2.48 | 0.300 | 400 | 28.70 | 49 | 33.50 | 63 |
| 30 | ±2, ±5, ±10% | 250 | 25 | 2.35 | 0.350 | 400 | 31.10 | 46 | 38.50 | 39 |
| 33 | ±2, ±5, ±10% | 250 | 24 | 2.35 | 0.350 | 400 | 34.90 | 31 | 41.70 | 32 |
| 36 | ±2, ±5, ±10% | 250 | 24 | 2.32 | 0.440 | 320 | 39.50 | 44 | 48.40 | 53 |
| 39 | ±2, ±5, ±10% | 250 | 25 | 2.10 | 0.550 | 200 | 41.70 | 47 | 50.20 | 45 |
| 40 | ±2, ±5, ±10% | 250 | 24 | 2.24 | 0.500 | 320 | 39.00 | 44 | 47.40 | 33 |
| 43 | ±2, ±5, ±10% | 250 | 25 | 2.03 | 0.810 | 100 | 45.80 | 46 | 61.60 | 34 |
| 47 | ±2, ±5, ±10% | 250 | 25 | 2.10 | 0.830 | 150 | 50.00 | 38 | 55.80 | 37 |
| 51 | ±2, ±5, ±10% | 250 | 25 | 1.75 | 0.820 | 100 | 50.40 | 47 | 59.40 | 37 |
| 56 | ±2, ±5, ±10% | 250 | 25 | 1.76 | 0.970 | 100 | 57.40 | 49 | 72.40 | 40 |
| 68 | ±2, ±5, ±10% | 250 | 22 | 1.62 | 1.120 | 100 | 69.60 | 45 | 83.40 | 38 |



Wire Wound Chip Inductor



LCWC Series

0603

| Inductance (nH) | Tolerance | L Freq. (MHz) | Quality Factor Min. | SRF Factor | DCR (Ω) max. | IDC (mA) max. | 900MHz | | 1.7GHz | | Color Code |
|-----------------|--------------|---------------|---------------------|------------|--------------|---------------|--------|----|--------|----|------------|
| | | | | | | | L | Q | L | Q | |
| 1.6 | ±5, ±10% | 250 | 24 | 12.5 | 0.030 | 700 | 1.53 | 35 | 1.58 | 55 | Blue |
| 1.8 | ±5, ±10% | 250 | 16 | 12.5 | 0.045 | 700 | 1.63 | 35 | 1.66 | 50 | Black |
| 2.2 | ±5, ±10% | 250 | 15 | 6.00 | 0.100 | 700 | 2.18 | 41 | 2.20 | 64 | White |
| 2.3 | ±5, ±10% | 250 | 16 | >4.00 | 0.140 | 700 | 2.32 | 32 | 2.35 | 40 | Yellow |
| 3.3 | ±2, ±5, ±10% | 250 | 22 | >6.00 | 0.080 | 700 | 3.35 | 47 | 3.40 | 65 | Red |
| 3.6 | ±2, ±5, ±10% | 250 | 22 | 5.80 | 0.063 | 700 | 3.53 | 49 | 3.58 | 65 | Violet |
| 3.9 | ±2, ±5, ±10% | 250 | 22 | >6.00 | 0.080 | 700 | 3.95 | 49 | 3.96 | 67 | Brown |
| 4.3 | ±2, ±5, ±10% | 250 | 22 | 5.80 | 0.063 | 700 | 4.32 | 49 | 4.43 | 67 | Orange |
| 4.5 | ±2, ±5, ±10% | 250 | 20 | 5.80 | 0.120 | 700 | 4.74 | 55 | 4.87 | 92 | Gray |
| 4.7 | ±2, ±5, ±10% | 250 | 25 | 5.80 | 0.120 | 700 | 4.65 | 53 | 4.80 | 67 | Violet |
| 5.1 | ±2, ±5, ±10% | 250 | 20 | 5.80 | 0.160 | 700 | 5.13 | 47 | 5.36 | 56 | Green |
| 5.6 | ±2, ±5, ±10% | 250 | 20 | 5.80 | 0.170 | 700 | 5.53 | 56 | 5.86 | 77 | Yellow |
| 6.2 | ±2, ±5, ±10% | 250 | 25 | 5.80 | 0.110 | 700 | 6.28 | 60 | 6.40 | 85 | Black |
| 6.3 | ±2, ±5, ±10% | 250 | 25 | 5.80 | 0.110 | 700 | 6.67 | 41 | 6.86 | 61 | Black |
| 6.8 | ±2, ±5, ±10% | 250 | 27 | 5.80 | 0.110 | 700 | 6.75 | 60 | 7.10 | 81 | Red |
| 7.5 | ±2, ±5, ±10% | 250 | 28 | 4.80 | 0.106 | 700 | 7.70 | 60 | 7.82 | 65 | Brown |
| 8.2 | ±2, ±5, ±10% | 250 | 27 | 4.80 | 0.110 | 700 | 8.25 | 64 | 8.40 | 81 | Green |
| 8.7 | ±2, ±5, ±10% | 250 | 28 | 4.80 | 0.109 | 700 | 8.86 | 62 | 9.32 | 58 | Yellow |
| 9.1 | ±2, ±5, ±10% | 250 | 35 | 4.80 | 0.130 | 700 | 9.20 | 70 | 9.70 | 80 | Black |
| 9.5 | ±2, ±5, ±10% | 250 | 28 | 5.40 | 0.135 | 700 | 9.70 | 59 | 9.92 | 61 | Blue |
| 10 | ±2, ±5, ±10% | 250 | 31 | 4.80 | 0.130 | 700 | 10.0 | 66 | 10.6 | 83 | Orange |
| 11 | ±2, ±5, ±10% | 250 | 31 | 4.00 | 0.086 | 700 | 11.3 | 53 | 12.1 | 56 | Gray |
| 12 | ±2, ±5, ±10% | 250 | 35 | 4.00 | 0.130 | 700 | 12.3 | 72 | 13.5 | 83 | Yellow |
| 15 | ±2, ±5, ±10% | 250 | 35 | 4.00 | 0.170 | 700 | 15.4 | 64 | 16.8 | 89 | Green |
| 16 | ±2, ±5, ±10% | 250 | 35 | 3.30 | 0.110 | 700 | 16.5 | 55 | 18.0 | 52 | White |
| 17 | ±2, ±5, ±10% | 250 | 35 | 3.20 | 0.170 | 700 | 17.6 | 56 | 19.4 | 44 | Red |
| 18 | ±2, ±5, ±10% | 250 | 35 | 3.10 | 0.170 | 700 | 18.7 | 70 | 21.4 | 69 | Blue |
| 20 | ±2, ±5, ±10% | 250 | 40 | 3.00 | 0.190 | 700 | 20.7 | 80 | 23.5 | 30 | Green |
| 22 | ±2, ±5, ±10% | 250 | 38 | 3.00 | 0.190 | 700 | 22.8 | 73 | 26.1 | 71 | Violet |
| 23 | ±2, ±5, ±10% | 250 | 38 | 2.85 | 0.190 | 700 | 24.1 | 71 | 28.0 | 71 | Orange |
| 24 | ±2, ±5, ±10% | 250 | 38 | 2.80 | 0.130 | 700 | 25.7 | 45 | 30.9 | 40 | Black |
| 27 | ±2, ±5, ±10% | 250 | 40 | 2.80 | 0.220 | 600 | 29.2 | 74 | 34.6 | 65 | Gray |
| 30 | ±2, ±5, ±10% | 250 | 40 | 2.80 | 0.150 | 600 | 31.4 | 47 | 39.8 | 28 | Brown |
| 33 | ±2, ±5, ±10% | 250 | 40 | 2.30 | 0.220 | 600 | 36.0 | 67 | 49.5 | 42 | White |
| 36 | ±2, ±5, ±10% | 250 | 37 | 2.30 | 0.250 | 600 | 39.1 | 47 | 48.9 | 24 | Red |
| 39 | ±2, ±5, ±10% | 250 | 40 | 2.20 | 0.250 | 600 | 42.7 | 60 | 60.2 | 40 | Black |
| 43 | ±2, ±5, ±10% | 200 | 38 | 2.00 | 0.280 | 600 | 46.9 | 44 | 60.3 | 21 | Orange |
| 47 | ±2, ±5, ±10% | 200 | 38 | 2.00 | 0.280 | 600 | 52.2 | 62 | 77.2 | 35 | Brown |
| 51 | ±2, ±5, ±10% | 200 | 38 | 1.90 | 0.280 | 600 | 55.5 | 69 | 82.2 | 34 | Blue |
| 56 | ±2, ±5, ±10% | 200 | 38 | 1.90 | 0.310 | 600 | 62.5 | 56 | 97.0 | 26 | Red |
| 62 | ±2, ±5, ±10% | 200 | 37 | 1.80 | 0.340 | 600 | 68.0 | 40 | 110 | 10 | Gray |
| 68 | ±2, ±5, ±10% | 200 | 37 | 1.70 | 0.340 | 600 | 80.5 | 54 | 168 | 21 | Orange |
| 72 | ±2, ±5, ±10% | 150 | 34 | 1.70 | 0.490 | 600 | 82.0 | 53 | 135 | 20 | Yellow |
| 82 | ±2, ±5, ±10% | 150 | 34 | 1.70 | 0.540 | 400 | 96.2 | 54 | 177 | 21 | Green |
| 91 | ±2, ±5, ±10% | 150 | 30 | 1.70 | 0.500 | 400 | 110.0 | 50 | 416.4 | 6 | Brown |
| 100 | ±2, ±5, ±10% | 150 | 34 | 1.40 | 0.580 | 400 | 124.0 | 49 | 319.5 | 13 | Blue |
| 110 | ±2, ±5, ±10% | 150 | 32 | 1.35 | 0.610 | 300 | 138.0 | 43 | 342.7 | 15 | Violet |
| 120 | ±2, ±5, ±10% | 150 | 32 | 1.30 | 0.650 | 300 | 166.0 | 39 | 529.3 | 8 | Gray |
| 130 | ±2, ±5, ±10% | 150 | 30 | 1.40 | 0.720 | 300 | 185.0 | 60 | - | - | White |
| 140 | ±2, ±5, ±10% | 100 | 28 | 1.30 | 0.870 | 280 | 190.0 | 80 | - | - | Blue |
| 150 | ±2, ±5, ±10% | 100 | 28 | 1.30 | 0.950 | 280 | 230.0 | 25 | - | - | White |
| 160 | ±2, ±5, ±10% | 100 | 25 | 1.30 | 1.400 | 280 | 215.0 | 20 | - | - | Yellow |
| 180 | ±2, ±5, ±10% | 100 | 25 | 1.25 | 1.400 | 250 | 305.0 | 22 | - | - | Black |
| 220 | ±2, ±5, ±10% | 100 | 25 | 1.20 | 1.600 | 250 | 377.0 | 21 | - | - | Brown |
| 260 | ±2, ±5, ±10% | 100 | 25 | 1.00 | 2.000 | 200 | 469.0 | 21 | - | - | Violet |
| 270 | ±2, ±5, ±10% | 100 | 25 | 0.90 | 2.100 | 200 | 523.0 | 19 | - | - | Red |
| 280 | ±2, ±5, ±10% | 100 | 25 | 1.00 | 2.400 | 100 | 524.0 | 18 | - | - | Green |
| 300 | ±2, ±5, ±10% | 100 | 25 | 0.75 | 2.500 | 150 | 539.7 | 21 | - | - | Orange |
| 330 | ±2, ±5, ±10% | 100 | 25 | 0.90 | 3.800 | 100 | 680.4 | 20 | - | - | Blue |
| 390 | ±2, ±5, ±10% | 100 | 25 | 0.90 | 4.350 | 100 | 734.5 | 29 | - | - | Yellow |
| 470 | ±2, ±5, ±10% | 100 | 23 | 0.60 | 3.600 | 80 | - | - | - | - | White |

7



Wire Wound Chip Inductor

LCWC Series



0805

| Inductance (nH) | Tolerance | L Freq. (MHz) | Quality Factor min. | SRF (GHz) min. | DCR (Ω) max. | IDC (mA) max. | Color Code |
|-----------------|--------------------------|---------------|---------------------|----------------|-----------------------|---------------|------------|
| 2.7 | $\pm 5, \pm 10\%$ | 250 | 80 @ 1500MHz | 7.900 | 0.06 | 800 | Brown |
| 2.8 | $\pm 5, \pm 10\%$ | 250 | 80 @ 1500MHz | 7.900 | 0.06 | 800 | Gray |
| 3.0 | $\pm 5, \pm 10\%$ | 250 | 65 @ 1500MHz | 7.900 | 0.06 | 800 | White |
| 3.3 | $\pm 5, \pm 10\%$ | 250 | 50 @ 1500MHz | 6.000 | 0.08 | 600 | Black |
| 5.6 | $\pm 5, \pm 10\%$ | 250 | 65 @ 1000MHz | 5.500 | 0.08 | 600 | Orange |
| 6.2 | $\pm 5, \pm 10\%$ | 250 | 50 @ 1000MHz | 5.500 | 0.11 | 600 | Green |
| 6.8 | $\pm 5, \pm 10\%$ | 250 | 50 @ 1000MHz | 5.500 | 0.11 | 600 | Brown |
| 7.5 | $\pm 5, \pm 10\%$ | 250 | 50 @ 1000MHz | 4.500 | 0.14 | 600 | Green |
| 8.2 | $\pm 5, \pm 10\%$ | 250 | 50 @ 1000MHz | 4.700 | 0.12 | 600 | Red |
| 8.7 | $\pm 5, \pm 10\%$ | 250 | 50 @ 1000MHz | 4.000 | 0.21 | 400 | White |
| 10 | $\pm 2, \pm 5, \pm 10\%$ | 250 | 60 @ 500MHz | 4.200 | 0.10 | 600 | Blue |
| 12 | $\pm 2, \pm 5, \pm 10\%$ | 250 | 50 @ 500MHz | 4.000 | 0.15 | 600 | Orange |
| 15 | $\pm 2, \pm 5, \pm 10\%$ | 250 | 50 @ 500MHz | 3.400 | 0.17 | 600 | Yellow |
| 18 | $\pm 2, \pm 5, \pm 10\%$ | 250 | 50 @ 500MHz | 3.300 | 0.20 | 600 | Green |
| 22 | $\pm 2, \pm 5, \pm 10\%$ | 250 | 55 @ 500MHz | 2.600 | 0.22 | 500 | Blue |
| 24 | $\pm 2, \pm 5, \pm 10\%$ | 250 | 50 @ 500MHz | 2.000 | 0.22 | 500 | Gray |
| 27 | $\pm 2, \pm 5, \pm 10\%$ | 250 | 55 @ 500MHz | 2.500 | 0.25 | 500 | Violet |
| 33 | $\pm 2, \pm 5, \pm 10\%$ | 250 | 60 @ 500MHz | 2.050 | 0.27 | 500 | Gray |
| 36 | $\pm 2, \pm 5, \pm 10\%$ | 250 | 55 @ 500MHz | 1.700 | 0.27 | 500 | Orange |
| 39 | $\pm 2, \pm 5, \pm 10\%$ | 250 | 60 @ 500MHz | 2.000 | 0.29 | 500 | White |
| 43 | $\pm 2, \pm 5, \pm 10\%$ | 200 | 60 @ 500MHz | 1.650 | 0.34 | 500 | Yellow |
| 47 | $\pm 2, \pm 5, \pm 10\%$ | 200 | 60 @ 500MHz | 1.650 | 0.31 | 500 | Black |
| 56 | $\pm 2, \pm 5, \pm 10\%$ | 200 | 60 @ 500MHz | 1.550 | 0.34 | 500 | Brown |
| 68 | $\pm 2, \pm 5, \pm 10\%$ | 200 | 60 @ 500MHz | 1.450 | 0.38 | 500 | Red |
| 72 | $\pm 2, \pm 5, \pm 10\%$ | 150 | 65 @ 500MHz | 1.400 | 0.40 | 500 | Green |
| 82 | $\pm 2, \pm 5, \pm 10\%$ | 150 | 65 @ 500MHz | 1.300 | 0.42 | 400 | Orange |
| 91 | $\pm 2, \pm 5, \pm 10\%$ | 150 | 65 @ 500MHz | 1.200 | 0.48 | 400 | Black |
| 100 | $\pm 2, \pm 5, \pm 10\%$ | 150 | 65 @ 500MHz | 1.200 | 0.46 | 400 | Yellow |
| 110 | $\pm 2, \pm 5, \pm 10\%$ | 150 | 50 @ 250MHz | 1.000 | 0.48 | 400 | Brown |
| 120 | $\pm 2, \pm 5, \pm 10\%$ | 150 | 50 @ 250MHz | 1.100 | 0.51 | 400 | Green |
| 150 | $\pm 2, \pm 5, \pm 10\%$ | 100 | 50 @ 250MHz | 0.920 | 0.56 | 400 | Blue |
| 180 | $\pm 2, \pm 5, \pm 10\%$ | 100 | 50 @ 250MHz | 0.870 | 0.64 | 400 | Violet |
| 200 | $\pm 2, \pm 5, \pm 10\%$ | 100 | 50 @ 250MHz | 0.860 | 0.66 | 400 | Orange |
| 220 | $\pm 2, \pm 5, \pm 10\%$ | 100 | 50 @ 250MHz | 0.850 | 0.70 | 400 | Gray |
| 240 | $\pm 2, \pm 5, \pm 10\%$ | 100 | 44 @ 250MHz | 0.690 | 1.00 | 350 | Red |
| 250 | $\pm 2, \pm 5, \pm 10\%$ | 100 | 50 @ 250MHz | 0.680 | 1.00 | 350 | Green |
| 270 | $\pm 2, \pm 5, \pm 10\%$ | 100 | 48 @ 250MHz | 0.650 | 1.00 | 350 | White |
| 300 | $\pm 2, \pm 5, \pm 10\%$ | 100 | 48 @ 250MHz | 0.620 | 1.20 | 330 | Yellow |
| 330 | $\pm 2, \pm 5, \pm 10\%$ | 100 | 48 @ 250MHz | 0.600 | 1.40 | 310 | Black |
| 360 | $\pm 2, \pm 5, \pm 10\%$ | 100 | 48 @ 250MHz | 0.580 | 1.45 | 300 | Green |
| 390 | $\pm 2, \pm 5, \pm 10\%$ | 100 | 48 @ 250MHz | 0.560 | 1.50 | 290 | Brown |
| 430 | $\pm 2, \pm 5, \pm 10\%$ | 50 | 33 @ 100MHz | 0.430 | 1.70 | 230 | Blue |
| 470 | $\pm 2, \pm 5, \pm 10\%$ | 50 | 33 @ 100MHz | 0.375 | 1.70 | 250 | Red |
| 560 | $\pm 2, \pm 5, \pm 10\%$ | 25 | 23 @ 50MHz | 0.340 | 1.90 | 230 | Orange |
| 600 | $\pm 2, \pm 5, \pm 10\%$ | 25 | 23 @ 50MHz | 0.260 | 1.60 | 450 | White |
| 620 | $\pm 2, \pm 5, \pm 10\%$ | 25 | 23 @ 50MHz | 0.220 | 2.20 | 210 | Yellow |
| 680 | $\pm 2, \pm 5, \pm 10\%$ | 25 | 23 @ 50MHz | 0.200 | 2.20 | 190 | Green |
| 750 | $\pm 2, \pm 5, \pm 10\%$ | 25 | 23 @ 50MHz | 0.200 | 2.30 | 180 | Blue |
| 820 | $\pm 2, \pm 5, \pm 10\%$ | 25 | 23 @ 50MHz | 0.200 | 2.35 | 180 | Violet |
| 1000 | $\pm 2, \pm 5, \pm 10\%$ | 25 | 20 @ 50MHz | 0.100 | 2.50 | 170 | Gray |
| 1200 | $\pm 2, \pm 5, \pm 10\%$ | 7.9 | 18 @ 25MHz | 0.100 | 2.50 | 170 | White |
| 1500 | $\pm 2, \pm 5, \pm 10\%$ | 7.9 | 16 @ 25MHz | 0.100 | 2.50 | 170 | Black |
| 1800 | $\pm 2, \pm 5, \pm 10\%$ | 7.9 | 16 @ 7.9MHz | 0.080 | 2.50 | 170 | Brown |
| 2200 | $\pm 2, \pm 5, \pm 10\%$ | 7.9 | 16 @ 7.9MHz | 0.060 | 2.70 | 160 | Red |
| 2700 | $\pm 2, \pm 5, \pm 10\%$ | 7.9 | 16 @ 7.9MHz | 0.050 | 3.10 | 150 | Orange |
| 3300 | $\pm 2, \pm 5, \pm 10\%$ | 7.9 | 15 @ 7.9MHz | 0.040 | 4.40 | 90 | Blue |
| 4700 | $\pm 2, \pm 5, \pm 10\%$ | 7.9 | 15 @ 7.9MHz | 0.040 | 6.40 | 90 | Green |

Wire Wound Chip Inductor

LCWC Series



1008

| Inductance (nH) | Tolerance | L Freq. (MHz) | Quality Factor min. | SRF (GHz) min. | DCR (Ω) max. | IDC (mA) max. | Color Code |
|-----------------|--------------------------|---------------|---------------------|----------------|-----------------------|---------------|------------|
| *5.6 | $\pm 5, \pm 10\%$ | 50 | 50 @ 1500MHz | 4.000 | 0.15 | 1000 | Black |
| *10 | $\pm 2, \pm 5, \pm 10\%$ | 50 | 50 @ 500MHz | 4.100 | 0.08 | 1000 | Brown |
| *12 | $\pm 2, \pm 5, \pm 10\%$ | 50 | 50 @ 500MHz | 3.300 | 0.09 | 1000 | Red |
| *15 | $\pm 2, \pm 5, \pm 10\%$ | 50 | 50 @ 500MHz | 2.500 | 0.11 | 1000 | Orange |
| *18 | $\pm 2, \pm 5, \pm 10\%$ | 50 | 50 @ 350MHz | 2.400 | 0.12 | 1000 | Yellow |
| *22 | $\pm 2, \pm 5, \pm 10\%$ | 50 | 55 @ 350MHz | 2.400 | 0.12 | 1000 | Green |
| 24 | $\pm 2, \pm 5, \pm 10\%$ | 50 | 55 @ 350MHz | 1.900 | 0.13 | 1000 | Blue |
| *27 | $\pm 2, \pm 5, \pm 10\%$ | 50 | 55 @ 350MHz | 1.600 | 0.13 | 1000 | Violet |
| *33 | $\pm 2, \pm 5, \pm 10\%$ | 50 | 60 @ 350MHz | 1.600 | 0.14 | 1000 | Gray |
| 36 | $\pm 2, \pm 5, \pm 10\%$ | 50 | 60 @ 350MHz | 1.600 | 0.15 | 1000 | Orange |
| *39 | $\pm 2, \pm 5, \pm 10\%$ | 50 | 60 @ 350MHz | 1.500 | 0.15 | 1000 | White |
| *47 | $\pm 2, \pm 5, \pm 10\%$ | 50 | 65 @ 350MHz | 1.500 | 0.16 | 1000 | Black |
| *56 | $\pm 2, \pm 5, \pm 10\%$ | 50 | 65 @ 350MHz | 1.300 | 0.18 | 1000 | Brown |
| *62 | $\pm 2, \pm 5, \pm 10\%$ | 50 | 65 @ 350MHz | 1.250 | 0.20 | 1000 | Blue |
| *68 | $\pm 2, \pm 5, \pm 10\%$ | 50 | 65 @ 350MHz | 1.300 | 0.20 | 1000 | Red |
| 75 | $\pm 2, \pm 5, \pm 10\%$ | 50 | 60 @ 350MHz | 1.100 | 0.21 | 1000 | White |
| *82 | $\pm 2, \pm 5, \pm 10\%$ | 50 | 60 @ 350MHz | 1.000 | 0.22 | 1000 | Orange |
| 91 | $\pm 2, \pm 5, \pm 10\%$ | 50 | 50 @ 350MHz | 1.000 | 0.45 | 1000 | White |
| *100 | $\pm 2, \pm 5, \pm 10\%$ | 25 | 60 @ 350MHz | 1.000 | 0.56 | 650 | Yellow |
| *120 | $\pm 2, \pm 5, \pm 10\%$ | 25 | 60 @ 350MHz | 0.950 | 0.63 | 650 | Green |
| *150 | $\pm 2, \pm 5, \pm 10\%$ | 25 | 45 @ 100MHz | 0.850 | 0.70 | 800 | Blue |
| *180 | $\pm 2, \pm 5, \pm 10\%$ | 25 | 45 @ 100MHz | 0.750 | 0.77 | 620 | Violet |
| *220 | $\pm 2, \pm 5, \pm 10\%$ | 25 | 45 @ 100MHz | 0.700 | 0.84 | 500 | Gray |
| *240 | $\pm 2, \pm 5, \pm 10\%$ | 25 | 45 @ 100MHz | 0.650 | 0.88 | 500 | White |
| *270 | $\pm 2, \pm 5, \pm 10\%$ | 25 | 45 @ 100MHz | 0.600 | 0.91 | 690 | Black |
| *300 | $\pm 2, \pm 5, \pm 10\%$ | 25 | 45 @ 100MHz | 0.585 | 1.00 | 450 | Brown |
| *330 | $\pm 2, \pm 5, \pm 10\%$ | 25 | 45 @ 100MHz | 0.570 | 1.05 | 450 | Red |
| *360 | $\pm 2, \pm 5, \pm 10\%$ | 25 | 45 @ 100MHz | 0.530 | 1.10 | 470 | Orange |
| *390 | $\pm 2, \pm 5, \pm 10\%$ | 25 | 45 @ 100MHz | 0.500 | 1.12 | 630 | Yellow |
| *430 | $\pm 2, \pm 5, \pm 10\%$ | 25 | 45 @ 100MHz | 0.480 | 1.15 | 470 | Green |
| *470 | $\pm 2, \pm 5, \pm 10\%$ | 25 | 45 @ 100MHz | 0.450 | 1.19 | 470 | Blue |
| *560 | $\pm 2, \pm 5, \pm 10\%$ | 25 | 45 @ 100MHz | 0.415 | 1.33 | 580 | Violet |
| *620 | $\pm 2, \pm 5, \pm 10\%$ | 25 | 45 @ 100MHz | 0.375 | 1.40 | 300 | Gray |
| *680 | $\pm 2, \pm 5, \pm 10\%$ | 25 | 45 @ 100MHz | 0.375 | 1.47 | 540 | White |
| *750 | $\pm 2, \pm 5, \pm 10\%$ | 25 | 45 @ 100MHz | 0.360 | 1.54 | 360 | Black |
| *820 | $\pm 2, \pm 5, \pm 10\%$ | 25 | 45 @ 100MHz | 0.350 | 1.61 | 400 | Brown |
| *910 | $\pm 2, \pm 5, \pm 10\%$ | 25 | 35 @ 50MHz | 0.320 | 1.68 | 380 | Red |
| *1000 | $\pm 2, \pm 5, \pm 10\%$ | 25 | 35 @ 50MHz | 0.290 | 1.75 | 370 | Orange |
| *1200 | $\pm 2, \pm 5, \pm 10\%$ | 7.9 | 35 @ 50MHz | 0.250 | 2.00 | 310 | Yellow |
| *1500 | $\pm 2, \pm 5, \pm 10\%$ | 7.9 | 28 @ 50MHz | 0.200 | 2.30 | 330 | Green |
| *1800 | $\pm 2, \pm 5, \pm 10\%$ | 7.9 | 28 @ 50MHz | 0.160 | 2.60 | 300 | Blue |
| *2200 | $\pm 2, \pm 5, \pm 10\%$ | 7.9 | 28 @ 50MHz | 0.160 | 2.80 | 280 | Violet |
| *2700 | $\pm 2, \pm 5, \pm 10\%$ | 7.9 | 22 @ 25MHz | 0.140 | 3.20 | 290 | Gray |
| *3300 | $\pm 2, \pm 5, \pm 10\%$ | 7.9 | 22 @ 25MHz | 0.110 | 3.40 | 290 | White |
| *3900 | $\pm 2, \pm 5, \pm 10\%$ | 7.9 | 18 @ 25MHz | 0.100 | 3.60 | 260 | Black |
| *4700 | $\pm 2, \pm 5, \pm 10\%$ | 7.9 | 18 @ 25MHz | 0.090 | 4.00 | 260 | Brown |
| 5600 | $\pm 2, \pm 5, \pm 10\%$ | 7.9 | 16 @ 7.96MHz | 0.020 | 4.00 | 240 | Red |
| 6800 | $\pm 2, \pm 5, \pm 10\%$ | 7.9 | 15 @ 7.96MHz | 0.040 | 4.90 | 200 | Orange |
| 8200 | $\pm 2, \pm 5, \pm 10\%$ | 7.9 | 15 @ 7.96MHz | 0.025 | 6.00 | 170 | Yellow |
| 10000 | $\pm 2, \pm 5, \pm 10\%$ | 2.52 | 15 @ 7.96MHz | 0.020 | 9.00 | 150 | Green |
| 12000 | $\pm 2, \pm 5, \pm 10\%$ | 2.52 | 15 @ 7.96MHz | 0.018 | 10.5 | 130 | Blue |
| 15000 | $\pm 2, \pm 5, \pm 10\%$ | 2.52 | 15 @ 7.96MHz | 0.015 | 11.5 | 120 | Violet |

*Test Methods | Instrument: Network | Spectrum Analyzer

7

Wire Wound Chip Inductor

LCWC Series



1206

| Inductance (nH) | Tolerance | L Freq. (MHz) | Quality Factor min. | SRF (GHz) min. | DCR (Ω) max. | IDC (mA) max. | Color Code |
|-----------------|--------------------------|---------------|---------------------|----------------|-----------------------|---------------|------------|
| 6.8 | $\pm 5, \pm 10\%$ | 100 | 30 @ 300MHz | 5.50 | 0.07 | 1000 | Brown |
| 10 | $\pm 5, \pm 10\%$ | 100 | 40 @ 300MHz | 4.00 | 0.08 | 1000 | Red |
| 12 | $\pm 5, \pm 10\%$ | 100 | 40 @ 300MHz | 3.20 | 0.08 | 1000 | Orange |
| 15 | $\pm 5, \pm 10\%$ | 100 | 40 @ 300MHz | 3.20 | 0.10 | 1000 | Yellow |
| 18 | $\pm 5, \pm 10\%$ | 100 | 50 @ 300MHz | 2.80 | 0.10 | 1000 | Green |
| 22 | $\pm 5, \pm 10\%$ | 100 | 50 @ 300MHz | 2.20 | 0.10 | 1000 | Blue |
| 24 | $\pm 5, \pm 10\%$ | 100 | 50 @ 300MHz | 2.00 | 0.10 | 1000 | Red |
| 27 | $\pm 2, \pm 5, \pm 10\%$ | 100 | 50 @ 300MHz | 1.80 | 0.11 | 1000 | Violet |
| 33 | $\pm 2, \pm 5, \pm 10\%$ | 100 | 55 @ 300MHz | 1.80 | 0.11 | 1000 | Gray |
| 39 | $\pm 2, \pm 5, \pm 10\%$ | 100 | 55 @ 300MHz | 1.80 | 0.12 | 1000 | White |
| 47 | $\pm 2, \pm 5, \pm 10\%$ | 100 | 55 @ 300MHz | 1.50 | 0.13 | 1000 | Black |
| 56 | $\pm 2, \pm 5, \pm 10\%$ | 100 | 55 @ 300MHz | 1.45 | 0.14 | 1000 | Brown |
| 62 | $\pm 2, \pm 5, \pm 10\%$ | 100 | 55 @ 300MHz | 1.20 | 0.20 | 1000 | Violet |
| 68 | $\pm 2, \pm 5, \pm 10\%$ | 100 | 55 @ 300MHz | 1.20 | 0.26 | 950 | Red |
| 82 | $\pm 2, \pm 5, \pm 10\%$ | 100 | 55 @ 300MHz | 1.20 | 0.21 | 920 | Orange |
| 91 | $\pm 2, \pm 5, \pm 10\%$ | 100 | 55 @ 300MHz | 1.10 | 0.24 | 900 | White |
| 100 | $\pm 2, \pm 5, \pm 10\%$ | 100 | 55 @ 300MHz | 1.10 | 0.26 | 850 | Yellow |
| 120 | $\pm 2, \pm 5, \pm 10\%$ | 100 | 55 @ 300MHz | 0.75 | 0.26 | 800 | Green |
| 150 | $\pm 2, \pm 5, \pm 10\%$ | 100 | 60 @ 300MHz | 0.95 | 0.31 | 750 | Blue |
| 180 | $\pm 2, \pm 5, \pm 10\%$ | 50 | 55 @ 300MHz | 0.90 | 0.43 | 700 | Violet |
| 220 | $\pm 2, \pm 5, \pm 10\%$ | 50 | 55 @ 300MHz | 0.76 | 0.50 | 670 | Gray |
| 270 | $\pm 2, \pm 5, \pm 10\%$ | 50 | 55 @ 300MHz | 0.74 | 0.56 | 630 | White |
| 300 | $\pm 2, \pm 5, \pm 10\%$ | 50 | 50 @ 150MHz | 0.68 | 0.60 | 600 | Green |
| 330 | $\pm 2, \pm 5, \pm 10\%$ | 50 | 45 @ 150MHz | 0.65 | 0.62 | 590 | Black |
| 360 | $\pm 2, \pm 5, \pm 10\%$ | 50 | 45 @ 150MHz | 0.60 | 0.65 | 550 | Blue |
| 390 | $\pm 2, \pm 5, \pm 10\%$ | 50 | 45 @ 150MHz | 0.60 | 0.75 | 530 | Brown |
| 470 | $\pm 2, \pm 5, \pm 10\%$ | 50 | 45 @ 150MHz | 0.55 | 1.30 | 490 | Red |
| 560 | $\pm 2, \pm 5, \pm 10\%$ | 35 | 45 @ 150MHz | 0.47 | 1.34 | 460 | Orange |
| 620 | $\pm 2, \pm 5, \pm 10\%$ | 35 | 45 @ 150MHz | 0.47 | 1.58 | 460 | Gray |
| 680 | $\pm 2, \pm 5, \pm 10\%$ | 35 | 45 @ 150MHz | 0.45 | 1.58 | 430 | Yellow |
| 750 | $\pm 2, \pm 5, \pm 10\%$ | 35 | 45 @ 150MHz | 0.44 | 2.25 | 320 | White |
| 820 | $\pm 2, \pm 5, \pm 10\%$ | 35 | 45 @ 150MHz | 0.42 | 1.82 | 400 | Green |
| 910 | $\pm 2, \pm 5, \pm 10\%$ | 35 | 45 @ 150MHz | 0.41 | 2.95 | 310 | Green |
| 1000 | $\pm 2, \pm 5, \pm 10\%$ | 35 | 45 @ 150MHz | 0.40 | 2.80 | 320 | Blue |
| 1200 | $\pm 2, \pm 5, \pm 10\%$ | 35 | 45 @ 150MHz | 0.38 | 3.20 | 300 | Violet |

Wire Wound Chip Inductor

LCWC Series



LOW PROFILE ELECTRICAL SPECIFICATIONS

0805

| Inductance (nH) | Tolerance | L Freq. (MHz) | Quality Factor min. | SRF (GHz) min. | DCR (Ω) max. | IDC (mA) max. | Color Code |
|-----------------|--------------------------|---------------|---------------------|----------------|-----------------------|---------------|------------|
| 1.8 | $\pm 5\%$ | 250 | 55 @ 1500MHz | 9.40 | 0.03 | 800 | Black |
| 3.9 | $\pm 5, \pm 10\%$ | 250 | 60 @ 1000MHz | 6.10 | 0.06 | 800 | Brown |
| 4.7 | $\pm 5, \pm 10\%$ | 250 | 50 @ 1000MHz | 5.50 | 0.06 | 800 | Red |
| 6.8 | $\pm 5, \pm 10\%$ | 250 | 50 @ 1000MHz | 5.50 | 0.08 | 800 | Orange |
| 8.2 | $\pm 5, \pm 10\%$ | 250 | 50 @ 1000MHz | 4.80 | 0.08 | 800 | Yellow |
| 10 | $\pm 2, \pm 5, \pm 10\%$ | 250 | 55 @ 750MHz | 3.30 | 0.08 | 800 | Green |
| 12 | $\pm 2, \pm 5, \pm 10\%$ | 250 | 55 @ 750MHz | 3.80 | 0.10 | 800 | Blue |
| 15 | $\pm 2, \pm 5, \pm 10\%$ | 250 | 50 @ 500MHz | 2.95 | 0.10 | 800 | Violet |
| 18 | $\pm 2, \pm 5, \pm 10\%$ | 250 | 50 @ 500MHz | 3.10 | 0.13 | 800 | Gray |
| 22 | $\pm 2, \pm 5, \pm 10\%$ | 250 | 50 @ 500MHz | 2.90 | 0.15 | 800 | Whit |
| 27 | $\pm 2, \pm 5, \pm 10\%$ | 250 | 50 @ 500MHz | 2.45 | 0.23 | 600 | Black |
| 33 | $\pm 2, \pm 5, \pm 10\%$ | 250 | 50 @ 500MHz | 2.35 | 0.28 | 600 | Brown |
| 39 | $\pm 2, \pm 5, \pm 10\%$ | 250 | 50 @ 500MHz | 2.20 | 0.33 | 600 | Red |
| 47 | $\pm 2, \pm 5, \pm 10\%$ | 200 | 50 @ 500MHz | 2.00 | 0.39 | 600 | Orange |
| 56 | $\pm 2, \pm 5, \pm 10\%$ | 200 | 50 @ 500MHz | 1.85 | 0.39 | 500 | Yellow |
| 68 | $\pm 2, \pm 5, \pm 10\%$ | 200 | 50 @ 500MHz | 1.50 | 0.40 | 500 | Green |
| 82 | $\pm 2, \pm 5, \pm 10\%$ | 150 | 50 @ 500MHz | 1.50 | 0.44 | 500 | Blue |
| 100 | $\pm 2, \pm 5, \pm 10\%$ | 150 | 50 @ 500MHz | 1.20 | 0.64 | 400 | Violet |
| 120 | $\pm 2, \pm 5, \pm 10\%$ | 150 | 40 @ 250MHz | 1.15 | 0.68 | 300 | Gray |
| 150 | $\pm 2, \pm 5, \pm 10\%$ | 150 | 40 @ 250MHz | 1.05 | 0.80 | 300 | Whit |
| 1000 | $\pm 2, \pm 5, \pm 10\%$ | 25 | 16 @ 50MHz | 0.08 | 3.50 | 170 | Black |

1008

| Inductance (nH) | Tolerance | L Freq. (MHz) | Quality Factor min. | SRF (GHz) min. | DCR (Ω) max. | IDC (mA) max. | Color Code |
|-----------------|--------------------------|---------------|---------------------|----------------|-----------------------|---------------|------------|
| 3.3 | $\pm 5, \pm 10\%$ | 50 | 42 @ 1500MHz | 6.00 | 0.03 | 1000 | White |
| 4.2 | $\pm 5, \pm 10\%$ | 50 | 42 @ 1500MHz | 6.00 | 0.15 | 1000 | Black |
| 6.8 | $\pm 5, \pm 10\%$ | 50 | 50 @ 1500MHz | 5.40 | 0.17 | 1000 | Brown |
| 8.2 | $\pm 5, \pm 10\%$ | 50 | 50 @ 1500MHz | 5.00 | 0.22 | 1000 | Red |
| 15 | $\pm 5, \pm 10\%$ | 50 | 57 @ 500MHz | 3.00 | 0.22 | 1000 | Orange |
| 18 | $\pm 5, \pm 10\%$ | 50 | 50 @ 350MHz | 2.40 | 0.12 | 1000 | Gray |
| 20 | $\pm 5, \pm 10\%$ | 50 | 72 @ 500MHz | 2.40 | 0.33 | 1000 | Yellow |
| 27 | $\pm 5, \pm 10\%$ | 50 | 50 @ 350MHz | 1.60 | 0.13 | 850 | Green |
| 30 | $\pm 5, \pm 10\%$ | 50 | 69 @ 500MHz | 2.40 | 0.38 | 600 | Blue |
| 40 | $\pm 5, \pm 10\%$ | 50 | 67 @ 500MHz | 2.00 | 0.43 | 600 | Violet |
| 50 | $\pm 2, \pm 5, \pm 10\%$ | 50 | 72 @ 500MHz | 1.90 | 0.48 | 600 | Gray |
| 60 | $\pm 2, \pm 5, \pm 10\%$ | 50 | 75 @ 500MHz | 1.80 | 0.52 | 600 | White |
| 70 | $\pm 2, \pm 5, \pm 10\%$ | 50 | 68 @ 500MHz | 1.70 | 0.55 | 510 | Black |
| 80 | $\pm 2, \pm 5, \pm 10\%$ | 50 | 75 @ 500MHz | 1.40 | 0.56 | 510 | Brown |
| 180 | $\pm 2, \pm 5, \pm 10\%$ | 50 | 50 @ 350MHz | 0.90 | 0.40 | 450 | Blue |
| 560 | $\pm 2, \pm 5, \pm 10\%$ | 25 | 40 @ 100MHz | 0.415 | 1.33 | 400 | Red |

Wire Wound Chip Inductor

LCWC Series



HIGH CURRENT ELECTRICAL SPECIFICATIONS

0603

| Inductance (nH) | Tolerance | L Freq. (MHz) | Quality Factor min. | SRF (GHz) min. | DCR (Ω) max. | IDC (mA) max. | Color Code |
|-----------------|--------------------------|---------------|---------------------|----------------|-----------------------|---------------|------------|
| 1.6 | $\pm 5, \pm 10\%$ | 250 | 24 | 12.50 | 0.030 | 2400 | Black |
| 3.6 | $\pm 5, \pm 10\%$ | 250 | 24 | 5.90 | 0.048 | 2300 | Brown |
| 3.9 | $\pm 5, \pm 10\%$ | 250 | 25 | 5.90 | 0.054 | 2200 | Red |
| 6.8 | $\pm 5, \pm 10\%$ | 250 | 35 | 5.80 | 0.054 | 2100 | Orange |
| 7.5 | $\pm 5, \pm 10\%$ | 250 | 38 | 3.70 | 0.059 | 2100 | Yellow |
| 8.2 | $\pm 5, \pm 10\%$ | 250 | 38 | 3.70 | 0.060 | 2000 | White |
| 10 | $\pm 2, \pm 5, \pm 10\%$ | 250 | 38 | 3.70 | 0.071 | 2000 | Green |
| 12 | $\pm 2, \pm 5, \pm 10\%$ | 250 | 38 | 3.00 | 0.075 | 2000 | Blue |
| 15 | $\pm 2, \pm 5, \pm 10\%$ | 250 | 38 | 2.80 | 0.080 | 1900 | Violet |
| 18 | $\pm 2, \pm 5, \pm 10\%$ | 250 | 40 | 2.80 | 0.099 | 1900 | Gray |
| 22 | $\pm 2, \pm 5, \pm 10\%$ | 250 | 42 | 2.40 | 0.099 | 1800 | White |
| 24 | $\pm 2, \pm 5, \pm 10\%$ | 250 | 42 | 2.40 | 0.105 | 1800 | Black |

HIGH Q ELECTRICAL SPECIFICATIONS

0805

| Inductance (nH) | Tolerance | L Freq. (MHz) | Quality Factor min. | SRF (GHz) min. | DCR (Ω) max. | IDC (mA) max. | Color Code |
|-----------------|--------------------------|---------------|---------------------|----------------|-----------------------|---------------|------------|
| 2.5 | $\pm 5, \pm 10\%$ | 250 | 80 @ 1500MHz | 6.00 | 0.020 | 1600 | Black |
| 5.6 | $\pm 5, \pm 10\%$ | 250 | 98 @ 1500MHz | 6.00 | 0.035 | 1600 | Brown |
| 6.2 | $\pm 5, \pm 10\%$ | 250 | 88 @ 1000MHz | 4.75 | 0.035 | 1600 | Red |
| 6.8 | $\pm 5, \pm 10\%$ | 250 | 80 @ 1000MHz | 4.40 | 0.035 | 1600 | White |
| 8.2 | $\pm 5, \pm 10\%$ | 250 | 75 @ 1000MHz | 3.00 | 0.075 | 1000 | Gray |
| 10 | $\pm 5, \pm 10\%$ | 250 | 80 @ 1000MHz | 3.00 | 0.060 | 1600 | Black |
| 12 | $\pm 5, \pm 10\%$ | 250 | 80 @ 1000MHz | 3.00 | 0.045 | 1600 | Orange |
| 15 | $\pm 2, \pm 5, \pm 10\%$ | 250 | 80 @ 1000MHz | 2.80 | 0.100 | 1200 | Black |
| 16 | $\pm 2, \pm 5, \pm 10\%$ | 250 | 72 @ 500MHz | 2.95 | 0.060 | 1500 | Yellow |
| 18 | $\pm 2, \pm 5, \pm 10\%$ | 250 | 75 @ 500MHz | 2.55 | 0.060 | 1400 | Green |
| 20 | $\pm 2, \pm 5, \pm 10\%$ | 250 | 70 @ 500MHz | 2.05 | 0.055 | 1400 | Blue |
| 22 | $\pm 2, \pm 5, \pm 10\%$ | 250 | 80 @ 500MHz | 2.00 | 0.100 | 1200 | Black |
| 27 | $\pm 2, \pm 5, \pm 10\%$ | 250 | 75 @ 500MHz | 2.00 | 0.070 | 1300 | Violet |
| 30 | $\pm 2, \pm 5, \pm 10\%$ | 250 | 65 @ 500MHz | 1.95 | 0.095 | 1200 | Gray |
| 39 | $\pm 2, \pm 5, \pm 10\%$ | 250 | 65 @ 500MHz | 1.60 | 0.110 | 1100 | White |
| 48 | $\pm 2, \pm 5, \pm 10\%$ | 200 | 65 @ 500MHz | 1.40 | 0.095 | 1200 | Black |
| 51 | $\pm 2, \pm 5, \pm 10\%$ | 200 | 65 @ 500MHz | 1.40 | 0.120 | 1000 | Brown |

1008

| Inductance (nH) | Tolerance | L Freq. (MHz) | Quality Factor min. | SRF (GHz) min. | DCR (Ω) max. | IDC (mA) max. | Color Code |
|-----------------|--------------------------|---------------|---------------------|----------------|-----------------------|---------------|------------|
| 3.0 | $\pm 5, \pm 10\%$ | 50 | 70 @ 1500MHz | 6.00 | 0.04 | 1600 | Black |
| 3.9 | $\pm 5, \pm 10\%$ | 50 | 75 @ 1500MHz | 6.00 | 0.05 | 1600 | White |
| 4.1 | $\pm 5, \pm 10\%$ | 50 | 75 @ 1500MHz | 6.00 | 0.05 | 1600 | Brown |
| 7.8 | $\pm 5, \pm 10\%$ | 50 | 75 @ 500MHz | 3.80 | 0.05 | 1600 | Red |
| 10 | $\pm 2, \pm 5, \pm 10\%$ | 50 | 60 @ 500MHz | 3.60 | 0.06 | 1600 | Orange |
| 12 | $\pm 2, \pm 5, \pm 10\%$ | 50 | 70 @ 500MHz | 2.80 | 0.06 | 1500 | Yellow |
| 18 | $\pm 2, \pm 5, \pm 10\%$ | 50 | 62 @ 350MHz | 2.70 | 0.07 | 1400 | Green |
| 22 | $\pm 2, \pm 5, \pm 10\%$ | 50 | 62 @ 350MHz | 2.05 | 0.07 | 1400 | Blue |
| 33 | $\pm 2, \pm 5, \pm 10\%$ | 50 | 75 @ 350MHz | 1.70 | 0.09 | 1300 | Violet |
| 39 | $\pm 2, \pm 5, \pm 10\%$ | 50 | 75 @ 350MHz | 1.30 | 0.09 | 1300 | Gray |
| 47 | $\pm 2, \pm 5, \pm 10\%$ | 50 | 75 @ 350MHz | 1.45 | 0.12 | 1200 | White |
| 56 | $\pm 2, \pm 5, \pm 10\%$ | 50 | 75 @ 350MHz | 1.23 | 0.12 | 1200 | Black |
| 68 | $\pm 2, \pm 5, \pm 10\%$ | 50 | 80 @ 350MHz | 1.15 | 0.13 | 1100 | Brown |
| 82 | $\pm 2, \pm 5, \pm 10\%$ | 50 | 80 @ 350MHz | 1.06 | 0.16 | 1100 | Red |
| 100 | $\pm 2, \pm 5, \pm 10\%$ | 50 | 50 @ 350MHz | 0.82 | 0.16 | 1000 | Orange |

Wire Wound Chip Inductor



LCWC Series

ENVIRONMENTAL CHARACTERISTICS

MECHANICAL PERFORMANCE TEST

| Items | Requirement | Test Methods |
|-----------------------|--|--|
| Inductance | Refer to standard electrical characteristic spec. | HP4286 |
| Q | | HP4286 |
| SRF | | HP4287 |
| DC Resistance RDC | | Micro-Ohm meter (Gom-801G) |
| Rated Current IDC | | Applied the current to coils, The inductance change should be less than 10% to initial value |
| Over Load | Inductors shall have no evidence of electrical and mechanical damage | Applied 2 times of rated allowed DC current to inductor for a period of 5 minutes |
| Withstanding Voltage | Inductors shall be no evidence of electrical and mechanical damage. | AC voltage of 500 VAC applied between inductors terminal and case for 1 min. |
| Insulation Resistance | 1000M ohm min. | 100 VDC applied between inductor terminal and case and case |

MECHANICAL PERFORMANCE TEST

| Items | Requirement | Test Methods |
|--------------------------------|--|--|
| Vibration | Appearance: No damage L change: within $\pm 5\%$ Q change: within $\pm 10\%$ | Test device shall be soldered on the substrate Oscillation Frequency: 10 to 55 to 10Hz for 1 min. Amplitude: 1.5 mm Time: 2 hrs for each axis (X, Y & Z), total 6 hrs |
| Resistance to Soldering Heat | | Solder Temperature: $260 \pm 50^\circ\text{C}$ Immersion Time: 10 ± 2 seconds |
| Component Adhesion (Push Test) | 1 lbs. For 0402 2 lbs. For 0603 3 lbs. For the rest | The device should be soldered (260 ± 5 for 10 seconds) to a tinned copper subs rate. A dynamiter force gauge should be applied to the side of the component. The device must with stand a minimum force of 2 or 4 pounds without a failure of adhesion on termination |
| Drop | No damage | Dropping chip by each side and each corner. Drop 10 times in total Drop height: 100 cm Drop weight: 125 g |
| Solderability | 90% covered with solder | Inductor shall be dipped in a melted solder bath at 245 ± 5 for 3 seconds |
| Resistance to Solvent | No damage on appearance and marking | MIL-STD202F, Method 215D |

CLIMATIC TEST

| Items | Requirement | Test Methods | | | | | | | | | | | | | | | |
|----------------------------|---|--|-------------|----------------------------------|-------------|---|-------------|----|---|------------|----|---|-------------|----|---|------------|----|
| Temperature Characteristic | Appearance: No damage L change: within $\pm 10\%$ Q change: within $\pm 20\%$ | -40 ~ +125°C | | | | | | | | | | | | | | | |
| Humidity | | Temperature: $40 \pm 2^\circ\text{C}$ Relative Humidity: 90 ~ 95% Time: 96 ± 2 hrs Measured after exposure in the room condition for 2 hrs | | | | | | | | | | | | | | | |
| Low Temperature Storage | | Temperature: $-40 \pm 2^\circ\text{C}$ Time: 96 ± 2 hrs Inductors are tested after 1 hour at room temperature | | | | | | | | | | | | | | | |
| Thermal Shock | | One cycle: <table border="1" style="margin-left: 20px;"> <thead> <tr> <th>Step</th> <th>Temperature ($^\circ\text{C}$)</th> <th>Time (min.)</th> </tr> </thead> <tbody> <tr> <td>1</td> <td>-25 ± 3</td> <td>30</td> </tr> <tr> <td>2</td> <td>25 ± 2</td> <td>15</td> </tr> <tr> <td>3</td> <td>125 ± 3</td> <td>30</td> </tr> <tr> <td>4</td> <td>25 ± 2</td> <td>15</td> </tr> </tbody> </table> | Step | Temperature ($^\circ\text{C}$) | Time (min.) | 1 | -25 ± 3 | 30 | 2 | 25 ± 2 | 15 | 3 | 125 ± 3 | 30 | 4 | 25 ± 2 | 15 |
| Step | | Temperature ($^\circ\text{C}$) | Time (min.) | | | | | | | | | | | | | | |
| 1 | | -25 ± 3 | 30 | | | | | | | | | | | | | | |
| 2 | | 25 ± 2 | 15 | | | | | | | | | | | | | | |
| 3 | 125 ± 3 | 30 | | | | | | | | | | | | | | | |
| 4 | 25 ± 2 | 15 | | | | | | | | | | | | | | | |
| High Temperature Storage | Temperature: $125 \pm 2^\circ\text{C}$ Time: 96 ± 2 hrs Measured after exposure in the room condition for 1 hour | | | | | | | | | | | | | | | | |
| High Temperature Load Life | Temperature: $85 \pm 2^\circ\text{C}$ Time: 1000 ± 12 hrs Load: Allowed DC current | | | | | | | | | | | | | | | | |
| Damp Heat with Load | Temperature: $40 \pm 2^\circ\text{C}$ Relative Humidity: 90 ~ 95% Time: 1000 ± 12 hrs Load: Allowed DC current | | | | | | | | | | | | | | | | |

7



Wire Wound Chip Inductor

LCWC Series



REEL DIMENSIONS AND PACKAGING QUANTITY

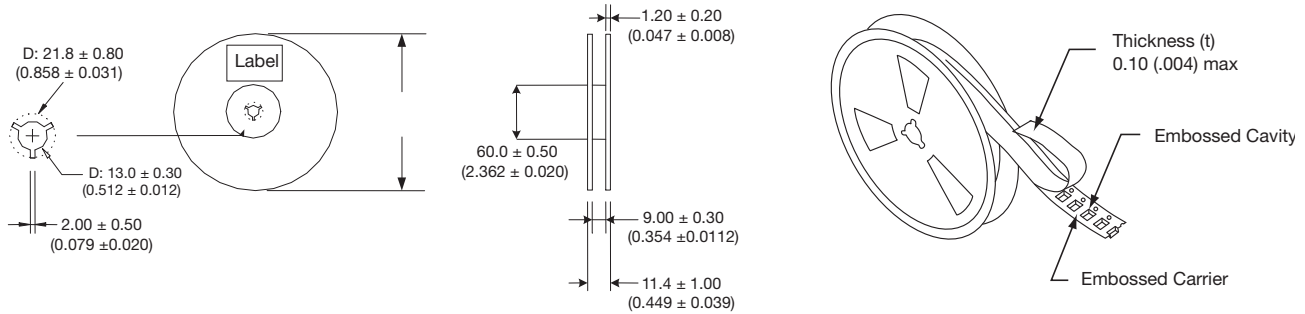

PAPER TAPE SPECIFICATION AND PACKAGING QUANTITY

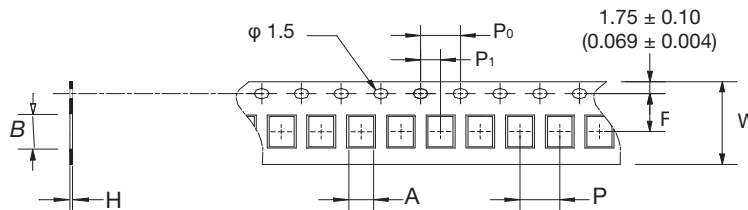

mm (inches)

| Type | A | B | H | F | P | P ₀ | P ₁ | W | Reel (EA) |
|----------|-----------------|-----------------|-----------------|-----------------|-----------------|-----------------|-----------------|-----------------|-----------|
| LCWC0402 | 0.72 (0.028) | 1.19 (0.047) | 0.60 (0.024) | 3.50 (0.138) | 4.00 (0.157) | 4.00 (0.147) | 2.00 (0.079) | 8.00 (0.315) | 4,000 |
| LCWC0603 | 1.35 (0.053) | 1.95 (0.077) | 0.95 (0.037) | 3.50 (0.138) | 4.00 (0.157) | 4.00 (0.147) | 2.00 (0.079) | 8.00 (0.315) | 4,000 |

EMBOSSED PLASTIC PAPER TAPE SPECIFICATION AND PACKAGING QUANTITY

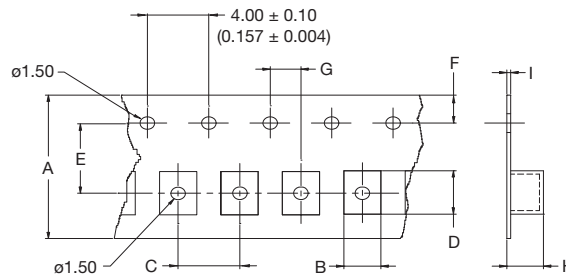

mm (inches)

| Type | A | B | C | D | E | F | G | H | I | Reel (EA) |
|--------------|--------------------------------|--------------------------------|--------------------------------|--------------------------------|--------------------------------|--------------------------------|--------------------------------|--------------------------------|--------------------------------|-----------|
| LCWC0805 | 8.00 ± 0.20 (0.315 ± 0.008) | 1.85 ± 0.10 (0.073 ± 0.073) | 4.00 ± 0.10 (0.157 ± 0.073) | 2.30 ± 0.10 (0.091 ± 0.073) | 3.50 ± 0.05 (0.138 ± 0.002) | 1.75 ± 0.10 (0.069 ± 0.073) | 2.00 ± 0.05 (0.079 ± 0.002) | 1.45 ± 0.05 (0.057 ± 0.002) | 0.23 ± 0.05 (0.009 ± 0.002) | 2,000 |
| LCWC0805 (R) | 8.00 ± 0.20 (0.315 ± 0.008) | 1.80 ± 0.10 (0.071 ± 0.073) | 4.00 ± 0.10 (0.157 ± 0.073) | 2.30 ± 0.10 (0.091 ± 0.073) | 3.50 ± 0.05 (0.138 ± 0.002) | 1.75 ± 0.10 (0.069 ± 0.073) | 2.00 ± 0.05 (0.079 ± 0.002) | 0.90 ± 0.05 (0.035 ± 0.002) | 0.23 ± 0.05 (0.009 ± 0.002) | 2,000 |
| LCWC0805 (Q) | 8.00 ± 0.20 (0.315 ± 0.008) | 1.85 ± 0.10 (0.073 ± 0.073) | 4.00 ± 0.10 (0.157 ± 0.073) | 2.30 ± 0.10 (0.091 ± 0.073) | 3.50 ± 0.05 (0.138 ± 0.002) | 1.75 ± 0.10 (0.069 ± 0.073) | 2.00 ± 0.05 (0.079 ± 0.002) | 1.45 ± 0.05 (0.057 ± 0.002) | 0.23 ± 0.05 (0.009 ± 0.002) | 2,000 |
| LCWC1206 | 8.00 ± 0.20 (0.315 ± 0.008) | 1.95 ± 0.10 (0.077 ± 0.073) | 4.00 ± 0.10 (0.157 ± 0.073) | 3.50 ± 0.10 (0.138 ± 0.073) | 3.50 ± 0.05 (0.138 ± 0.002) | 1.75 ± 0.10 (0.069 ± 0.073) | 2.00 ± 0.05 (0.079 ± 0.002) | 1.50 ± 0.05 (0.059 ± 0.002) | 0.23 ± 0.05 (0.009 ± 0.002) | 2,000 |
| LCWC1008 | 8.00 ± 0.20 (0.315 ± 0.008) | 2.70 ± 0.10 (0.106 ± 0.073) | 4.00 ± 0.10 (0.157 ± 0.073) | 2.80 ± 0.10 (0.110 ± 0.073) | 3.50 ± 0.05 (0.138 ± 0.002) | 1.75 ± 0.10 (0.069 ± 0.073) | 2.00 ± 0.05 (0.079 ± 0.002) | 2.00 ± 0.05 (0.079 ± 0.002) | 0.23 ± 0.05 (0.009 ± 0.002) | 2,000 |
| LCWC1008 (R) | 8.00 ± 0.20 (0.315 ± 0.008) | 2.70 ± 0.10 (0.106 ± 0.073) | 4.00 ± 0.10 (0.157 ± 0.073) | 2.80 ± 0.10 (0.110 ± 0.073) | 3.50 ± 0.05 (0.138 ± 0.002) | 1.75 ± 0.10 (0.069 ± 0.073) | 2.00 ± 0.05 (0.079 ± 0.002) | 1.50 ± 0.05 (0.059 ± 0.002) | 0.23 ± 0.05 (0.009 ± 0.002) | 2,000 |
| LCWC1008 (Q) | 8.00 ± 0.20 (0.315 ± 0.008) | 2.70 ± 0.10 (0.106 ± 0.073) | 4.00 ± 0.10 (0.157 ± 0.073) | 2.80 ± 0.10 (0.110 ± 0.073) | 3.50 ± 0.05 (0.138 ± 0.002) | 1.75 ± 0.10 (0.069 ± 0.073) | 2.00 ± 0.05 (0.079 ± 0.002) | 2.00 ± 0.05 (0.079 ± 0.002) | 0.23 ± 0.05 (0.009 ± 0.002) | 2,000 |





RF/Microwave Capacitors

RF/Microwave Multilayer Capacitors (MLC)

RF/Microwave C0G (NP0) Capacitors

RF/Microwave “U” Series Designer Kits

Microwave MLCs



UQ Series High Q Ultra Low ESR MLC

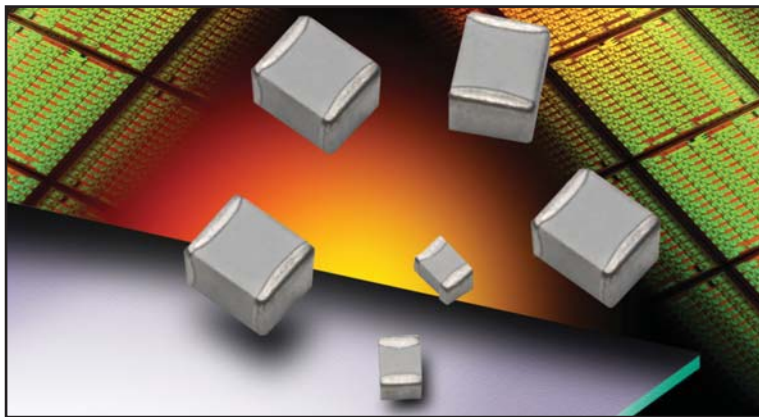

FEATURES:

- Ultra Low ESR
- High Q
- High Self Resonance
- Capacitance Range 0.1 pF to 1000 pF

APPLICATIONS:

- RF Power Amplifiers
- Low Noise Amplifiers
- Filter Networks
- MRI Systems

HOW TO ORDER

| | | | | | | | | |
|-----------------------------------|---|---|--|---|---|---|--|---|
| <p>UQ</p> <p>AVX Style</p> | <p>CB</p> <p>Case Size CA = 0605 CB = 1210 CR = 0709 CL = 0402 CS = 0603 CF = 0805</p> <p>See mechanical dimensions below</p> | <p>7</p> <p>Voltage Code 5 = 50V 1 = 100V 2 = 200V V = 250V 9 = 300V 7 = 500V</p> | <p>A</p> <p>Temperature Coefficient Code A = 0±30ppm/°C</p> | <p>100</p> <p>Capacitance EIA Capacitance Code in pF. First two digits = significant figures or "R" for decimal place. Third digit = number of zeros or after "R" significant figures.</p> | <p>J</p> <p>Capacitance Tolerance Code A = ±.05 pF B = ±.1 pF C = ±.25 pF D = ±.5 pF F = ±1% G = ±2% J = ±5% K = ±10% M = ±20%</p> | <p>A</p> <p>Failure Rate Code A = Not Applicable</p> | <p>T</p> <p>Termination Style Code J = Nickel Barrier Sn/Pb (60/40) **T = 100% Tin **C = Non-Magnetic Barrier/Tin</p> | <p>ME</p> <p>Packaging Code ME = 7" Reel Marked (0605, 1210 & 0709 only) 2A = 7" Unmarked (0402, 0603, & 0805 only)</p> <p>* Vertical T&R available</p> |
|-----------------------------------|---|---|--|---|---|---|--|---|

****RoHS compliant**

MECHANICAL DIMENSIONS: inches (millimeters)

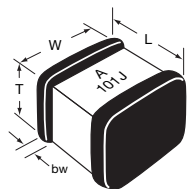

| Case | Length (L) | Width (W) | Thickness (T) | Band Width (bw) |
|------|---|--------------------------|------------------|---|
| UQCA | .055 + .015 - .010 (1.40+ .381 - .254) | .055±.015 (1.40±.381) | .057 (1.45) max. | .010 + .010 - .005 (.254 +.254 - .127) |
| UQCB | .110 + .020 - .010 (2.79 +.508 -.254) | .110±.015 (2.79±.381) | .102 (2.59) max. | .015±.010 (.381±.254) |
| UQCR | .070 ± .015 (1.78 ± .381) | .090±.010 (2.29±.254) | .115 (2.92) max. | .010 + .010 - .005 (.254 +.254 - .127) |
| UQCL | .040 ± .004 (1.02 ± .100) | .020±.004 (0.51±.100) | .024 (.600) max. | .010 ± .006 (0.25 ± 0.15) |
| UQCS | .063 ± .006 (1.60 ± 0.15) | .032±.006 (0.81±0.15) | .035 (.890) max. | .014 ± .006 (0.36 ± 0.15) |
| UQCF | .079 ± .008 (2.01 ± 0.20) | .049±.008 (1.24±0.20) | .051 (1.30) max. | .020 ± 0.01 (0.51 ± 0.25) |

TAPE & REEL: All tape and reel specifications are in compliance with EIA RS481 (equivalent to IEC 286 part 3).

- 8mm carrier
- 7" reel: UQCA = 500 or 4000 pc T&R
- UQCB = 500 or 1000 pc T&R
- UQCR = 500 or 1000 pc T&R
- UQCL = 500, 4000 or 10,000 pc T&R
- UQCS = 500 or 4000 pc T&R
- UQCF = 500 or 4000 pc T&R



For RoHS compliant products, please select correct termination style.

Also available in:
Not RoHS Compliant



ELECTRICAL SPECIFICATIONS

| | Temperature Characteristic Code A |
|---------------------------------------|--|
| Temperature Coefficient (TCC) | (A) 0 ± 30 PPM/°C |
| Capacitance Range | (A) 0.1 pF to 1000 pF |
| Operating Temperature | 0.1 pF to 1000 pF: from -55°C to +125°C |
| Quality Factor (Q) | Greater than 2,000 at 1 MHz |
| Insulation Resistance (IR) | 0.1 pF to 1000 pF 10 ⁵ Megohms min. @ 25°C at rated WVDC 10 ⁴ Megohms min. @ 125°C at rated WVDC |
| Working Voltage (WVDC) | See Capacitance Values table |
| Dielectric Withstanding Voltage (DWW) | 250% of rated WVDC for 5 secs |
| Aging Effects | None |
| Piezoelectric Effects | None |
| Capacitance Drift | \pm (0.02% or 0.02 pF), whichever is greater |

ENVIRONMENTAL CHARACTERISTICS

AVX UQ will meet and exceed the requirements of EIA-198, MIL-PRF-55681 and MIL-PRF-123

| | |
|---------------------------|---|
| Thermal Shock | Mil-STD-202, Method 107, Condition A |
| Moisture Resistance | Mil-STD-202, Method 106 |
| Low Voltage Humidity | Mil-STD-202, Method 103, condition A, with 1.5 VDC applied while subjected to an environment of 85°C with 85% relative humidity for 240 hours |
| Life Test | Mil-STD-202, Method 108, for 2000 hours at 125°C 200% WVDC |
| Shock | Mil-STD-202, Method 213, Condition J |
| Vibration | Mil-STD-202, Method 204, Condition B |
| Immersion | Mil-STD-202, Method 104, Condition B |
| Salt Spray | Mil-STD-202, Method 101, Condition B |
| Solderability | Mil-STD-202, Method 208 |
| Terminal Strength | Mil-STD-202, Method 211 |
| Temperature Cycling | Mil-STD-202, Method 102, Condition C |
| Barometric Pressure | Mil-STD-202, Method 105, Condition B |
| Resistance to Solder Heat | Mil-STD-202, Method 210, Condition C |

Microwave MLCs



UQ Series High Q Ultra Low ESR MLC

Case Size A

TABLE I: TC: A (0±30PPM/°C)

| Cap. pF | Cap. Tol. | WVDC | Cap. pF | Cap. Tol. | WVDC | Cap. pF | Cap. Tol. | WVDC | Cap. pF | Cap. Tol. | WVDC |
|---------|-----------|------|---------|-----------|------|---------|---------------|------|---------|---------------|------|
| 0.1 | B | 250 | 1.6 | B, C, D | 250 | 5.6 | B, C, D | 250 | 24 | F, G, J, K, M | 250 |
| 0.2 | B | 250 | 1.7 | B, C, D | 250 | 6.2 | B, C, D | 250 | 27 | F, G, J, K, M | 250 |
| 0.3 | B,C | 250 | 1.8 | B, C, D | 250 | 6.8 | B, C, J, K | 250 | 30 | F, G, J, K, M | 250 |
| 0.4 | B,C | 250 | 1.9 | B, C, D | 250 | 7.5 | B, C, J, K | 250 | 33 | F, G, J, K, M | 250 |
| 0.5 | B, C, D | 250 | 2.0 | B, C, D | 250 | 8.2 | B, C, J, K | 250 | 36 | F, G, J, K, M | 250 |
| 0.6 | B, C, D | 250 | 2.2 | B, C, D | 250 | 9.1 | B, C, J, K | 250 | 39 | F, G, J, K, M | 250 |
| 0.7 | B, C, D | 250 | 2.4 | B, C, D | 250 | 10 | F, G, J, K, M | 250 | 43 | F, G, J, K, M | 250 |
| 0.8 | B, C, D | 250 | 2.7 | B, C, D | 250 | 11 | F, G, J, K, M | 250 | 47 | F, G, J, K, M | 250 |
| 0.9 | B, C, D | 250 | 3.0 | B, C, D | 250 | 12 | F, G, J, K, M | 250 | 51 | F, G, J, K, M | 250 |
| 1.0 | B, C, D | 250 | 3.3 | B, C, D | 250 | 13 | F, G, J, K, M | 250 | 56 | F, G, J, K, M | 250 |
| 1.1 | B, C, D | 250 | 3.6 | B, C, D | 250 | 15 | F, G, J, K, M | 250 | 62 | F, G, J, K, M | 250 |
| 1.2 | B, C, D | 250 | 3.9 | B, C, D | 250 | 16 | F, G, J, K, M | 250 | 68 | F, G, J, K, M | 250 |
| 1.3 | B, C, D | 250 | 4.3 | B, C, D | 250 | 18 | F, G, J, K, M | 250 | 75 | F, G, J, K, M | 250 |
| 1.4 | B, C, D | 250 | 4.7 | B, C, D | 250 | 20 | F, G, J, K, M | 250 | 82 | F, G, J, K, M | 250 |
| 1.5 | B, C, D | 250 | 5.1 | B, C, D | 250 | 22 | F, G, J, K, M | 250 | 91 | F, G, J, K, M | 250 |
| | | | | | | | | | 100 | F, G, J, K, M | 250 |

Case Size B

TABLE II: TC: A (0±30PPM/°C)

| Cap. pF | Cap. Tol. | WVDC | Cap. pF | Cap. Tol. | WVDC | Cap. pF | Cap. Tol. | WVDC | Cap. pF | Cap. Tol. | WVDC |
|---------|-----------|------|---------|---------------|------|---------|---------------|------|---------|---------------|------|
| 0.1 | B | 500 | 3.6 | B, C, D | 500 | 39 | F, G, J, K, M | 500 | 430 | F, G, J, K, M | 200 |
| 0.2 | B | 500 | 3.9 | B, C, D | 500 | 43 | F, G, J, K, M | 500 | 470 | F, G, J, K, M | 200 |
| 0.3 | B,C | 500 | 4.3 | B, C, D | 500 | 47 | F, G, J, K, M | 500 | 510 | F, G, J, K, M | 100 |
| 0.4 | B,C | 500 | 4.7 | B, C, D | 500 | 51 | F, G, J, K, M | 500 | 560 | F, G, J, K, M | 100 |
| 0.5 | B, C, D | 500 | 5.1 | B, C, D | 500 | 56 | F, G, J, K, M | 500 | 620 | F, G, J, K, M | 100 |
| 0.6 | B, C, D | 500 | 5.6 | B, C, D | 500 | 62 | F, G, J, K, M | 500 | 680 | F, G, J, K, M | 50 |
| 0.7 | B, C, D | 500 | 6.2 | B, C, D | 500 | 68 | F, G, J, K, M | 500 | 750 | F, G, J, K, M | 50 |
| 0.8 | B, C, D | 500 | 6.8 | B, C, J, K | 500 | 75 | F, G, J, K, M | 500 | 820 | F, G, J, K, M | 50 |
| 0.9 | B, C, D | 500 | 7.5 | B, C, J, K | 500 | 82 | F, G, J, K, M | 500 | 910 | F, G, J, K, M | 50 |
| 1.0 | B, C, D | 500 | 8.2 | B, C, J, K | 500 | 91 | F, G, J, K, M | 500 | 1000 | F, G, J, K, M | 50 |
| 1.1 | B, C, D | 500 | 9.1 | B, C, J, K | 500 | 100 | F, G, J, K, M | 500 | | | |
| 1.2 | B, C, D | 500 | 10 | F, G, J, K, M | 500 | 110 | F, G, J, K, M | 300 | | | |
| 1.3 | B, C, D | 500 | 11 | F, G, J, K, M | 500 | 120 | F, G, J, K, M | 300 | | | |
| 1.4 | B, C, D | 500 | 12 | F, G, J, K, M | 500 | 130 | F, G, J, K, M | 300 | | | |
| 1.5 | B, C, D | 500 | 13 | F, G, J, K, M | 500 | 150 | F, G, J, K, M | 300 | | | |
| 1.6 | B, C, D | 500 | 15 | F, G, J, K, M | 500 | 160 | F, G, J, K, M | 300 | | | |
| 1.7 | B, C, D | 500 | 16 | F, G, J, K, M | 500 | 180 | F, G, J, K, M | 300 | | | |
| 1.8 | B, C, D | 500 | 18 | F, G, J, K, M | 500 | 200 | F, G, J, K, M | 300 | | | |
| 1.9 | B, C, D | 500 | 20 | F, G, J, K, M | 500 | 220 | F, G, J, K, M | 200 | | | |
| 2.0 | B, C, D | 500 | 22 | F, G, J, K, M | 500 | 240 | F, G, J, K, M | 200 | | | |
| 2.2 | B, C, D | 500 | 24 | F, G, J, K, M | 500 | 270 | F, G, J, K, M | 200 | | | |
| 2.4 | B, C, D | 500 | 27 | F, G, J, K, M | 500 | 300 | F, G, J, K, M | 200 | | | |
| 2.7 | B, C, D | 500 | 30 | F, G, J, K, M | 500 | 330 | F, G, J, K, M | 200 | | | |
| 3.0 | B, C, D | 500 | 33 | F, G, J, K, M | 500 | 360 | F, G, J, K, M | 200 | | | |
| 3.3 | B, C, D | 500 | 36 | F, G, J, K, M | 500 | 390 | F, G, J, K, M | 200 | | | |

Case Size R

TABLE III: TC: A (0±30PPM/°C)

| Cap. pF | Cap. Tol. | WVDC | Cap. pF | Cap. Tol. | WVDC | Cap. pF | Cap. Tol. | WVDC | Cap. pF | Cap. Tol. | WVDC |
|---------|-----------|------|---------|------------|------|---------|------------|------|---------|------------|------|
| 1.0 | B, C, D | 500 | 3.0 | B, C, D | 500 | 12 | G, J, K, M | 500 | 51 | G, J, K, M | 500 |
| 1.1 | B, C, D | 500 | 3.3 | B, C, D | 500 | 13 | G, J, K, M | 500 | 56 | G, J, K, M | 500 |
| 1.2 | B, C, D | 500 | 3.6 | B, C, D | 500 | 15 | G, J, K, M | 500 | 62 | G, J, K, M | 500 |
| 1.3 | B, C, D | 500 | 3.9 | B, C, D | 500 | 16 | G, J, K, M | 500 | 68 | G, J, K, M | 500 |
| 1.4 | B, C, D | 500 | 4.3 | B, C, D | 500 | 18 | G, J, K, M | 500 | 75 | G, J, K, M | 500 |
| 1.5 | B, C, D | 500 | 4.7 | B, C, D | 500 | 20 | G, J, K, M | 500 | 82 | G, J, K, M | 500 |
| 1.6 | B, C, D | 500 | 5.1 | B, C, D | 500 | 22 | G, J, K, M | 500 | 91 | G, J, K, M | 500 |
| 1.7 | B, C, D | 500 | 5.6 | G, J, K, M | 500 | 24 | G, J, K, M | 500 | 100 | G, J, K, M | 500 |
| 1.8 | B, C, D | 500 | 6.2 | G, J, K, M | 500 | 27 | G, J, K, M | 500 | | | |
| 1.9 | B, C, D | 500 | 6.8 | G, J, K, M | 500 | 30 | G, J, K, M | 500 | | | |
| 2.0 | B, C, D | 500 | 7.5 | G, J, K, M | 500 | 33 | G, J, K, M | 500 | | | |
| 2.1 | B, C, D | 500 | 8.2 | G, J, K, M | 500 | 36 | G, J, K, M | 500 | | | |
| 2.2 | B, C, D | 500 | 9.1 | G, J, K, M | 500 | 39 | G, J, K, M | 500 | | | |
| 2.4 | B, C, D | 500 | 10 | G, J, K, M | 500 | 43 | G, J, K, M | 500 | | | |
| 2.7 | B, C, D | 500 | 11 | G, J, K, M | 500 | 47 | G, J, K, M | 500 | | | |



Case Size L

TABLE IV: TC: A (0±30PPM/°C)

| Cap. pF | Cap. Tol. | WVDC | Cap. pF | Cap. Tol. | WVDC | Cap. pF | Cap. Tol. | WVDC |
|---------|------------|------|---------|------------|------|---------|---------------|------|
| 0.1 | A, B | 200 | 1.6 | A, B, C, D | 200 | 6.2 | A, B, C, D | 200 |
| 0.2 | A, B | 200 | 1.8 | A, B, C, D | 200 | 6.8 | B, C, J, K | 200 |
| 0.3 | A, B, C | 200 | 2.0 | A, B, C, D | 200 | 7.5 | B, C, J, K | 200 |
| 0.4 | A, B, C | 200 | 2.2 | A, B, C, D | 200 | 8.2 | B, C, J, K | 200 |
| 0.5 | A, B, C | 200 | 2.4 | A, B, C, D | 200 | 9.1 | B, C, J, K | 200 |
| 0.6 | A, B, C | 200 | 2.7 | A, B, C, D | 200 | 10 | F, G, J, K, M | 200 |
| 0.7 | A, B, C | 200 | 3.0 | A, B, C, D | 200 | 11 | F, G, J, K, M | 200 |
| 0.8 | A, B, C | 200 | 3.3 | A, B, C, D | 200 | 12 | F, G, J, K, M | 200 |
| 0.9 | A, B, C | 200 | 3.6 | A, B, C, D | 200 | 15 | F, G, J, K, M | 200 |
| 1.0 | A, B, C, D | 200 | 3.9 | A, B, C, D | 200 | 18 | F, G, J, K, M | 200 |
| 1.1 | A, B, C, D | 200 | 4.3 | A, B, C, D | 200 | 20 | F, G, J, K, M | 200 |
| 1.2 | A, B, C, D | 200 | 4.7 | A, B, C, D | 200 | 22 | F, G, J, K, M | 200 |
| 1.3 | A, B, C, D | 200 | 5.1 | A, B, C, D | 200 | 24 | F, G, J, K, M | 200 |
| 1.5 | A, B, C, D | 200 | 5.6 | A, B, C, D | 200 | 27 | F, G, J, K, M | 200 |

Case Size S

TABLE V:

| Cap. pF | Cap. Tol. | WVDC | Cap. pF | Cap. Tol. | WVDC | Cap. pF | Cap. Tol. | WVDC |
|---------|------------|------|---------|---------------|------|---------|---------------|------|
| 0.1 | A, B | 250 | 2.7 | A, B, C, D | 250 | 20 | F, G, J, K, M | 250 |
| 0.2 | A, B | 250 | 3.0 | A, B, C, D | 250 | 22 | F, G, J, K, M | 250 |
| 0.3 | A, B, C | 250 | 3.3 | A, B, C, D | 250 | 24 | F, G, J, K, M | 250 |
| 0.4 | A, B, C | 250 | 3.6 | A, B, C, D | 250 | 27 | F, G, J, K, M | 250 |
| 0.5 | A, B, C | 250 | 3.9 | A, B, C, D | 250 | 30 | F, G, J, K, M | 250 |
| 0.6 | A, B, C | 250 | 4.3 | A, B, C, D | 250 | 33 | F, G, J, K, M | 250 |
| 0.7 | A, B, C | 250 | 4.7 | A, B, C, D | 250 | 36 | F, G, J, K, M | 250 |
| 0.8 | A, B, C | 250 | 5.1 | A, B, C, D | 250 | 39 | F, G, J, K, M | 250 |
| 0.9 | A, B, C | 250 | 5.6 | A, B, C, D | 250 | 43 | F, G, J, K, M | 250 |
| 1.0 | A, B, C, D | 250 | 6.2 | A, B, C, D | 250 | 47 | F, G, J, K, M | 250 |
| 1.1 | A, B, C, D | 250 | 6.8 | B, C, J, K | 250 | 51 | F, G, J, K, M | 250 |
| 1.2 | A, B, C, D | 250 | 7.5 | B, C, J, K | 250 | 56 | F, G, J, K, M | 250 |
| 1.3 | A, B, C, D | 250 | 8.2 | B, C, J, K | 250 | 62 | F, G, J, K, M | 250 |
| 1.5 | A, B, C, D | 250 | 9.1 | B, C, J, K | 250 | 68 | F, G, J, K, M | 250 |
| 1.6 | A, B, C, D | 250 | 10 | F, G, J, K, M | 250 | 75 | F, G, J, K, M | 250 |
| 1.8 | A, B, C, D | 250 | 11 | F, G, J, K, M | 250 | 82 | F, G, J, K, M | 250 |
| 2.0 | A, B, C, D | 250 | 12 | F, G, J, K, M | 250 | 91 | F, G, J, K, M | 250 |
| 2.2 | A, B, C, D | 250 | 15 | F, G, J, K, M | 250 | 100 | F, G, J, K, M | 250 |
| 2.4 | A, B, C, D | 250 | 18 | F, G, J, K, M | 250 | | | |

Case Size F

TABLE VI:

| Cap. pF | Cap. Tol. | WVDC | Cap. pF | Cap. Tol. | WVDC | Cap. pF | Cap. Tol. | WVDC |
|---------|------------|------|---------|---------------|------|---------|---------------|------|
| 0.1 | A, B | 250 | 3.3 | A, B, C, D | 250 | 30 | F, G, J, K, M | 250 |
| 0.2 | A, B | 250 | 3.6 | A, B, C, D | 250 | 33 | F, G, J, K, M | 250 |
| 0.3 | A, B, C | 250 | 3.9 | A, B, C, D | 250 | 36 | F, G, J, K, M | 250 |
| 0.4 | A, B, C | 250 | 4.3 | A, B, C, D | 250 | 39 | F, G, J, K, M | 250 |
| 0.5 | A, B, C | 250 | 4.7 | A, B, C, D | 250 | 43 | F, G, J, K, M | 250 |
| 0.6 | A, B, C | 250 | 5.1 | A, B, C, D | 250 | 47 | F, G, J, K, M | 250 |
| 0.7 | A, B, C | 250 | 5.6 | A, B, C, D | 250 | 51 | F, G, J, K, M | 250 |
| 0.8 | A, B, C | 250 | 6.2 | A, B, C, D | 250 | 56 | F, G, J, K, M | 250 |
| 0.9 | A, B, C | 250 | 6.8 | B, C, J, K | 250 | 62 | F, G, J, K, M | 250 |
| 1.0 | A, B, C, D | 250 | 7.5 | B, C, J, K | 250 | 68 | F, G, J, K, M | 250 |
| 1.1 | A, B, C, D | 250 | 8.2 | B, C, J, K | 250 | 75 | F, G, J, K, M | 250 |
| 1.2 | A, B, C, D | 250 | 9.1 | B, C, J, K | 250 | 82 | F, G, J, K, M | 250 |
| 1.3 | A, B, C, D | 250 | 10 | F, G, J, K, M | 250 | 91 | F, G, J, K, M | 250 |
| 1.5 | A, B, C, D | 250 | 11 | F, G, J, K, M | 250 | 100 | F, G, J, K, M | 250 |
| 1.6 | A, B, C, D | 250 | 12 | F, G, J, K, M | 250 | 110 | F, G, J, K, M | 250 |
| 1.8 | A, B, C, D | 250 | 15 | F, G, J, K, M | 250 | 120 | F, G, J, K, M | 250 |
| 2.0 | A, B, C, D | 250 | 18 | F, G, J, K, M | 250 | 150 | F, G, J, K, M | 250 |
| 2.2 | A, B, C, D | 250 | 20 | F, G, J, K, M | 250 | 180 | F, G, J, K, M | 250 |
| 2.4 | A, B, C, D | 250 | 22 | F, G, J, K, M | 250 | 200 | F, G, J, K, M | 250 |
| 2.7 | A, B, C, D | 250 | 24 | F, G, J, K, M | 250 | 220 | F, G, J, K, M | 250 |
| 3.0 | A, B, C, D | 250 | 27 | F, G, J, K, M | 250 | 240 | F, G, J, K, M | 250 |

UQ CA ESR vs. Frequency

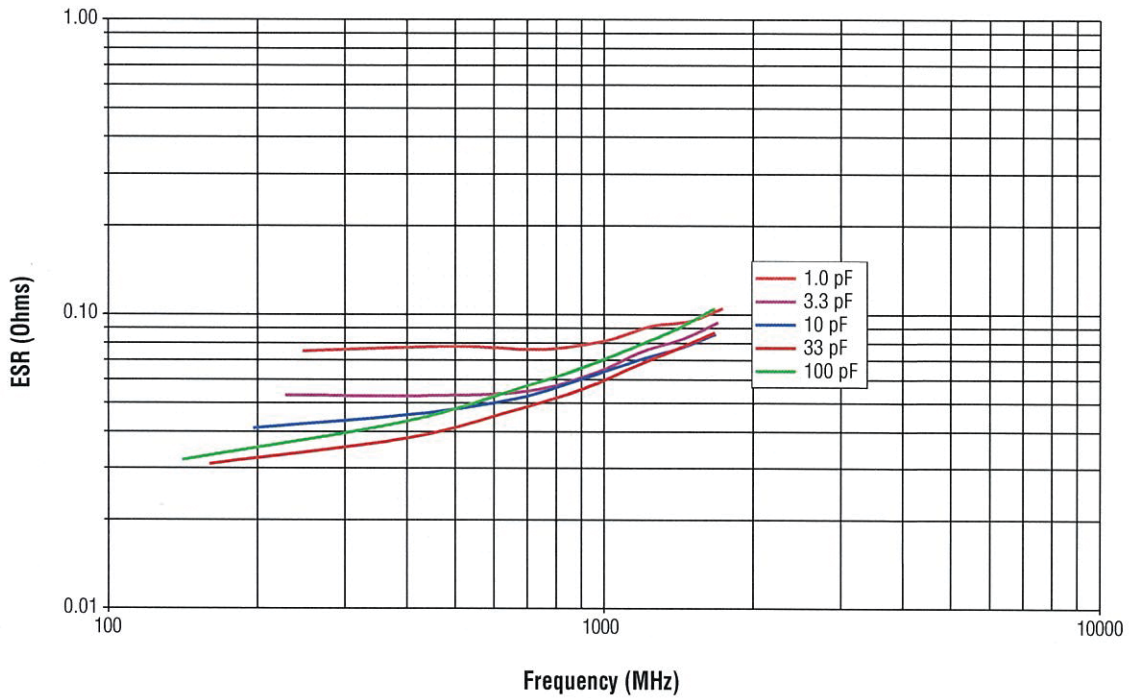

UQ CA FSR & FPR vs. Capacitance

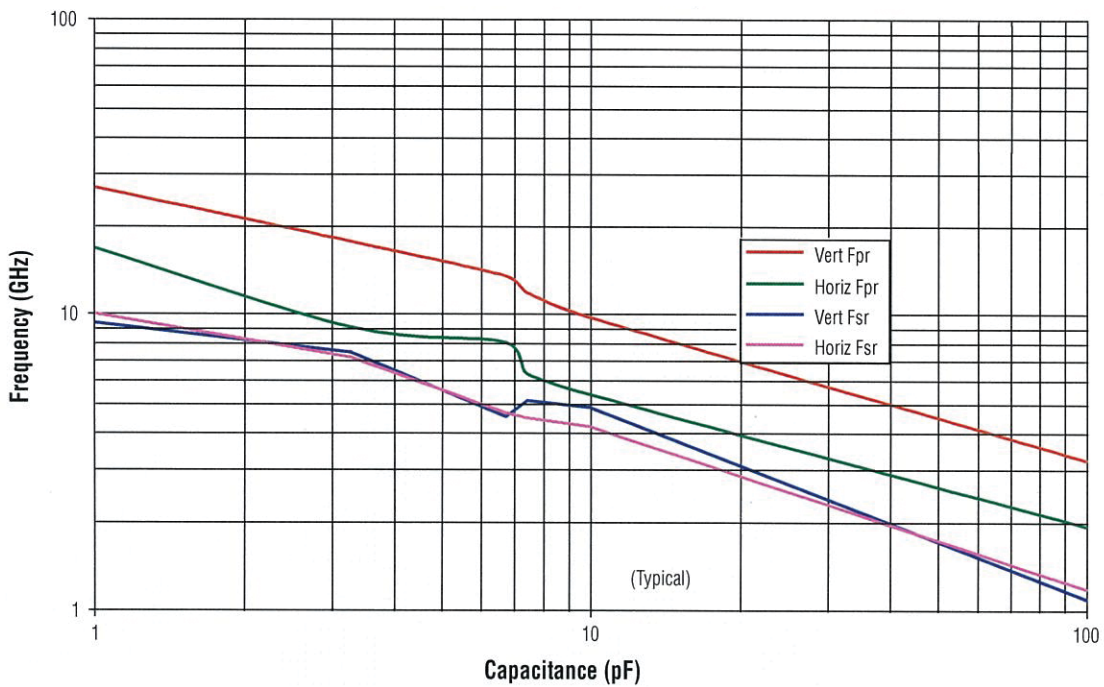

UQ CB ESR vs. Frequency

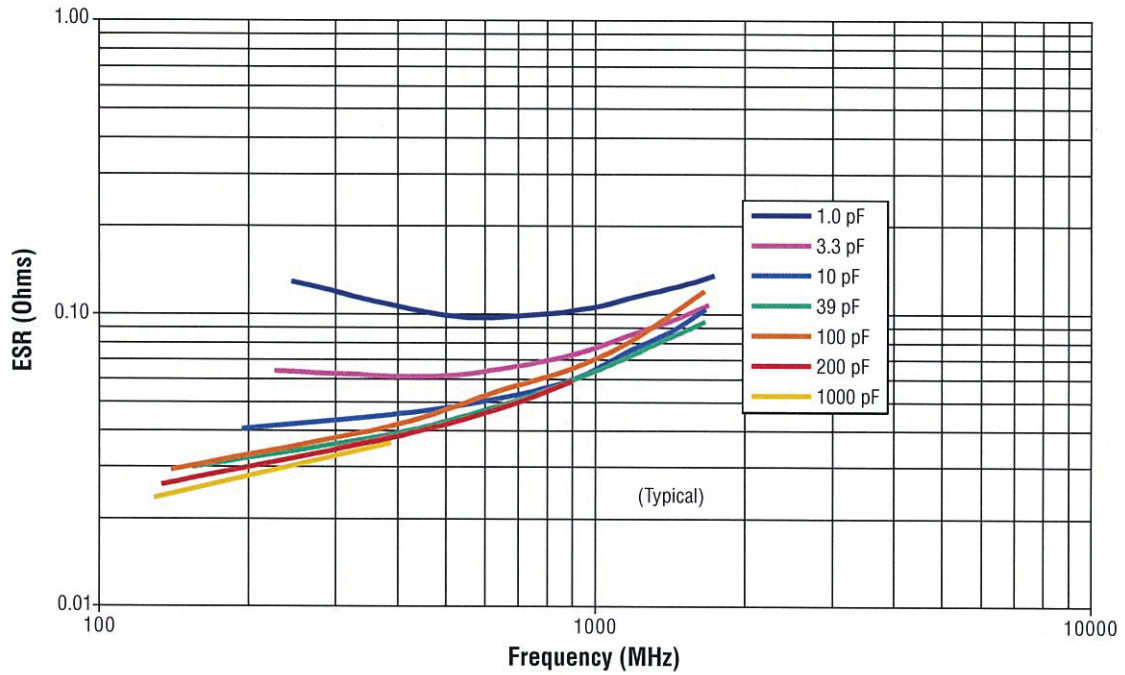

UQ CB FSR & FPR vs. Capacitance

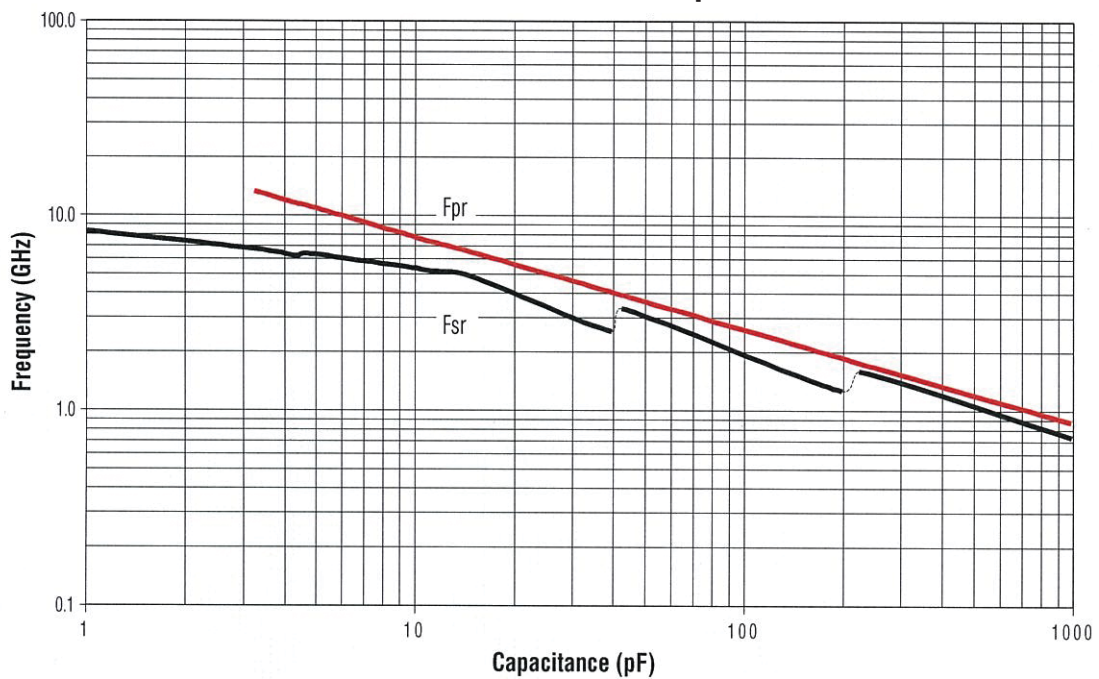

UQ CR ESR vs. Frequency

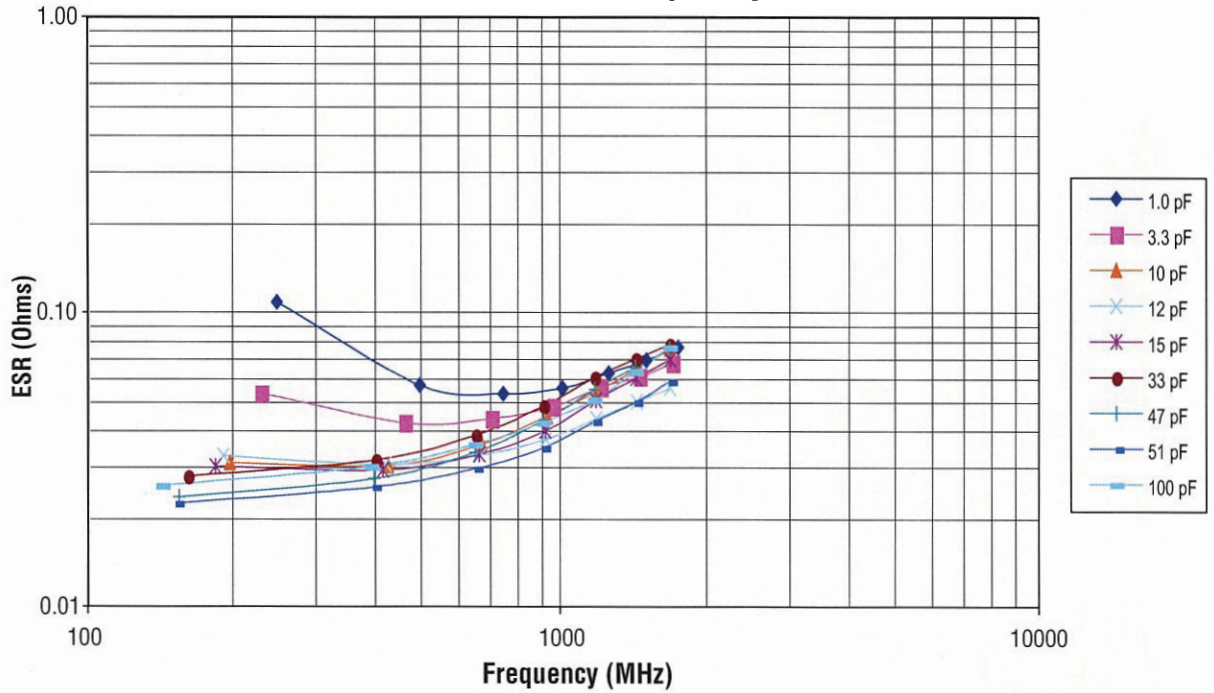

UQ CR Resonance Horizontal Orientation

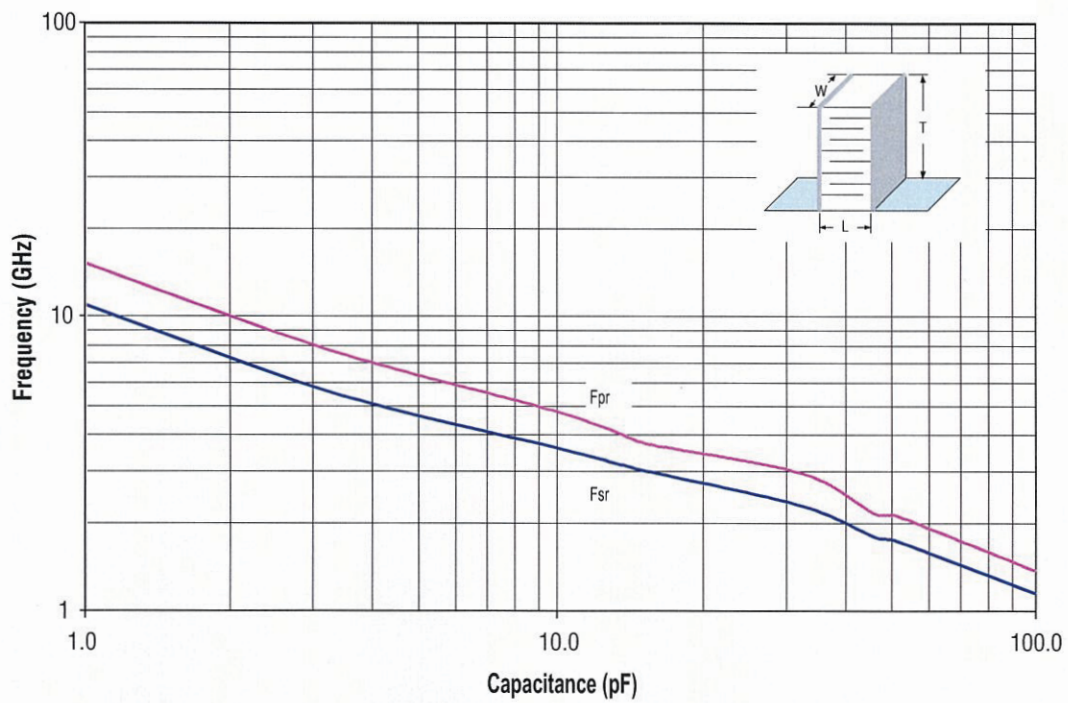

UQ CL ESR vs. Frequency

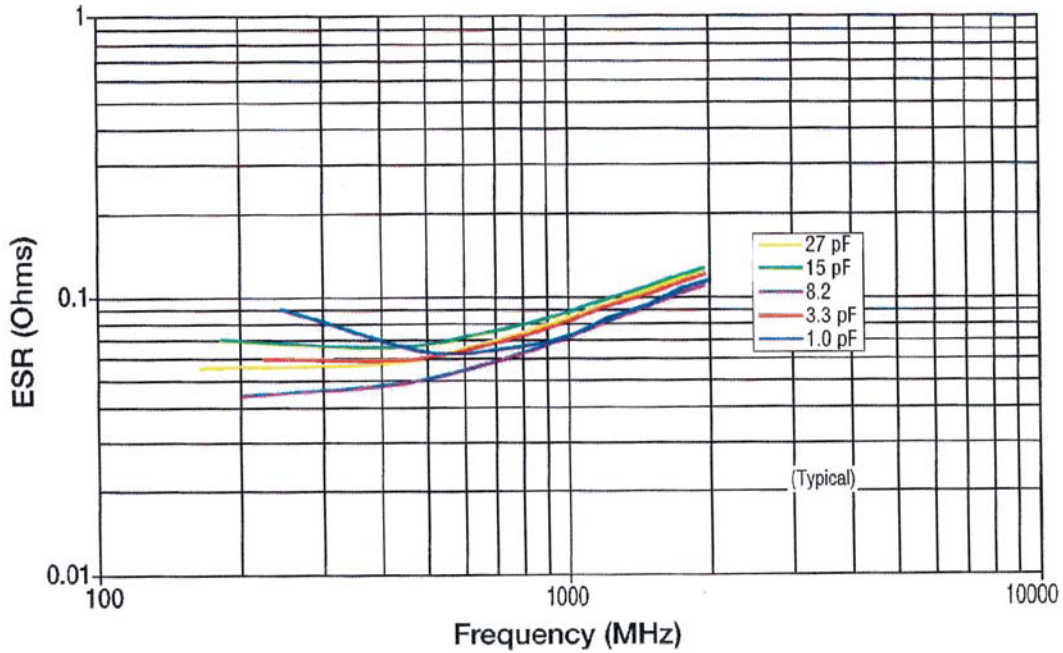

UQ CL Resonance Frequency

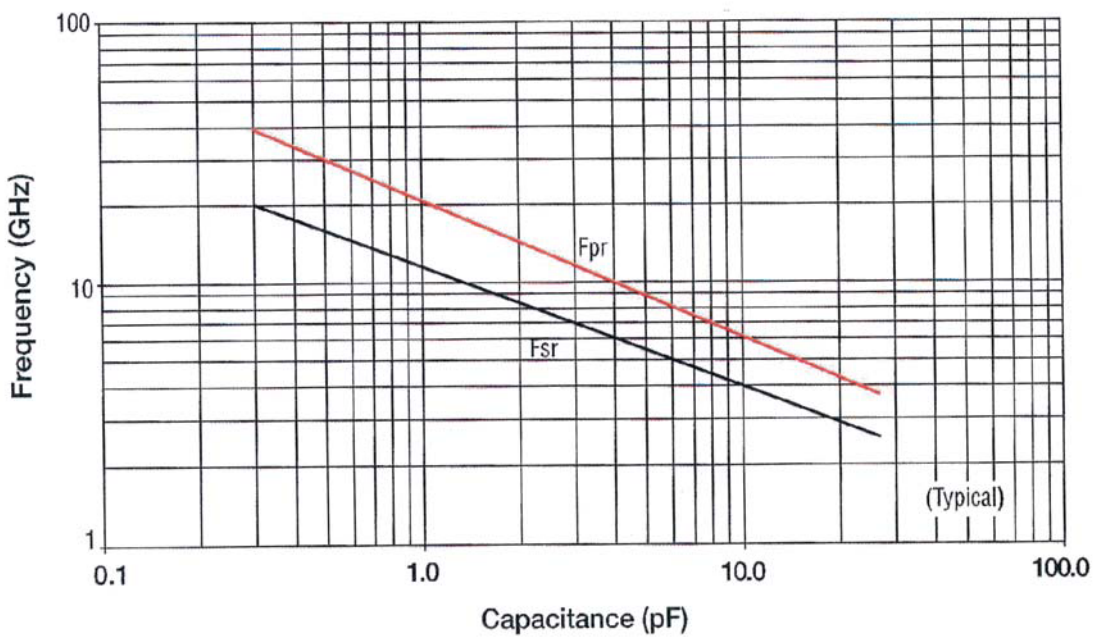

UQ CS ESR vs. Frequency

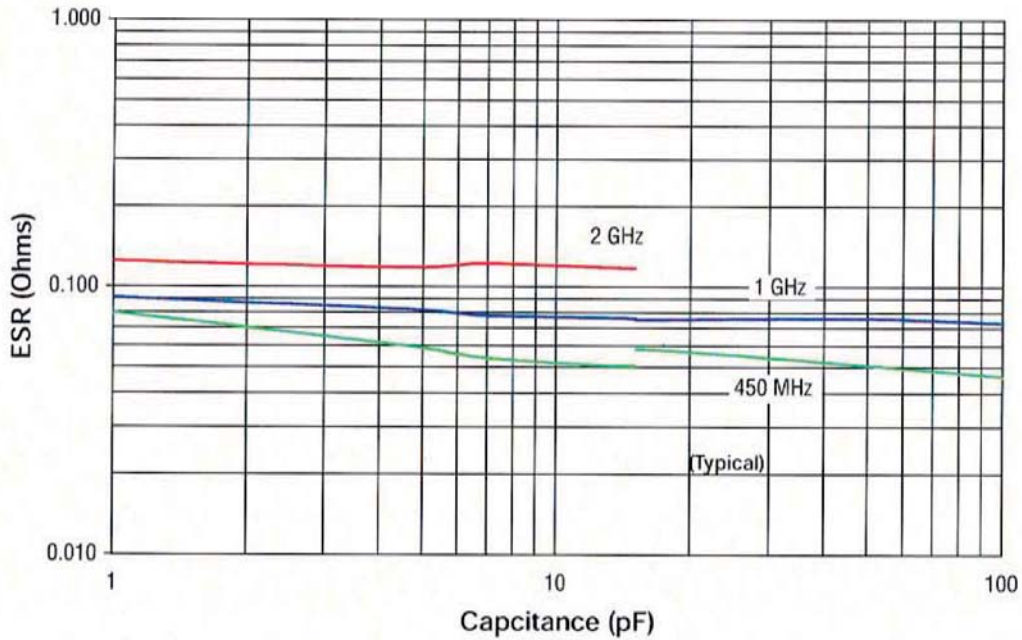

UQ CS ESR vs. Frequency

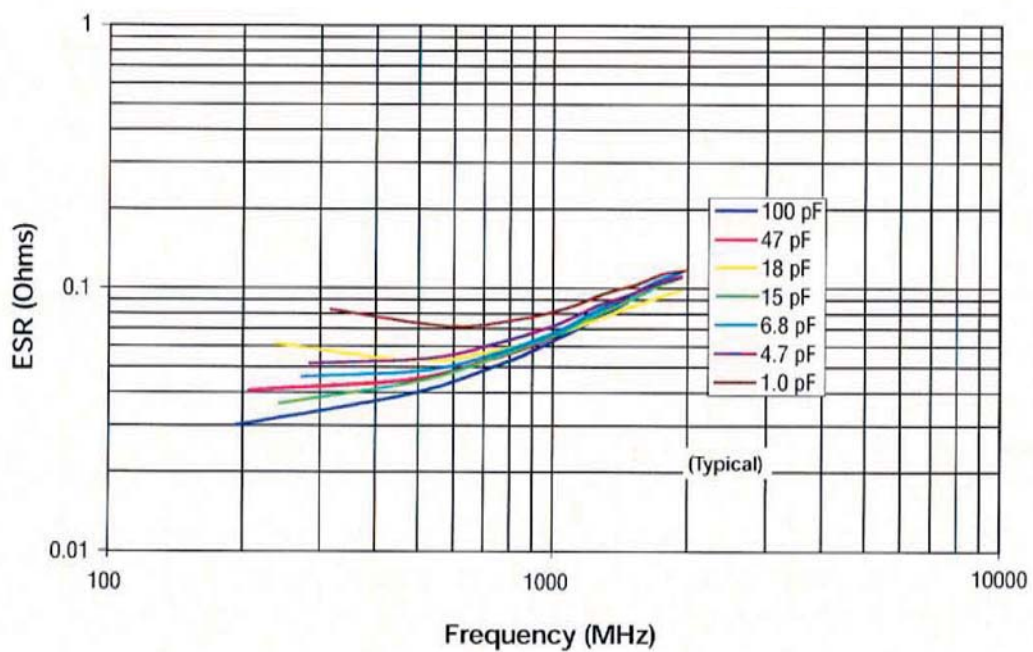

UQ CS Q vs. Capacitance

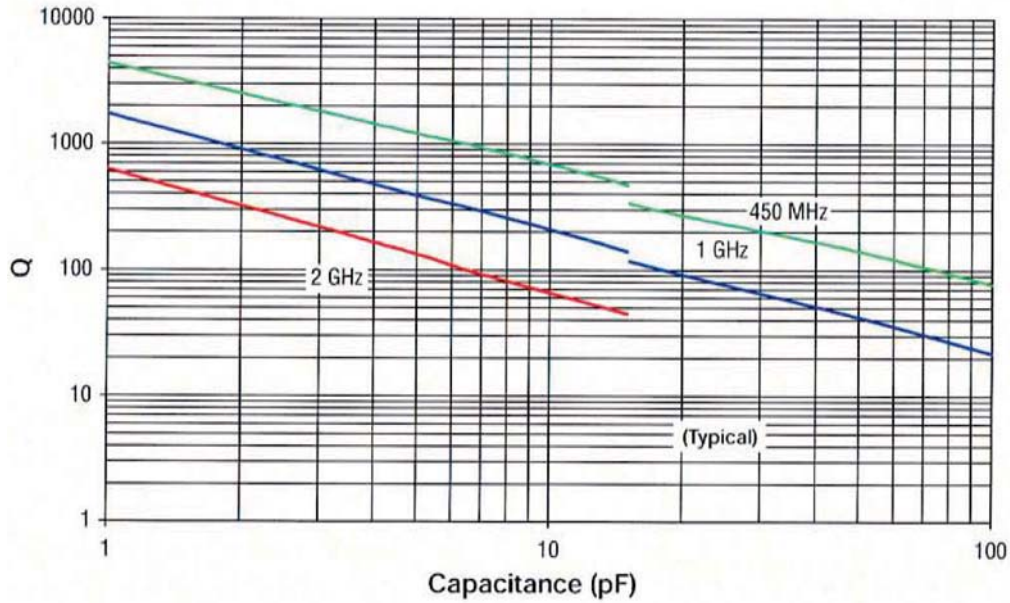

UQ CS Resonant Frequency

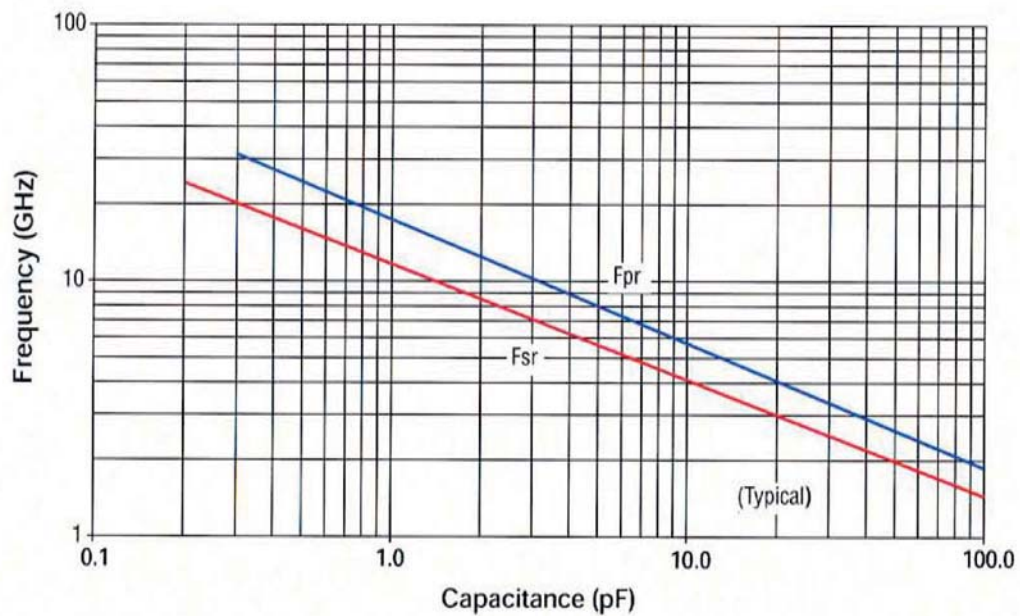

UQ CF ESR vs. Frequency

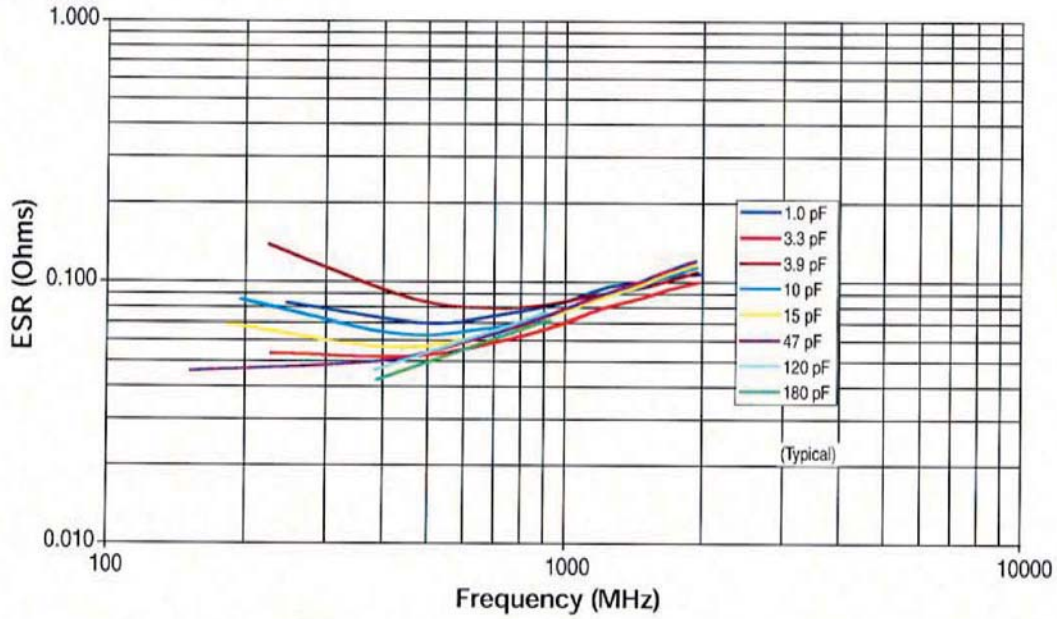

UQ CF Resonant Frequency

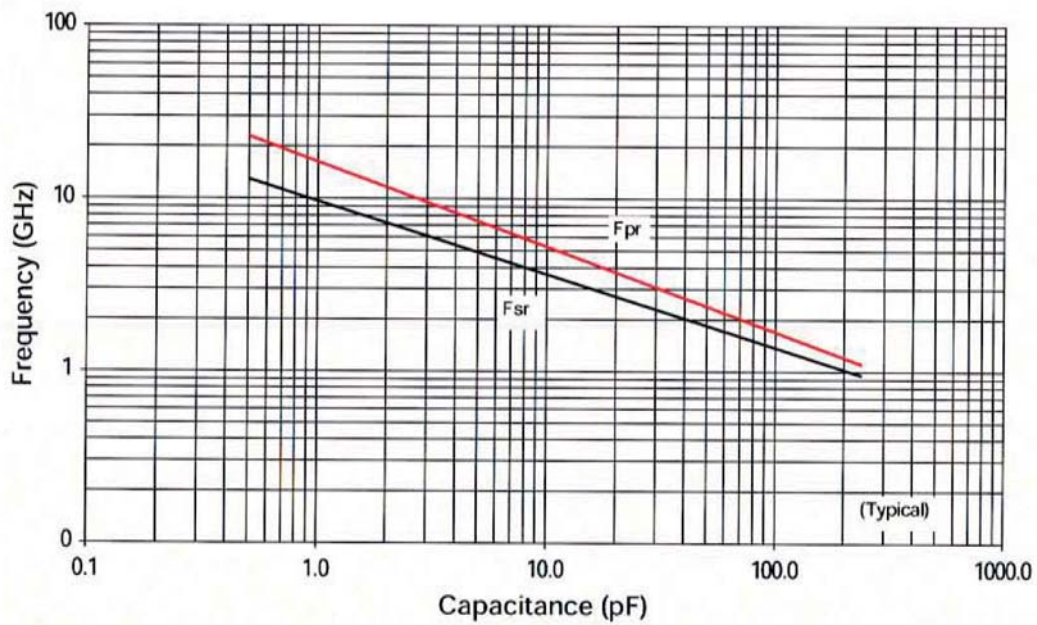

Microwave MLCs



UQ Series High Q Ultra Low ESR MLC

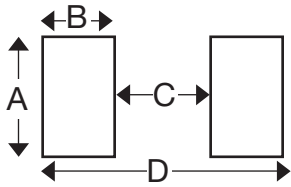

MOUNTING PAD DIMENSIONS CASE CA: inches (millimeters)

| | Pad Size | A min | B min | C min | D min |
|------------------|--------------|---------------|---------------|---------------|---------------|
| Vertical Mount | Normal | 0.070 (1.778) | 0.050 (1.270) | 0.030 (0.762) | 0.130 (3.302) |
| | High Density | 0.050 (1.270) | 0.030 (0.762) | 0.030 (0.762) | 0.090 (2.286) |
| Horizontal Mount | Normal | 0.080 (2.032) | 0.050 (1.270) | 0.030 (0.762) | 0.130 (3.302) |
| | High Density | 0.060 (1.524) | 0.030 (0.762) | 0.030 (0.762) | 0.090 (2.286) |

MOUNTING PAD DIMENSIONS CASE CB: inches (millimeters)

| | Cap Value | Pad Size | A min | B min | C min | D min |
|------------------|---------------|--------------|---------------|---------------|---------------|---------------|
| Vertical Mount | 0.1 pF | Normal | 0.065 (1.651) | 0.050 (1.270) | 0.075 (1.905) | 0.175 (4.445) |
| | | High Density | 0.045 (1.143) | 0.030 (0.762) | 0.075 (1.905) | 0.135 (3.429) |
| | 0.2 pF | Normal | 0.090 (2.286) | 0.050 (1.270) | 0.075 (1.905) | 0.175 (4.445) |
| | | High Density | 0.070 (1.778) | 0.030 (0.762) | 0.075 (1.905) | 0.135 (3.429) |
| | 0.3 to 510 pF | Normal | 0.110 (2.794) | 0.050 (1.270) | 0.075 (1.905) | 0.175 (4.445) |
| | | High Density | 0.090 (2.286) | 0.030 (0.762) | 0.075 (1.905) | 0.135 (3.429) |
| Horizontal Mount | > 510 pF | Normal | 0.120 (3.048) | 0.050 (1.270) | 0.075 (1.905) | 0.175 (4.445) |
| | | High Density | 0.100 (2.540) | 0.030 (0.762) | 0.075 (1.905) | 0.135 (3.429) |
| | All Values | Normal | 0.130 (3.302) | 0.050 (1.270) | 0.075 (1.905) | 0.175 (4.445) |
| | | High Density | 0.110 (2.794) | 0.030 (0.762) | 0.075 (1.905) | 0.135 (3.429) |

MOUNTING PAD DIMENSIONS CASE CL, CS & CF: inches (millimeters)

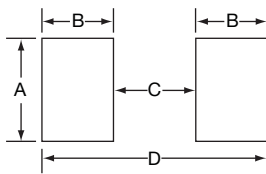
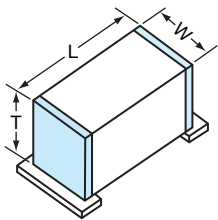

| Case | A min. | B min. | C min. | D min. |
|-------------|-----------------|-----------------|------------------|-----------------|
| 0402 (1005) | .0275 (0.70) | .0354 (0.90) | .0157 (0.40) | .0866 (2.20) |
| 0603 (1608) | .0393 (1.00) | .0433 (1.10) | .03236 (0.60) | .110 (2.80) |
| 0805 (2012) | .0590 (1.50) | .0512 (1.30) | .0236 (0.60) | .1259 (3.20) |

Microwave MLCs



UQ Series High Q Ultra Low ESR MLC

DESIGN KITS

| Kit # | Compliance | Description | Cap Value | Cap. Values (pF) | Tol. (pF) |
|------------|------------|--|----------------|---|-----------|
| KITUQ800LF | | UQCA 0605 Series Ultra-Low ESR High Q Microwave Capacitors 16 different values, 15 pcs min. per value | 0.1 to 2.0 | 0.1, 0.2, 0.3, 0.4, 0.5, 0.6, 0.7, 0.8, 0.9, 1.0, 1.1, 1.2, 1.5 | ±0.1 |
| | | | | 1.6, 1.8, 2.0 | ±0.25 |
| KITUQ810LF | | UQCA 0605 Series Ultra-Low ESR High Q Microwave Capacitors 16 different values, 15 pcs min. per value | 1.0 to 10 pF | 1.0, 1.2, 1.5, 1.8, 2.0, 2.2, 2.4, 2.7, 3.0, 3.3 | ±0.1 |
| | | | | 3.9, 4.7, 5.6, 6.8, 8.0 | ±0.25 |
| | | | | 10 | ±5% |
| KITUQ820LF | | UQCA 0605 Series Ultra-Low ESR High Q Microwave Capacitors 16 different values, 15 pcs min. per value | 10 to 100 pF | 10, 12, 15, 18, 20, 22, 24, 27, 30, 33, 39, 47, 56, 68, 82, 100 | ±5% |
| KITUQ830LF | | UQCB 1210 Series Ultra-Low ESR High Q Microwave Capacitors 16 different values, 15 pcs min. per value | 1.0 to 10 pF | 1.0, 1.2, 1.5, 1.8, 2.0, 2.2, 2.4, 2.7, 3.0, 3.3 | ±0.1 |
| | | | | 3.9, 4.7, 5.6, 6.8, 8.0 | ±0.25 |
| | | | | 10 | ±5% |
| KITUQ840LF | | UQCB 1210 Series Ultra-Low ESR High Q Microwave Capacitors 16 different values, 15 pcs min. per value | 10 to 100 pF | 10, 12, 15, 18, 20, 22, 24, 27, 30, 33, 39, 47, 56, 68, 82, 100 | ±5% |
| KITUQ850LF | | UQCB 1210 Series Ultra-Low ESR High Q Microwave Capacitors 16 different values, 15 pcs min. per value | 100 to 1000 pF | 100, 120, 150, 180, 200, 220, 240, 270, 300, 330, 390, 470 | ±5% |
| | | | | 560, 680, 820, 1000 | ±10% |
| KITUQ360LF | | UQCL 0402 Series Ultra-Low ESR High Q Microwave Capacitors 16 different values, 15 pcs min. per value | 0.1 to 2.0 | 0.1, 0.2, 0.3, 0.4, 0.5, 0.6, 0.7, 0.8, 0.9, 1.0, 1.1, 1.2, 1.5 | ±0.1 |
| | | | | 1.6, 1.8, 2.0 | ±0.25 |
| KITUQ370LF | | UQCL 0402 Series Ultra-Low ESR High Q Microwave Capacitors 16 different values, 15 pcs min. per value | 1.0 to 10 | 1.0, 1.2, 1.5, 1.8, 2.0, 2.2, 2.4, 2.7, 3.0, 3.3 | ±0.1 |
| | | | | 3.9, 4.7, 5.6, 6.8, 8.2 | ±0.25 |
| | | | | 10 | ±5% |
| KITUQ380LF | | UQCL 0402 Series Ultra-Low ESR High Q Microwave Capacitors 8 different values, 15 pcs min. per value | 10 to 27 | 10, 12, 15, 18, 20, 22, 24, 27 | ±5% |
| KITUQ250LF | | UQCS 0603 Series Ultra-Low ESR High Q Microwave Capacitors 16 different values, 15 pcs min. per value | 0.1 to 2.0 | 0.1, 0.2, 0.3, 0.4, 0.5, 0.6, 0.7, 0.8, 0.9, 1.0, 1.1, 1.2, 1.5 | ±0.1 |
| | | | | 1.6, 1.8, 2.0 | ±0.25 |
| KITUQ260LF | | UQCS 0603 Series Ultra-Low ESR High Q Microwave Capacitors 16 different values, 15 pcs min. per value | 1.0 to 10 | 1.0, 1.2, 1.5, 1.8, 2.0, 2.2, 2.4, 2.7, 3.0, 3.3 | ±0.1 |
| | | | | 3.9, 4.7, 5.6, 6.8, 8.2 | ±0.25 |
| | | | | 10 | ±5% |
| KITUQ270LF | | UQCS 0603 Series Ultra-Low ESR High Q Microwave Capacitors 16 different values, 15 pcs min. per value | 10 to 100 | 10, 12, 15, 18, 20, 22, 24, 27, 30, 33, 39, 47, 56, 68, 82, 100 | ±5% |
| KITUQ320LF | | UQCF 0805 Series Ultra-Low ESR High Q Microwave Capacitors 16 different values, 15 pcs min. per value | 0.1 to 2.0 | 0.1, 0.2, 0.3, 0.4, 0.5, 0.6, 0.7, 0.8, 0.9, 1.0, 1.1, 1.2, 1.5 | ±0.1 |
| | | | | 1.6, 1.8, 2.0 | ±0.25 |
| KITUQ330LF | | UQCF 0805 Series Ultra-Low ESR High Q Microwave Capacitors 16 different values, 15 pcs min. per value | 1.0 to 10 | 1.0, 1.2, 1.5, 1.8, 2.0, 2.2, 2.4, 2.7, 3.0, 3.3 | ±0.1 |
| | | | | 3.9, 4.7, 5.6, 6.8, 8.2 | ±0.25 |
| | | | | 10 | ±5% |
| KITUQ340LF | | UQCF 0805 Series Ultra-Low ESR High Q Microwave Capacitors 16 different values, 15 pcs min. per value | 10 to 100 | 10, 12, 15, 18, 20, 22, 24, 27, 30, 33, 39, 47, 56, 68, 82, 100 | ±5% |
| KITUQ350LF | | UQCF 0805 Series Ultra-Low ESR High Q Microwave Capacitors 7 different values, 15 pcs min. per value | 100 to 240 | 100, 120, 150, 180, 200, 220, 250 | ±5% |

Microwave MLC's

SQ Series Ultra Low ESR MLC

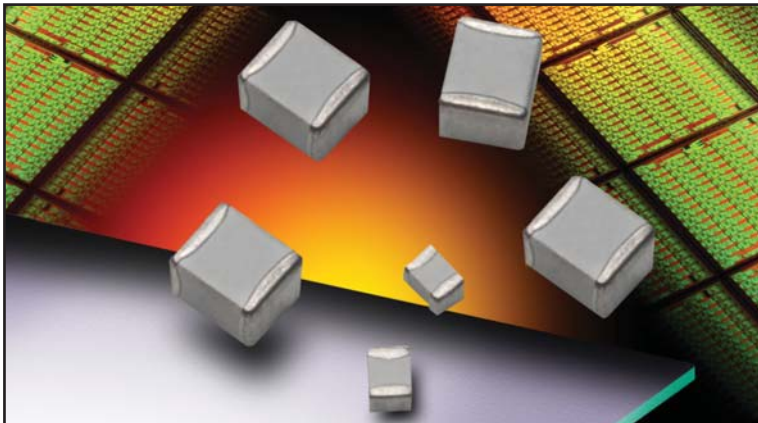

FEATURES:

- Low ESR
- High Q
- High Self Resonance
- Capacitance Range 0.1 pF to 5100 pF
- 175°C Capability SQCB

APPLICATIONS:

- RF Power Amplifiers
- Low Noise Amplifiers
- Filter Networks
- MRI Systems

HOW TO ORDER

| | | | | | | | | |
|-----------------------------------|---|---|--|---|--|---|---|--|
| <p>SQ</p> <p>AVX Style</p> | <p>CA</p> <p>Case Size CA = 0605 CB = 1210</p> <p>See mechanical dimensions below</p> | <p>7</p> <p>Voltage Code</p> <p>5 = 50V 1 = 100V E = 150V 2 = 200V V = 250V 9 = 300V 7 = 500V</p> | <p>M</p> <p>Temperature Coefficient Code</p> <p>M = +90±20ppm/°C A = 0±30ppm/°C C = 15% ("J" Termination only)</p> | <p>100</p> <p>Capacitance</p> <p>EIA Capacitance Code in pF. First two digits = significant figures or "R" for decimal place. Third digit = number of zeros or after "R" significant figures.</p> | <p>J</p> <p>Capacitance Tolerance Code</p> <p>B = ±.1 pF C = ±.25 pF D = ±.5 pF F = ±1% G = ±2% J = ±5% K = ±10% M = ±20% N = ±30%</p> | <p>A</p> <p>Failure Rate Code</p> <p>A = Not Applicable</p> | <p>T</p> <p>Termination Style Code</p> <p>**1 = Pd/Ag **7 = Ag/Ni/Au J = Nickel Barrier Sn/Pb (60/40) **T = 100% Tin H = Cu/Sn (Non-Magnetic)</p> | <p>1A</p> <p>Packaging Code</p> <p>1A = 7" Reel Unmarked 6A = Waffle Pack Unmarked ME = 7" Reel Marked WE = Waffle Pack Marked</p> <p>* Vertical T&R available</p> |
|-----------------------------------|---|---|--|---|--|---|---|--|

****RoHS compliant**

MECHANICAL DIMENSIONS: inches (millimeters)

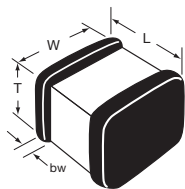

| Case | Length (L) | Width (W) | Thickness (T) | Band Width (bw) |
|-------|--|--------------------------|--------------------------|--|
| SQCA* | .055 + .015 - .010 (1.40+ .381 - .254) | .055±.015 (1.40±.381) | .020/.057 (.508/1.45) | .010 + .010 - .005 (.254 + .254 - .127) |
| SQCB* | .110 + .020 - .010 (2.79 + .508 - .254) | .110±.010 (2.79±.254) | .030/.102 (.762/2.59) | .015±.010 (.381±.254) |

TAPE & REEL: All tape and reel specifications are in compliance with EIA RS481 (equivalent to IEC 286 part 3).

- 8mm carrier
- 7" reel: SQCA/SQCB = 1000 pcs

WAFFLE PACK

SQCA 100 pcs
SQCB 100 pcs

Not RoHS Compliant



For RoHS compliant products, please select correct termination style.

Microwave MLC's

SQ Series Ultra Low ESR MLC



ELECTRICAL SPECIFICATIONS

| | | M & A | C |
|---------------------------------------|-------------------------|---|---|
| Temperature Coefficient (TCC) | | (M) $+90 \pm 20$ PPM/°C (-55°C to +125°C) (M) $+90 \pm 30$ PPM/°C (+125°C to +175°C)* (A) 0 ± 30 PPM/°C | $\pm 15\%$ (-55°C to 125°C) |
| Capacitance Range | | (M) 0.1 pF to 1000 pF (A) 0.1 pF to 5100 pF | 0.001 μ F to 0.1 μ F |
| Operating Temperature | | 0.1 pF to 330 pF: from -55°C to +175°C* 360 pF to 5100 pF: from -55°C to +125°C | -55°C to +125°C |
| Quality Factor (Q) | M Dielectric A & B Case | Greater than 10,000 at 1 MHz | 2.5% @ 1kHz |
| | A Dielectric B Case | Greater than 10,000 at 1 MHz Greater than 2,000 at 1 MHz Greater than 2,000 at 1 KHz | 0.1 - 200 pF 220 - 1000 pF 1100 - 5100 pF |
| | A Dielectric A Case | Greater than 10,000 at 1 MHz Greater than 2,000 at 1 MHz | 0.1 - 100 pF 110 - 1000 pF |
| Insulation Resistance (IR) | | 0.2 pF to 470 pF 10 ⁹ Megohms min. @ 25°C at rated WVDC 10 ⁸ Megohms min. @ 125°C at rated WVDC 510 pF to 5100 pF 10 ⁹ Megohms min. @ 25°C at rated WVDC 10 ⁸ Megohms min. @ 125°C at rated WVDC | 10 ⁴ Megohms min. @ 25°C at rated WVDC 10 ³ Megohms min. @ 125°C at rated WVDC |
| Working Voltage (WVDC) | | See Capacitance Values table | See Capacitance Values table |
| Dielectric Withstanding Voltage (DWW) | | 250% of rated WVDC for 5 secs (for 500V rated 150% of rated voltage) | 250% of rated WVDC for 5 secs |
| Aging Effects | | None | <3% per decade hour |
| Piezoelectric Effects | | None | None |
| Capacitance Drift | | \pm (0.02% or 0.02 pF), whichever is greater | Not Applicable |

* 175 SQCB & SQLB only

ENVIRONMENTAL CHARACTERISTICS

AVX SQ will meet and exceed the requirements of EIA-198, MIL-PRF-55681 and MIL-PRF-123

| | |
|---------------------------|---|
| Thermal Shock | Mil-STD-202, Method 107, Condition A |
| Moisture Resistance | Mil-STD-202, Method 106 |
| Low Voltage Humidity | Mil-STD-202, Method 103, condition A, with 1.5 VDC applied while subjected to an environment of 85°C with 85% relative humidity for 240 hours |
| Life Test | Mil-STD-202, Method 108, for 2000 hours at 125°C |
| Shock | Mil-STD-202, Method 213, Condition J |
| Vibration | Mil-STD-202, Method 204, Condition B |
| Immersion | Mil-STD-202, Method 104, Condition B |
| Salt Spray | Mil-STD-202, Method 101, Condition B |
| Solderability | Mil-STD-202, Method 208 |
| Terminal Strength | Mil-STD-202, Method 211 |
| Temperature Cycling | Mil-STD-202, Method 102, Condition C |
| Barometric Pressure | Mil-STD-202, Method 105, Condition B |
| Resistance to Solder Heat | Mil-STD-202, Method 210, Condition C |

Case Size A

TABLE I: TC: M (+90±20PPM/°C)

| Cap. pF | Cap. Tol. | WVDC | Cap. pF | Cap. Tol. | WVDC | Cap. pF | Cap. Tol. | WVDC | Cap. pF | Cap. Tol. | WVDC |
|---------|-----------|----------|---------|-----------|----------|---------|------------|----------|---------|------------|----------|
| 0.1 | B | 150, 250 | 1.7 | B, C, D | 150, 250 | 6.2 | B, C, D | 150, 250 | 27 | F, G, J, K | 150, 250 |
| 0.2 | B | 150, 250 | 1.8 | B, C, D | 150, 250 | 6.8 | B, C, J, K | 150, 250 | 30 | F, G, J, K | 150, 250 |
| 0.3 | B,C | 150, 250 | 1.9 | B, C, D | 150, 250 | 7.5 | B, C, J, K | 150, 250 | 33 | F, G, J, K | 150, 250 |
| 0.4 | B,C | 150, 250 | 2.0 | B, C, D | 150, 250 | 8.2 | B, C, J, K | 150, 250 | 36 | F, G, J, K | 150, 250 |
| 0.5 | B, C, D | 150, 250 | 2.2 | B, C, D | 150, 250 | 9.1 | B, C, J, K | 150, 250 | 39 | F, G, J, K | 150, 250 |
| 0.6 | B, C, D | 150, 250 | 2.4 | B, C, D | 150, 250 | 10 | F, G, J, K | 150, 250 | 43 | F, G, J, K | 150, 250 |
| 0.7 | B, C, D | 150, 250 | 2.7 | B, C, D | 150, 250 | 11 | F, G, J, K | 150, 250 | 47 | F, G, J, K | 150, 250 |
| 0.8 | B, C, D | 150, 250 | 3.0 | B, C, D | 150, 250 | 12 | F, G, J, K | 150, 250 | 51 | F, G, J, K | 150, 250 |
| 0.9 | B, C, D | 150, 250 | 3.3 | B, C, D | 150, 250 | 13 | F, G, J, K | 150, 250 | 56 | F, G, J, K | 150, 250 |
| 1.0 | B, C, D | 150, 250 | 3.6 | B, C, D | 150, 250 | 15 | F, G, J, K | 150, 250 | 62 | F, G, J, K | 150, 250 |
| 1.1 | B, C, D | 150, 250 | 3.9 | B, C, D | 150, 250 | 16 | F, G, J, K | 150, 250 | 68 | F, G, J, K | 150, 250 |
| 1.2 | B, C, D | 150, 250 | 4.3 | B, C, D | 150, 250 | 18 | F, G, J, K | 150, 250 | 75 | F, G, J, K | 150, 250 |
| 1.3 | B, C, D | 150, 250 | 4.7 | B, C, D | 150, 250 | 20 | F, G, J, K | 150, 250 | 82 | F, G, J, K | 150, 250 |
| 1.4 | B, C, D | 150, 250 | 5.1 | B, C, D | 150, 250 | 22 | F, G, J, K | 150, 250 | 91 | F, G, J, K | 150, 250 |
| 1.5 | B, C, D | 150, 250 | 5.6 | B, C, D | 150, 250 | 24 | F, G, J, K | 150, 250 | 100 | F, G, J, K | 150, 250 |
| 1.6 | B, C, D | 150, 250 | | | | | | | | | |

TABLE II: TC: A (0±30PPM/°C)

| Cap. pF | Cap. Tol. | WVDC | Cap. pF | Cap. Tol. | WVDC | Cap. pF | Cap. Tol. | WVDC | Cap. pF | Cap. Tol. | WVDC |
|---------|-----------|----------|---------|------------|----------|---------|------------|----------|---------|------------|------|
| 0.1 | B | 150, 250 | 2.7 | B, C, D | 150, 250 | 20 | F, G, J, K | 150, 250 | 150 | F, G, J, K | 150 |
| 0.2 | B | 150, 250 | 3.0 | B, C, D | 150, 250 | 22 | F, G, J, K | 150, 250 | 160 | F, G, J, K | 150 |
| 0.3 | B,C | 150, 250 | 3.3 | B, C, D | 150, 250 | 24 | F, G, J, K | 150, 250 | 180 | F, G, J, K | 150 |
| 0.4 | B,C | 150, 250 | 3.6 | B, C, D | 150, 250 | 27 | F, G, J, K | 150, 250 | 200 | F, G, J, K | 150 |
| 0.5 | B, C, D | 150, 250 | 3.9 | B, C, D | 150, 250 | 30 | F, G, J, K | 150, 250 | 220 | F, G, J, K | 150 |
| 0.6 | B, C, D | 150, 250 | 4.3 | B, C, D | 150, 250 | 33 | F, G, J, K | 150, 250 | 240 | F, G, J, K | 150 |
| 0.7 | B, C, D | 150, 250 | 4.7 | B, C, D | 150, 250 | 36 | F, G, J, K | 150, 250 | 270 | F, G, J, K | 150 |
| 0.8 | B, C, D | 150, 250 | 5.1 | B, C, D | 150, 250 | 39 | F, G, J, K | 150, 250 | 300 | F, G, J, K | 150 |
| 0.9 | B, C, D | 150, 250 | 5.6 | B, C, D | 150, 250 | 43 | F, G, J, K | 150, 250 | 330 | F, G, J, K | 150 |
| 1.0 | B, C, D | 150, 250 | 6.2 | B, C, D | 150, 250 | 47 | F, G, J, K | 150, 250 | 360 | F, G, J, K | 150 |
| 1.1 | B, C, D | 150, 250 | 6.8 | B, C, J, K | 150, 250 | 51 | F, G, J, K | 150, 250 | 390 | F, G, J, K | 150 |
| 1.2 | B, C, D | 150, 250 | 7.5 | B, C, J, K | 150, 250 | 56 | F, G, J, K | 150, 250 | 430 | F, G, J, K | 150 |
| 1.3 | B, C, D | 150, 250 | 8.2 | B, C, J, K | 150, 250 | 62 | F, G, J, K | 150, 200 | 470 | F, G, J, K | 150 |
| 1.4 | B, C, D | 150, 250 | 9.1 | B, C, J, K | 150, 250 | 68 | F, G, J, K | 150, 200 | 510 | F, G, J, K | 150 |
| 1.5 | B, C, D | 150, 250 | 10 | F, G, J, K | 150, 250 | 75 | F, G, J, K | 150, 200 | 560 | F, G, J, K | 150 |
| 1.6 | B, C, D | 150, 250 | 11 | F, G, J, K | 150, 250 | 82 | F, G, J, K | 150, 200 | 620 | F, G, J, K | 150 |
| 1.7 | B, C, D | 150, 250 | 12 | F, G, J, K | 150, 250 | 91 | F, G, J, K | 150, 200 | 680 | F, G, J, K | 50 |
| 1.8 | B, C, D | 150, 250 | 13 | F, G, J, K | 150, 250 | 100 | F, G, J, K | 150 | 750 | F, G, J, K | 50 |
| 1.9 | B, C, D | 150, 250 | 15 | F, G, J, K | 150, 250 | 110 | F, G, J, K | 150 | 820 | F, G, J, K | 50 |
| 2.0 | B, C, D | 150, 250 | 16 | F, G, J, K | 150, 250 | 120 | F, G, J, K | 150 | 910 | F, G, J, K | 50 |
| 2.2 | B, C, D | 150, 250 | 18 | F, G, J, K | 150, 250 | 130 | F, G, J, K | 150 | 1000 | F, G, J, K | 50 |
| 2.4 | B, C, D | 150, 250 | | | | | | | | | |

TABLE III: TC: C (±15%)

| Cap. pF | Cap. Tol. | WVDC | Cap. pF | Cap. Tol. | WVDC | Cap. pF | Cap. Tol. | WVDC |
|---------|-----------|------|---------|-----------|------|---------|-----------|------|
| 1000 | K, M, N | 50 | 2200 | K, M, N | 50 | 5100 | K, M, N | 50 |
| 1200 | K, M, N | 50 | 2700 | K, M, N | 50 | 5600 | K, M, N | 50 |
| 1500 | K, M, N | 50 | 3300 | K, M, N | 50 | 6800 | K, M, N | 50 |
| 1800 | K, M, N | 50 | 3900 | K, M, N | 50 | 8200 | K, M, N | 50 |
| 2000 | K, M, N | 50 | 4700 | K, M, N | 50 | 10000 | K, M, N | 50 |

Case Size B

TABLE IV: TC: M (+90±20PPM/°C)

| Cap. pF | Cap. Tol. | WVDC | Cap. pF | Cap. Tol. | WVDC | Cap. pF | Cap. Tol. | WVDC | Cap. pF | Cap. Tol. | WVDC |
|---------|-----------|------|---------|------------|------|---------|------------|------|---------|------------|------|
| 0.1 | B | 500 | 2.7 | B, C, D | 500 | 20 | F, G, J, K | 500 | 150 | F, G, J, K | 300 |
| 0.2 | B | 500 | 3.0 | B, C, D | 500 | 22 | F, G, J, K | 500 | 160 | F, G, J, K | 300 |
| 0.3 | B,C | 500 | 3.3 | B, C, D | 500 | 24 | F, G, J, K | 500 | 180 | F, G, J, K | 300 |
| 0.4 | B,C | 500 | 3.6 | B, C, D | 500 | 27 | F, G, J, K | 500 | 200 | F, G, J, K | 300 |
| 0.5 | B, C, D | 500 | 3.9 | B, C, D | 500 | 30 | F, G, J, K | 500 | 220 | F, G, J, K | 200 |
| 0.6 | B, C, D | 500 | 4.3 | B, C, D | 500 | 33 | F, G, J, K | 500 | 240 | F, G, J, K | 200 |
| 0.7 | B, C, D | 500 | 4.7 | B, C, D | 500 | 36 | F, G, J, K | 500 | 270 | F, G, J, K | 200 |
| 0.8 | B, C, D | 500 | 5.1 | B, C, D | 500 | 39 | F, G, J, K | 500 | 300 | F, G, J, K | 200 |
| 0.9 | B, C, D | 500 | 5.6 | B, C, D | 500 | 43 | F, G, J, K | 500 | 330 | F, G, J, K | 200 |
| 1.0 | B, C, D | 500 | 6.2 | B, C, D | 500 | 47 | F, G, J, K | 500 | 360 | F, G, J, K | 200 |
| 1.1 | B, C, D | 500 | 6.8 | B, C, J, K | 500 | 51 | F, G, J, K | 500 | 390 | F, G, J, K | 200 |
| 1.2 | B, C, D | 500 | 7.5 | B, C, J, K | 500 | 56 | F, G, J, K | 500 | 430 | F, G, J, K | 200 |
| 1.3 | B, C, D | 500 | 8.2 | B, C, J, K | 500 | 62 | F, G, J, K | 500 | 470 | F, G, J, K | 200 |
| 1.4 | B, C, D | 500 | 9.1 | B, C, J, K | 500 | 68 | F, G, J, K | 500 | 510 | F, G, J, K | 150 |
| 1.5 | B, C, D | 500 | 10 | F, G, J, K | 500 | 75 | F, G, J, K | 500 | 560 | F, G, J, K | 150 |
| 1.6 | B, C, D | 500 | 11 | F, G, J, K | 500 | 82 | F, G, J, K | 500 | 620 | F, G, J, K | 150 |
| 1.7 | B, C, D | 500 | 12 | F, G, J, K | 500 | 91 | F, G, J, K | 500 | 680 | F, G, J, K | 150 |
| 1.8 | B, C, D | 500 | 13 | F, G, J, K | 500 | 100 | F, G, J, K | 500 | 750 | F, G, J, K | 150 |
| 1.9 | B, C, D | 500 | 15 | F, G, J, K | 500 | 110 | F, G, J, K | 300 | 820 | F, G, J, K | 150 |
| 2.0 | B, C, D | 500 | 16 | F, G, J, K | 500 | 120 | F, G, J, K | 300 | 910 | F, G, J, K | 150 |
| 2.2 | B, C, D | 500 | 18 | F, G, J, K | 500 | 130 | F, G, J, K | 300 | 1000 | F, G, J, K | 150 |
| 2.4 | B, C, D | 500 | | | | | | | | | |

TABLE V: TC: A (0±30PPM/°C)

| Cap. pF | Cap. Tol. | WVDC | Cap. pF | Cap. Tol. | WVDC | Cap. pF | Cap. Tol. | WVDC | Cap. pF | Cap. Tol. | WVDC |
|---------|-----------|------|---------|------------|------|---------|------------|------|---------|------------|------|
| 0.1 | B | 500 | 3.9 | B, C, D | 500 | 47 | F, G, J, K | 500 | 560 | F, G, J, K | 150 |
| 0.2 | B | 500 | 4.3 | B, C, D | 500 | 51 | F, G, J, K | 500 | 620 | F, G, J, K | 150 |
| 0.3 | B,C | 500 | 4.7 | B, C, D | 500 | 56 | F, G, J, K | 500 | 680 | F, G, J, K | 150 |
| 0.4 | B,C | 500 | 5.1 | B, C, D | 500 | 62 | F, G, J, K | 500 | 750 | F, G, J, K | 150 |
| 0.5 | B, C, D | 500 | 5.6 | B, C, D | 500 | 68 | F, G, J, K | 500 | 820 | F, G, J, K | 150 |
| 0.6 | B, C, D | 500 | 6.2 | B, C, D | 500 | 75 | F, G, J, K | 500 | 910 | F, G, J, K | 150 |
| 0.7 | B, C, D | 500 | 6.8 | B, C, J, K | 500 | 82 | F, G, J, K | 500 | 1000 | F, G, J, K | 150 |
| 0.8 | B, C, D | 500 | 7.5 | B, C, J, K | 500 | 91 | F, G, J, K | 500 | 1100 | F, G, J, K | 50 |
| 0.9 | B, C, D | 500 | 8.2 | B, C, J, K | 500 | 100 | F, G, J, K | 500 | 1200 | F, G, J, K | 50 |
| 1.0 | B, C, D | 500 | 9.1 | B, C, J, K | 500 | 110 | F, G, J, K | 300 | 1300 | F, G, J, K | 50 |
| 1.1 | B, C, D | 500 | 10 | F, G, J, K | 500 | 120 | F, G, J, K | 300 | 1500 | F, G, J, K | 50 |
| 1.2 | B, C, D | 500 | 11 | F, G, J, K | 500 | 130 | F, G, J, K | 300 | 1600 | F, G, J, K | 50 |
| 1.3 | B, C, D | 500 | 12 | F, G, J, K | 500 | 150 | F, G, J, K | 300 | 1800 | F, G, J, K | 50 |
| 1.4 | B, C, D | 500 | 13 | F, G, J, K | 500 | 160 | F, G, J, K | 300 | 2000 | F, G, J, K | 50 |
| 1.5 | B, C, D | 500 | 15 | F, G, J, K | 500 | 180 | F, G, J, K | 300 | 2200 | F, G, J, K | 50 |
| 1.6 | B, C, D | 500 | 16 | F, G, J, K | 500 | 200 | F, G, J, K | 300 | 2400 | F, G, J, K | 50 |
| 1.7 | B, C, D | 500 | 18 | F, G, J, K | 500 | 220 | F, G, J, K | 200 | 2700 | F, G, J, K | 50 |
| 1.8 | B, C, D | 500 | 20 | F, G, J, K | 500 | 240 | F, G, J, K | 200 | 3000 | F, G, J, K | 50 |
| 1.9 | B, C, D | 500 | 22 | F, G, J, K | 500 | 270 | F, G, J, K | 200 | 3300 | F, G, J, K | 50 |
| 2.0 | B, C, D | 500 | 24 | F, G, J, K | 500 | 300 | F, G, J, K | 200 | 3600 | F, G, J, K | 50 |
| 2.2 | B, C, D | 500 | 27 | F, G, J, K | 500 | 330 | F, G, J, K | 200 | 3900 | F, G, J, K | 50 |
| 2.4 | B, C, D | 500 | 30 | F, G, J, K | 500 | 360 | F, G, J, K | 200 | 4300 | F, G, J, K | 50 |
| 2.7 | B, C, D | 500 | 33 | F, G, J, K | 500 | 390 | F, G, J, K | 200 | 4700 | F, G, J, K | 50 |
| 3.0 | B, C, D | 500 | 36 | F, G, J, K | 500 | 430 | F, G, J, K | 200 | 5000 | F, G, J, K | 50 |
| 3.3 | B, C, D | 500 | 39 | F, G, J, K | 500 | 470 | F, G, J, K | 200 | 5100 | F, G, J, K | 50 |
| 3.6 | B, C, D | 500 | 43 | F, G, J, K | 500 | 510 | F, G, J, K | 150 | | | |

TABLE VI: TC: C (±15%)

| Cap. pF | Cap. Tol. | WVDC | Cap. pF | Cap. Tol. | WVDC | Cap. pF | Cap. Tol. | WVDC |
|---------|-----------|------|---------|-----------|------|---------|-----------|------|
| 5000 | K, M, N | 50 | 15000 | K, M, N | 50 | 47000 | K, M, N | 50 |
| 6800 | K, M, N | 50 | 18000 | K, M, N | 50 | 68000 | K, M, N | 50 |
| 8200 | K, M, N | 50 | 27000 | K, M, N | 50 | 82000 | K, M, N | 50 |
| 10000 | K, M, N | 50 | 33000 | K, M, N | 50 | 100000 | K, M, N | 50 |
| 12000 | K, M, N | 50 | 39000 | K, M, N | 50 | | | |

Microwave MLC's

SQ Series Ultra Low ESR MLC

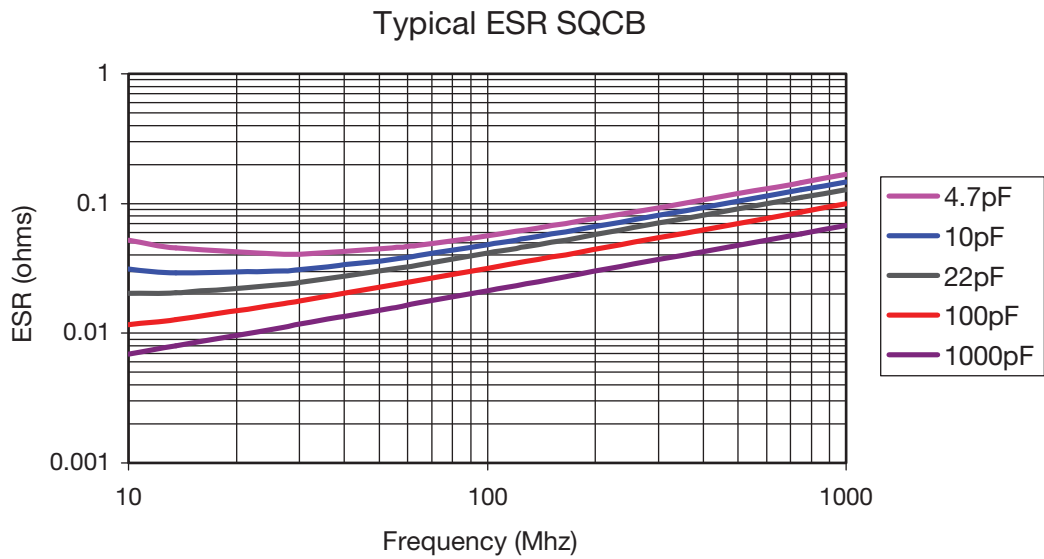
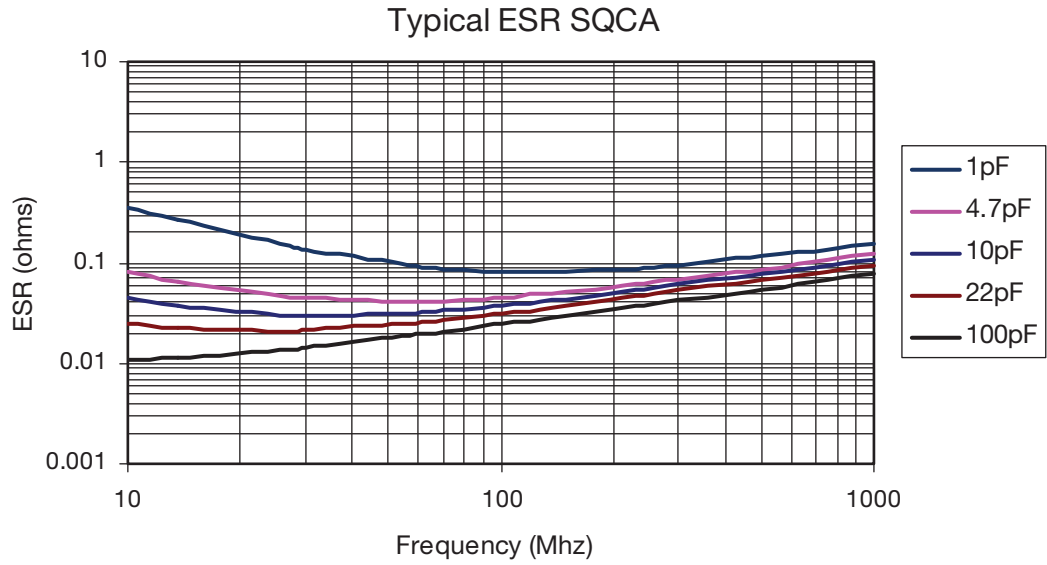

Microwave MLC's

SQ Series Ultra Low ESR MLC

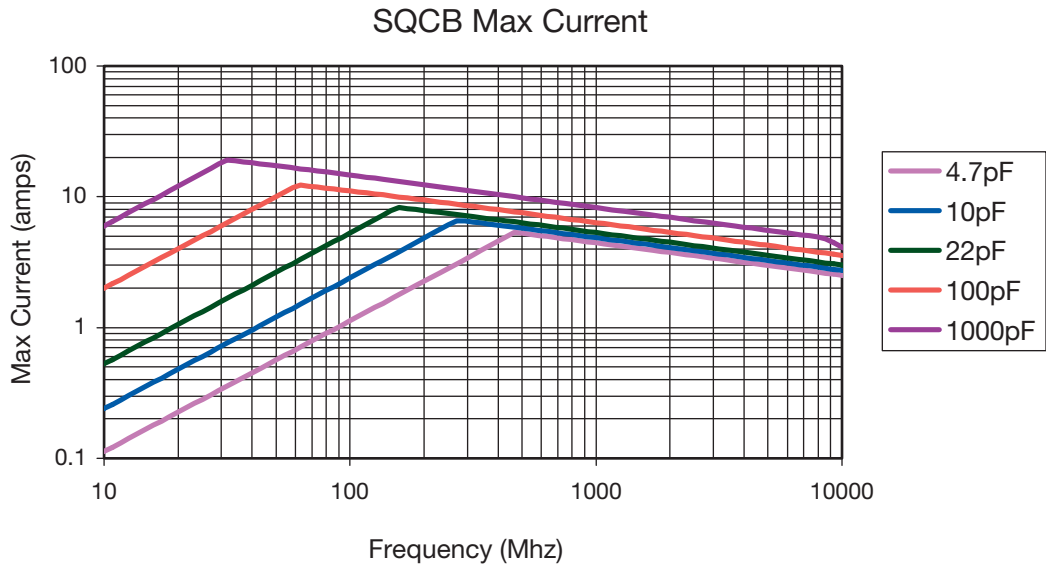
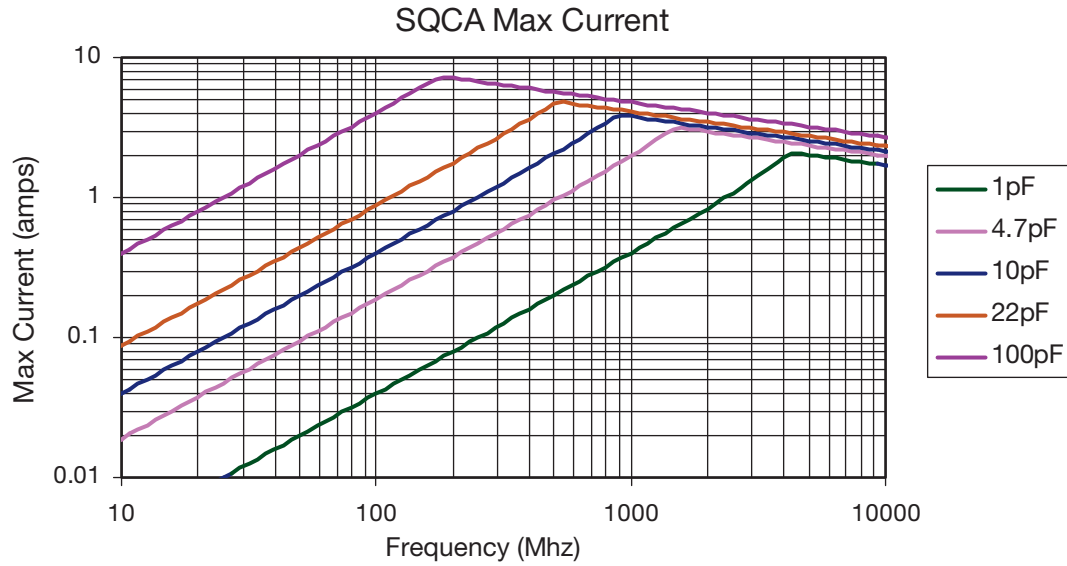

Microwave MLC's

SQ Series Ultra Low ESR MLC

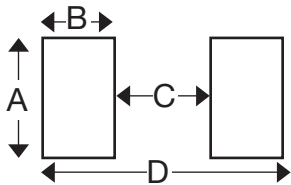
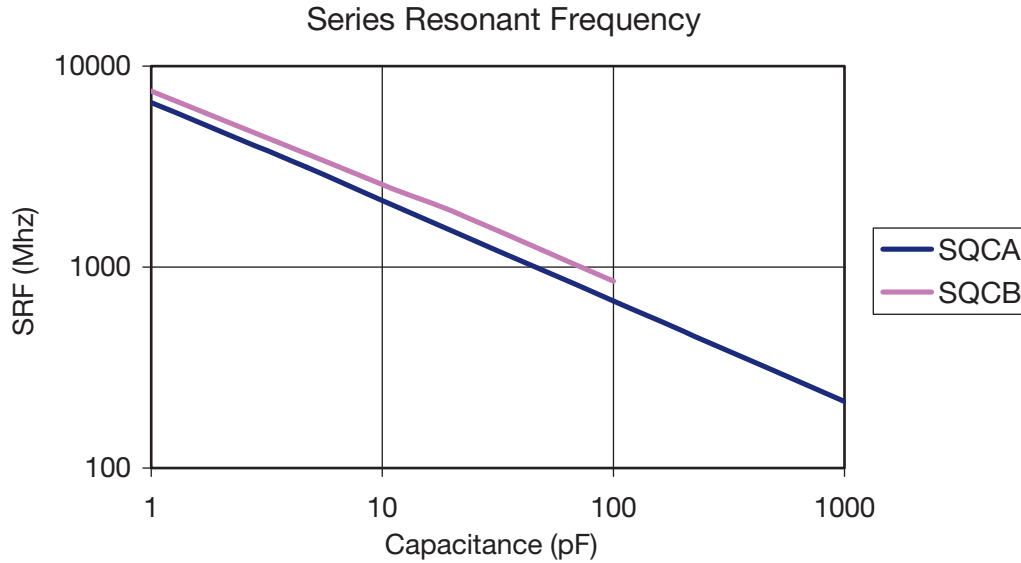

MOUNTING PAD DIMENSIONS: inches (millimeters)

| Case | A min | B min | C min | D min |
|------|---------------|---------------|---------------|---------------|
| SQCA | 0.082 (2.083) | 0.051 (1.295) | 0.032 (0.813) | 0.130 (3.302) |
| SQCB | 0.131 (3.327) | 0.051 (1.295) | 0.074 (1.880) | 0.177 (4.496) |
| SQCS | 0.038 (0.965) | 0.043 (1.092) | 0.025 (0.635) | 0.112 (2.845) |
| SQCF | 0.059 (1.499) | 0.051 (1.295) | 0.024 (0.610) | 0.125 (3.175) |

SQCA & SQCB DESIGN KITS

| PN | Series | Diel | Term | Range | Different Values | # per value |
|-------------|--------|------|------------------|-----------------|------------------|-------------|
| KITSQ100LF | SQCA | P90 | 100% Tin RoHS | .1 to 2pF | 16 | 15 |
| KITSQ400LF | | C0G | | | | |
| KITSQ200LF | SQCA | P90 | 100% Tin RoHS | 1 to 10pF | 16 | 15 |
| KITSQ500LF | | C0G | | | | |
| KITSQ300LF | SQCA | P90 | 100% Tin RoHS | 10 to 100pF | 16 | 15 |
| KITSQ600LF | | C0G | | | | |
| KITSQ700LF | SQCA | C0G | 100% Tin RoHS | 100 to 1000pF | 16 | 15 |
| KITSQ800LF | SQCB | P90 | 100% Tin RoHS | 1 to 10pF | 16 | 15 |
| KITSQ1100LF | | C0G | | | | |
| KITSQ900LF | SQCB | P90 | 100% Tin RoHS | 10 to 100pF | 16 | 15 |
| KITSQ1200LF | | C0G | | | | |
| KITSQ1000LF | SQCB | P90 | 100% Tin RoHS | 100 to 1000pF | 16 | 15 |
| KITSQ1300LF | | C0G | | | | |
| KITSQ1400LF | SQCB | C0G | 100% Tin RoHS | 1000 to 5100 pF | 11 | 15 |



Microwave MLC's



SQCS (0603) SQCF (0805) Ultra Low ESR MLC

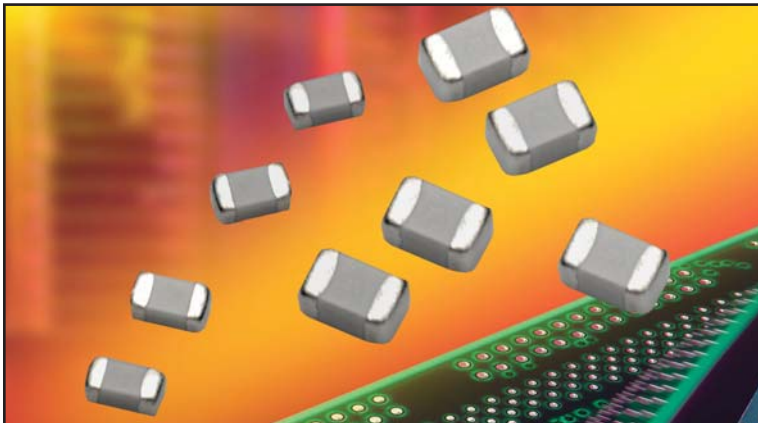

FEATURES:

- Low ESR
- High Q
- High Self Resonance
- Capacitance Range 0.1 pF to 240 pF
- EIA Size

APPLICATIONS:

- RF Power Amplifiers
- Low Noise Amplifiers
- Filter Networks
- Point to Point Radios

HOW TO ORDER

| | | | | | | | | |
|-----------------------------------|---|--|--|---|---|---|---|--|
| <p>SQ</p> <p>AVX Style</p> | <p>CS</p> <p>Case Size CS = 0603 CF = 0805</p> | <p>V</p> <p>Voltage Code V = 250V</p> | <p>A</p> <p>Temperature Coefficient Code A = 0±30ppm/°C</p> | <p>100</p> <p>Capacitance EIA Capacitance Code in pF. First two digits = significant figures or "R" for decimal place. Third digit = number of zeros or after "R" significant figures.</p> | <p>J</p> <p>Capacitance Tolerance Code A = ±.05 pF B = ±.1 pF C = ±.25 pF D = ±.5 pF F = ±1% G = ±2% J = ±5%</p> | <p>A</p> <p>Failure Rate Code A = Not Applicable</p> | <p>T</p> <p>Termination Style Code **1 = Pd/Ag **7 = Ag/Ni/Au J = Nickel Barrier Sn/Pb (60/40) **T = 100% Tin (Standard)</p> | <p>1A</p> <p>Packaging Code 1A = 7" Reel Unmarked ME = 7" Reel Marked</p> <p>* Vertical T&R available * 500 piece reels available</p> |
|-----------------------------------|---|--|--|---|---|---|---|--|

****RoHS compliant**

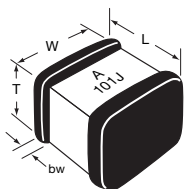

MECHANICAL DIMENSIONS: inches (millimeters)

| Case | Length (L) | Width (W) | Thickness (T) | Band Width (bw) |
|------|--------------------------|--------------------------|---------------------|--------------------------|
| SQCS | .063±.006 (1.60±.152) | .032±.006 (.813±.152) | .030 Max. (.762) | .014±.006 (.357±.152) |
| SQCF | .079±.008 (2.01±.200) | .049±.008 (1.24±.200) | .045 Max. (1.14) | .014±.006 (.357±.152) |

TAPE & REEL: All tape and reel specifications are in compliance with EIA RS481 (equivalent to IEC 286 part 3).

- 8mm carrier
- 7" reel = 4000 pcs (500 piece options)

Not RoHS Compliant



For RoHS compliant products, please select correct termination style.



Microwave MLC's

Low ESR MLC Capacitors



ELECTRICAL SPECIFICATIONS

| | |
|---------------------------------------|---|
| Temperature Coefficient (TCC) | (A) 0 ± 30 PPM/°C |
| Operating Temperature | -55°C to +125°C |
| Quality Factor (Q) | Greater than 10,000 at 1 MHz |
| Insulation Resistance (IR) | 0.1 pF to 240 pF 10 ⁸ Megohms min. @ 25°C at rated WVDC 10 ⁴ Megohms min. @ 125°C at rated WVDC |
| Working Voltage (WVDC) | See Capacitance Values table |
| Dielectric Withstanding Voltage (DWV) | 250% of rated WVDC for 5 secs |
| Aging Effects | None |
| Piezoelectric Effects | None |
| Capacitance Drift | ± (0.02% or 0.02 pF), whichever is greater |

ENVIRONMENTAL CHARACTERISTICS

AVX SQ will meet and exceed the requirements of EIA-198, MIL-PRF-55681 and MIL-PRF-123

| | |
|---------------------------|---|
| Thermal Shock | Mil-STD-202, Method 107, Condition A |
| Moisture Resistance | Mil-STD-202, Method 106 |
| Low Voltage Humidity | Mil-STD-202, Method 103, condition A, with 1.5 VDC applied while subjected to an environment of 85°C with 85% relative humidity for 240 hours |
| Life Test | Mil-STD-202, Method 108, for 2000 hours at 125°C |
| Shock | Mil-STD-202, Method 213, Condition J |
| Vibration | Mil-STD-202, Method 204, Condition B |
| Immersion | Mil-STD-202, Method 104, Condition B |
| Salt Spray | Mil-STD-202, Method 101, Condition B |
| Solderability | Mil-STD-202, Method 208 |
| Terminal Strength | Mil-STD-202, Method 211 |
| Temperature Cycling | Mil-STD-202, Method 102, Condition C |
| Barometric Pressure | Mil-STD-202, Method 105, Condition B |
| Resistance to Solder Heat | Mil-STD-202, Method 210, Condition C |

Microwave MLC's



SQ Series Available Capacitance/Size/WVDC/T.C.

TABLE I: TC: A (0±30PPM/°C) CASE SIZE S

| Cap. pF | Cap. Tol. | WVDC | Cap. pF | Cap. Tol. | WVDC | Cap. pF | Cap. Tol. | WVDC |
|---------|-----------|------|---------|-----------|------|---------|-----------|------|
| 0.1 | A, B | 250 | 2.4 | A, B, C | 250 | 18 | F, G, J | 250 |
| 0.2 | A, B | 250 | 2.7 | A, B, C | 250 | 20 | F, G, J | 250 |
| 0.3 | A, B | 250 | 3.0 | A, B, C | 250 | 22 | F, G, J | 250 |
| 0.4 | A, B | 250 | 3.3 | A, B, C | 250 | 24 | F, G, J | 250 |
| 0.5 | A, B, C | 250 | 3.6 | A, B, C | 250 | 27 | F, G, J | 250 |
| 0.6 | A, B, C | 250 | 3.9 | A, B, C | 250 | 30 | F, G, J | 250 |
| 0.7 | A, B, C | 250 | 4.3 | A, B, C | 250 | 33 | F, G, J | 250 |
| 0.8 | A, B, C | 250 | 4.7 | A, B, C | 250 | 36 | F, G, J | 250 |
| 0.9 | A, B, C | 250 | 5.1 | A, B, C | 250 | 39 | F, G, J | 250 |
| 1.0 | A, B, C | 250 | 5.6 | A, B, C | 250 | 43 | F, G, J | 250 |
| 1.1 | A, B, C | 250 | 6.2 | A, B, C | 250 | 47 | F, G, J | 250 |
| 1.2 | A, B, C | 250 | 6.8 | B, C, D | 250 | 51 | F, G, J | 250 |
| 1.3 | A, B, C | 250 | 7.5 | B, C, D | 250 | 56 | F, G, J | 250 |
| 1.4 | A, B, C | 250 | 8.2 | B, C, D | 250 | 62 | F, G, J | 250 |
| 1.5 | A, B, C | 250 | 9.1 | B, C, D | 250 | 68 | F, G, J | 250 |
| 1.6 | A, B, C | 250 | 10 | F, G, J | 250 | 75 | F, G, J | 250 |
| 1.7 | A, B, C | 250 | 11 | F, G, J | 250 | 82 | F, G, J | 250 |
| 1.8 | A, B, C | 250 | 12 | F, G, J | 250 | 91 | F, G, J | 250 |
| 1.9 | A, B, C | 250 | 13 | F, G, J | 250 | 100 | F, G, J | 250 |
| 2.0 | A, B, C | 250 | 15 | F, G, J | 250 | | | |
| 2.2 | A, B, C | 250 | 16 | F, G, J | 250 | | | |

TABLE II: TC: A (0±30PPM/°C) CASE SIZE F

| Cap. pF | Cap. Tol. | WVDC | Cap. pF | Cap. Tol. | WVDC | Cap. pF | Cap. Tol. | WVDC | Cap. pF | Cap. Tol. | WVDC |
|---------|-----------|------|---------|-----------|------|---------|-----------|------|---------|-----------|------|
| 0.1 | A, B | 250 | 2.4 | A, B, C | 250 | 18 | F, G, J | 250 | 150 | F, G, J | 250 |
| 0.2 | A, B | 250 | 2.7 | A, B, C | 250 | 20 | F, G, J | 250 | 180 | F, G, J | 250 |
| 0.3 | A, B | 250 | 3.0 | A, B, C | 250 | 22 | F, G, J | 250 | 200 | F, G, J | 250 |
| 0.4 | A, B | 250 | 3.3 | A, B, C | 250 | 24 | F, G, J | 250 | 220 | F, G, J | 250 |
| 0.5 | A, B, C | 250 | 3.6 | A, B, C | 250 | 27 | F, G, J | 250 | 240 | F, G, J | 250 |
| 0.6 | A, B, C | 250 | 3.9 | A, B, C | 250 | 30 | F, G, J | 250 | | | |
| 0.7 | A, B, C | 250 | 4.3 | A, B, C | 250 | 33 | F, G, J | 250 | | | |
| 0.8 | A, B, C | 250 | 4.7 | A, B, C | 250 | 36 | F, G, J | 250 | | | |
| 0.9 | A, B, C | 250 | 5.1 | A, B, C | 250 | 39 | F, G, J | 250 | | | |
| 1.0 | A, B, C | 250 | 5.6 | A, B, C | 250 | 43 | F, G, J | 250 | | | |
| 1.1 | A, B, C | 250 | 6.2 | A, B, C | 250 | 47 | F, G, J | 250 | | | |
| 1.2 | A, B, C | 250 | 6.8 | B, C, D | 250 | 51 | F, G, J | 250 | | | |
| 1.3 | A, B, C | 250 | 7.5 | B, C, D | 250 | 56 | F, G, J | 250 | | | |
| 1.4 | A, B, C | 250 | 8.2 | B, C, D | 250 | 62 | F, G, J | 250 | | | |
| 1.5 | A, B, C | 250 | 9.1 | B, C, D | 250 | 68 | F, G, J | 250 | | | |
| 1.6 | A, B, C | 250 | 10 | F, G, J | 250 | 75 | F, G, J | 250 | | | |
| 1.7 | A, B, C | 250 | 11 | F, G, J | 250 | 82 | F, G, J | 250 | | | |
| 1.8 | A, B, C | 250 | 12 | F, G, J | 250 | 91 | F, G, J | 250 | | | |
| 1.9 | A, B, C | 250 | 13 | F, G, J | 250 | 100 | F, G, J | 250 | | | |
| 2.0 | A, B, C | 250 | 15 | F, G, J | 250 | 110 | F, G, J | 250 | | | |
| 2.2 | A, B, C | 250 | 16 | F, G, J | 250 | 120 | F, G, J | 250 | | | |

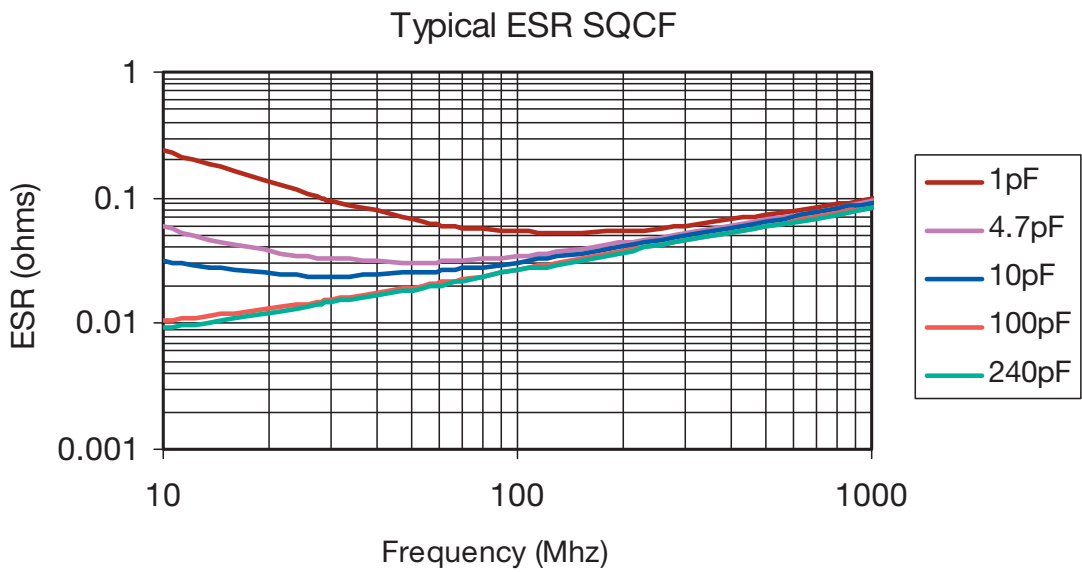
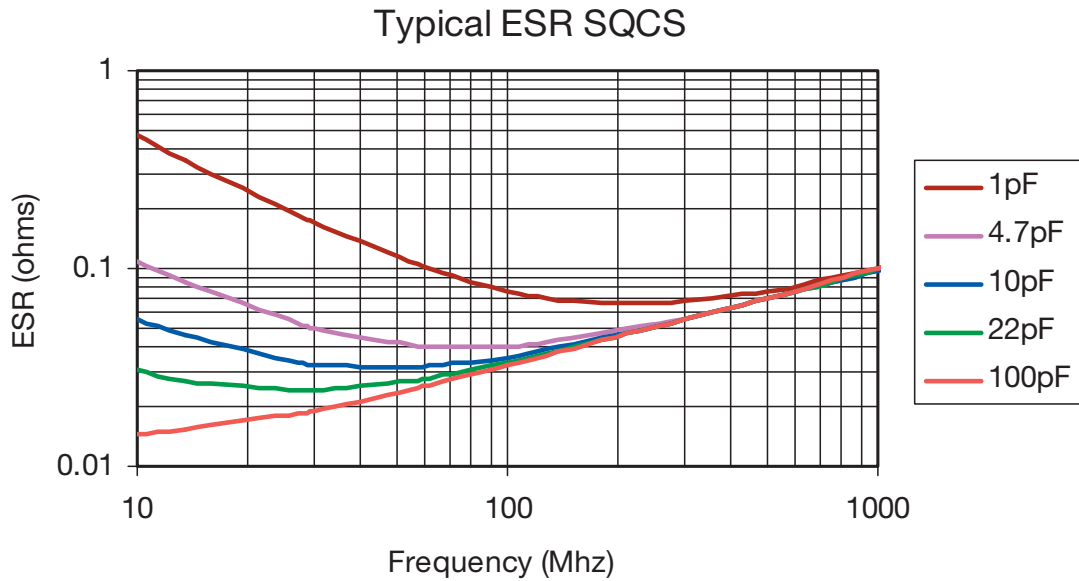

Microwave MLC's

SQCS (0603) SQCF (0805) Ultra Low ESR MLC



Max Current SQCS

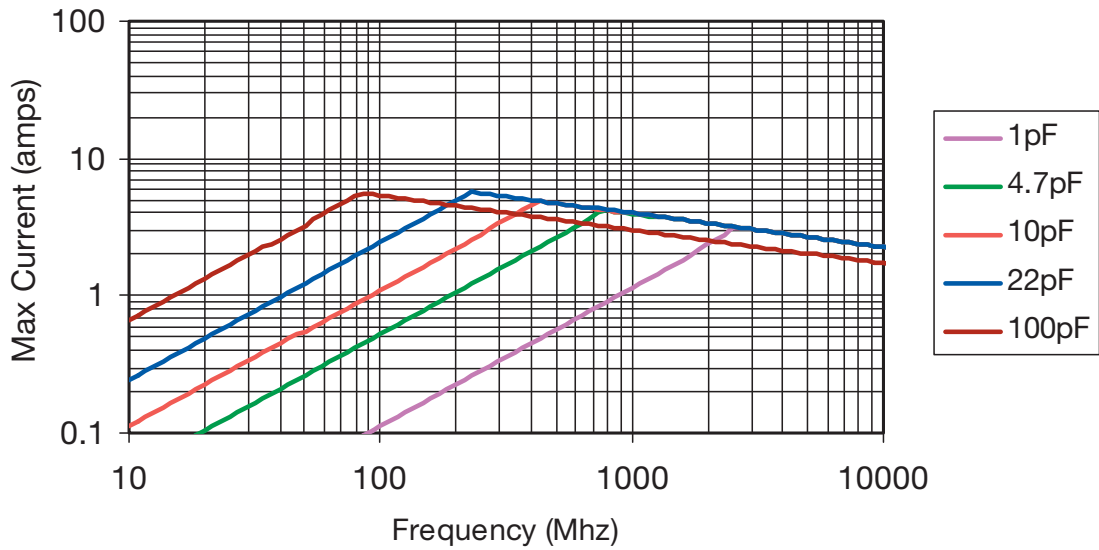

Max Current SQCF

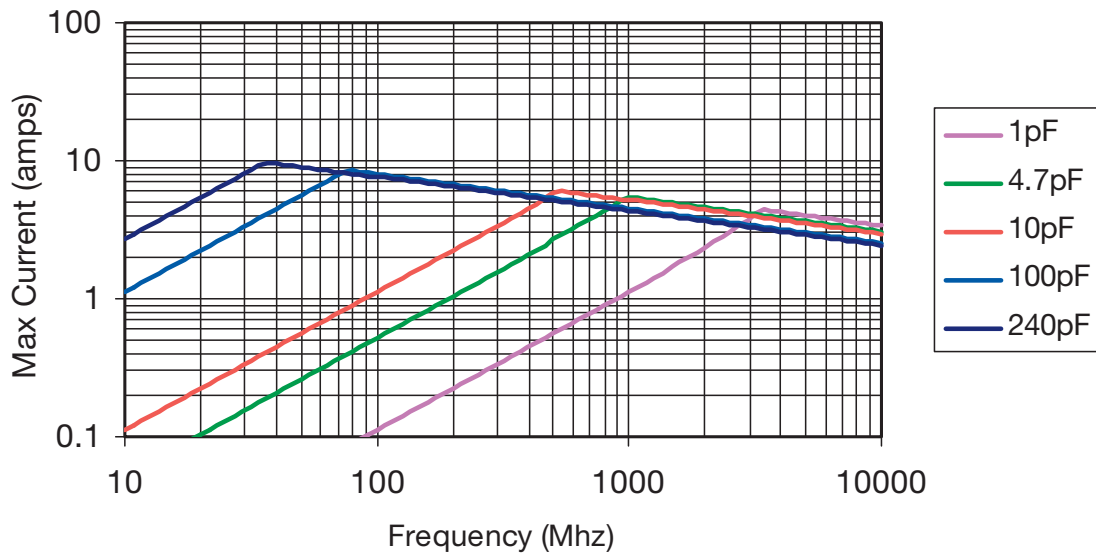

Microwave MLC's

SQCS (0603) SQCF (0805) Ultra Low ESR MLC

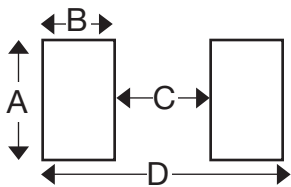
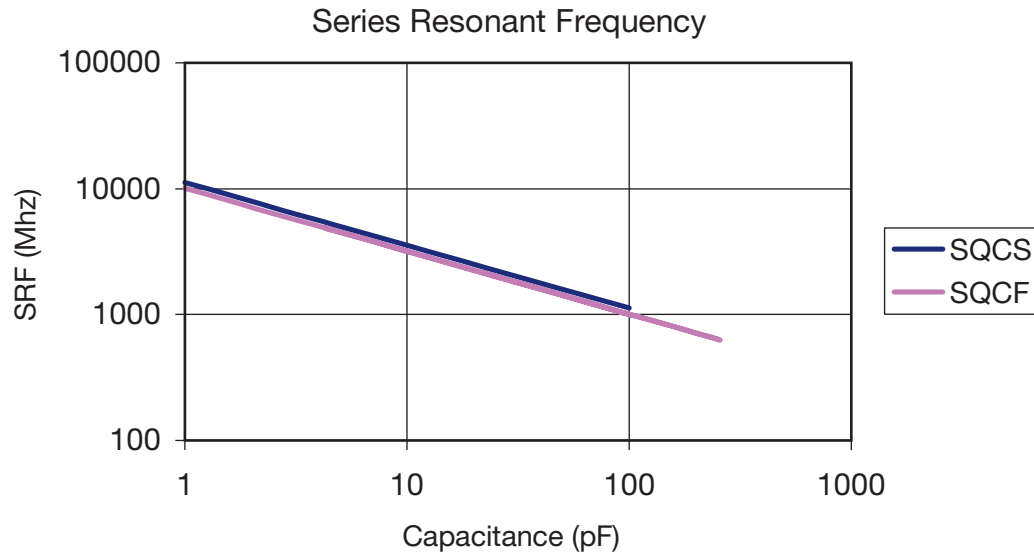

MOUNTING PAD DIMENSIONS: inches (millimeters)

| Case | A min | B min | C min | D min |
|------|---------------|---------------|---------------|---------------|
| SQCA | 0.082 (2.083) | 0.051 (1.295) | 0.032 (0.813) | 0.130 (3.302) |
| SQCB | 0.131 (3.327) | 0.051 (1.295) | 0.074 (1.880) | 0.177 (4.496) |
| SQCS | 0.038 (0.965) | 0.043 (1.092) | 0.025 (0.635) | 0.112 (2.845) |
| SQCF | 0.059 (1.499) | 0.051 (1.295) | 0.024 (0.610) | 0.125 (3.175) |

SQCS & SQCF ENGINEERING KITS

| PN | Series | Diel | Term | Range | Different Values | # per value |
|--------------|--------|------|----------|-------------|------------------|-------------|
| Kit SQ1800LF | SQCF | C0G | 100% Tin | .1 to 10pF | 27 | 15 |
| Kit SQ1900LF | | | RoHS | 10 to 240pF | 22 | |
| Kit SQ1500LF | SQCS | C0G | 100% Tin | .1 to 10pF | 27 | 15 |
| Kit SQ1600LF | | | RoHS | 10 to 100pF | 16 | |

| Tolerance per PF: | |
|-------------------|------------------|
| B from .1 to 3.3 | J from 10 to 240 |
| C from 3.9 to 8.2 | |

MK Series Capacitors



Ultra Low ESR, C0G (NP0) Chip Capacitors

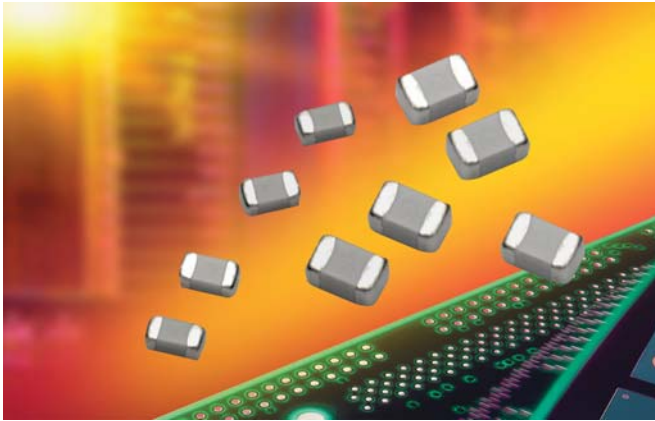

GENERAL INFORMATION

Capacitors are C0G (NP0) chip capacitors specially designed for "Ultra" low ESR for applications in the communications market. Max ESR and effective capacitance are met on each value producing lot to lot uniformity. Sizes available are EIA chip sizes 0402, 0603, 0805, and 1210.

DIMENSIONS: inches (millimeters)

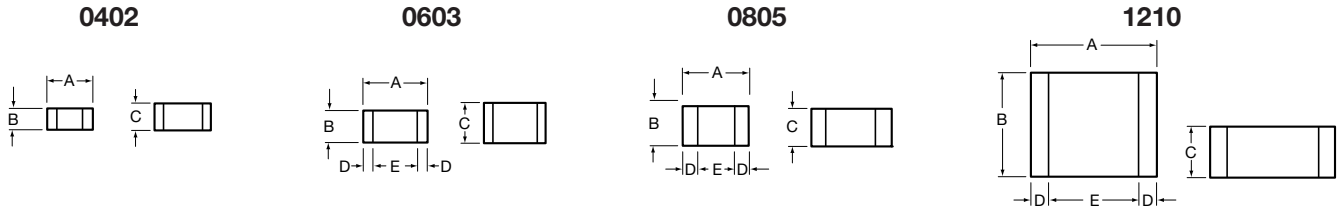

| Size | A | B | C | D | E |
|------|-------------------------|-------------------------|--------------------------|---------------------------|------------------|
| 0402 | 0.039±0.004 (1.00±0.1) | 0.020±0.004 (0.50±0.1) | 0.024 (0.6) max | N/A | N/A |
| 0603 | 0.060±0.010 (1.52±0.25) | 0.030±0.010 (0.76±0.25) | 0.036 (0.91) max | 0.010±0.005 (0.25±0.13) | 0.030 (0.76) min |
| 0805 | 0.079±0.008 (2.01±0.2) | 0.049±0.008 (1.25±0.2) | 0.040±0.005 (1.02±0.127) | 0.020±0.010 (0.51±0.254) | 0.020 (0.51) min |
| 1210 | 0.126±0.008 (3.2±0.2) | 0.098±0.008 (2.49±0.2) | 0.050±0.005 (1.27±0.127) | 0.025±0.015 (0.635±0.381) | 0.040 (1.02) min |

HOW TO ORDER

| | | | | | | | | |
|--|--|---|--|--|--|--|--|---|
| <p>MK05</p> <p>Case Size</p> <p>MK02 = 0402 MK03 = 0603 MK05 = 0805 MK10 = 1210</p> | <p>V</p> <p>Voltage Code</p> <p>3 = 25V 5 = 50V 1 = 100V 2 = 200V V = 250V 7 = 500V</p> | <p>7</p> <p>Dielectric = Ultra Low ESR</p> | <p>100</p> <p>Capacitance</p> <p>EIA Capacitance Code in pF.</p> <p>First two digits = significant figures or "R" for decimal place.</p> <p>Third digit = number of zeros or after "R" significant figures.</p> | <p>J</p> <p>Capacitance Tolerance Code</p> <p>B = ±0.1pF C = ±0.25pF D = ±0.5pF F = ±1% G = ±2% J = ±5% K = ±10% M = ±20%</p> | <p>A</p> <p>Failure Rate Code</p> <p>A = Not Applicable</p> | <p>T</p> <p>Termination</p> <p>T = 100% Tin</p> | <p>2</p> <p>Packaging Code</p> <p>2 = 7" Reel 4 = 13" Reel 9 = Bulk</p> | <p>A</p> <p>Special Code</p> <p>A = Standard</p> |
|--|--|---|--|--|--|--|--|---|



MK Series Capacitors



Ultra Low ESR, C0G (NP0) Chip Capacitors

ELECTRICAL CHARACTERISTICS

Capacitance Values and Tolerances:

- Size MK02 - 0.2 pF to 30 pF @ 1 MHz
- Size MK03 - 0.2 pF to 120 pF @ 1 MHz
- Size MK05 - 1.0 pF to 160 pF @ 1 MHz
- Size MK10 - 1.0 pF to 1000 pF @ 1 MHz

Temperature Coefficient of Capacitance (TC):

0±30 ppm/°C (-55° to +125°C)

Insulation Resistance (IR):

- 10¹² Ω min. @ 25°C and rated WVDC
- 10¹¹ Ω min. @ 125°C and rated WVDC

Working Voltage (WVDC):

- Size Working Voltage
- MK02 - 50, 25 WVDC
- MK03 - 250, 200, 100, 50 WVDC
- MK05 - 250 WVDC
- MK10 - 500, 200, 100 WVDC

Dielectric Working Voltage (DWV):

250% of rated WVDC

Equivalent Series Resistance Typical (ESR):

- MK02 - See Performance Curve, page 207
- MK03 - See Performance Curve, page 207
- MK05 - See Performance Curve, page 207
- MK10 - See Performance Curve, page 207

MILITARY SPECIFICATIONS

Meets or exceeds the requirements of MIL-C-55681

CAPACITANCE RANGE

| Cap (pF) | Available | Size | | | |
|----------|-----------|------|------|------|------|
| | Tolerance | MK02 | MK03 | MK05 | MK10 |
| 0.2 | B,C | 50V | 250V | N/A | N/A |
| 0.3 | ↓ | ↓ | ↓ | ↓ | ↓ |
| 0.4 | ↓ | ↓ | ↓ | ↓ | ↓ |
| 0.5 | B,C | ↓ | ↓ | ↓ | ↓ |
| 0.6 | B,C,D | ↓ | ↓ | ↓ | ↓ |
| 0.7 | ↓ | ↓ | ↓ | ↓ | ↓ |
| 0.8 | ↓ | ↓ | ↓ | ↓ | ↓ |
| 0.9 | B,C,D | ↓ | ↓ | ↓ | ↓ |

| Cap (pF) | Available | Size | | | |
|----------|-----------|------|------|------|------|
| | Tolerance | MK02 | MK03 | MK05 | MK10 |
| 1.0 | B,C,D | 50V | 250V | 250V | 500V |
| 1.1 | ↓ | ↓ | ↓ | ↓ | ↓ |
| 1.2 | ↓ | ↓ | ↓ | ↓ | ↓ |
| 1.3 | ↓ | ↓ | ↓ | ↓ | ↓ |
| 1.4 | ↓ | ↓ | ↓ | ↓ | ↓ |
| 1.5 | ↓ | ↓ | ↓ | ↓ | ↓ |
| 1.6 | ↓ | ↓ | ↓ | ↓ | ↓ |
| 1.7 | ↓ | ↓ | ↓ | ↓ | ↓ |
| 1.8 | ↓ | ↓ | ↓ | ↓ | ↓ |
| 1.9 | ↓ | ↓ | ↓ | ↓ | ↓ |
| 2.0 | ↓ | ↓ | ↓ | ↓ | ↓ |
| 2.1 | ↓ | ↓ | ↓ | ↓ | ↓ |
| 2.2 | ↓ | ↓ | ↓ | ↓ | ↓ |
| 2.4 | ↓ | ↓ | ↓ | ↓ | ↓ |
| 2.7 | ↓ | ↓ | ↓ | ↓ | ↓ |
| 3.0 | ↓ | ↓ | ↓ | ↓ | ↓ |
| 3.3 | ↓ | ↓ | ↓ | ↓ | ↓ |
| 3.6 | ↓ | ↓ | ↓ | ↓ | ↓ |
| 3.9 | ↓ | ↓ | ↓ | ↓ | ↓ |
| 4.3 | ↓ | ↓ | ↓ | ↓ | ↓ |
| 4.7 | ↓ | ↓ | ↓ | ↓ | ↓ |
| 5.1 | ↓ | ↓ | ↓ | ↓ | ↓ |
| 5.6 | ↓ | ↓ | ↓ | ↓ | ↓ |
| 6.2 | B,C,D | ↓ | ↓ | ↓ | ↓ |
| 6.8 | B,C,J,K,M | ↓ | ↓ | ↓ | ↓ |

| Cap (pF) | Available | Size | | | |
|----------|-----------|------|------|------|------|
| | Tolerance | MK02 | MK03 | MK05 | MK10 |
| 7.5 | B,C,J,K,M | 50V | 250V | 250V | 500V |
| 8.2 | ↓ | ↓ | ↓ | ↓ | ↓ |
| 9.1 | B,C,J,K,M | ↓ | ↓ | ↓ | ↓ |
| 10 | F,G,J,K,M | ↓ | ↓ | ↓ | ↓ |
| 11 | ↓ | ↓ | ↓ | ↓ | ↓ |
| 12 | ↓ | ↓ | ↓ | ↓ | ↓ |
| 13 | ↓ | ↓ | ↓ | ↓ | ↓ |
| 15 | ↓ | ↓ | ↓ | ↓ | ↓ |
| 18 | ↓ | ↓ | ↓ | ↓ | ↓ |
| 20 | ↓ | ↓ | ↓ | ↓ | ↓ |
| 22 | ↓ | ↓ | ↓ | ↓ | ↓ |
| 24 | ↓ | ↓ | ↓ | ↓ | ↓ |
| 27 | ↓ | ↓ | ↓ | ↓ | ↓ |
| 30 | ↓ | ↓ | ↓ | ↓ | ↓ |
| 33 | ↓ | ↓ | ↓ | ↓ | ↓ |
| 36 | ↓ | ↓ | ↓ | ↓ | ↓ |
| 39 | ↓ | ↓ | ↓ | ↓ | ↓ |
| 43 | ↓ | ↓ | ↓ | ↓ | ↓ |
| 47 | ↓ | ↓ | ↓ | ↓ | ↓ |
| 51 | ↓ | ↓ | ↓ | ↓ | ↓ |
| 56 | ↓ | ↓ | ↓ | ↓ | ↓ |
| 68 | ↓ | ↓ | ↓ | ↓ | ↓ |
| 75 | ↓ | ↓ | ↓ | ↓ | ↓ |
| 82 | ↓ | ↓ | ↓ | ↓ | ↓ |
| 91 | ↓ | ↓ | ↓ | ↓ | ↓ |

| Cap (pF) | Available | Size | | | |
|----------|-----------|------|------|------|------|
| | Tolerance | MK02 | MK03 | MK05 | MK10 |
| 100 | F,G,J,K,M | N/A | 100V | 250V | 500V |
| 110 | ↓ | ↓ | ↓ | ↓ | ↓ |
| 120 | ↓ | ↓ | ↓ | ↓ | ↓ |
| 130 | ↓ | ↓ | ↓ | ↓ | ↓ |
| 140 | ↓ | ↓ | ↓ | ↓ | ↓ |
| 150 | ↓ | ↓ | ↓ | ↓ | ↓ |
| 160 | ↓ | ↓ | ↓ | ↓ | ↓ |
| 180 | ↓ | ↓ | ↓ | ↓ | ↓ |
| 200 | ↓ | ↓ | ↓ | ↓ | ↓ |
| 220 | ↓ | ↓ | ↓ | ↓ | ↓ |
| 270 | ↓ | ↓ | ↓ | ↓ | ↓ |
| 300 | ↓ | ↓ | ↓ | ↓ | ↓ |
| 330 | ↓ | ↓ | ↓ | ↓ | ↓ |
| 360 | ↓ | ↓ | ↓ | ↓ | ↓ |
| 390 | ↓ | ↓ | ↓ | ↓ | ↓ |
| 430 | ↓ | ↓ | ↓ | ↓ | ↓ |
| 470 | ↓ | ↓ | ↓ | ↓ | ↓ |
| 510 | ↓ | ↓ | ↓ | ↓ | ↓ |
| 560 | ↓ | ↓ | ↓ | ↓ | ↓ |
| 620 | ↓ | ↓ | ↓ | ↓ | ↓ |
| 680 | ↓ | ↓ | ↓ | ↓ | ↓ |
| 750 | ↓ | ↓ | ↓ | ↓ | ↓ |
| 820 | ↓ | ↓ | ↓ | ↓ | ↓ |
| 910 | ↓ | ↓ | ↓ | ↓ | ↓ |
| 1000 | F,G,J,K,M | ↓ | ↓ | ↓ | ↓ |



MK Series Capacitors

Ultra Low ESR, C0G (NP0) Chip Capacitors

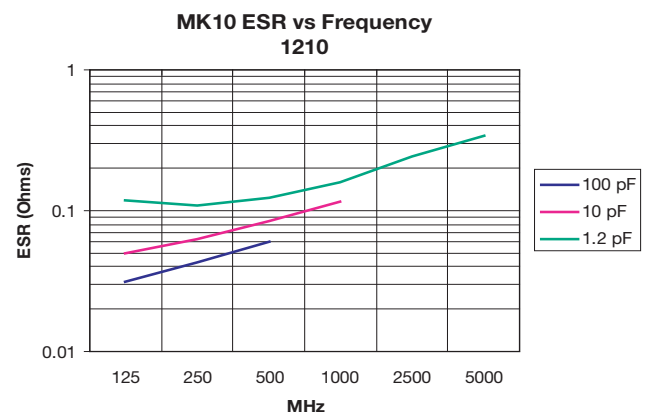
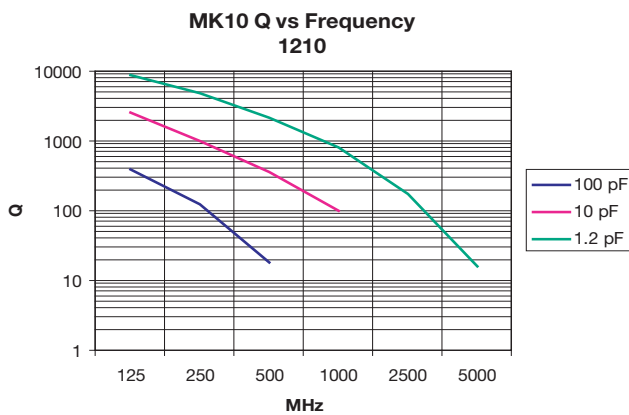
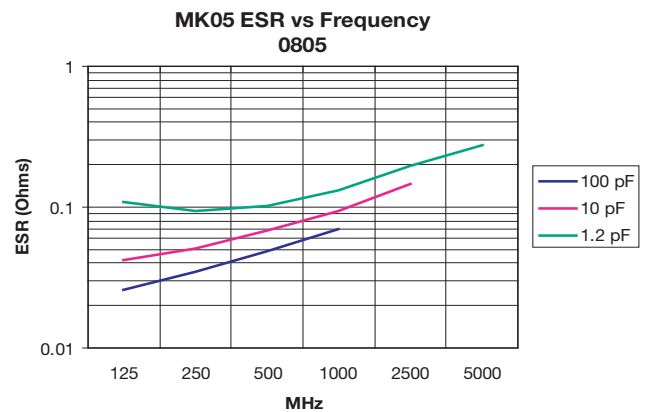
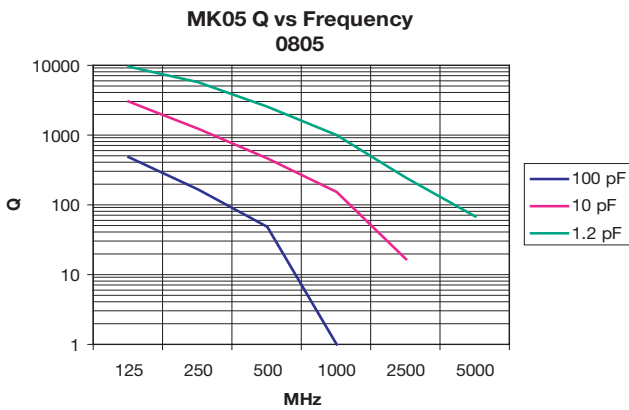
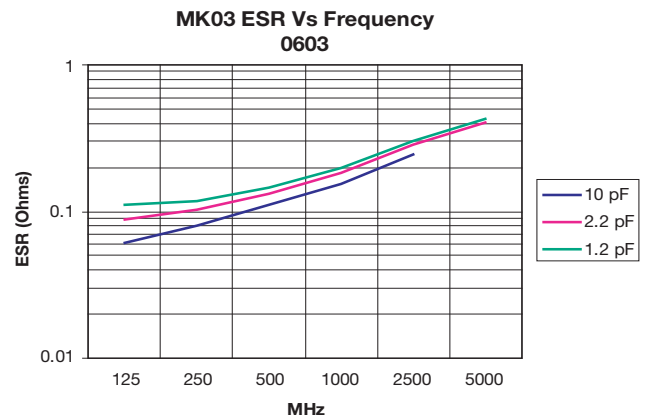
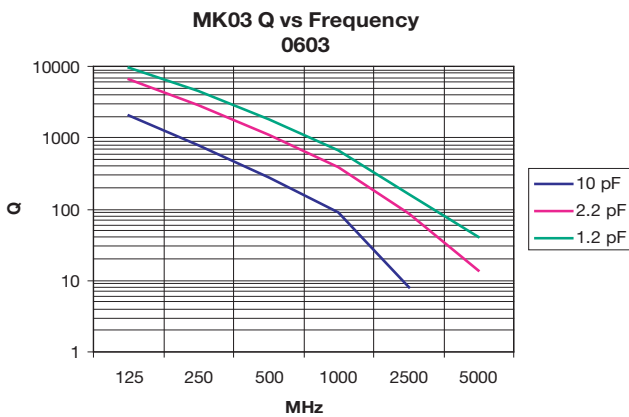
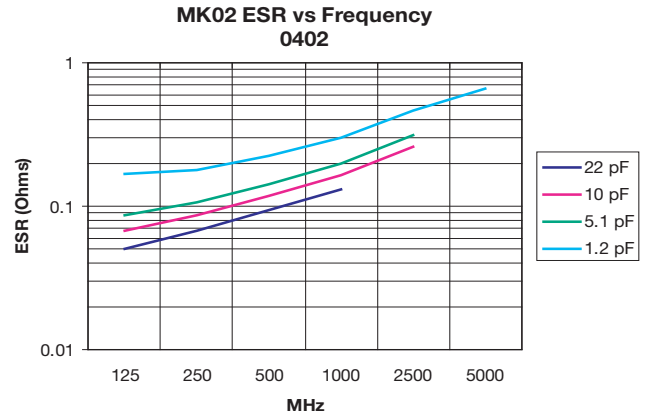
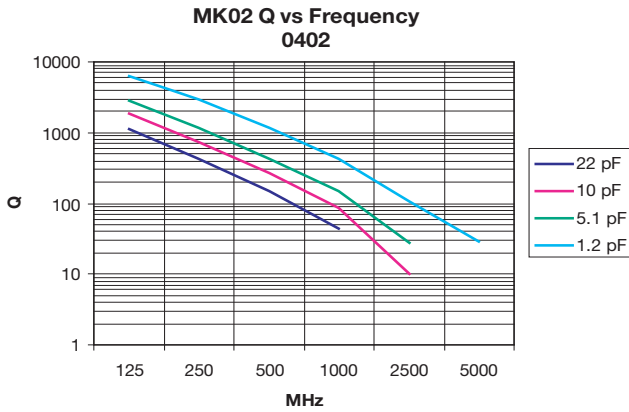

Microwave MLC's



AQ Series

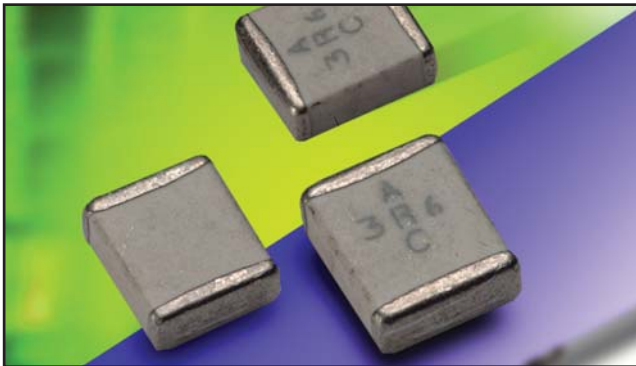

These porcelain and ceramic dielectric multilayer capacitor (MLC) chips are best suited for RF/ Microwave applications typically ranging from 10 MHz to 4.2 GHz. Characteristic is a fine grained, high density, high purity dielectric material impervious to moisture with heavy internal palladium electrodes.

These characteristics lend well to applications requiring:

- 1) high current carrying capabilities;
- 2) high quality factors;
- 3) very low equivalent series resistance;
- 4) very high series resonance;
- 5) excellent stability under stresses of changing voltage, frequency, time and temperature.

MECHANICAL DIMENSIONS: inches (millimeters)

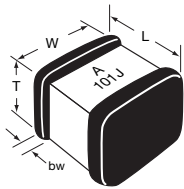

| Case | Length (L) | Width (W) | Thickness (T) | Band Width (bw) |
|------|---|--------------------------|--------------------------|---|
| AQ11 | .055±.015 (1.40±.381) | .055±.015 (1.40±.381) | .020/.057 (.508/1.45) | .010 + .010 -.005 (.254 +.254 -.127) |
| AQ12 | .055 + .015 - .010 (1.40+ .381 - .254) | .055±.015 (1.40±.381) | .020/.057 (.508/1.45) | .010 + .010 -.005 (.254 +.254 -.127) |
| AQ13 | .110±.020 (2.79±.508) | .110±.020 (2.79±.508) | .030/.102 (.762/2.59) | .015±.010 (.381±.254) |
| AQ14 | .110 + .020 - .010 (2.79 +.889 -.254) | .110±.010 (2.79±.508) | .030/.102 (.762/2.59) | .015±.010 (.381±.254) |

HOW TO ORDER

| | | | | | | | | |
|--|---|--|--|---|--|---|--|--|
| <p>AQ</p> <p>AVX Style AQ11, AQ12, AQ13, AQ14</p> | <p>11</p> <p>Case Size (See Chart)</p> | <p>E</p> <p>Voltage Code 5 = 50V 1 = 100V E = 150V 2 = 200V 9 = 300V 7 = 500V</p> | <p>M</p> <p>Temperature Coefficient Code M = +90±20ppm/°C (AQ11/12/13/14) A = 0±30ppm/°C (AQ11/12/13/14) C = 15% ("J" Termination only) (AQ12/14)</p> | <p>100</p> <p>Capacitance EIA Capacitance Code in pF. First two digits = significant figures or "R" for decimal place. Third digit = number of zeros or after "R" significant figures.</p> | <p>J</p> <p>Capacitance Tolerance Code B = ±.1 pF C = ±.25 pF D = ±.5 pF F = ±1% G = ±2% J = ±5% K = ±10% M = ±20% N = ±30%</p> | <p>A</p> <p>Failure Rate Code A = Not Applicable</p> | <p>1</p> <p>Termination Style Code 1 = Pd/Ag (AQ11/13 only) 7 = Ag/Ni/Au (AQ11/13 only) J = Nickel Barrier Sn/Pb (60/40) - (AQ12/14 only) T = 100% Tin (AQ12/14 only)</p> | <p>ME</p> <p>Packaging* Code 3A = 13" Reel Unmarked ME = 7" Reel Marked RE = 13" Reel Marked WE = Waffle Pack Marked BE = Bulk Marked</p> |
|--|---|--|--|---|--|---|--|--|

PACKAGING

Standard Packaging = Waffle Pack (maximum quantity is 80)

TAPE & REEL: All tape and reel specifications are in compliance with EIA RS481 (equivalent to IEC 286 part 3).

Sizes SQCA through SQCB, CDR11/12 through 13/14.

- 8mm carrier
- 7" reel: ≤0.040" thickness = 2000 pcs
 ≤0.075" thickness = 2000 pcs
- 13" reel: ≤0.075" thickness = 10,000 pcs

Not RoHS Compliant



For RoHS compliant products, please select correct termination style.



ELECTRICAL SPECIFICATIONS

| AQ11, AQ12, AQ13, AQ14 | | | |
|---------------------------------------|-------------------------|---|---|
| | | M & A | C |
| Temperature Coefficient (TCC) | | (M) +90 ± 20 PPM/°C (-55°C to +125°C) (M) +90 ± 30 PPM/°C (+125°C to +175°C) (A) 0 ± 30 PPM/°C | ±15% (-55°C to 125°C) |
| Capacitance Range | | (M) 0.1 pF to 1000 pF (A) 0.1 pF to 5100 pF | 0.001µF to 0.1µF |
| Operating Temperature | | 0.1 pF to 330 pF: from -55°C to +175°C 360 pF to 5100 pF: from -55°C to +125°C | -55°C to +125°C |
| Quality Factor (Q) | M Dielectric A & B Case | Greater than 10,000 at 1 MHz | 2.5% @ 1kHz |
| | A Dielectric B Case | Greater than 10,000 at 1 MHz Greater than 2,000 at 1 MHz Greater than 2,000 at 1 KHz | 0.1 - 200 pF 220 - 1000 pF 1100 - 5100 pF |
| | A Dielectric A Case | Greater than 10,000 at 1 MHz Greater than 2,000 at 1 MHz | 0.1 - 100 pF 110 - 1000 pF |
| Insulation Resistance (IR) | | 0.1 pF to 470 pF 10 ⁹ Megohms min. @ 25°C at rated WVDC 10 ⁹ Megohms min. @ 125°C at rated WVDC 510 pF to 5100 pF 10 ⁹ Megohms min. @ 25°C at rated WVDC 10 ⁹ Megohms min. @ 125°C at rated WVDC | 10 ⁴ Megohms min. @ 25°C at rated WVDC 10 ³ Megohms min. @ 125°C at rated WVDC |
| Working Voltage (WVDC) | | See Capacitance Values table | See Capacitance Values table |
| Dielectric Withstanding Voltage (DWW) | | 250% of rated WVDC for 5 secs (for 500V rated 150% of rated voltage) | 250% of rated WVDC for 5 secs |
| Aging Effects | | None | <3% per decade hour |
| Piezoelectric Effects | | None | None |
| Capacitance Drift | | ± (0.02% or 0.02 pF), whichever is greater | Not Applicable |

ENVIRONMENTAL CHARACTERISTICS

AVX SQLB will meet and exceed the requirements of EIA-198, MIL-PRF-55681 and MIL-PRF-123

| | |
|---------------------------|---|
| Thermal Shock | Mil-STD-202, Method 107, Condition A |
| Moisture Resistance | Mil-STD-202, Method 106 |
| Low Voltage Humidity | Mil-STD-202, Method 103, condition A, with 1.5 VDC applied while subjected to an environment of 85°C with 85% relative humidity for 240 hours |
| Life Test | Mil-STD-202, Method 108, for 2000 hours at 125°C |
| Shock | Mil-STD-202, Method 213, Condition J |
| Vibration | Mil-STD-202, Method 204, Condition B |
| Immersion | Mil-STD-202, Method 104, Condition B |
| Salt Spray | Mil-STD-202, Method 101, Condition B |
| Solderability | Mil-STD-202, Method 208 |
| Terminal Strength | Mil-STD-202, Method 211 |
| Temperature Cycling | Mil-STD-202, Method 102, Condition C |
| Barometric Pressure | Mil-STD-202, Method 105, Condition B |
| Resistance to Solder Heat | Mil-STD-202, Method 210, Condition C |

Microwave MLC's



AQ Series Available Capacitance/Size/WVDC/T.C.

TABLE I: TC: M (+90±20PPM/°C)

CASE SIZE 11, 12, 13 & 14

DIMENSIONS: inches (millimeters)

| Case | Length | Width | Thickness | Band Width | Avail. Term. |
|------|---------------------------------------|-----------------------|-----------------------|-------------------------------------|--------------|
| 11 | .055±.015 (1.40±.381) | .055±.015 (1.40±.381) | .020/.057 (.508/1.45) | .010 +.010 -.005 (.254 +.254 -.127) | 1 & 7 |
| 12 | .055±.025 (1.40±.635) | .055±.015 (1.40±.381) | .020/.057 (.508/1.45) | .010 +.010 -.005 (.254 +.254 -.127) | J |
| 13 | .110±.020 (2.79±.508) | .110±.020 (2.79±.508) | .030/.102 (.762/2.59) | .015±.010 (.381±.254) | 1 & 7 |
| 14 | .110 +0.035 -0.020 (2.79 +.889 -.508) | .110±.020 (2.79±.508) | .030/.102 (.762/2.59) | .015±.010 (.381±.254) | J |

| Case: AQ11, AQ12 | | |
|------------------|---------------|------|
| Cap. pF | Cap. Tol. | WVDC |
| 0.1 | B | 150 |
| 0.2 | B | 150 |
| 0.3 | B,C | 150 |
| 0.4 | B,C | 150 |
| 0.5 | B, C, D | 150 |
| 0.6 | B, C, D | 150 |
| 0.7 | B, C, D | 150 |
| 0.8 | B, C, D | 150 |
| 0.9 | B, C, D | 150 |
| 1.0 | B, C, D | 150 |
| 1.1 | B, C, D | 150 |
| 1.2 | B, C, D | 150 |
| 1.3 | B, C, D | 150 |
| 1.4 | B, C, D | 150 |
| 1.5 | B, C, D | 150 |
| 1.6 | B, C, D | 150 |
| 1.7 | B, C, D | 150 |
| 1.8 | B, C, D | 150 |
| 1.9 | B, C, D | 150 |
| 2.0 | B, C, D | 150 |
| 2.2 | B, C, D | 150 |
| 2.4 | B, C, D | 150 |
| 2.7 | B, C, D | 150 |
| 3.0 | B, C, D | 150 |
| 3.3 | B, C, D | 150 |
| 3.6 | B, C, D | 150 |
| 3.9 | B, C, D | 150 |
| 4.3 | B, C, D | 150 |
| 4.7 | B, C, D | 150 |
| 5.1 | B, C, D | 150 |
| 5.6 | B, C, D | 150 |
| 6.2 | B, C, D | 150 |
| 6.8 | B, C, J, K, M | 150 |
| 7.5 | B, C, J, K, M | 150 |
| 8.2 | B, C, J, K, M | 150 |
| 9.1 | B, C, J, K, M | 150 |
| 10 | F, G, J, K, M | 150 |
| 11 | F, G, J, K, M | 150 |
| 12 | F, G, J, K, M | 150 |
| 13 | F, G, J, K, M | 150 |
| 15 | F, G, J, K, M | 150 |
| 16 | F, G, J, K, M | 150 |
| 18 | F, G, J, K, M | 150 |
| 20 | F, G, J, K, M | 150 |
| 22 | F, G, J, K, M | 150 |
| 24 | F, G, J, K, M | 150 |
| 27 | F, G, J, K, M | 150 |
| 30 | F, G, J, K, M | 150 |
| 33 | F, G, J, K, M | 150 |
| 36 | F, G, J, K, M | 150 |
| 39 | F, G, J, K, M | 150 |
| 43 | F, G, J, K, M | 150 |
| 47 | F, G, J, K, M | 150 |
| 51 | F, G, J, K, M | 150 |
| 56 | F, G, J, K, M | 150 |
| 62 | F, G, J, K, M | 150 |
| 68 | F, G, J, K, M | 150 |
| 75 | F, G, J, K, M | 150 |
| 82 | F, G, J, K, M | 150 |
| 91 | F, G, J, K, M | 150 |
| 100 | F, G, J, K, M | 150 |

| Case: AQ13, AQ14 | | |
|------------------|---------------|------|
| Cap. pF | Cap. Tol. | WVDC |
| 0.1 | B | 500 |
| 0.2 | B | 500 |
| 0.3 | B,C | 500 |
| 0.4 | B,C | 500 |
| 0.5 | B, C, D | 500 |
| 0.6 | B, C, D | 500 |
| 0.7 | B, C, D | 500 |
| 0.8 | B, C, D | 500 |
| 0.9 | B, C, D | 500 |
| 1.0 | B, C, D | 500 |
| 1.1 | B, C, D | 500 |
| 1.2 | B, C, D | 500 |
| 1.3 | B, C, D | 500 |
| 1.4 | B, C, D | 500 |
| 1.5 | B, C, D | 500 |
| 1.6 | B, C, D | 500 |
| 1.7 | B, C, D | 500 |
| 1.8 | B, C, D | 500 |
| 1.9 | B, C, D | 500 |
| 2.0 | B, C, D | 500 |
| 2.2 | B, C, D | 500 |
| 2.4 | B, C, D | 500 |
| 2.7 | B, C, D | 500 |
| 3.0 | B, C, D | 500 |
| 3.3 | B, C, D | 500 |
| 3.6 | B, C, D | 500 |
| 3.9 | B, C, D | 500 |
| 4.3 | B, C, D | 500 |
| 4.7 | B, C, D | 500 |
| 5.1 | B, C, D | 500 |
| 5.6 | B, C, D | 500 |
| 6.2 | B, C, D | 500 |
| 6.8 | B, C, J, K, M | 500 |
| 7.5 | B, C, J, K, M | 500 |
| 8.2 | B, C, J, K, M | 500 |
| 9.1 | B, C, J, K, M | 500 |
| 10 | F, G, J, K, M | 500 |
| 11 | F, G, J, K, M | 500 |
| 12 | F, G, J, K, M | 500 |
| 13 | F, G, J, K, M | 500 |
| 15 | F, G, J, K, M | 500 |
| 16 | F, G, J, K, M | 500 |
| 18 | F, G, J, K, M | 500 |
| 20 | F, G, J, K, M | 500 |
| 22 | F, G, J, K, M | 500 |
| 24 | F, G, J, K, M | 500 |
| 27 | F, G, J, K, M | 500 |
| 30 | F, G, J, K, M | 500 |
| 33 | F, G, J, K, M | 500 |
| 36 | F, G, J, K, M | 500 |
| 39 | F, G, J, K, M | 500 |
| 43 | F, G, J, K, M | 500 |
| 47 | F, G, J, K, M | 500 |
| 51 | F, G, J, K, M | 500 |
| 56 | F, G, J, K, M | 500 |
| 62 | F, G, J, K, M | 500 |
| 68 | F, G, J, K, M | 500 |
| 75 | F, G, J, K, M | 500 |
| 82 | F, G, J, K, M | 500 |
| 91 | F, G, J, K, M | 500 |

| Cap. pF | Cap. Tol. | WVDC |
|---------|---------------|------|
| 100 | F, G, J, K, M | 500 |
| 110 | F, G, J, K, M | 300 |
| 120 | F, G, J, K, M | 300 |
| 130 | F, G, J, K, M | 300 |
| 150 | F, G, J, K, M | 300 |
| 160 | F, G, J, K, M | 300 |
| 180 | F, G, J, K, M | 300 |
| 200 | F, G, J, K, M | 300 |
| 220 | F, G, J, K, M | 200 |
| 240 | F, G, J, K, M | 200 |
| 270 | F, G, J, K, M | 200 |
| 300 | F, G, J, K, M | 200 |
| 330 | F, G, J, K, M | 200 |
| 360 | F, G, J, K, M | 200 |
| 390 | F, G, J, K, M | 200 |
| 430 | F, G, J, K, M | 200 |
| 470 | F, G, J, K, M | 200 |
| 510 | F, G, J, K, M | 150 |
| 560 | F, G, J, K, M | 150 |
| 620 | F, G, J, K, M | 150 |
| 680 | F, G, J, K, M | 150 |
| 750 | F, G, J, K, M | 150 |
| 820 | F, G, J, K, M | 150 |
| 910 | F, G, J, K, M | 150 |
| 1000 | F, G, J, K, M | 150 |



Microwave MLC's



AQ Series Available Capacitance/Size/WVDC/T.C.

**TABLE II: TC: A (0±30PPM/°C)
CASE SIZE 11, 12, 13 & 14**

DIMENSIONS: inches (millimeters)

| Case | Length | Width | Thickness | Band Width | Avail. Term. |
|------|---------------------------------------|-----------------------|-----------------------|-------------------------------------|--------------|
| 11 | .055±.015 (1.40±.381) | .055±.015 (1.40±.381) | .020/.057 (.508/1.45) | .010 +.010 -.005 (.254 +.254 -.127) | 1 & 7 |
| 12 | .055±.025 (1.40±.635) | .055±.015 (1.40±.381) | .020/.057 (.508/1.45) | .010 +.010 -.005 (.254 +.254 -.127) | J |
| 13 | .110±.020 (2.79±.508) | .110±.020 (2.79±.508) | .030/.102 (.762/2.59) | .015±.010 (.381±.254) | 1 & 7 |
| 14 | .110 +0.035 -0.020 (2.79 +.889 -.508) | .110±.020 (2.79±.508) | .030/.102 (.762/2.59) | .015±.010 (.381±.254) | J |

| Case: AQ11, AQ12 | | | | | |
|------------------|---------------|------|---------|---------------|------|
| Cap. pF | Cap. Tol. | WVDC | Cap. pF | Cap. Tol. | WVDC |
| 0.1 | B | 150 | 24 | F, G, J, K, M | 150 |
| 0.2 | B | 150 | 27 | F, G, J, K, M | 150 |
| 0.3 | B,C | 150 | 30 | F, G, J, K, M | 150 |
| 0.4 | B,C | 150 | 33 | F, G, J, K, M | 150 |
| 0.5 | B, C, D | 150 | 36 | F, G, J, K, M | 150 |
| 0.6 | B, C, D | 150 | 39 | F, G, J, K, M | 150 |
| 0.7 | B, C, D | 150 | 43 | F, G, J, K, M | 150 |
| 0.8 | B, C, D | 150 | 47 | F, G, J, K, M | 150 |
| 0.9 | B, C, D | 150 | 51 | F, G, J, K, M | 150 |
| 1.0 | B, C, D | 150 | 56 | F, G, J, K, M | 150 |
| 1.1 | B, C, D | 150 | 62 | F, G, J, K, M | 150 |
| 1.2 | B, C, D | 150 | 68 | F, G, J, K, M | 150 |
| 1.3 | B, C, D | 150 | 75 | F, G, J, K, M | 150 |
| 1.4 | B, C, D | 150 | 82 | F, G, J, K, M | 150 |
| 1.5 | B, C, D | 150 | 91 | F, G, J, K, M | 150 |
| 1.6 | B, C, D | 150 | 100 | F, G, J, K, M | 150 |
| 1.7 | B, C, D | 150 | 110 | F, G, J, K, M | 50 |
| 1.8 | B, C, D | 150 | 120 | F, G, J, K, M | 50 |
| 1.9 | B, C, D | 150 | 130 | F, G, J, K, M | 50 |
| 2.0 | B, C, D | 150 | 150 | F, G, J, K, M | 50 |
| 2.2 | B, C, D | 150 | 160 | F, G, J, K, M | 50 |
| 2.4 | B, C, D | 150 | 180 | F, G, J, K, M | 50 |
| 2.7 | B, C, D | 150 | 200 | F, G, J, K, M | 50 |
| 3.0 | B, C, D | 150 | 220 | F, G, J, K, M | 50 |
| 3.3 | B, C, D | 150 | 240 | F, G, J, K, M | 50 |
| 3.6 | B, C, D | 150 | 270 | F, G, J, K, M | 50 |
| 3.9 | B, C, D | 150 | 300 | F, G, J, K, M | 50 |
| 4.3 | B, C, D | 150 | 330 | F, G, J, K, M | 50 |
| 4.7 | B, C, D | 150 | 360 | F, G, J, K, M | 50 |
| 5.1 | B, C, D | 150 | 390 | F, G, J, K, M | 50 |
| 5.6 | B, C, D | 150 | 430 | F, G, J, K, M | 50 |
| 6.2 | B, C, D | 150 | 470 | F, G, J, K, M | 50 |
| 6.8 | B, C, J, K, M | 150 | 510 | F, G, J, K, M | 50 |
| 7.5 | B, C, J, K, M | 150 | 560 | F, G, J, K, M | 50 |
| 8.2 | B, C, J, K, M | 150 | 620 | F, G, J, K, M | 50 |
| 9.1 | B, C, J, K, M | 150 | 680 | F, G, J, K, M | 50 |
| 10 | F, G, J, K, M | 150 | 750 | F, G, J, K, M | 50 |
| 11 | F, G, J, K, M | 150 | 820 | F, G, J, K, M | 50 |
| 12 | F, G, J, K, M | 150 | 910 | F, G, J, K, M | 50 |
| 13 | F, G, J, K, M | 150 | 1000 | F, G, J, K, M | 50 |
| 15 | F, G, J, K, M | 150 | | | |
| 16 | F, G, J, K, M | 150 | | | |
| 18 | F, G, J, K, M | 150 | | | |
| 20 | F, G, J, K, M | 150 | | | |
| 22 | F, G, J, K, M | 150 | | | |

| Case: AQ13, AQ14 | | | | | |
|------------------|---------------|------|---------|---------------|------|
| Cap. pF | Cap. Tol. | WVDC | Cap. pF | Cap. Tol. | WVDC |
| 0.1 | B | 500 | 51 | F, G, J, K, M | 500 |
| 0.2 | B | 500 | 56 | F, G, J, K, M | 500 |
| 0.3 | B,C | 500 | 62 | F, G, J, K, M | 500 |
| 0.4 | B,C | 500 | 68 | F, G, J, K, M | 500 |
| 0.5 | B, C, D | 500 | 75 | F, G, J, K, M | 500 |
| 0.6 | B, C, D | 500 | 82 | F, G, J, K, M | 500 |
| 0.7 | B, C, D | 500 | 91 | F, G, J, K, M | 500 |
| 0.8 | B, C, D | 500 | 100 | F, G, J, K, M | 500 |
| 0.9 | B, C, D | 500 | 110 | F, G, J, K, M | 300 |
| 1.0 | B, C, D | 500 | 120 | F, G, J, K, M | 300 |
| 1.1 | B, C, D | 500 | 130 | F, G, J, K, M | 300 |
| 1.2 | B, C, D | 500 | 150 | F, G, J, K, M | 300 |
| 1.3 | B, C, D | 500 | 160 | F, G, J, K, M | 300 |
| 1.4 | B, C, D | 500 | 180 | F, G, J, K, M | 300 |
| 1.5 | B, C, D | 500 | 200 | F, G, J, K, M | 300 |
| 1.6 | B, C, D | 500 | 220 | F, G, J, K, M | 200 |
| 1.7 | B, C, D | 500 | 240 | F, G, J, K, M | 200 |
| 1.8 | B, C, D | 500 | 270 | F, G, J, K, M | 200 |
| 1.9 | B, C, D | 500 | 300 | F, G, J, K, M | 200 |
| 2.0 | B, C, D | 500 | 330 | F, G, J, K, M | 200 |
| 2.2 | B, C, D | 500 | 360 | F, G, J, K, M | 200 |
| 2.4 | B, C, D | 500 | 390 | F, G, J, K, M | 200 |
| 2.7 | B, C, D | 500 | 430 | F, G, J, K, M | 200 |
| 3.0 | B, C, D | 500 | 470 | F, G, J, K, M | 200 |
| 3.3 | B, C, D | 500 | 510 | F, G, J, K, M | 150 |
| 3.6 | B, C, D | 500 | 560 | F, G, J, K, M | 150 |
| 3.9 | B, C, D | 500 | 620 | F, G, J, K, M | 150 |
| 4.3 | B, C, D | 500 | 680 | F, G, J, K, M | 150 |
| 4.7 | B, C, D | 500 | 750 | F, G, J, K, M | 150 |
| 5.1 | B, C, D | 500 | 820 | F, G, J, K, M | 150 |
| 5.6 | B, C, D | 500 | 910 | F, G, J, K, M | 150 |
| 6.2 | B, C, D | 500 | 1000 | F, G, J, K, M | 150 |
| 6.8 | B, C, J, K, M | 500 | 1100 | F, G, J, K, M | 50 |
| 7.5 | B, C, J, K, M | 500 | 1200 | F, G, J, K, M | 50 |
| 8.2 | B, C, J, K, M | 500 | 1300 | F, G, J, K, M | 50 |
| 9.1 | B, C, J, K, M | 500 | 1500 | F, G, J, K, M | 50 |
| 10 | F, G, J, K, M | 500 | 1600 | F, G, J, K, M | 50 |
| 11 | F, G, J, K, M | 500 | 1800 | F, G, J, K, M | 50 |
| 12 | F, G, J, K, M | 500 | 2000 | F, G, J, K, M | 50 |
| 13 | F, G, J, K, M | 500 | 2200 | F, G, J, K, M | 50 |
| 15 | F, G, J, K, M | 500 | 2400 | F, G, J, K, M | 50 |
| 16 | F, G, J, K, M | 500 | 2700 | F, G, J, K, M | 50 |
| 18 | F, G, J, K, M | 500 | 3000 | F, G, J, K, M | 50 |
| 20 | F, G, J, K, M | 500 | 3300 | F, G, J, K, M | 50 |
| 22 | F, G, J, K, M | 500 | 3600 | F, G, J, K, M | 50 |
| 24 | F, G, J, K, M | 500 | 3900 | F, G, J, K, M | 50 |
| 27 | F, G, J, K, M | 500 | 4300 | F, G, J, K, M | 50 |
| 30 | F, G, J, K, M | 500 | 4700 | F, G, J, K, M | 50 |
| 33 | F, G, J, K, M | 500 | 5000 | F, G, J, K, M | 50 |
| 36 | F, G, J, K, M | 500 | 5100 | F, G, J, K, M | 50 |
| 39 | F, G, J, K, M | 500 | | | |
| 43 | F, G, J, K, M | 500 | | | |
| 47 | F, G, J, K, M | 500 | | | |

TABLE III: TC: C (±15%) CASE SIZE 12 & 14

| Case: AQ12 | | | | | | | | | Case: AQ14 | | | | | | | | |
|------------|-----------|------|---------|-----------|------|---------|-----------|------|------------|-----------|------|---------|-----------|------|---------|-----------|------|
| Cap. pF | Cap. Tol. | WVDC | Cap. pF | Cap. Tol. | WVDC | Cap. pF | Cap. Tol. | WVDC | Cap. pF | Cap. Tol. | WVDC | Cap. pF | Cap. Tol. | WVDC | Cap. pF | Cap. Tol. | WVDC |
| 1000 | K, M, N | 50 | 2200 | K, M, N | 50 | 5100 | K, M, N | 50 | 5000 | K, M, N | 50 | 15000 | K, M, N | 50 | 47000 | K, M, N | 50 |
| 1200 | K, M, N | 50 | 2700 | K, M, N | 50 | 5600 | K, M, N | 50 | 6800 | K, M, N | 50 | 18000 | K, M, N | 50 | 68000 | K, M, N | 50 |
| 1500 | K, M, N | 50 | 3300 | K, M, N | 50 | 6800 | K, M, N | 50 | 8200 | K, M, N | 50 | 27000 | K, M, N | 50 | 82000 | K, M, N | 50 |
| 1800 | K, M, N | 50 | 3900 | K, M, N | 50 | 8200 | K, M, N | 50 | 10000 | K, M, N | 50 | 33000 | K, M, N | 50 | 100000 | K, M, N | 50 |
| 2000 | K, M, N | 50 | 4700 | K, M, N | 50 | 10000 | K, M, N | 50 | 12000 | K, M, N | 50 | 39000 | K, M, N | 50 | | | |



Microwave MLC's



CDR Series — MIL-PRF-55681 (RF/Microwave Chips)

MILITARY DESIGNATION PER MIL-PRF-55681

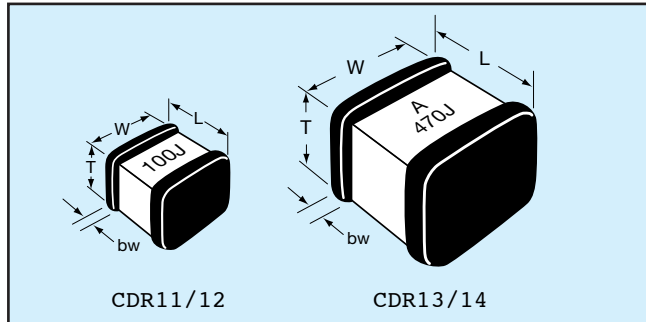

CROSS REFERENCE: AVX/MIL-PRF-55681

| Per MIL-C-55681 | AVX Style | Length (L) | Width (W) | Thickness (T) | | Termination Band (bw) | |
|-----------------|-----------|---|--------------------------|----------------|----------------|-----------------------|----------------|
| | | | | Max | Min | Max | Min |
| CDR11 | AQ11 | .055±.015 (1.40±.381) | .055±.015 (1.40±.381) | .057 (1.45) | .020 (.508) | .020 (.508) | .005 (.127) |
| CDR12 | AQ12 | .055±.025 (1.40±.635) | .055±.015 (1.40±.381) | .057 (1.45) | .020 (.508) | .020 (.508) | .005 (.127) |
| CDR13 | AQ13 | .110±.020 (2.79±.508) | .110±.020 (2.79±.508) | .102 (2.59) | .030 (.762) | .025 (.635) | .005 (.127) |
| CDR14 | AQ14 | .110 +.035 -0.020 (2.79 +.889 -.508) | .110±.020 (2.79±.508) | .102 (2.59) | .030 (.762) | .025 (.635) | .005 (.127) |

HOW TO ORDER

CDR12

MIL Style
CDR11, CDR12,
CDR13, CDR14

BG

Voltage Temperature Limits

BG = +90±20 ppm/°C with and without rated voltage from -55°C to +125°C
BP = 0±30ppm/°C with and without rated voltage from -55°C to +125°C

101

Capacitance

EIA Capacitance Code in pF.
First two digits = significant figures or "R" for decimal place.
Third digit = number of zeros or after "R" significant figures.

A

Rated Voltage Code

A = 50V
B = 100V
C = 200V
D = 300V
E = 500V

K

Capacitance Tolerance Code

B = ±.1 pF
C = ±.25 pF
D = ±.5 pF
F = ±1%
G = ±2%
J = ±5%
K = ±10%
M = ±20%

U

Termination Finish (Military Designations) Code

M = Palladium silver
N = Silver-nickel-gold
S = Solder coated final with a minimum of 4 percent lead
T = Silver
U = Base metallization-barrier metal-solder coated (tin/lead alloy, with a minimum of 4 percent lead)
W = Base metallization-barrier metal-tinned (tin or tin/lead alloy)
Y = Base metallization-barrier metal-tin (100 percent)
Z = Base metallization-barrier metal-tinned (tin/lead alloy, with a minimum of 4 percent lead)
*See MIL-PRF-55681 Specification for more details

S

Failure Rate Level

M = 1.0%
P = .1%
R = .01%
S = .001%

PACKAGING

Standard Packaging Quantity

CDR11-12 = 100 pcs per waffle pack

CDR13-14 = 80 pcs per waffle pack

TAPE & REEL: All tape and reel specifications are in compliance with EIA RS481 (equivalent to IEC 286 part 3).

Sizes SQCA through SQCB, CDR11/12 through 13/14.

—8mm carrier

—7" reel: ≤0.040" thickness = 2000 pcs

≤0.075" thickness = 2000 pcs

—13" reel: ≤0.075" thickness = 10,000 pcs

Not RoHS Compliant



For RoHS compliant products, please select correct termination style.



Microwave MLC's



CDR Series — MIL-PRF-55681 (RF/Microwave Chips)

TABLE I: STYLES CDR11 AND CDR12 CAPACITOR CHARACTERISTICS

| Type Designation 1/ | Capacitance in pF | Capacitance tolerance | Rated temperature and V/Temperature | WVDC | Type Designation 1/ | Capacitance in pF | Capacitance tolerance | Rated temperature and V/Temperature | WVDC |
|---------------------|-------------------|-----------------------|-------------------------------------|------|---------------------|-------------------|-----------------------|-------------------------------------|------|
| CDR1 -B-0R1AB-- | 0.1 | B | BG, BP | 50 | CDR1 -B-300A-- | 30 | F, G, J, K, M | BG, BP | 50 |
| CDR1 -B-0R2AB-- | 0.2 | B | BG, BP | 50 | CDR1 -B-330A-- | 33 | F, G, J, K, M | BG, BP | 50 |
| CDR1 -B-0R3A--- | 0.3 | B, C | BG, BP | 50 | CDR1 -B-360A-- | 36 | F, G, J, K, M | BG, BP | 50 |
| CDR1 -B-0R4A--- | 0.4 | B, C | BG, BP | 50 | CDR1 -B-390A-- | 39 | F, G, J, K, M | BG, BP | 50 |
| CDR1 -B-0R5A--- | 0.5 | B, C, D | BG, BP | 50 | CDR1 -B-430A-- | 43 | F, G, J, K, M | BG, BP | 50 |
| CDR1 -B-0R6A--- | 0.6 | B, C, D | BG, BP | 50 | CDR1 -B-470A-- | 47 | F, G, J, K, M | BG, BP | 50 |
| CDR1 -B-0R7A--- | 0.7 | B, C, D | BG, BP | 50 | CDR1 -B-510A-- | 51 | F, G, J, K, M | BG, BP | 50 |
| CDR1 -B-0R8A--- | 0.8 | B, C, D | BG, BP | 50 | CDR1 -B-560A-- | 56 | F, G, J, K, M | BG, BP | 50 |
| CDR1 -B-0R9A--- | 0.9 | B, C, D | BG, BP | 50 | CDR1 -B-620A-- | 62 | F, G, J, K, M | BG, BP | 50 |
| CDR1 -B-1R0A--- | 1.0 | B, C, D | BG, BP | 50 | CDR1 -B-680A-- | 68 | F, G, J, K, M | BG, BP | 50 |
| CDR1 -B-1R1A--- | 1.1 | B, C, D | BG, BP | 50 | CDR1 -B-750A-- | 75 | F, G, J, K, M | BG, BP | 50 |
| CDR1 -B-1R2A--- | 1.2 | B, C, D | BG, BP | 50 | CDR1 -B-820A-- | 82 | F, G, J, K, M | BG, BP | 50 |
| CDR1 -B-1R3A--- | 1.3 | B, C, D | BG, BP | 50 | CDR1 -B-910A-- | 91 | F, G, J, K, M | BG, BP | 50 |
| CDR1 -B-1R4A--- | 1.4 | B, C, D | BG, BP | 50 | CDR1 -B-101A-- | 100 | F, G, J, K, M | BG, BP | 50 |
| CDR1 -B-1R5A--- | 1.5 | B, C, D | BG, BP | 50 | CDR1 -B-111A-- | 110 | F, G, J, K, M | BP | 50 |
| CDR1 -B-1R6A--- | 1.6 | B, C, D | BG, BP | 50 | CDR1 -B-121A-- | 120 | F, G, J, K, M | BP | 50 |
| CDR1 -B-1R7A--- | 1.7 | B, C, D | BG, BP | 50 | CDR1 -B-131A-- | 130 | F, G, J, K, M | BP | 50 |
| CDR1 -B-1R8A--- | 1.8 | B, C, D | BG, BP | 50 | CDR1 -B-151A-- | 150 | F, G, J, K, M | BP | 50 |
| CDR1 -B-1R9A--- | 1.9 | B, C, D | BG, BP | 50 | CDR1 -B-161A-- | 160 | F, G, J, K, M | BP | 50 |
| CDR1 -B-2R0A--- | 2.0 | B, C, D | BG, BP | 50 | CDR1 -B-181A-- | 180 | F, G, J, K, M | BP | 50 |
| CDR1 -B-2R1A--- | 2.1 | B, C, D | BG, BP | 50 | CDR1 -B-201A-- | 200 | F, G, J, K, M | BP | 50 |
| CDR1 -B-2R2A--- | 2.2 | B, C, D | BG, BP | 50 | CDR1 -B-221A-- | 220 | F, G, J, K, M | BP | 50 |
| CDR1 -B-2R4A--- | 2.4 | B, C, D | BG, BP | 50 | CDR1 -B-241A-- | 240 | F, G, J, K, M | BP | 50 |
| CDR1 -B-2R7A--- | 2.7 | B, C, D | BG, BP | 50 | CDR1 -B-271A-- | 270 | F, G, J, K, M | BP | 50 |
| CDR1 -B-3R0A--- | 3.0 | B, C, D | BG, BP | 50 | CDR1 -B-301A-- | 300 | F, G, J, K, M | BP | 50 |
| CDR1 -B-3R3A--- | 3.3 | B, C, D | BG, BP | 50 | CDR1 -B-331A-- | 330 | F, G, J, K, M | BP | 50 |
| CDR1 -B-3R6A--- | 3.6 | B, C, D | BG, BP | 50 | CDR1 -B-361A-- | 360 | F, G, J, K, M | BP | 50 |
| CDR1 -B-3R9A--- | 3.9 | B, C, D | BG, BP | 50 | CDR1 -B-391A-- | 390 | F, G, J, K, M | BP | 50 |
| CDR1 -B-4R3A--- | 4.3 | B, C, D | BG, BP | 50 | CDR1 -B-431A-- | 430 | F, G, J, K, M | BP | 50 |
| CDR1 -B-4R7A--- | 4.7 | B, C, D | BG, BP | 50 | CDR1 -B-471A-- | 470 | F, G, J, K, M | BP | 50 |
| CDR1 -B-5R1A--- | 5.1 | B, C, D | BG, BP | 50 | CDR1 -B-511A-- | 510 | F, G, J, K, M | BP | 50 |
| CDR1 -B-5R6A--- | 5.6 | B, C, D | BG, BP | 50 | CDR1 -B-561A-- | 560 | F, G, J, K, M | BP | 50 |
| CDR1 -B-6R2A--- | 6.2 | B, C, D | BG, BP | 50 | CDR1 -B-621A-- | 620 | F, G, J, K, M | BP | 50 |
| CDR1 -B-6R8A--- | 6.8 | B, C, J, K, M | BG, BP | 50 | CDR1 -B-681A-- | 680 | F, G, J, K, M | BP | 50 |
| CDR1 -B-7R5A--- | 7.5 | B, C, J, K, M | BG, BP | 50 | CDR1 -B-751A-- | 750 | F, G, J, K, M | BP | 50 |
| CDR1 -B-8R2A--- | 8.2 | B, C, J, K, M | BG, BP | 50 | CDR1 -B-821A-- | 820 | F, G, J, K, M | BP | 50 |
| CDR1 -B-9R1A--- | 9.1 | B, C, J, K, M | BG, BP | 50 | CDR1 -B-911A-- | 910 | F, G, J, K, M | BP | 50 |
| CDR1 -B-100A-- | 10 | F, G, J, K, M | BG, BP | 50 | CDR1 -B-102A-- | 1000 | F, G, J, K, M | BP | 50 |
| CDR1 -B-110A-- | 11 | F, G, J, K, M | BG, BP | 50 | | | | | |
| CDR1 -B-120A-- | 12 | F, G, J, K, M | BG, BP | 50 | | | | | |
| CDR1 -B-130A-- | 13 | F, G, J, K, M | BG, BP | 50 | | | | | |
| CDR1 -B-150A-- | 15 | F, G, J, K, M | BG, BP | 50 | | | | | |
| CDR1 -B-160A-- | 16 | F, G, J, K, M | BG, BP | 50 | | | | | |
| CDR1 -B-180A-- | 18 | F, G, J, K, M | BG, BP | 50 | | | | | |
| CDR1 -B-200A-- | 20 | F, G, J, K, M | BG, BP | 50 | | | | | |
| CDR1 -B-220A-- | 22 | F, G, J, K, M | BG, BP | 50 | | | | | |
| CDR1 -B-240A-- | 24 | F, G, J, K, M | BG, BP | 50 | | | | | |
| CDR1 -B-270A-- | 27 | F, G, J, K, M | BG, BP | 50 | | | | | |

1/Complete type designation will include additional symbols to indicate style, voltage-temperature limits, capacitance tolerance (where applicable), termination finish ("M" or "N" for style CDR11, and "S", "U", "W", "Y" or "Z" for style CDR12) and failure rate level.

Microwave MLC's

CDR Series — MIL-PRF-55681 (RF/Microwave Chips)



TABLE II: STYLES CDR13 AND CDR14 CAPACITOR CHARACTERISTICS

| Type Designation 1/ | Capacitance in pF | Capacitance tolerance | Rated temperature and V/Temperature | WVDC | Type Designation 1/ | Capacitance in pF | Capacitance tolerance | Rated temperature and V/Temperature | WVDC |
|---------------------|-------------------|-----------------------|-------------------------------------|---------|---------------------|-------------------|-----------------------|-------------------------------------|---------|
| CDR1 -B-0R1*B-- | 0.1 | B | BG, BP | 200/500 | CDR1 -B-560*-- | 56 | F, G, J, K, M | BG, BP | 200/500 |
| CDR1 -B-0R2*B-- | 0.2 | B | BG, BP | 200/500 | CDR1 -B-620*-- | 62 | F, G, J, K, M | BG, BP | 200/500 |
| CDR1 -B-0R3*-- | 0.3 | B, C | BG, BP | 200/500 | CDR1 -B-680*-- | 68 | F, G, J, K, M | BG, BP | 200/500 |
| CDR1 -B-0R4*-- | 0.4 | B, C | BG, BP | 200/500 | CDR1 -B-750*-- | 75 | F, G, J, K, M | BG, BP | 200/500 |
| CDR1 -B-0R5*-- | 0.5 | B, C, D | BG, BP | 200/500 | CDR1 -B-820*-- | 82 | F, G, J, K, M | BG, BP | 200/500 |
| CDR1 -B-0R6*-- | 0.6 | B, C, D | BG, BP | 200/500 | CDR1 -B-910*-- | 91 | F, G, J, K, M | BG, BP | 200/500 |
| CDR1 -B-0R7*-- | 0.7 | B, C, D | BG, BP | 200/500 | CDR1 -B-101*-- | 100 | F, G, J, K, M | BG, BP | 200/500 |
| CDR1 -B-0R8*-- | 0.8 | B, C, D | BG, BP | 200/500 | CDR1 -B-111‡-- | 110 | F, G, J, K, M | BG, BP | 200/300 |
| CDR1 -B-0R9*-- | 0.9 | B, C, D | BG, BP | 200/500 | CDR1 -B-121‡-- | 120 | F, G, J, K, M | BG, BP | 200/300 |
| CDR1 -B-1R0*-- | 1.0 | B, C, D | BG, BP | 200/500 | CDR1 -B-131‡-- | 130 | F, G, J, K, M | BG, BP | 200/300 |
| CDR1 -B-1R1*-- | 1.1 | B, C, D | BG, BP | 200/500 | CDR1 -B-151‡-- | 150 | F, G, J, K, M | BG, BP | 200/300 |
| CDR1 -B-1R2*-- | 1.2 | B, C, D | BG, BP | 200/500 | CDR1 -B-161‡-- | 160 | F, G, J, K, M | BG, BP | 200/300 |
| CDR1 -B-1R3*-- | 1.3 | B, C, D | BG, BP | 200/500 | CDR1 -B-181‡-- | 180 | F, G, J, K, M | BG, BP | 200/300 |
| CDR1 -B-1R4*-- | 1.4 | B, C, D | BG, BP | 200/500 | CDR1 -B-201‡-- | 200 | F, G, J, K, M | BG, BP | 200/300 |
| CDR1 -B-1R5*-- | 1.5 | B, C, D | BG, BP | 200/500 | CDR1 -B-221C-- | 220 | F, G, J, K, M | BG, BP | 200 |
| CDR1 -B-1R6*-- | 1.6 | B, C, D | BG, BP | 200/500 | CDR1 -B-241C-- | 240 | F, G, J, K, M | BG, BP | 200 |
| CDR1 -B-1R7*-- | 1.7 | B, C, D | BG, BP | 200/500 | CDR1 -B-271C-- | 270 | F, G, J, K, M | BG, BP | 200 |
| CDR1 -B-1R8*-- | 1.8 | B, C, D | BG, BP | 200/500 | CDR1 -B-301C-- | 300 | F, G, J, K, M | BG, BP | 200 |
| CDR1 -B-1R9*-- | 1.9 | B, C, D | BG, BP | 200/500 | CDR1 -B-331C-- | 330 | F, G, J, K, M | BG, BP | 200 |
| CDR1 -B-2R0*-- | 2.0 | B, C, D | BG, BP | 200/500 | CDR1 -B-361C-- | 360 | F, G, J, K, M | BG, BP | 200 |
| CDR1 -B-2R1*-- | 2.1 | B, C, D | BG, BP | 200/500 | CDR1 -B-391C-- | 390 | F, G, J, K, M | BG, BP | 200 |
| CDR1 -B-2R2*-- | 2.2 | B, C, D | BG, BP | 200/500 | CDR1 -B-431C-- | 430 | F, G, J, K, M | BG, BP | 200 |
| CDR1 -B-2R4*-- | 2.4 | B, C, D | BG, BP | 200/500 | CDR1 -B-471C-- | 470 | F, G, J, K, M | BG, BP | 200 |
| CDR1 -B-2R7*-- | 2.7 | B, C, D | BG, BP | 200/500 | CDR1 -B-511B-- | 510 | F, G, J, K, M | BG, BP | 100 |
| CDR1 -B-3R0*-- | 3.0 | B, C, D | BG, BP | 200/500 | CDR1 -B-561B-- | 560 | F, G, J, K, M | BG, BP | 100 |
| CDR1 -B-3R3*-- | 3.3 | B, C, D | BG, BP | 200/500 | CDR1 -B-621B-- | 620 | F, G, J, K, M | BG, BP | 100 |
| CDR1 -B-3R6*-- | 3.6 | B, C, D | BG, BP | 200/500 | CDR1 -B-681A-- | 680 | F, G, J, K, M | BG, BP | 50 |
| CDR1 -B-3R9*-- | 3.9 | B, C, D | BG, BP | 200/500 | CDR1 -B-751A-- | 750 | F, G, J, K, M | BG, BP | 50 |
| CDR1 -B-4R3*-- | 4.3 | B, C, D | BG, BP | 200/500 | CDR1 -B-821A-- | 820 | F, G, J, K, M | BG, BP | 50 |
| CDR1 -B-4R7*-- | 4.7 | B, C, D | BG, BP | 200/500 | CDR1 -B-911A-- | 910 | F, G, J, K, M | BG, BP | 50 |
| CDR1 -B-5R1*-- | 5.1 | B, C, D | BG, BP | 200/500 | CDR1 -B-102A-- | 1000 | F, G, J, K, M | BG, BP | 50 |
| CDR1 -B-5R6*-- | 5.6 | B, C, D | BG, BP | 200/500 | CDR1 -B-112A-- | 1100 | F, G, J, K, M | BP | 50 |
| CDR1 -B-6R2*-- | 6.2 | B, C, D | BG, BP | 200/500 | CDR1 -B-122A-- | 1200 | F, G, J, K, M | BP | 50 |
| CDR1 -B-6R8*-- | 6.8 | B, C, J, K, M | BG, BP | 200/500 | CDR1 -B-132A-- | 1300 | F, G, J, K, M | BP | 50 |
| CDR1 -B-7R5*-- | 7.5 | B, C, J, K, M | BG, BP | 200/500 | CDR1 -B-152A-- | 1500 | F, G, J, K, M | BP | 50 |
| CDR1 -B-8R2*-- | 8.2 | B, C, J, K, M | BG, BP | 200/500 | CDR1 -B-162A-- | 1600 | F, G, J, K, M | BP | 50 |
| CDR1 -B-9R1*-- | 9.1 | B, C, J, K, M | BG, BP | 200/500 | CDR1 -B-182A-- | 1800 | F, G, J, K, M | BP | 50 |
| CDR1 -B-100*-- | 10 | F, G, J, K, M | BG, BP | 200/500 | CDR1 -B-202A-- | 2000 | F, G, J, K, M | BP | 50 |
| CDR1 -B-110*-- | 11 | F, G, J, K, M | BG, BP | 200/500 | CDR1 -B-222A-- | 2200 | F, G, J, K, M | BP | 50 |
| CDR1 -B-120*-- | 12 | F, G, J, K, M | BG, BP | 200/500 | CDR1 -B-242A-- | 2400 | F, G, J, K, M | BP | 50 |
| CDR1 -B-130*-- | 13 | F, G, J, K, M | BG, BP | 200/500 | CDR1 -B-272A-- | 2700 | F, G, J, K, M | BP | 50 |
| CDR1 -B-150*-- | 15 | F, G, J, K, M | BG, BP | 200/500 | CDR1 -B-302A-- | 3000 | F, G, J, K, M | BP | 50 |
| CDR1 -B-160*-- | 16 | F, G, J, K, M | BG, BP | 200/500 | CDR1 -B-332A-- | 3300 | F, G, J, K, M | BP | 50 |
| CDR1 -B-180*-- | 18 | F, G, J, K, M | BG, BP | 200/500 | CDR1 -B-362A-- | 3600 | F, G, J, K, M | BP | 50 |
| CDR1 -B-200*-- | 20 | F, G, J, K, M | BG, BP | 200/500 | CDR1 -B-392A-- | 3900 | F, G, J, K, M | BP | 50 |
| CDR1 -B-220*-- | 22 | F, G, J, K, M | BG, BP | 200/500 | CDR1 -B-432A-- | 4300 | F, G, J, K, M | BP | 50 |
| CDR1 -B-240*-- | 24 | F, G, J, K, M | BG, BP | 200/500 | CDR1 -B-472A-- | 4700 | F, G, J, K, M | BP | 50 |
| CDR1 -B-270*-- | 27 | F, G, J, K, M | BG, BP | 200/500 | CDR1 -B-502A-- | 5000 | F, G, J, K, M | BP | 50 |
| CDR1 -B-300*-- | 30 | F, G, J, K, M | BG, BP | 200/500 | CDR1 -B-512A-- | 5100 | F, G, J, K, M | BP | 50 |
| CDR1 -B-330*-- | 33 | F, G, J, K, M | BG, BP | 200/500 | | | | | |
| CDR1 -B-360*-- | 36 | F, G, J, K, M | BG, BP | 200/500 | | | | | |
| CDR1 -B-390*-- | 39 | F, G, J, K, M | BG, BP | 200/500 | | | | | |
| CDR1 -B-430*-- | 43 | F, G, J, K, M | BG, BP | 200/500 | | | | | |
| CDR1 -B-470*-- | 47 | F, G, J, K, M | BG, BP | 200/500 | | | | | |
| CDR1 -B-510*-- | 51 | F, G, J, K, M | BG, BP | 200/500 | | | | | |

1/Complete type designation will include additional symbols to indicate style, voltage-temperature limits, capacitance tolerance (where applicable), termination finish ("M" or "N" for style CDR13, and "S", "U", "W", "Y" or "Z" for style CDR14) and failure rate level.

*C=200V; E=500V.

‡C=200V; D=300V.



TYPICAL Q vs. FREQUENCY
AQ11/12
MIL-PRF-55681E - BG
STANDARD - M

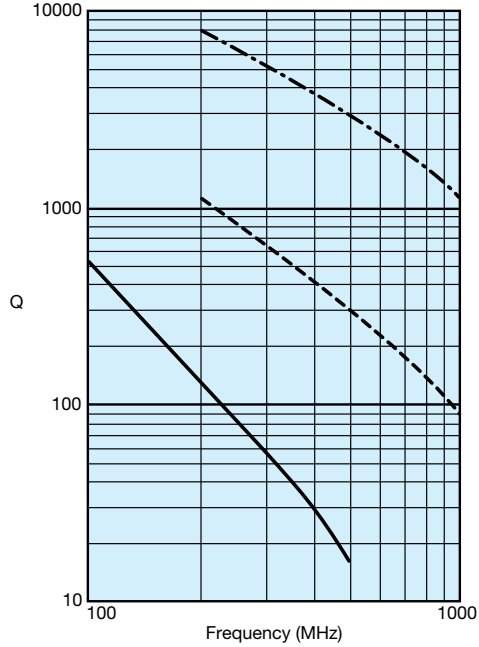

TYPICAL ESR vs. FREQUENCY
AQ11/12
MIL-PRF-55681E - BG
STANDARD - M

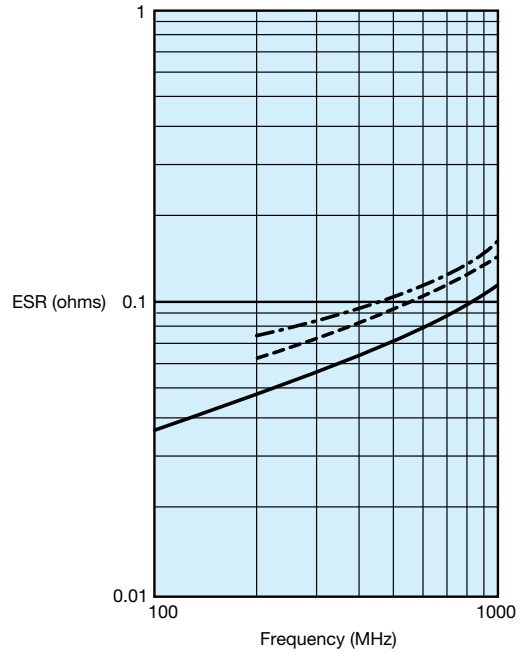

TYPICAL Q vs. CAPACITANCE
AQ11/12
MIL-PRF-55681E - BG
STANDARD - M

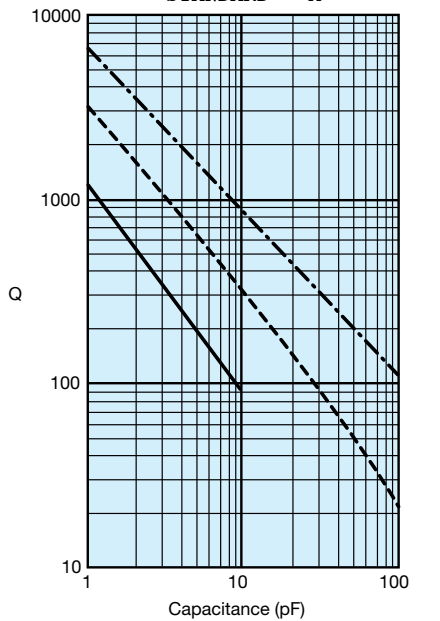

TYPICAL ESR vs. CAPACITANCE
AQ11/12
MIL-PRF-55681E - BG
STANDARD - M

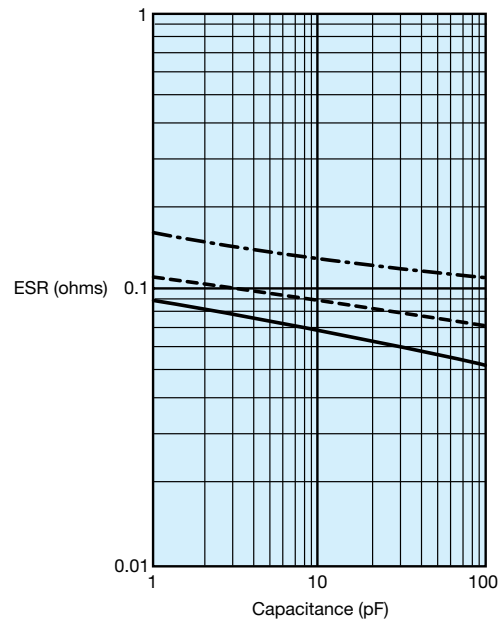

Performance Curves

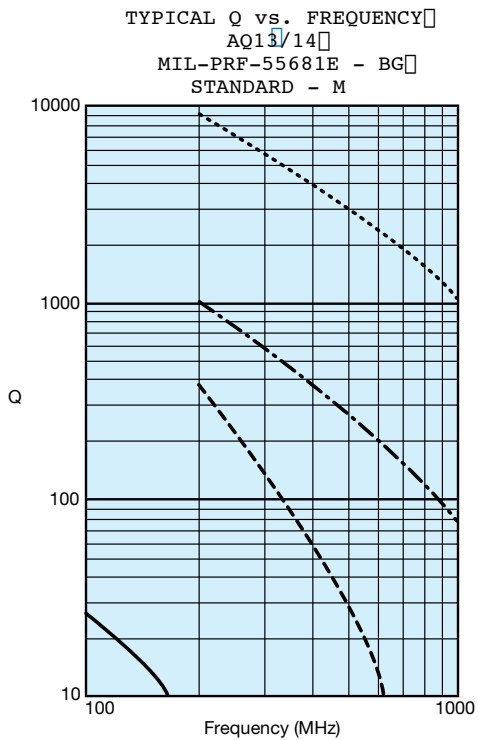

AVX CORPORATION
 1 Picofarad - - - 10 Picofarad - - - 47 Picofarad — 330 Picofarad

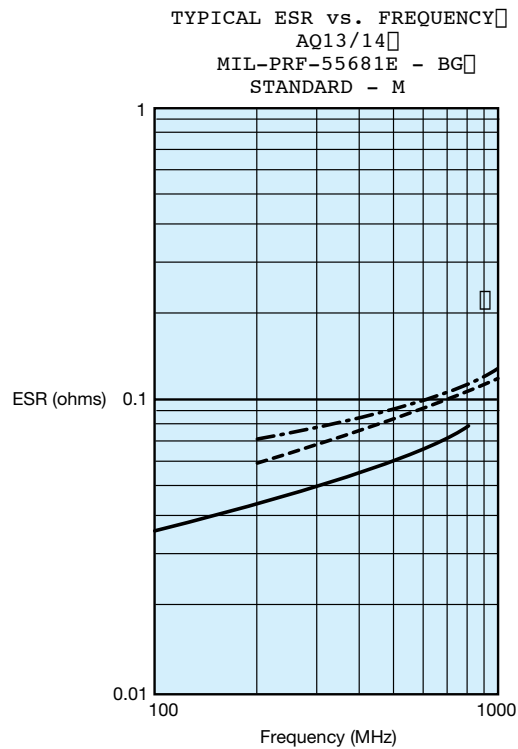

AVX CORPORATION
 1 Picofarad - - - 15 Picofarad — 100 Picofarad

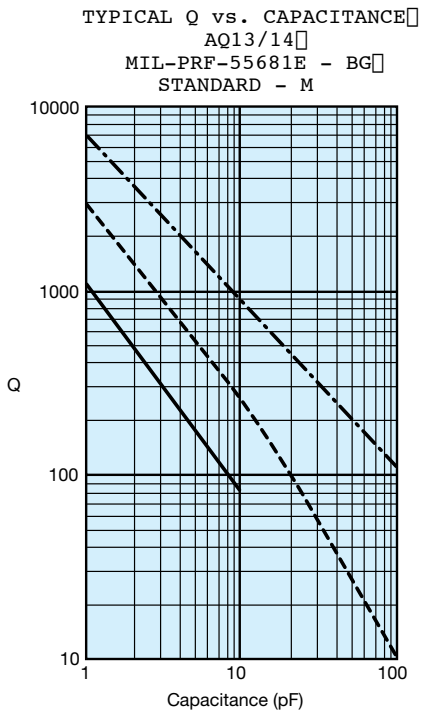

AVX CORPORATION
 250 MHz - - - 500 MHz — 1000 MHz

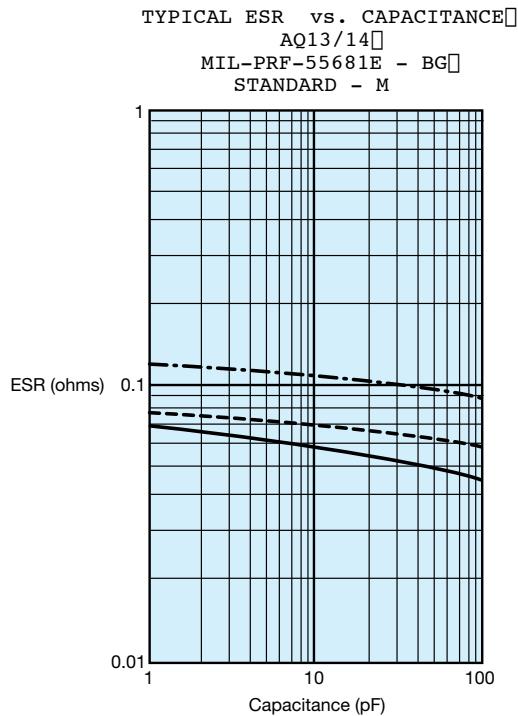

AVX CORPORATION
 250 MHz - - - 500 MHz - - - 1000 MHz

TYPICAL Q vs. FREQUENCY
AQ11/12
MIL-PRF-55681E - BP
STANDARD - A

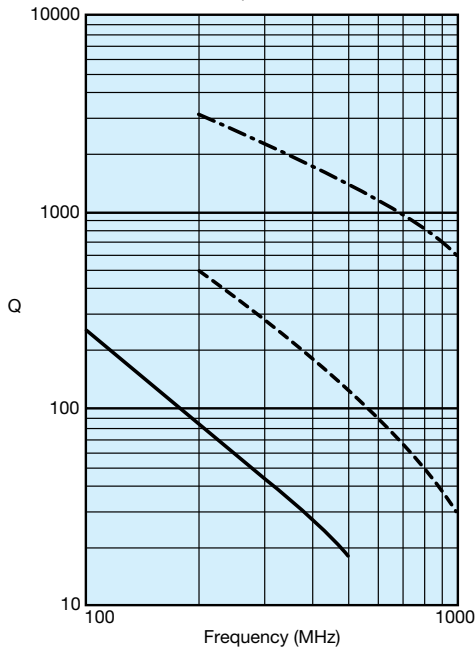

AVX CORPORATION
--- 1 Picofarad --- 15 Picofarad — 100 Picofarad

TYPICAL ESR vs. FREQUENCY
AQ11/12
MIL-PRF-55681E - BP
STANDARD - A

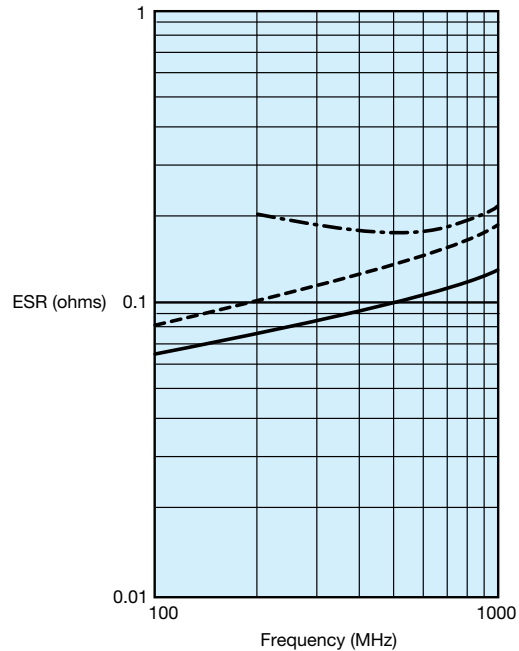

AVX CORPORATION
--- 1 Picofarad --- 15 Picofarad — 100 Picofarad

TYPICAL Q vs. CAPACITANCE
AQ11/12
MIL-PRF-55681E - BP
STANDARD - A

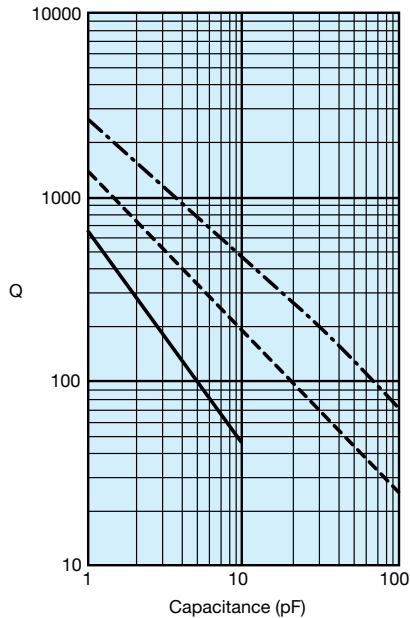

AVX CORPORATION
--- 250 MHz --- 500 MHz — 1000 MHz

TYPICAL ESR vs. CAPACITANCE
AQ11/12
MIL-PRF-55681E - BP
STANDARD - A

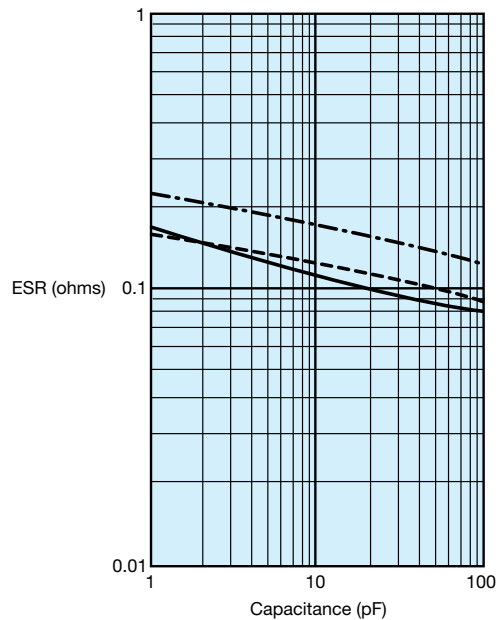

AVX CORPORATION
--- 250 MHz --- 500 MHz --- 1000 MHz

TYPICAL Q vs. FREQUENCY
AQ13/14
MIL-PRF-55681E - BP
STANDARD - A

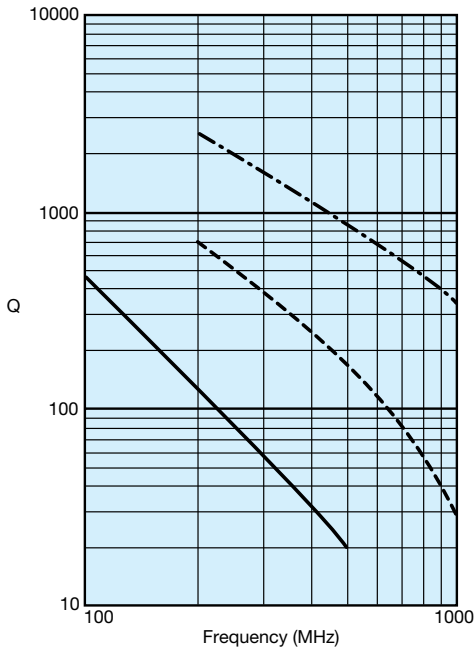

AVX CORPORATION
--- 2 Picofarad - - - 15 Picofarad — 100 Picofarad

TYPICAL ESR vs. FREQUENCY
AQ13/14
MIL-PRF-55681E - BP
STANDARD - A

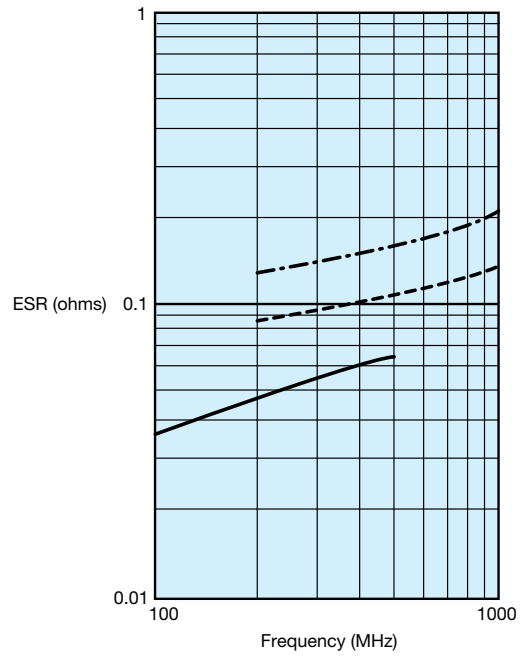

AVX CORPORATION
--- 15 Picofarad - - - 47 Picofarad — 100 Picofarad

TYPICAL Q vs. CAPACITANCE
AQ13/14
MIL-PRF-55681E - BP
STANDARD - A

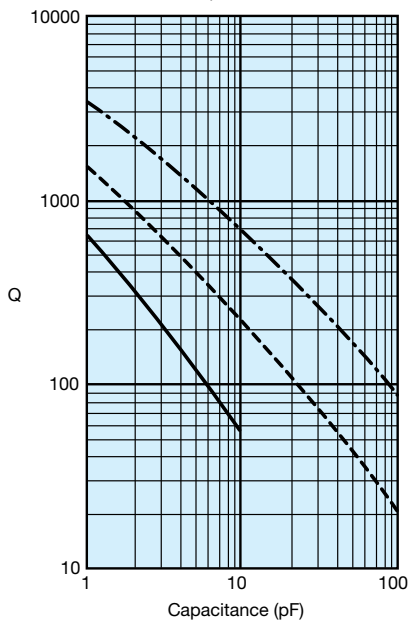

AVX CORPORATION
--- 250 MHz - - - 500 MHz — 1000 MHz

TYPICAL ESR vs. CAPACITANCE
AQ13/14
MIL-PRF-55681E - BP
STANDARD - A

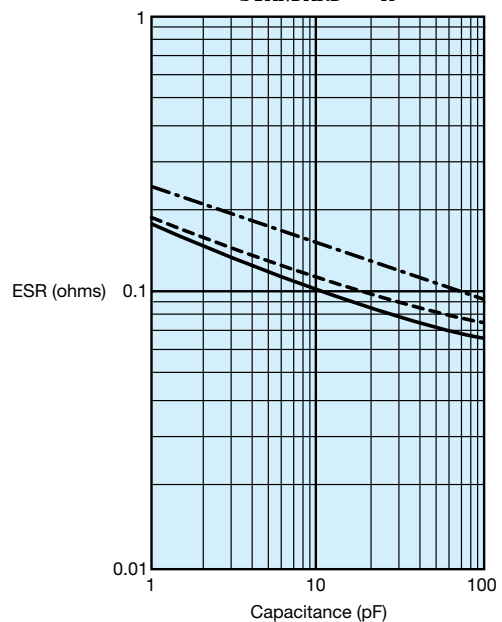

AVX CORPORATION
--- 250 MHz - - - 500 MHz - - - 1000 MHz

TYPICAL RESONANT FREQUENCY vs. CAPACITANCE
AVX AQ11-14 (CDR11-14)

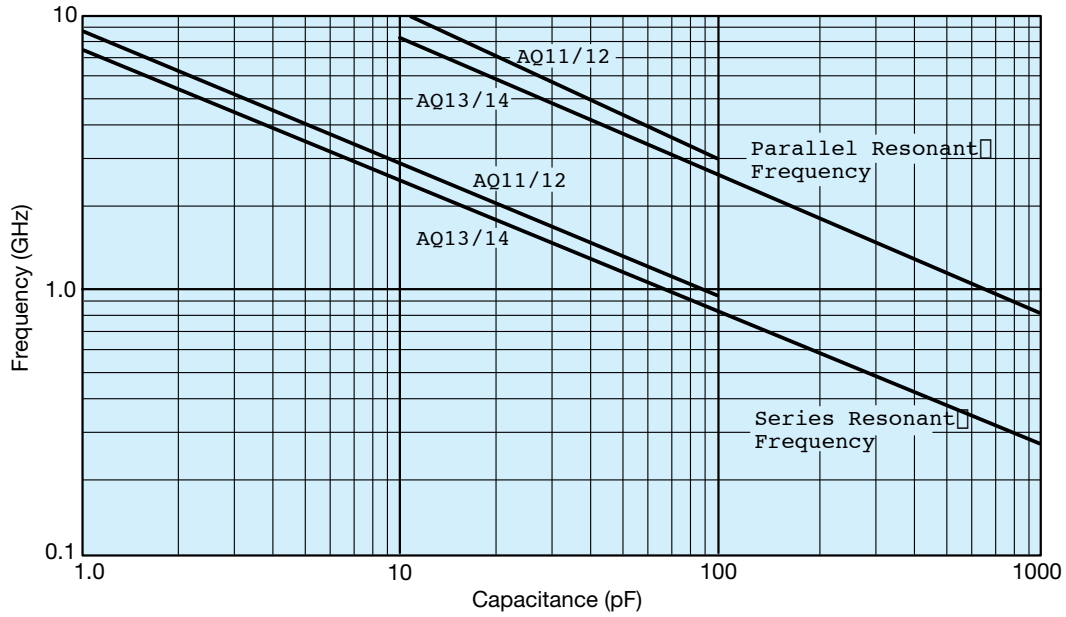

TYPICAL RESONANT FREQUENCY vs. CAPACITANCE
AVX 0603

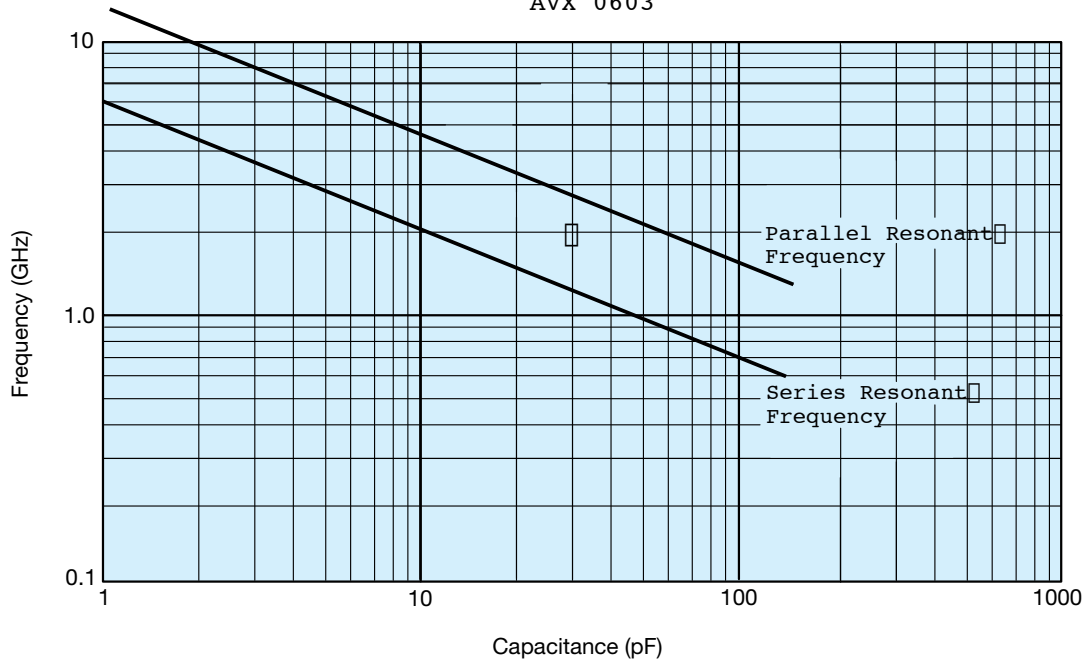

Microwave MLC's

Automatic Insertion Packaging



TAPE & REEL: All tape and reel specifications are in compliance with EIA RS481 (equivalent to IEC 286 part 3).

Sizes SQCA through SQCB, CDR11/12 through 13/14.

- 8mm carrier
- 7" reel: ≤ 0.040 " thickness = 2000 pcs
 ≤ 0.075 " thickness = 2000 pcs
- 13" reel: ≤ 0.075 " thickness = 10,000 pcs

"U" Series - 402/0603/0805/1210 Size Chips

- 8mm carrier
- 7" reel: 0402 = 10,000 pcs
 0603 & 0805 ≤ 0.40 " thickness = 4000 pcs
 0805 . 0.040" thickness & 1210 = 2000 pcs
- 13" reel: ≤ 0.075 " thickness = 10,000 pcs

REEL DIMENSIONS: millimeters (inches)

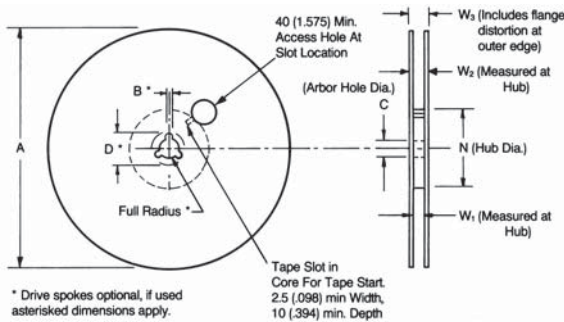

| Tape Size ⁽¹⁾ | A Max. | B* Min. | C | D* Min. | N Min. | W ₁ | W ₂ Max. | W ₃ |
|--------------------------|-----------------|---------------|--------------------------|----------------|---------------|---|---------------------|--|
| 8mm | 330 (12.992) | 1.5 (.059) | 13.0±0.20 (.512±.008) | 20.2 (.795) | 50 (1.969) | 8.4 ^{+1.0} _{-0.0} (.331 ^{+0.003} _{-0.0}) | 14.4 (.567) | 7.9 Min. (.311) 10.9 Max. (.429) |
| 12mm | | | | | | 12.4 ^{+2.0} _{-0.0} (.488 ^{+0.076} _{-0.0}) | 18.4 (.724) | 11.9 Min. (.469) 15.4 Max. (.607) |

Metric dimensions will govern.
 English measurements rounded and for reference only.
 (1) For tape sizes 16mm and 24mm (used with chip size 3640) consult EIA RS-481 latest revision.

EMBOSSED CARRIER CONFIGURATION

8 & 12 MM TAPE ONLY

CONSTANT DIMENSIONS

| Tape Size | D ₀ | E | P ₀ | P ₂ | T Max. | T ₁ | G ₁ | G ₂ |
|--------------|---|------------------------------|-----------------------------|-----------------------------|-----------------|------------------------|------------------------|------------------------|
| 8mm and 12mm | 8.4 ^{+0.10} _{-0.0} (.059 ^{+0.004} _{-0.0}) | 1.75 ± 0.10 (.069 ± .004) | 4.0 ± 0.10 (.157 ± .004) | 2.0 ± 0.05 (.079 ± .002) | 0.600 (.024) | 0.10 Max. (.004) | 0.75 Min. (.030) | 0.75 Min. (.030) |

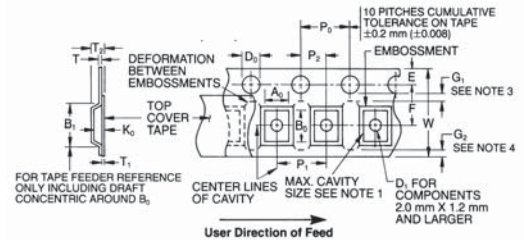

VARIABLE DIMENSIONS

| Tape Size | B ₁ Max. See Note 6 | D ₁ Min. See Note 5 | F | P ₁ | R Min. See Note 2 | T ₂ | W | A ₀ B ₀ K ₀ |
|-----------|-----------------------------------|-----------------------------------|-----------------------------|-----------------------------|----------------------|-------------------|--|--|
| 8mm | 4.55 (.179) | 1.0 (.039) | 3.5 ± 0.05 (.138 ± .002) | 4.0 ± 0.10 (.157 ± .004) | 25 (.984) | 2.5 Max (.098) | 8.0 ^{+0.3} _{-0.1} (.315 ^{+0.012} _{-0.004}) | See Note 1 |
| 12mm | 8.2 (.323) | 1.5 (.059) | 5.5 ± 0.05 (.217 ± .002) | 4.0 ± 0.10 (.157 ± .004) | 30 (1.181) | 6.5 Max (.256) | 12.0 ± .30 (.472 ± .012) | See Note 1 |

NOTES:

- A₀, B₀, and K₀ are determined by the max. dimensions to the ends of the terminals extending from the component body and/or the body dimensions of the component. The clearance between the end of the terminals or body of the component to the sides and depth of the cavity (A₀, B₀, and K₀) must be within 0.05 mm (.002) min. and 0.50 mm (.020) max. The clearance allowed must also prevent rotation of the component within the cavity of not more than 20 degrees (see sketches C & D).
- Tape with components shall pass around radius "R" without damage. The minimum trailer length (Note 2 Fig. 3) may require additional length to provide R min. for 12mm embossed tape for reels with hub diameters approaching N min. (Table 4).
- G₁ dimension is the flat area from the edge of the sprocket hole to either the outward deformation of the carrier tape between the embossed cavities or to the edge of the cavity whichever is less.
- G₂ dimension is the flat area from the edge of the carrier tape opposite the sprocket holes to either the outward deformation of the carrier tape between the embossed cavity or to the edge of the cavity whichever is less.
- The embossment hole location shall be measured from the sprocket hole controlling the location of the embossment. Dimensions of embossment location and hole location shall be applied independent of each other.
- B₁ dimension is a reference dimension for tape feeder clearance only.

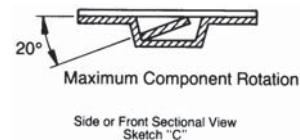
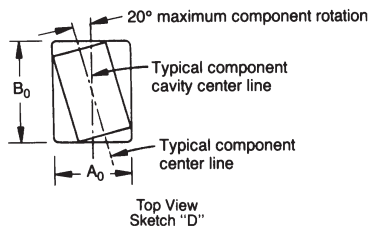

Hi-Q® High RF Power MLC Surface Mount Capacitors

For 600V to 7200V Applications



PRODUCT OFFERING

Hi-Q®, high RF power, surface mount MLC capacitors from AVX Corporation are characterized with ultra-low ESR and dissipation factor at high frequencies. They are designed to handle high power and high voltage levels for applications in RF power amplifiers, inductive heating, high magnetic field environments (MRI coils), medical and industrial electronics.

HOW TO ORDER

| AVX Style | Voltage | Temperature Coefficient | Capacitance Code | Capacitance Tolerance | Test Level | Termination* | Packaging |
|-----------|-----------|-------------------------|---------------------------------------|-----------------------|--------------|---------------------------------------|-------------------|
| HQCC | 300V = 9 | C0G = A | (2 significant digits + no. of zeros) | B = 0.1pF (<8.2pF) | A = Standard | T = Plated Ni and Sn (RoHS Compliant) | 1A = 7" Reel* |
| HQCE | 500V = 7 | P90 = M | Examples: | C = ±0.25pF (<8.2pF) | | J = 5% Min Pb | 6A = Waffle Pack |
| HQLC | 800V = U | | 4.7 pF = 4R7 | D = ±0.50pF (<8.2pF) | | 7 = Plated Ni and Au | *HQCC & HQCE only |
| HQLE | 1000V = A | | 10 pF = 100 | F = ±1% (≥10pF) | | A = Axial Ribbon | |
| | 1500V = S | | 100 pF = 101 | G = ±2% | | M = Microstrip | |
| | 2500V = W | | 1,000 pF = 102 | J = ±5% | | H = Cu/Sn (Non-Magnetic) | |
| | 3000V = H | | | K = ±10% | | 4 = Axial Ribbon (Non-Magnetic) | |
| | 3600V = J | | | M = ±20% | | 5 = Microstrip (Non-Magnetic) | |
| | 5000V = K | | | | | | |
| | 7200V = M | | | | | | |

DIMENSIONS

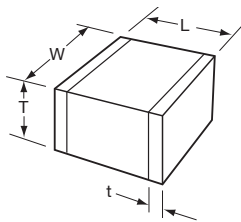

mm (inches)

| STYLE | HQCC | HQCE |
|--------------------|--|---|
| (L) Length | 5.84 +0.51 -0.25 (0.230 +0.020 -0.010) | 9.65 +0.38 -0.25 (0.380 +0.015 -0.010) |
| (W) Width | 6.35 ± 0.38 (0.250 ± 0.015) | 9.65 ± 0.25 (0.380 ± 0.010) |
| (T) Thickness Max. | 3.68 (0.145) max. for capacitance values ≤ 680pF 4.19 (0.165) max. for capacitance values > 680pF | 4.32 (0.170) max. |
| (t) Overlap | 1.02 (0.040) max. | 1.02 (0.040) max. |

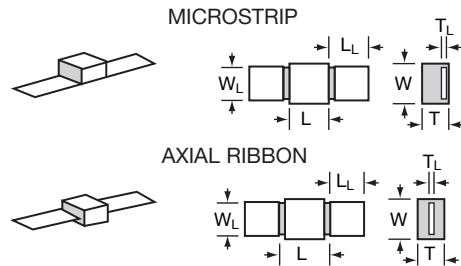

mm (inches)

| STYLE | HQLC | HQLE |
|----------------------------------|--|---|
| (L) Length | 6.22 ± 0.64 (0.245 ± 0.025) | 9.65 +0.89 -0.25 (0.380 +0.035 -0.010) |
| (W) Width | 6.35 ± 0.38 (0.250 ± 0.015) | 9.65 ± 0.25 (0.380 ± 0.010) |
| (T) Thickness Max. | 3.68 (0.145) max. for capacitance values ≤ 680pF 4.19 (0.165) max. for capacitance values ≤ 680pF | 4.32 (0.170) max. |
| (L _L) Lead Length | 12.7 min. (0.500) | 19.05 (0.750) |
| (W _L) Lead Width | 6.10 ± 0.127 (0.240 ± 0.005) | 8.89 ± 0.25 (0.350 ± 0.010) |
| (T _L) Lead Thickness | 0.102 ± 0.025 (0.004 ± 0.001) | 0.25 ± 0.13 (0.010 ± 0.005) |
| Lead Material | High Purity Silver Leads Leads are attached with High Temperature Solder | High Purity Silver Leads Leads are attached with High Temperature Solder |

Not RoHS Compliant



For RoHS compliant products,
please select correct termination style.

Hi-Q[®] High RF Power MLC Surface Mount Capacitors

For 600V to 7200V Applications



DIELECTRIC PERFORMANCE CHARACTERISTICS

| | |
|------------------------------------|---|
| Capacitance Range | 1.0pF to 2,700pF (25°C, 1.0 ±0.2 Vrms at 1kHz, for ≤ 1000 pF use 1MHz) |
| Capacitance Tolerances | ±0.10pF, ±0.25pF, ±0.50pF, ±1%, ±2%, ±5%, ±10%, ±20% |
| Dissipation Factor 25°C | 0.1% Max (+25°C, 1.0 ±0.2 Vrms at 1kHz, for ≤ 1000 pF use 1MHz) |
| Operating Temperature Range | -55°C to +125°C |
| Temperature Characteristic | C0G: 0 ± 30 ppm/°C (-55°C to +125°C), P90: 90 ± 30 ppm/°C (-55°C to +125°C) |
| Insulation Resistance | 100K MΩ min. @ +25°C and 500VDC 10K MΩ min. @ +125°C and 500VDC |
| Dielectric Strength | 250% of WVDC for capacitors rated at 500 volts DC or less for 5 seconds. 150% of WVDC for capacitors rated at 1250 volts DC or less for 5 seconds. 120% of WVDC for capacitors rated above 1250 volts DC or less for 5 seconds. |

HQCC CAPACITANCE VALUES (A DIELECTRIC)

| Cap Code | Cap (pF) | Tol. | Rated WVDC | Cap Code | Cap (pF) | Tol. | Rated WVDC | Cap Code | Cap (pF) | Tol. | Rated WVDC | Cap Code | Cap (pF) | Tol. | Rated WVDC |
|----------|----------|---------|------------|----------|----------|---------|------------|----------|----------|-----------------|------------|----------|----------|-----------------|------------|
| 1R0 | 1.0 | B, C, D | 2500 | 8R2 | 8.2 | B, C, D | 2500 | 680 | 68 | F, G, J K, M | 2500 | 471 | 470 | F, G, J K, M | 1500 |
| 1R2 | 1.2 | | | 100 | 10 | 820 | | 82 | 561 | | | 560 | 1000 | | |
| 1R5 | 1.5 | | | 120 | 12 | 101 | | 100 | 681 | | | 680 | | | |
| 1R8 | 1.8 | | | 150 | 15 | 121 | | 120 | 821 | | | 820 | | | |
| 2R2 | 2.2 | | | 180 | 18 | 151 | | 150 | 102 | | | 1000 | | | |
| 2R7 | 2.7 | | | 220 | 22 | 181 | | 180 | 122 | | | 1200 | | | |
| 3R3 | 3.3 | | | 270 | 27 | 221 | | 220 | 152 | | | 1500 | | | 500 |
| 3R9 | 3.9 | | | 330 | 33 | 271 | | 270 | 182 | | | 1800 | | | |
| 4R7 | 4.7 | | | 390 | 39 | 331 | | 330 | 222 | | | 2200 | | | 300 |
| 5R6 | 5.6 | | | 470 | 47 | 391 | | 390 | 272 | | | 2700 | | | |
| 6R8 | 6.8 | | | 560 | 56 | | | | | | | | | | |

HQCC CAPACITANCE VALUES (M DIELECTRIC)

| Cap Code | Cap (pF) | Tol. | Rated WVDC | | Cap Code | Cap (pF) | Tol. | Rated WVDC | | Cap Code | Cap (pF) | Tol. | Rated WVDC | |
|----------|----------|---------|------------|----------|----------|----------|-----------------|------------|----------|----------|----------|-----------------|------------|----------|
| | | | Standard | Extended | | | | Standard | Extended | | | | Standard | Extended |
| 1R0 | 1.0 | B, C, D | 2500 | 3600 | 100 | 10 | F, G, J K, M | 2500 | 3600 | 161 | 160 | F, G, J K, M | 2500 | 3000 |
| 1R1 | 1.1 | | | | 110 | 11 | | | | 181 | 180 | | | |
| 1R2 | 1.2 | | | | 120 | 12 | | | | 201 | 200 | | | |
| 1R3 | 1.3 | | | | 130 | 13 | | | | 221 | 220 | | | |
| 1R4 | 1.4 | | | | 150 | 15 | | | | 241 | 240 | | | |
| 1R5 | 1.5 | | | | 160 | 16 | | | | 271 | 270 | | | |
| 1R6 | 1.6 | | | | 180 | 18 | | | | 301 | 300 | | | |
| 1R7 | 1.7 | | | | 200 | 20 | | | | 331 | 330 | | | |
| 1R8 | 1.8 | | | | 220 | 22 | | | | 331 | 330 | | | |
| 1R9 | 1.9 | | | | 240 | 24 | | | | 361 | 360 | | | |
| 2R0 | 2.0 | | | | 270 | 27 | | | | 391 | 390 | | | |
| 2R1 | 2.1 | | | | 300 | 30 | | | | 431 | 430 | | | |
| 2R2 | 2.2 | | | | 330 | 33 | | | | 471 | 470 | | | |
| 2R4 | 2.4 | | | | 360 | 36 | | | | 511 | 510 | | | |
| 2R5 | 2.5 | | | | 390 | 39 | | | | 561 | 560 | | | |
| 3R0 | 3.0 | | | | 430 | 43 | | | | 621 | 620 | | | |
| 3R3 | 3.3 | | | | 470 | 47 | | | | 681 | 680 | | | |
| 3R6 | 3.6 | | | | 510 | 51 | | | | 751 | 750 | | | |
| 3R9 | 3.9 | | | | 560 | 56 | | | | 821 | 820 | | | |
| 4R3 | 4.3 | | | | 620 | 62 | | | | 911 | 910 | | | |
| 4R7 | 4.7 | | | | 680 | 68 | | | | 102 | 1000 | | | |
| 5R1 | 5.1 | | | | 750 | 75 | | | | 112 | 1100 | | | |
| 5R6 | 5.6 | | | | 820 | 82 | | | | 122 | 1200 | | | |
| 6R2 | 6.2 | | | | 910 | 91 | | | | 152 | 1500 | | | |
| 6R8 | 6.8 | | | | 101 | 100 | | | | 182 | 1800 | | | |
| 7R5 | 7.5 | | | | 111 | 110 | | | | 222 | 2200 | | | |
| 8R2 | 8.2 | | | | 121 | 120 | | | | 242 | 2400 | | | |
| 9R1 | 9.1 | 131 | 130 | 272 | 2700 | | | | | | | | | |
| | | 151 | 150 | | | | | | | | | | | |

Hi-Q® High RF Power MLC Surface Mount Capacitors

For 600V to 7200V Applications



HQCE CAPACITANCE VALUES (A DIELECTRIC)

| Cap Code | Cap (pF) | Tol. | Rated WVDC | | Cap Code | Cap (pF) | Tol. | Rated WVDC | | Cap Code | Cap (pF) | Tol. | Rated WVDC | |
|----------|----------|------------|------------|----------|----------|----------|------------|------------|----------|----------|----------|------------|------------|----------|
| | | | Standard | Extended | | | | Standard | Extended | | | | Standard | Extended |
| 1R0 | 1.0 | C, D | 3600 | 7200 | 150 | 15 | G, J, K, M | 3600 | 7200 | 221 | 220 | G, J, K, M | 3600 | NA |
| 1R2 | 1.2 | | | | 180 | 18 | | | | 271 | 270 | | | |
| 1R5 | 1.5 | | | | 220 | 22 | | | | 331 | 330 | | | |
| 1R8 | 1.8 | | | | 270 | 27 | | | | 391 | 390 | | | |
| 2R2 | 2.2 | | | | 330 | 33 | | | | 471 | 470 | | | |
| 2R7 | 2.7 | | | | 390 | 39 | | | | 561 | 560 | | | |
| 3R3 | 3.3 | | | | 470 | 47 | | | | 681 | 680 | | | |
| 3R9 | 3.9 | | | | 560 | 56 | | | | 821 | 820 | | | |
| 4R7 | 4.7 | | | | 680 | 68 | | | | 102 | 1000 | | | |
| 5R6 | 5.6 | | | | 820 | 82 | | | | 122 | 1200 | | | |
| 6R8 | 6.8 | 101 | 100 | 152 | 1500 | | | | | | | | | |
| 8R2 | 8.2 | 121 | 120 | 182 | 1800 | | | | | | | | | |
| 100 | 10 | G, J, K, M | 3600 | 7200 | 151 | 150 | G, J, K, M | 3600 | 5000 | 222 | 2200 | G, J, K, M | 1000 | NA |
| 120 | 12 | | | | 181 | 180 | | | | | | | | |

HQCE CAPACITANCE VALUES (M DIELECTRIC)

| Cap Code | Cap (pF) | Tol. | Rated WVDC | | Cap Code | Cap (pF) | Tol. | Rated WVDC | | Cap Code | Cap (pF) | Tol. | Rated WVDC | |
|----------|----------|---------------|------------|----------|----------|----------|---------------|------------|----------|----------|----------|---------------|------------|----------|
| | | | Standard | Extended | | | | Standard | Extended | | | | Standard | Extended |
| 1R0 | 1.0 | B, C, D | 3600 | 7200 | 180 | 18 | F, G, J, K, M | 3600 | 7200 | 331 | 330 | F, G, J, K, M | 3600 | NA |
| 1R2 | 1.2 | | | | 220 | 22 | | | | 391 | 390 | | | |
| 1R5 | 1.5 | | | | 270 | 27 | | | | 471 | 470 | | | |
| 1R8 | 1.8 | | | | 330 | 33 | | | | 561 | 560 | | | |
| 2R2 | 2.2 | | | | 390 | 39 | | | | 681 | 680 | | | |
| 2R7 | 2.7 | | | | 470 | 47 | | | | 821 | 820 | | | |
| 3R3 | 3.3 | | | | 560 | 56 | | | | 102 | 1000 | | | |
| 3R9 | 3.9 | | | | 680 | 68 | | | | 122 | 1200 | | | |
| 4R7 | 4.7 | | | | 820 | 82 | | | | 152 | 1500 | | | |
| 5R6 | 5.6 | | | | 101 | 100 | | | | 182 | 1800 | | | |
| 6R8 | 6.8 | 121 | 120 | 222 | 2200 | | | | | | | | | |
| 8R2 | 8.2 | 151 | 150 | 272 | 2700 | | | | | | | | | |
| 100 | 10 | F, G, J, K, M | 3600 | 7200 | 181 | 180 | F, G, J, K, M | 3600 | 5000 | 332 | 3300 | G, J, K, M | 500 | NA |
| 120 | 12 | | | | 221 | 220 | | | | | | | | |
| 150 | 15 | | | | 271 | 270 | | | | | | | | |

Hi-Q[®] High RF Power MLC Surface Mount Capacitors

For 600V to 7200V Applications



HQCC PERFORMANCE CHARACTERISTICS (A DIELECTRIC)

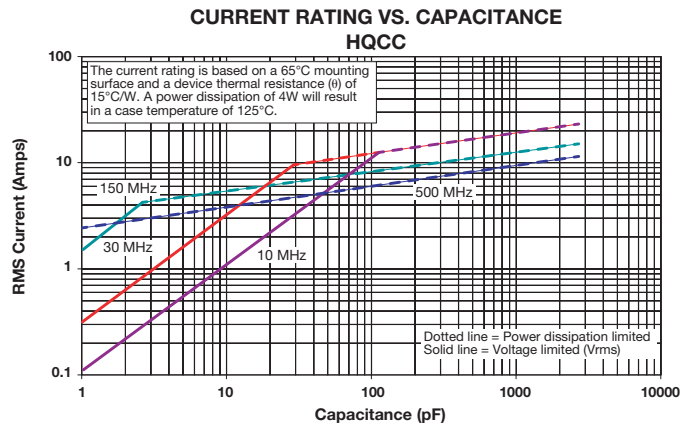
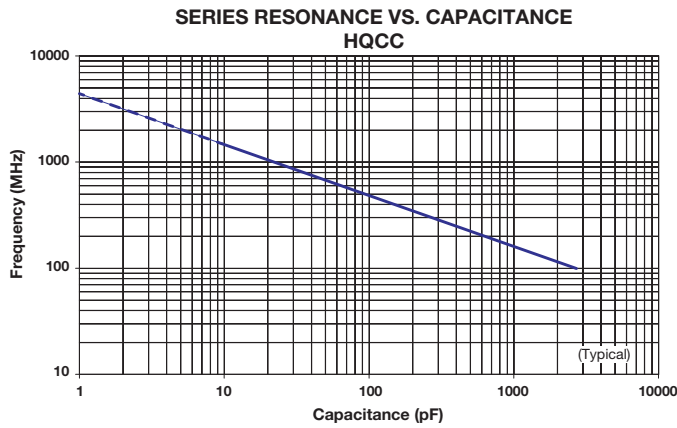
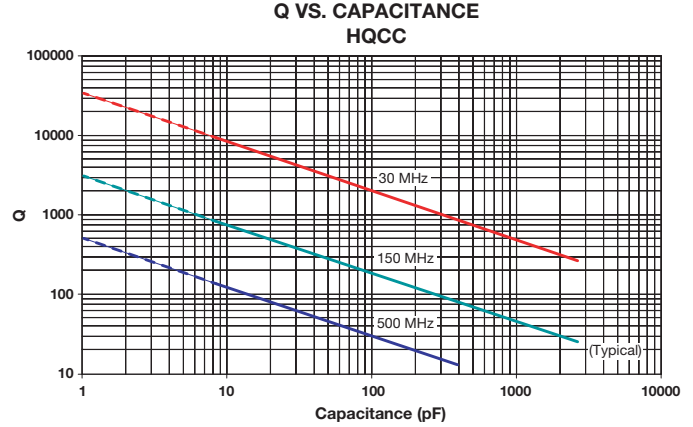
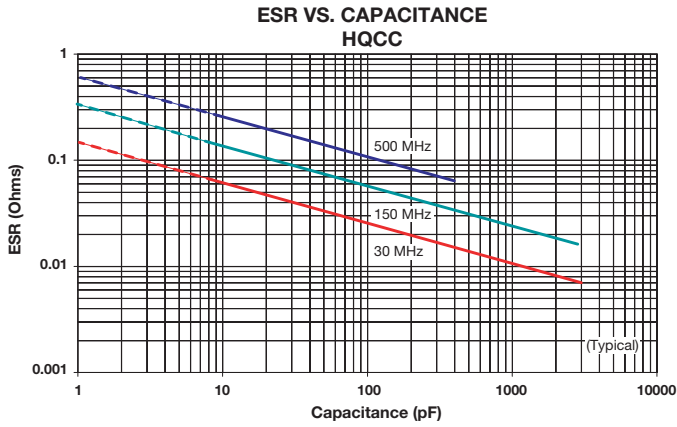

HQCC PERFORMANCE CHARACTERISTICS (M DIELECTRIC)

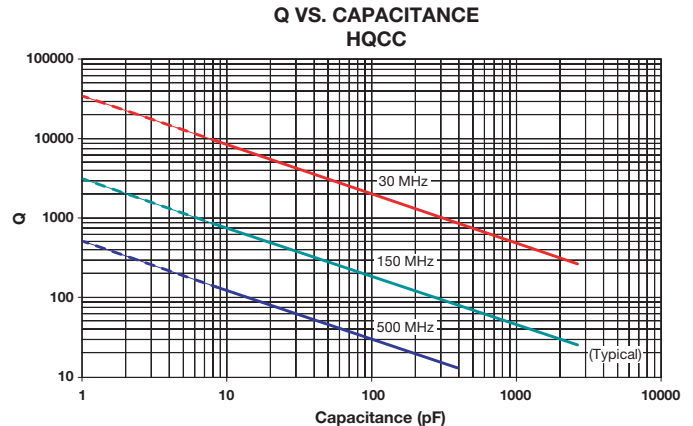
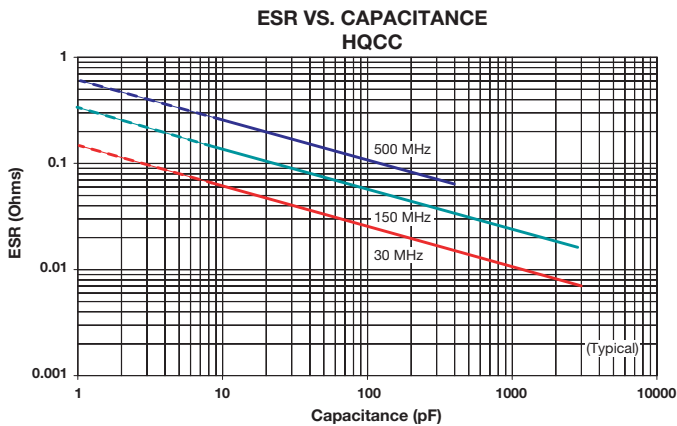

Hi-Q[®] High RF Power MLC Surface Mount Capacitors For 600V to 7200V Applications

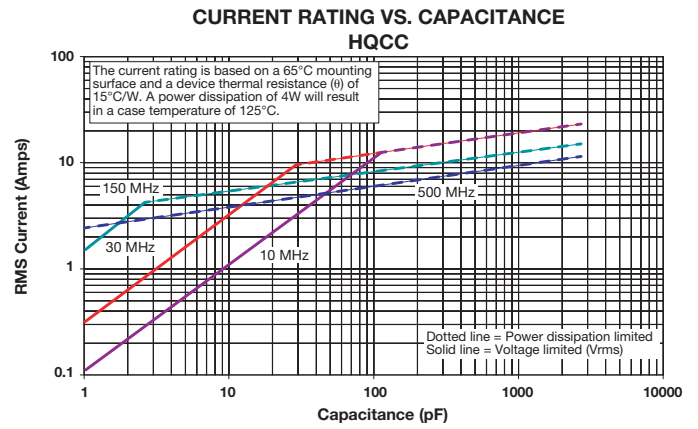
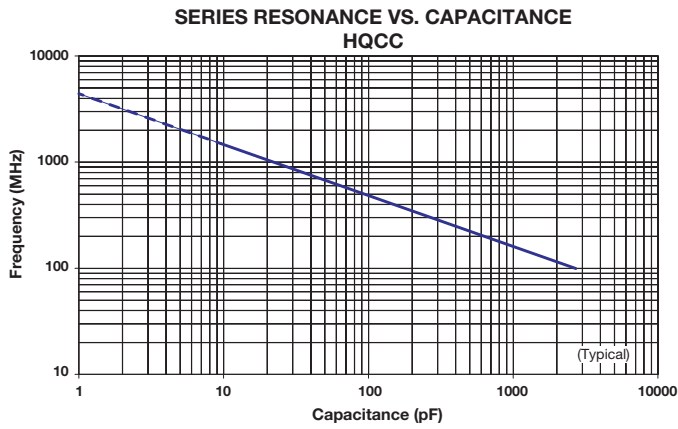

HQCE PERFORMANCE CHARACTERISTICS (A DIELECTRIC)

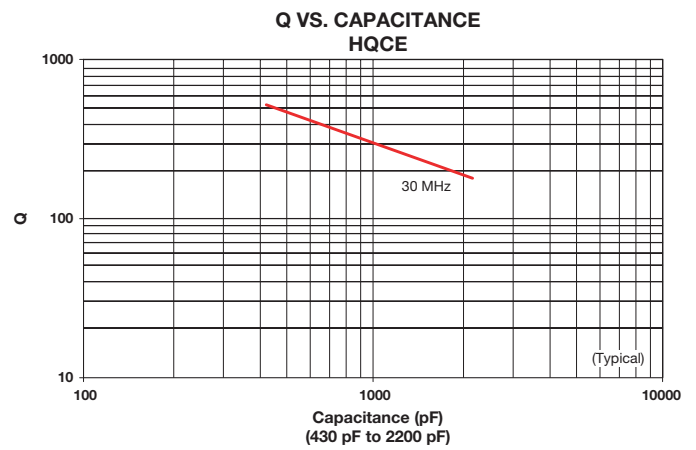
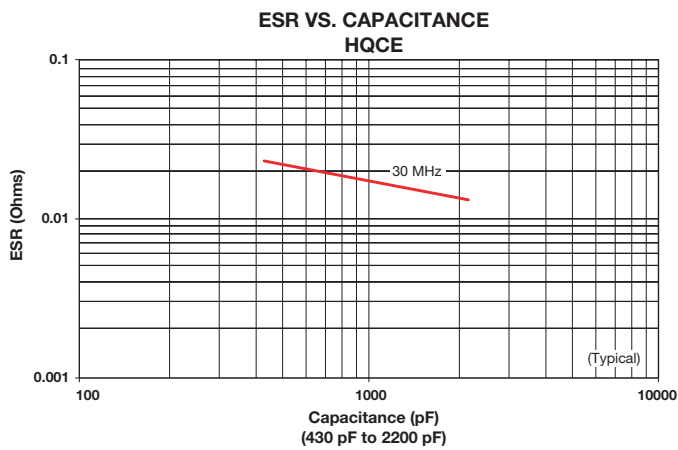
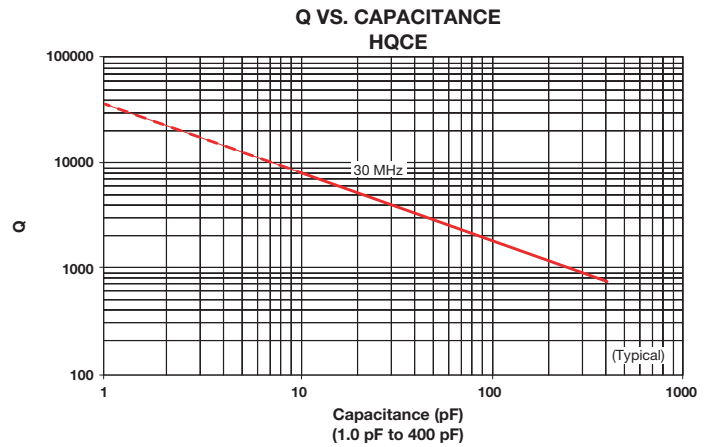
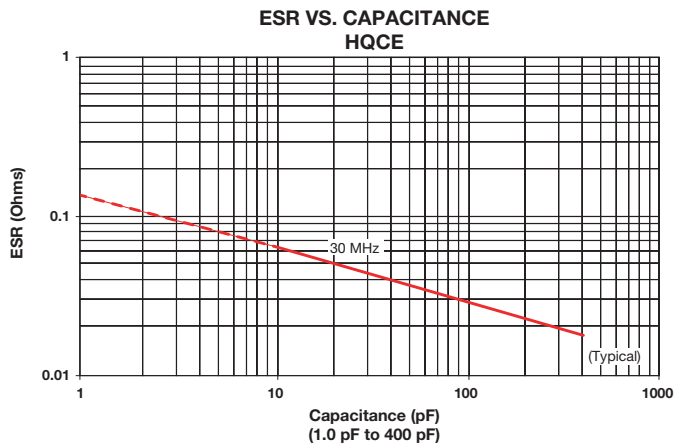

Hi-Q[®] High RF Power MLC Surface Mount Capacitors

For 600V to 7200V Applications



SERIES RESONANCE VS. CAPACITANCE
HQCE

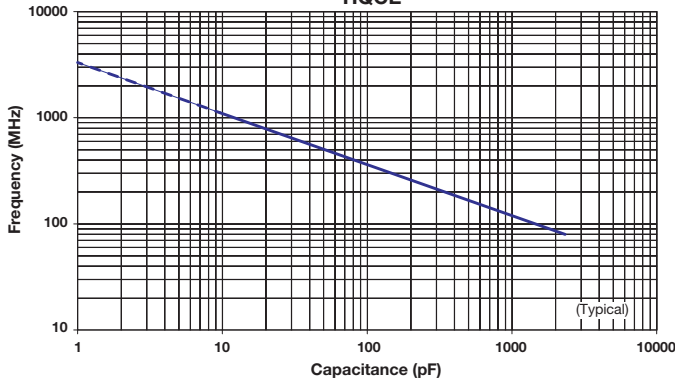

CURRENT RATING VS. CAPACITANCE
HQCE

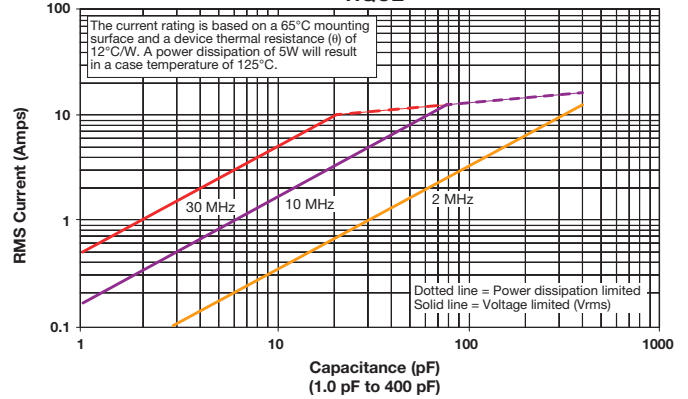

CURRENT RATING VS. CAPACITANCE
HQCE

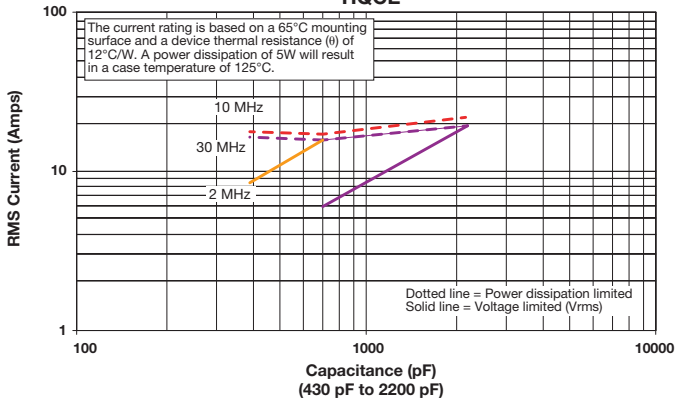

CURRENT RATING VS. CAPACITANCE
HQCE

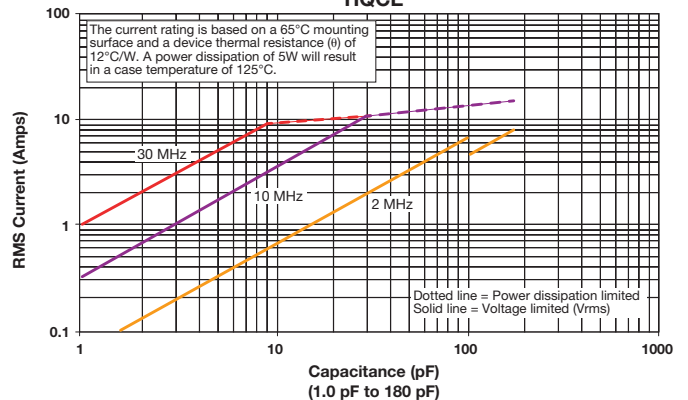

HQCE PERFORMANCE CHARACTERISTICS (M DIELECTRIC)

ESR VS CAPACITANCE
HQCE M Dielectric

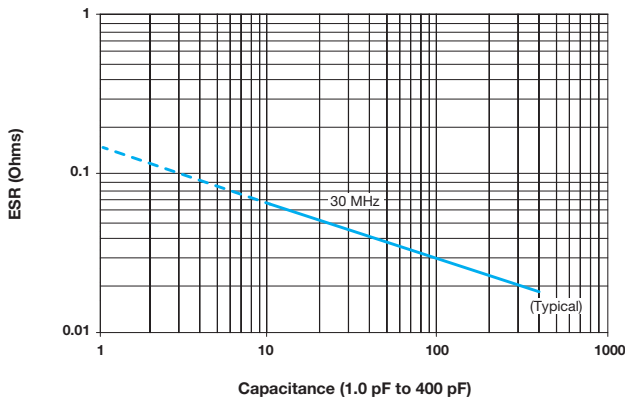

Q VS CAPACITANCE
HQCE M Dielectric

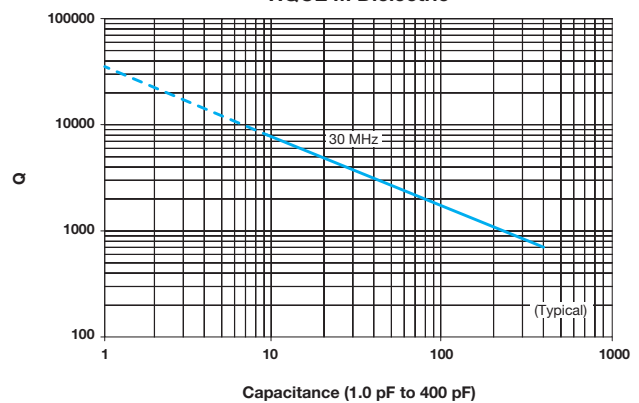

Hi-Q[®] High RF Power MLC Surface Mount Capacitors For 600V to 7200V Applications



ESR VS CAPACITANCE
HQCE M Dielectric

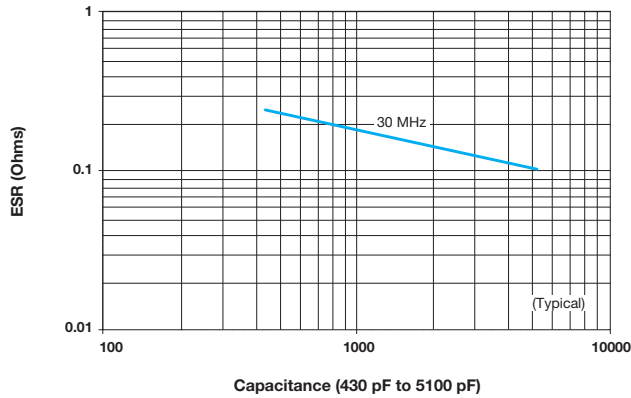

Q VS CAPACITANCE
HQCE M Dielectric

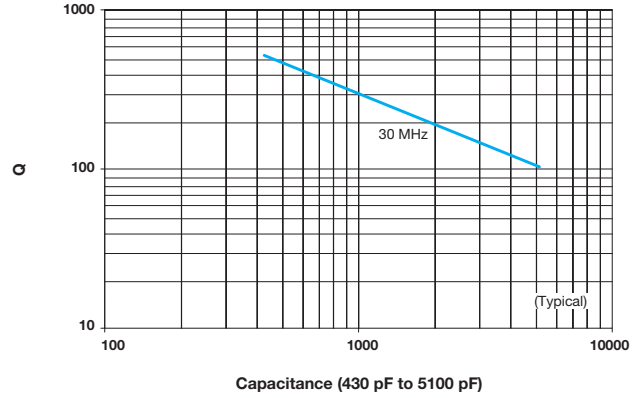

SERIES RESONANCE VS CAPACITANCE
HQCE M Dielectric

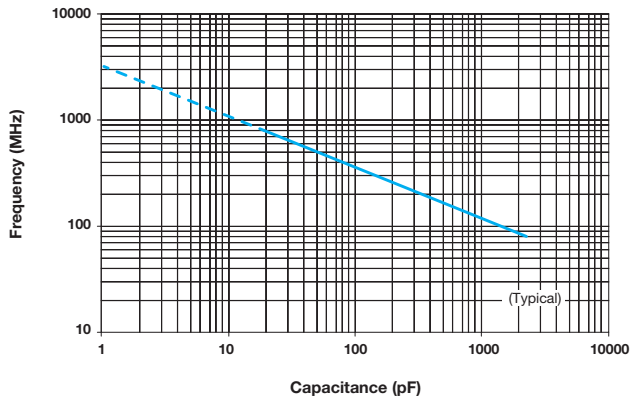

CURRENT RATING VS CAPACITANCE
HQCE M Dielectric

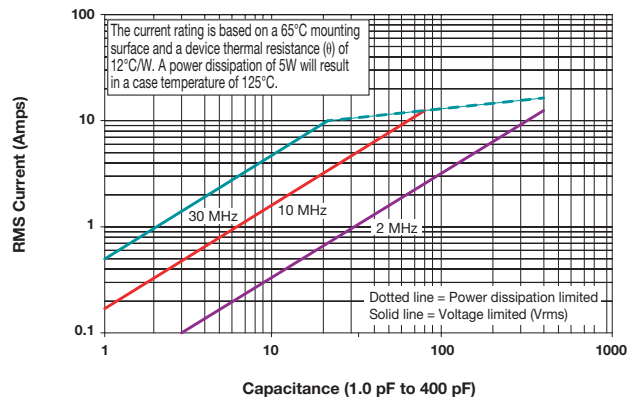

CURRENT RATING VS CAPACITANCE
HQCE M Dielectric

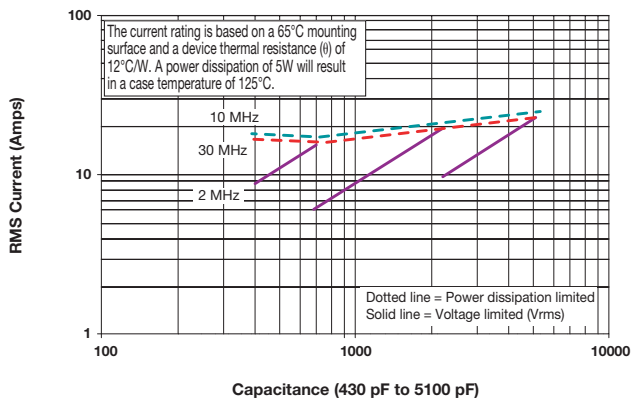

RF/Microwave COG (NP0) Capacitors (RoHS)



Ultra Low ESR, "CU" Series, COG (NP0) Chip Capacitors

GENERAL INFORMATION

"CU" Series capacitors are COG (NP0) chip capacitors specially designed for "Ultra" low ESR for applications in the communications market. Sizes available are EIA chip sizes 01005 and 0201.

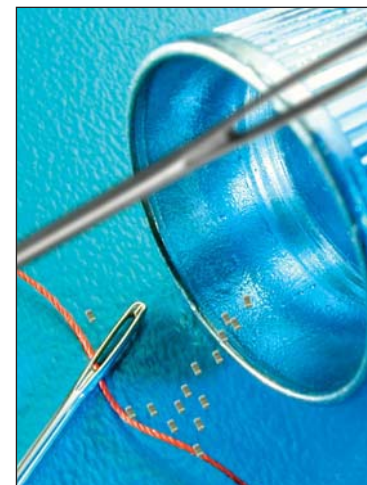

DIMENSIONS:

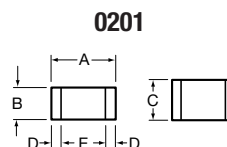
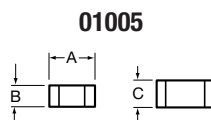
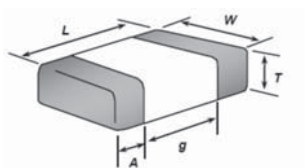

mm (inches)

| Size | L (Length) | W (Width) | T (Max. Thickness) | g (min.) | A (Termination Min./Max.) |
|-----------------|-----------------------------|-----------------------------|-----------------------|-----------------|------------------------------|
| 0402 (01005) | 0.40±0.02 (0.016±0.0008) | 0.20±0.02 (0.008±0.0008) | 0.22 (0.009) | 0.13 (0.005) | 0.70/0.14 (0.003/0.006) |
| 0603 (0201) | 0.60±0.03 (0.024±0.001) | 0.30±0.03 (0.012±0.001) | 0.33 (0.013) | 0.15 (0.006) | 0.10/0.20 (0.004/0.008) |

HOW TO ORDER

| | | | | | | | | |
|---|---|---|--|--|--|--|---|--------------------------------|
| CU01 | 3 | 1 | 100 | J | A | T | 2 | A |
| Case Size CU10 = 01005 CU01 = 0201 | Voltage Code 3 = 25V Y = 16V | Dielectric 1 = 0±30ppm COG (NP0) | Capacitance EIA Capacitance Code in pF. First two digits = significant figures or "R" for decimal place. Third digit = number of zeros or after "R" significant figures. | Capacitance Tolerance Code B = ±0.1pF C = ±0.25pF D = ±0.5pF G = ±2% J = ±5% | Failure Rate Code A = Not Applicable | Termination T = Plated Ni and Sn | Packaging Code 2 = 7" Reel 4 = 13" Reel U = 7" Reel 4mm TR (01005) | Special A = Standard |



ELECTRICAL CHARACTERISTICS

Capacitance Value Range:

Size 01005 0.5 to 22pF
Size 0201 0.5 to 22pF

Temperature Coefficient of Capacitance (TC):

0±30 ppm/°C (-55° to +125°C)

Insulation Resistance (IR):

10¹² Ω min. @ 25°C and rated WVDC
10¹¹ Ω min. @ 125°C and rated WVDC

Working Voltage (WVDC):

Size Working Voltage
01005 - 16 WVDC
0201 - 25 WVDC

RF/Microwave C0G (NP0) Capacitors (RoHS)



Ultra Low ESR, "CU" Series, C0G (NP0) Chip Capacitors

CAPACITANCE RANGE

| Cap (pF) | Available Tolerance | |
|----------|---------------------|-------|
| | 01005 | 0201 |
| 0.5 | B,C,D | B,C,D |
| 0.75 | B,C,D | B,C,D |
| 1.0 | B,C,D | B,C,D |
| 1.2 | B,C,D | B,C,D |
| 1.5 | B,C,D | B,C,D |
| 1.8 | B,C,D | B,C,D |
| 2.2 | B,C,D | B,C,D |
| 2.7 | B,C,D | B,C,D |
| 3.3 | B,C,D | B,C,D |
| 3.9 | B,C,D | B,C,D |
| 4.7 | B,C,D | B,C,D |
| 5.6 | B,C,D | C,D |
| 6.2 | B,C,D | C,D |
| 6.8 | B,C,D | D |
| 8.2 | B,C,D | D |
| 10.0 | G,J,K | J,K |
| 12.0 | G,J,K | J,K |
| 15.0 | G,J,K | J,K |
| 18.0 | G,J,K | J,K |
| 22.0 | G,J,K | J,K |

ULTRA LOW ESR, "CU" SERIES

01005 6.2pF

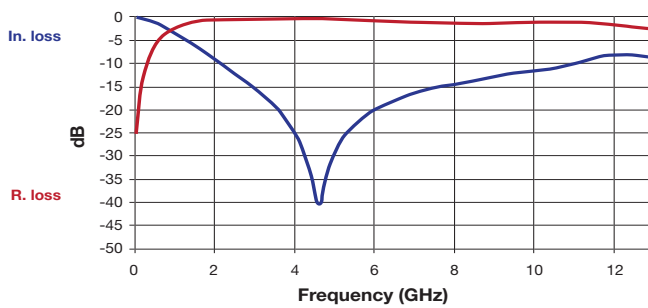

| | F (GHz) | IL | R. loss |
|----|---------|--------|---------|
| F1 | 0.31 | -0.40 | -9.68 |
| F2 | 1.28 | -5.03 | -1.44 |
| F3 | 2.408 | -11.58 | -0.27 |
| F4 | 4.635 | -40.55 | -0.39 |
| F5 | 4.897 | -31.82 | -0.47 |

0201 4.7pF

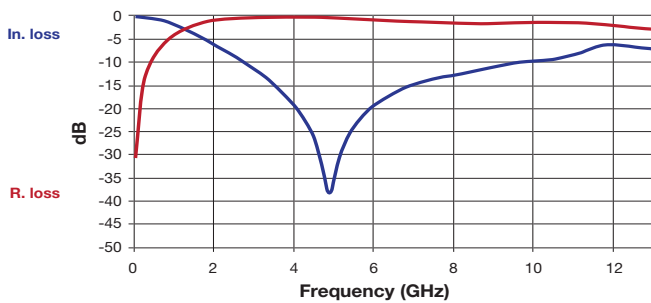

| | F (GHz) | IL | R. loss |
|----|---------|--------|---------|
| F1 | 0.31 | -0.13 | -12.90 |
| F2 | 1.28 | -2.89 | -2.84 |
| F3 | 2.408 | -8.09 | -0.60 |
| F4 | 4.635 | -29.45 | -0.37 |
| F5 | 4.897 | -38.55 | -0.45 |

0201 22pF

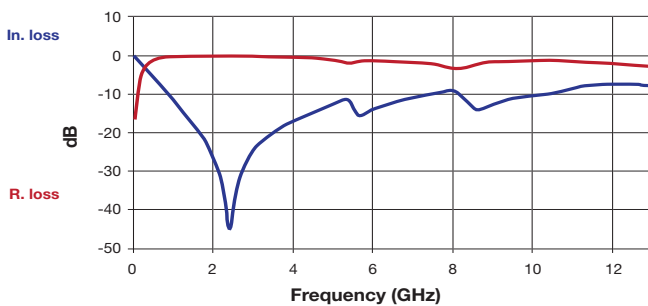

| | F (GHz) | IL | R. loss |
|----|---------|--------|---------|
| F1 | 0.31 | -2.90 | -2.85 |
| F2 | 1.28 | -15.26 | -0.10 |
| F3 | 2.408 | -45.65 | -0.10 |
| F4 | 4.635 | -14.90 | -0.87 |
| F5 | 4.897 | -12.89 | -1.08 |

RF/Microwave COG (NP0) Capacitors (RoHS)



Ultra Low ESR, "U" Series, COG (NP0) Chip Capacitors

GENERAL INFORMATION

"U" Series capacitors are COG (NP0) chip capacitors specially designed for "Ultra" low ESR for applications in the communications market. Max ESR and effective capacitance

are met on each value producing lot to lot uniformity. Sizes available are EIA chip sizes 0603, 0805, and 1210.

DIMENSIONS: inches (millimeters)

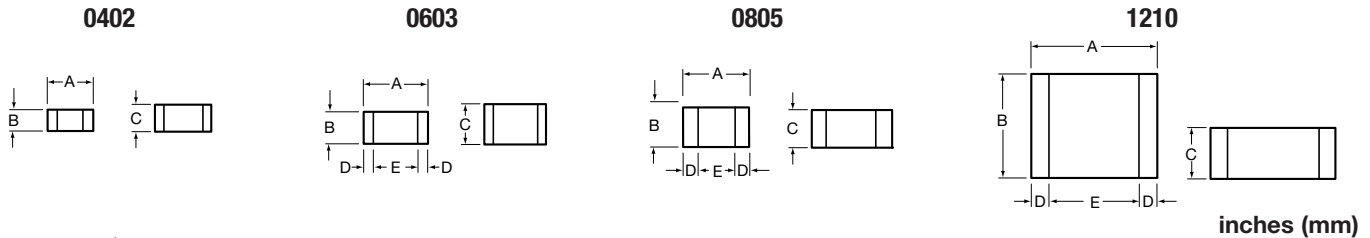

| Size | A | B | C | D | E |
|------|-------------------------|-------------------------|--------------------------|---------------------------|------------------|
| 0402 | 0.039±0.004 (1.00±0.1) | 0.020±0.004 (0.50±0.1) | 0.024 (0.6) max | N/A | N/A |
| 0603 | 0.060±0.010 (1.52±0.25) | 0.030±0.010 (0.76±0.25) | 0.036 (0.91) max | 0.010±0.005 (0.25±0.13) | 0.030 (0.76) min |
| 0805 | 0.079±0.008 (2.01±0.2) | 0.049±0.008 (1.25±0.2) | 0.040±0.005 (1.02±0.127) | 0.020±0.010 (0.51±0.254) | 0.020 (0.51) min |
| 1210 | 0.126±0.008 (3.2±0.2) | 0.098±0.008 (2.49±0.2) | 0.050±0.005 (1.27±0.127) | 0.025±0.015 (0.635±0.381) | 0.040 (1.02) min |

HOW TO ORDER

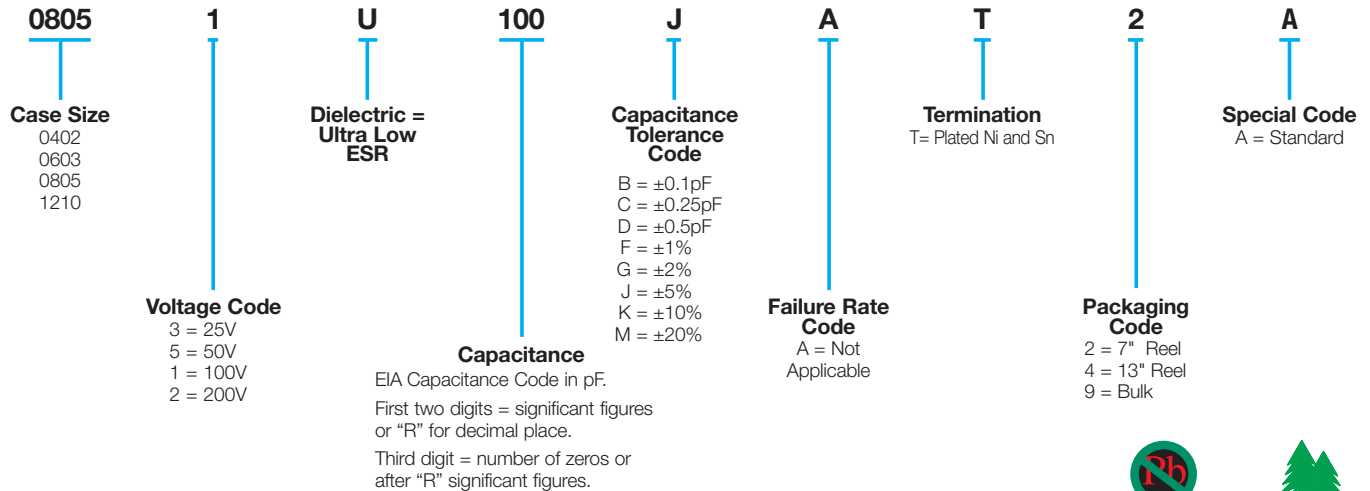

ELECTRICAL CHARACTERISTICS

Capacitance Values and Tolerances:

- Size 0402 - 0.2 pF to 22 pF @ 1 MHz
- Size 0603 - 1.0 pF to 100 pF @ 1 MHz
- Size 0805 - 1.6 pF to 160 pF @ 1 MHz
- Size 1210 - 2.4 pF to 1000 pF @ 1 MHz

Temperature Coefficient of Capacitance (TC):

0±30 ppm/°C (-55° to +125°C)

Insulation Resistance (IR):

- 10¹² Ω min. @ 25°C and rated WVDC
- 10¹¹ Ω min. @ 125°C and rated WVDC

Working Voltage (WVDC):

- | Size | Working Voltage |
|------|-------------------|
| 0402 | 50, 25 WVDC |
| 0603 | 200, 100, 50 WVDC |
| 0805 | 200, 100 WVDC |
| 1210 | 200, 100 WVDC |

Dielectric Working Voltage (DWV):

250% of rated WVDC

Equivalent Series Resistance Typical (ESR):

- 0402 - See Performance Curve, page 231
- 0603 - See Performance Curve, page 231
- 0805 - See Performance Curve, page 231
- 1210 - See Performance Curve, page 231

Marking: Laser marking EIA J marking standard

(except 0603) (capacitance code and tolerance upon request).

MILITARY SPECIFICATIONS

Meets or exceeds the requirements of MIL-C-55681



RF/Microwave C0G (NP0) Capacitors (RoHS)



Ultra Low ESR, "U" Series, C0G (NP0) Chip Capacitors

CAPACITANCE RANGE

| Cap (pF) | Available Tolerance | Size | | | | Cap (pF) | Available Tolerance | Size | | | | Cap (pF) | Available Tolerance | Size | | | | Cap (pF) | Available Tolerance | Size | | | | |
|----------|---------------------|------|------|------|------|----------|---------------------|------|------|------|------|----------|---------------------|------|------|------|------|----------|---------------------|------|------|------|------|---|
| | | 0402 | 0603 | 0805 | 1210 | | | 0402 | 0603 | 0805 | 1210 | | | 0402 | 0603 | 0805 | 1210 | | | 0402 | 0603 | 0805 | 1210 | |
| 0.2 | B,C | 50V | N/A | N/A | N/A | 1.0 | B,C,D | 50V | 200V | 200V | 200V | 100 | F,G,J,K,M | N/A | 100V | 200V | 200V | 100 | F,G,J,K,M | N/A | 100V | 200V | 200V | |
| 0.3 | B,C | ↓ | ↓ | ↓ | ↓ | 1.1 | ↓ | ↓ | ↓ | ↓ | ↓ | 110 | ↓ | ↓ | ↓ | ↓ | ↓ | ↓ | ↓ | ↓ | ↓ | ↓ | ↓ | ↓ |
| 0.4 | B,C | ↓ | ↓ | ↓ | ↓ | 1.2 | ↓ | ↓ | ↓ | ↓ | ↓ | 120 | ↓ | ↓ | ↓ | ↓ | ↓ | ↓ | ↓ | ↓ | ↓ | ↓ | ↓ | ↓ |
| 0.5 | B,C | ↓ | ↓ | ↓ | ↓ | 1.3 | ↓ | ↓ | ↓ | ↓ | ↓ | 130 | ↓ | ↓ | ↓ | ↓ | ↓ | ↓ | ↓ | ↓ | ↓ | ↓ | ↓ | ↓ |
| 0.6 | B,C,D | ↓ | ↓ | ↓ | ↓ | 1.4 | ↓ | ↓ | ↓ | ↓ | ↓ | 140 | ↓ | ↓ | ↓ | ↓ | ↓ | ↓ | ↓ | ↓ | ↓ | ↓ | ↓ | ↓ |
| 0.7 | B,C,D | ↓ | ↓ | ↓ | ↓ | 1.5 | ↓ | ↓ | ↓ | ↓ | ↓ | 150 | ↓ | ↓ | ↓ | ↓ | ↓ | ↓ | ↓ | ↓ | ↓ | ↓ | ↓ | ↓ |
| 0.8 | B,C,D | ↓ | ↓ | ↓ | ↓ | 1.6 | ↓ | ↓ | ↓ | ↓ | ↓ | 160 | ↓ | ↓ | ↓ | ↓ | ↓ | ↓ | ↓ | ↓ | ↓ | ↓ | ↓ | ↓ |
| 0.9 | B,C,D | ↓ | ↓ | ↓ | ↓ | 1.7 | ↓ | ↓ | ↓ | ↓ | ↓ | 180 | ↓ | ↓ | ↓ | ↓ | ↓ | ↓ | ↓ | ↓ | ↓ | ↓ | ↓ | ↓ |
| | | | | | | 1.8 | ↓ | ↓ | ↓ | ↓ | ↓ | 200 | ↓ | ↓ | ↓ | ↓ | ↓ | ↓ | ↓ | ↓ | ↓ | ↓ | ↓ | ↓ |
| | | | | | | 1.9 | ↓ | ↓ | ↓ | ↓ | ↓ | 220 | ↓ | ↓ | ↓ | ↓ | ↓ | ↓ | ↓ | ↓ | ↓ | ↓ | ↓ | ↓ |
| | | | | | | 2.0 | ↓ | ↓ | ↓ | ↓ | ↓ | 270 | ↓ | ↓ | ↓ | ↓ | ↓ | ↓ | ↓ | ↓ | ↓ | ↓ | ↓ | ↓ |
| | | | | | | 2.1 | ↓ | ↓ | ↓ | ↓ | ↓ | 300 | ↓ | ↓ | ↓ | ↓ | ↓ | ↓ | ↓ | ↓ | ↓ | ↓ | ↓ | ↓ |
| | | | | | | 2.2 | ↓ | ↓ | ↓ | ↓ | ↓ | 330 | ↓ | ↓ | ↓ | ↓ | ↓ | ↓ | ↓ | ↓ | ↓ | ↓ | ↓ | ↓ |
| | | | | | | 2.4 | ↓ | ↓ | ↓ | ↓ | ↓ | 360 | ↓ | ↓ | ↓ | ↓ | ↓ | ↓ | ↓ | ↓ | ↓ | ↓ | ↓ | ↓ |
| | | | | | | 2.7 | ↓ | ↓ | ↓ | ↓ | ↓ | 390 | ↓ | ↓ | ↓ | ↓ | ↓ | ↓ | ↓ | ↓ | ↓ | ↓ | ↓ | ↓ |
| | | | | | | 3.0 | ↓ | ↓ | ↓ | ↓ | ↓ | 430 | ↓ | ↓ | ↓ | ↓ | ↓ | ↓ | ↓ | ↓ | ↓ | ↓ | ↓ | ↓ |
| | | | | | | 3.3 | ↓ | ↓ | ↓ | ↓ | ↓ | 470 | ↓ | ↓ | ↓ | ↓ | ↓ | ↓ | ↓ | ↓ | ↓ | ↓ | ↓ | ↓ |
| | | | | | | 3.6 | ↓ | ↓ | ↓ | ↓ | ↓ | 510 | ↓ | ↓ | ↓ | ↓ | ↓ | ↓ | ↓ | ↓ | ↓ | ↓ | ↓ | ↓ |
| | | | | | | 3.9 | ↓ | ↓ | ↓ | ↓ | ↓ | 560 | ↓ | ↓ | ↓ | ↓ | ↓ | ↓ | ↓ | ↓ | ↓ | ↓ | ↓ | ↓ |
| | | | | | | 4.3 | ↓ | ↓ | ↓ | ↓ | ↓ | 620 | ↓ | ↓ | ↓ | ↓ | ↓ | ↓ | ↓ | ↓ | ↓ | ↓ | ↓ | ↓ |
| | | | | | | 4.7 | ↓ | ↓ | ↓ | ↓ | ↓ | 680 | ↓ | ↓ | ↓ | ↓ | ↓ | ↓ | ↓ | ↓ | ↓ | ↓ | ↓ | ↓ |
| | | | | | | 5.1 | ↓ | ↓ | ↓ | ↓ | ↓ | 750 | ↓ | ↓ | ↓ | ↓ | ↓ | ↓ | ↓ | ↓ | ↓ | ↓ | ↓ | ↓ |
| | | | | | | 5.6 | ↓ | ↓ | ↓ | ↓ | ↓ | 820 | ↓ | ↓ | ↓ | ↓ | ↓ | ↓ | ↓ | ↓ | ↓ | ↓ | ↓ | ↓ |
| | | | | | | 6.2 | B,C,D | ↓ | ↓ | ↓ | ↓ | 910 | ↓ | ↓ | ↓ | ↓ | ↓ | ↓ | ↓ | ↓ | ↓ | ↓ | ↓ | ↓ |
| | | | | | | 6.8 | B,C,J,K,M | ↓ | ↓ | ↓ | ↓ | 1000 | F,G,J,K,M | ↓ | ↓ | ↓ | ↓ | ↓ | ↓ | ↓ | ↓ | ↓ | ↓ | ↓ |

ULTRA LOW ESR, "U" SERIES

TYPICAL ESR vs. FREQUENCY
0402 "U" SERIES

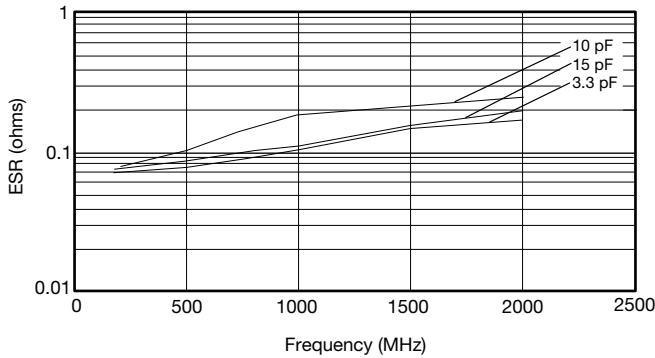

TYPICAL ESR vs. FREQUENCY
0603 "U" SERIES

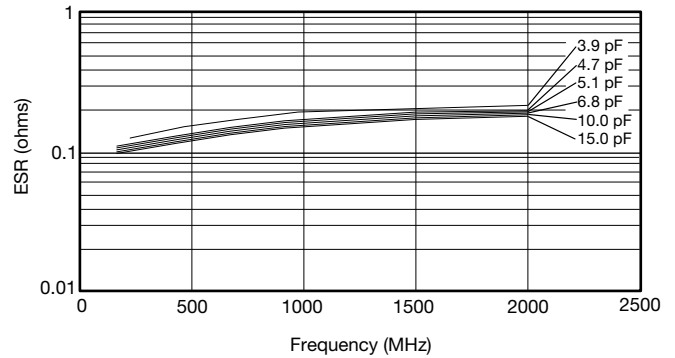

TYPICAL ESR vs. FREQUENCY
0805 "U" SERIES

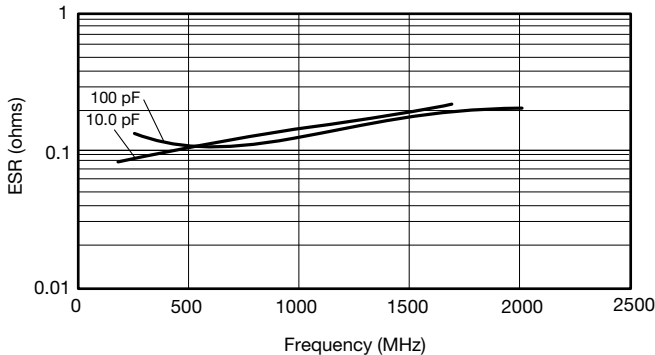

TYPICAL ESR vs. FREQUENCY
1210 "U" SERIES

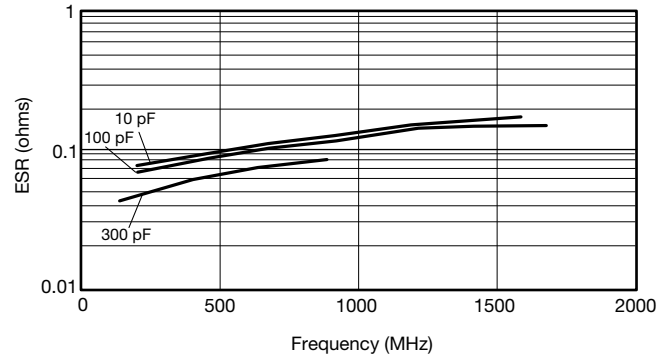

ESR Measured on the Boonton 34A

RF/Microwave C0G (NP0) Capacitors (RoHS)



Ultra Low ESR, "U" Series, C0G (NP0) Chip Capacitors

TYPICAL
SERIES RESONANT FREQUENCY
"U" SERIES CHIP

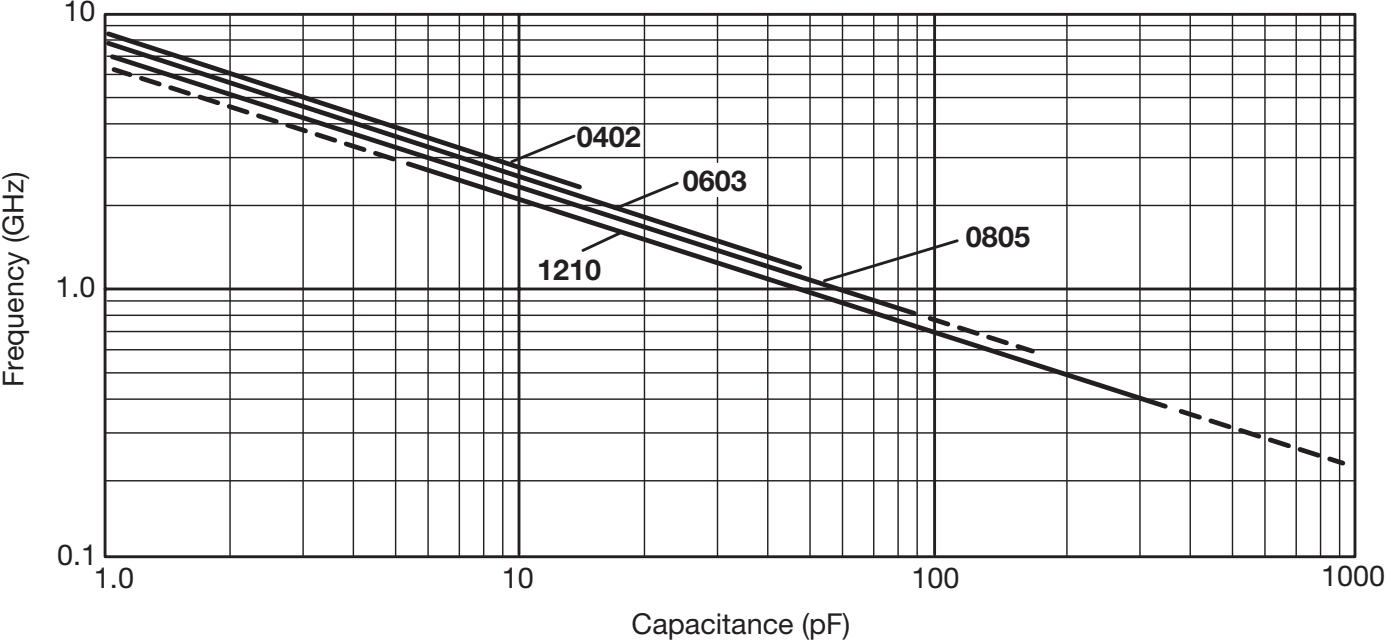

RF/Microwave Automotive C0G (NP0) Capacitors (RoHS), AEC Q200 Qualified



Ultra Low ESR, "U" Series, C0G (NP0) Chip Capacitors

GENERAL INFORMATION

Automotive "U" Series capacitors are C0G (NP0) chip capacitors specially designed for "Ultra" low ESR for applications in the automotive market. Max ESR and effective capacitance

are met on each value producing lot to lot uniformity. Sizes available are EIA chip sizes 0402 and 0603.

DIMENSIONS: inches (millimeters)

0402

0603



| Size | A | B | C | D | E |
|------|-------------------------|-------------------------|------------------|-------------------------|------------------|
| 0402 | 0.039±0.004 (1.00±0.1) | 0.020±0.004 (0.50±0.1) | 0.024 (0.6) max | N/A | N/A |
| 0603 | 0.060±0.010 (1.52±0.25) | 0.030±0.010 (0.76±0.25) | 0.036 (0.91) max | 0.010±0.005 (0.25±0.13) | 0.030 (0.76) min |

inches (mm)

HOW TO ORDER

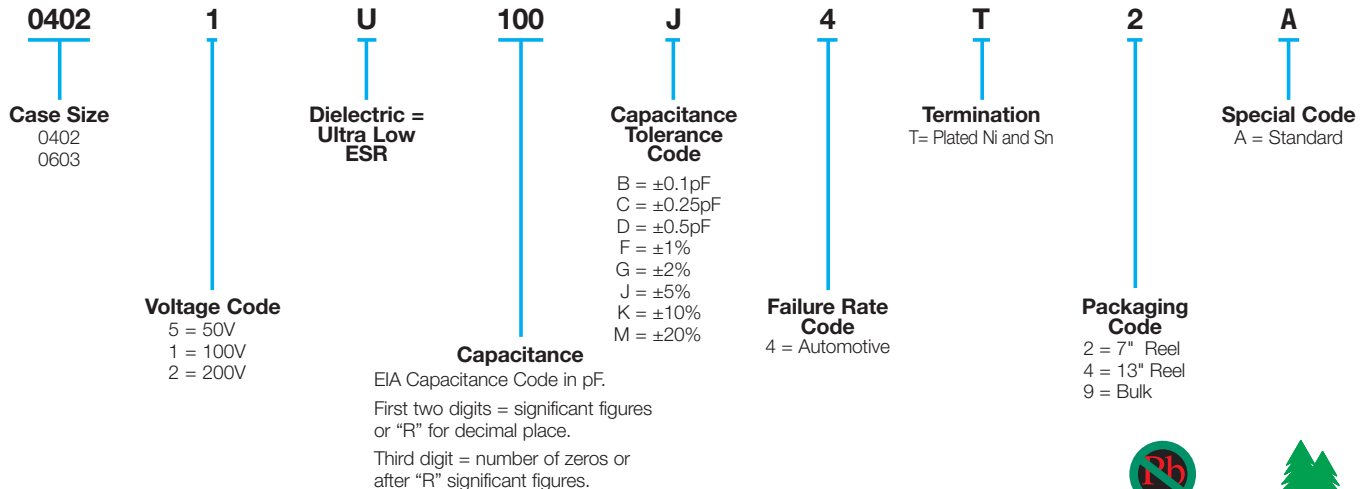

ELECTRICAL CHARACTERISTICS

Capacitance Values and Tolerances:

Size 0402 - 0.2 pF to 22 pF @ 1 MHz
Size 0603 - 1.0 pF to 100 pF @ 1 MHz

Temperature Coefficient of Capacitance (TC):

0±30 ppm/°C (-55° to +125°C)

Insulation Resistance (IR):

10¹² Ω min. @ 25°C and rated WVDC
10¹¹ Ω min. @ 125°C and rated WVDC

Working Voltage (WVDC):

Size Working Voltage
0402 - 50, 25 WVDC
0603 - 200, 100, 50 WVDC

Dielectric Working Voltage (DWV):

250% of rated WVDC

Equivalent Series Resistance Typical (ESR):

0402 - See Performance Curve, page 234
0603 - See Performance Curve, page 234

Automotive Specifications

Meets or exceeds the requirements of AEC Q200



RF/Microwave Automotive C0G (NP0) Capacitors (RoHS), AEC Q200 Qualified



Ultra Low ESR, "U" Series, C0G (NP0) Chip Capacitors

CAPACITANCE RANGE

| Cap (pF) | Available Tolerance | Size | |
|----------|---------------------|------|------|
| | | 0402 | 0603 |
| 0.2 | B,C | 50V | N/A |
| 0.3 | ↓ B,C | ↓ | ↓ |
| 0.4 | | | |
| 0.5 | B,C | ↓ | ↓ |
| 0.6 | B,C,D | ↓ | ↓ |
| 0.7 | ↓ B,C,D | ↓ | ↓ |
| 0.8 | | | |
| 0.9 | B,C,D | ↓ | ↓ |

| Cap (pF) | Available Tolerance | Size | |
|----------|---------------------|------|------|
| | | 0402 | 0603 |
| 1.0 | B,C,D | 50V | 200V |
| 1.1 | ↓ | ↓ | ↓ |
| 1.2 | | | |
| 1.3 | ↓ | ↓ | ↓ |
| 1.4 | | | |
| 1.5 | ↓ | ↓ | ↓ |
| 1.6 | | | |
| 1.7 | ↓ | ↓ | ↓ |
| 1.8 | | | |
| 1.9 | ↓ | ↓ | ↓ |
| 2.0 | | | |
| 2.1 | ↓ | ↓ | ↓ |
| 2.2 | | | |
| 2.4 | ↓ | ↓ | ↓ |
| 2.7 | | | |
| 3.0 | ↓ | ↓ | ↓ |
| 3.3 | | | |
| 3.6 | ↓ | ↓ | ↓ |
| 3.9 | | | |
| 4.3 | ↓ | ↓ | ↓ |
| 4.7 | | | |
| 5.1 | ↓ | ↓ | ↓ |
| 5.6 | | | |
| 6.2 | B,C,D | ↓ | ↓ |
| 6.8 | B,C,J,K,M | ↓ | ↓ |

| Cap (pF) | Available Tolerance | Size | |
|----------|---------------------|------|------|
| | | 0402 | 0603 |
| 7.5 | B,C,J,K,M | 50V | 200V |
| 8.2 | ↓ | ↓ | ↓ |
| 9.1 | | | |
| 10 | B,C,J,K,M | ↓ | ↓ |
| 11 | ↓ | ↓ | ↓ |
| 12 | | | |
| 13 | ↓ | ↓ | ↓ |
| 15 | | | |
| 18 | ↓ | ↓ | ↓ |
| 20 | | | |
| 22 | ↓ | ↓ | ↓ |
| 24 | | | |
| 27 | ↓ | ↓ | ↓ |
| 30 | | | |
| 33 | ↓ | ↓ | ↓ |
| 36 | | | |
| 39 | ↓ | ↓ | ↓ |
| 43 | | | |
| 47 | ↓ | ↓ | ↓ |
| 51 | | | |
| 56 | ↓ | ↓ | ↓ |
| 68 | | | |
| 75 | ↓ | ↓ | ↓ |
| 82 | | | |
| 91 | ↓ | ↓ | ↓ |

| Cap (pF) | Available Tolerance | Size | |
|----------|---------------------|------|------|
| | | 0402 | 0603 |
| 100 | F,G,J,K,M | N/A | 100V |
| 110 | ↓ | ↓ | ↓ |
| 120 | | | |
| 130 | ↓ | ↓ | ↓ |
| 140 | | | |
| 150 | ↓ | ↓ | ↓ |
| 160 | | | |
| 180 | ↓ | ↓ | ↓ |
| 200 | | | |
| 220 | ↓ | ↓ | ↓ |
| 270 | | | |
| 300 | ↓ | ↓ | ↓ |
| 330 | | | |
| 360 | ↓ | ↓ | ↓ |
| 390 | | | |
| 430 | ↓ | ↓ | ↓ |
| 470 | | | |
| 510 | ↓ | ↓ | ↓ |
| 560 | | | |
| 620 | ↓ | ↓ | ↓ |
| 680 | | | |
| 750 | ↓ | ↓ | ↓ |
| 820 | | | |
| 910 | ↓ | ↓ | ↓ |
| 1000 | | | |

ULTRA LOW ESR, "U" SERIES

TYPICAL ESR vs. FREQUENCY
0402 "U" SERIES

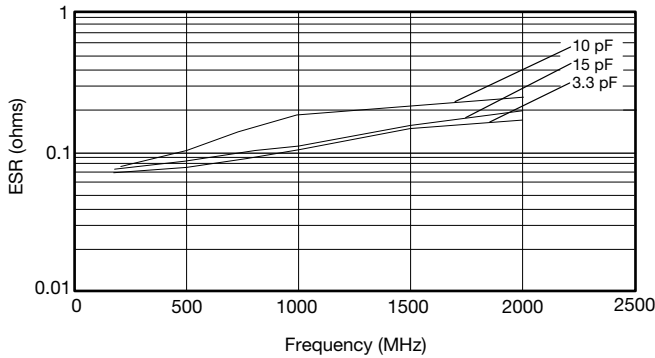

TYPICAL ESR vs. FREQUENCY
0603 "U" SERIES

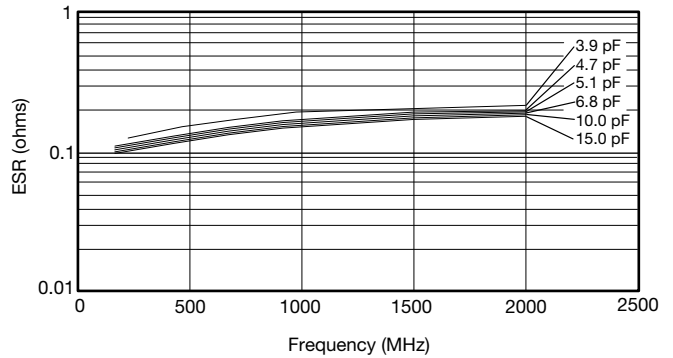

6

RF/Microwave Automotive C0G (NP0) Capacitors (RoHS), AEC Q200 Qualified



Ultra Low ESR, "U" Series, C0G (NP0) Chip Capacitors

TYPICAL
SERIES RESONANT FREQUENCY
"U" SERIES CHIP

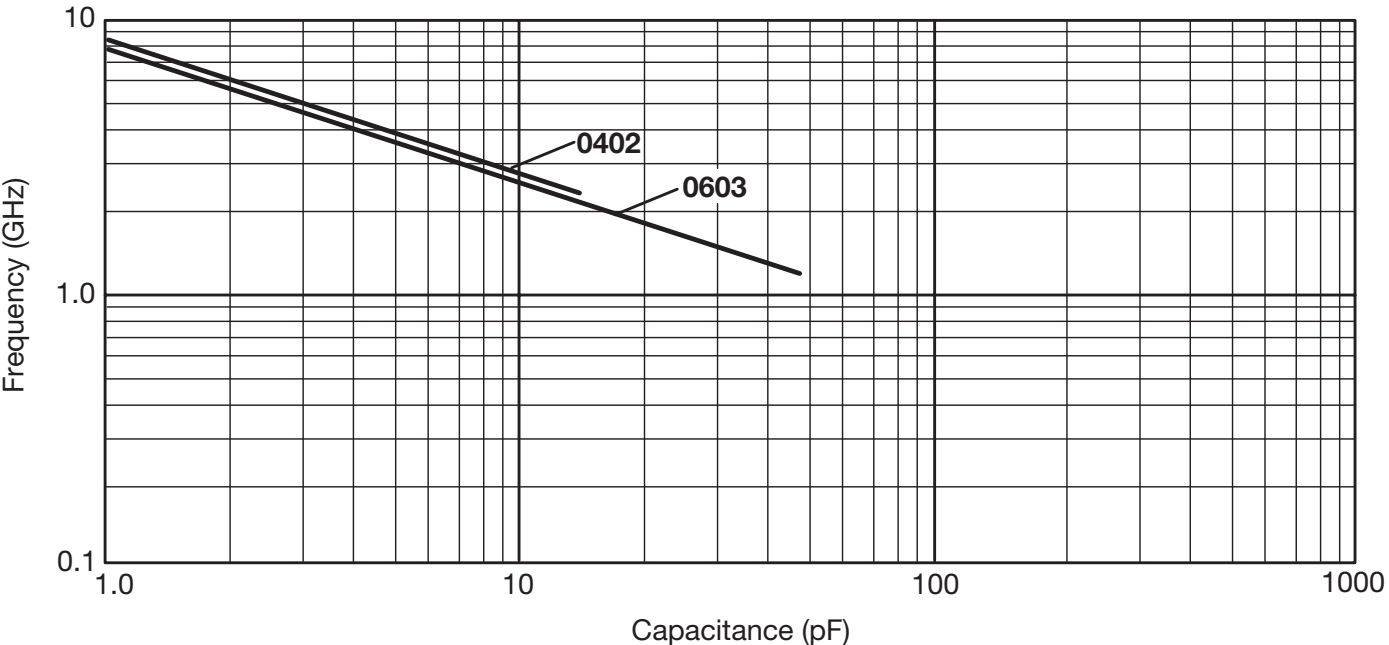

RF/Microwave C0G (NP0) Capacitors (Sn/Pb)



Ultra Low ESR, "U" Series, C0G (NP0) Chip Capacitors

GENERAL INFORMATION

"U" Series capacitors are C0G (NP0) chip capacitors specially designed for "Ultra" low ESR for applications in the communications market. Max ESR and effective capacitance

are met on each value producing lot to lot uniformity. Sizes available are EIA chip sizes 0603, 0805, and 1210.

DIMENSIONS: inches (millimeters)

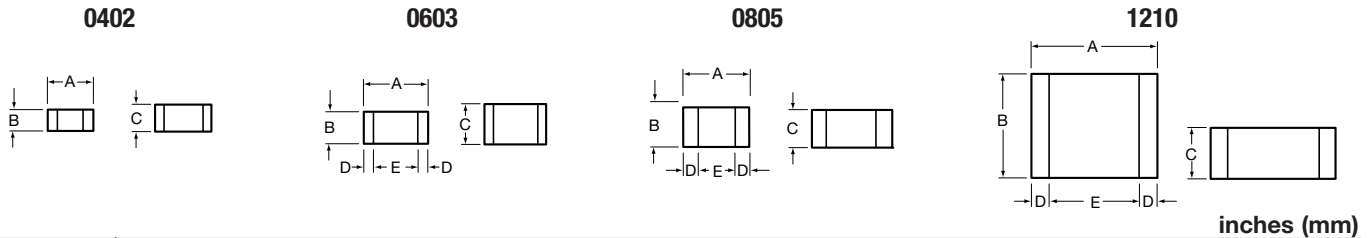

| Size | A | B | C | D | E |
|------|-------------------------|-------------------------|--------------------------|---------------------------|------------------|
| 0402 | 0.039±0.004 (1.00±0.1) | 0.020±0.004 (0.50±0.1) | 0.024 (0.6) max | N/A | N/A |
| 0603 | 0.060±0.010 (1.52±0.25) | 0.030±0.010 (0.76±0.25) | 0.036 (0.91) max | 0.010±0.005 (0.25±0.13) | 0.030 (0.76) min |
| 0805 | 0.079±0.008 (2.01±0.2) | 0.049±0.008 (1.25±0.2) | 0.040±0.005 (1.02±0.127) | 0.020±0.010 (0.51±0.254) | 0.020 (0.51) min |
| 1210 | 0.126±0.008 (3.2±0.2) | 0.098±0.008 (2.49±0.2) | 0.050±0.005 (1.27±0.127) | 0.025±0.015 (0.635±0.381) | 0.040 (1.02) min |

HOW TO ORDER

LD05 | **1** | **U** | **100** | **J** | **A** | **B** | **2** | **A**

- Case Size**
LD02 = 0402
LD03 = 0603
LD05 = 0805
LD10 = 1210
- Voltage Code**
3 = 25V
5 = 50V
1 = 100V
2 = 200V
- Dielectric = Ultra Low ESR**
- Capacitance**
EIA Capacitance Code in pF.
First two digits = significant figures or "R" for decimal place.
Third digit = number of zeros or after "R" significant figures.
- Capacitance Tolerance Code**
B = ±0.1pF
C = ±0.25pF
D = ±0.5pF
F = ±1%
G = ±2%
J = ±5%
K = ±10%
M = ±20%
- Failure Rate Code**
A = Not Applicable
- Termination**
B = 5% min lead
- Packaging Code**
2 = 7" Reel
4 = 13" Reel
9 = Bulk
- Special Code**
A = Standard

Not RoHS Compliant

ELECTRICAL CHARACTERISTICS

Capacitance Values and Tolerances:

- Size 0402 - 0.2 pF to 22 pF @ 1 MHz
- Size 0603 - 1.0 pF to 100 pF @ 1 MHz
- Size 0805 - 1.6 pF to 160 pF @ 1 MHz
- Size 1210 - 2.4 pF to 1000 pF @ 1 MHz

Temperature Coefficient of Capacitance (TC):

0±30 ppm/°C (-55° to +125°C)

Insulation Resistance (IR):

- 10¹² Ω min. @ 25°C and rated WVDC
- 10¹¹ Ω min. @ 125°C and rated WVDC

Working Voltage (WVDC):

- Size Working Voltage
- 0402 - 50, 25 WVDC
- 0603 - 200, 100, 50 WVDC
- 0805 - 200, 100 WVDC
- 1210 - 200, 100 WVDC

Dielectric Working Voltage (DWV):

250% of rated WVDC

Equivalent Series Resistance Typical (ESR):

- 0402 - See Performance Curve, page 237
- 0603 - See Performance Curve, page 237
- 0805 - See Performance Curve, page 237
- 1210 - See Performance Curve, page 237

Marking: Laser marking EIA J marking standard (except 0603) (capacitance code and tolerance upon request).

MILITARY SPECIFICATIONS

Meets or exceeds the requirements of MIL-C-55681



RF/Microwave C0G (NP0) Capacitors (Sn/Pb)



Ultra Low ESR, "U" Series, C0G (NP0) Chip Capacitors

CAPACITANCE RANGE

| Cap (pF) | Available Tolerance | Size | | | |
|----------|---------------------|------|------|------|------|
| | | LD02 | LD03 | LD05 | LD10 |
| 0.2 | B,C | 50V | N/A | N/A | N/A |
| 0.3 | | | | | |
| 0.4 | | | | | |
| 0.5 | B,C | | | | |
| 0.6 | B,C,D | | | | |
| 0.7 | | | | | |
| 0.8 | | | | | |
| 0.9 | B,C,D | | | | |

| Cap (pF) | Available Tolerance | Size | | | |
|----------|---------------------|------|------|------|------|
| | | LD02 | LD03 | LD05 | LD10 |
| 1.0 | B,C,D | 50V | 200V | 200V | 200V |
| 1.1 | | | | | |
| 1.2 | | | | | |
| 1.3 | | | | | |
| 1.4 | | | | | |
| 1.5 | | | | | |
| 1.6 | | | | | |
| 1.7 | | | | | |
| 1.8 | | | | | |
| 1.9 | | | | | |
| 2.0 | | | | | |
| 2.1 | | | | | |
| 2.2 | | | | | |
| 2.4 | | | | | |
| 2.7 | | | | | |
| 3.0 | | | | | |
| 3.3 | | | | | |
| 3.6 | | | | | |
| 3.9 | | | | | |
| 4.3 | | | | | |
| 4.7 | | | | | |
| 5.1 | | | | | |
| 5.6 | | | | | |
| 6.2 | B,C,D | | | | |
| 6.8 | B,C,J,K,M | | | | |

| Cap (pF) | Available Tolerance | Size | | | |
|----------|---------------------|------|------|------|------|
| | | LD02 | LD03 | LD05 | LD10 |
| 7.5 | B,C,J,K,M | 50V | 200V | 200V | 200V |
| 8.2 | | | | | |
| 9.1 | B,C,J,K,M | | | | |
| 10 | F,G,J,K,M | | | | |
| 11 | | | | | |
| 12 | | | | | |
| 13 | | | | | |
| 15 | | | | | |
| 18 | | | | | |
| 20 | | | | | |
| 22 | | | | | |
| 24 | | | | | |
| 27 | | | | | |
| 30 | | | | | |
| 33 | | | | | |
| 36 | | | | | |
| 39 | | | | | |
| 43 | | | | | |
| 47 | | | | | |
| 51 | | | | | |
| 56 | | | | | |
| 68 | | | | | |
| 75 | | | | | |
| 82 | | | | | |
| 91 | | | | | |

| Cap (pF) | Available Tolerance | Size | | | |
|----------|---------------------|------|------|------|------|
| | | LD02 | LD03 | LD05 | LD10 |
| 100 | F,G,J,K,M | N/A | 100V | 200V | 200V |
| 110 | | | | | |
| 120 | | | | | |
| 130 | | | | | |
| 140 | | | | | |
| 150 | | | | | |
| 160 | | | | | |
| 180 | | | | | |
| 200 | | | | | |
| 220 | | | | | |
| 270 | | | | | |
| 300 | | | | | |
| 330 | | | | | |
| 360 | | | | | |
| 390 | | | | | |
| 430 | | | | | |
| 470 | | | | | |
| 510 | | | | | |
| 560 | | | | | |
| 620 | | | | | |
| 680 | | | | | |
| 750 | | | | | |
| 820 | | | | | |
| 910 | | | | | |
| 1000 | F,G,J,K,M | | | | |

ULTRA LOW ESR, "U" SERIES

TYPICAL ESR vs. FREQUENCY
0402 "U" SERIES

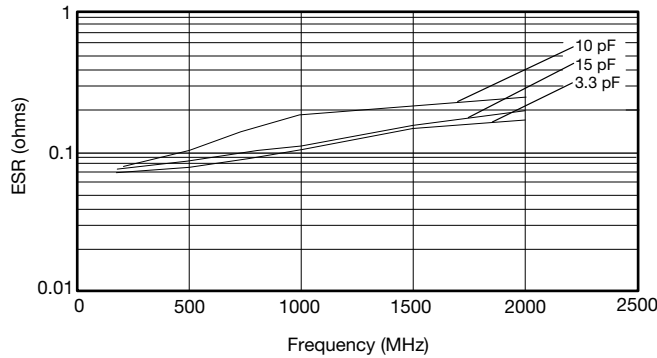

TYPICAL ESR vs. FREQUENCY
0603 "U" SERIES

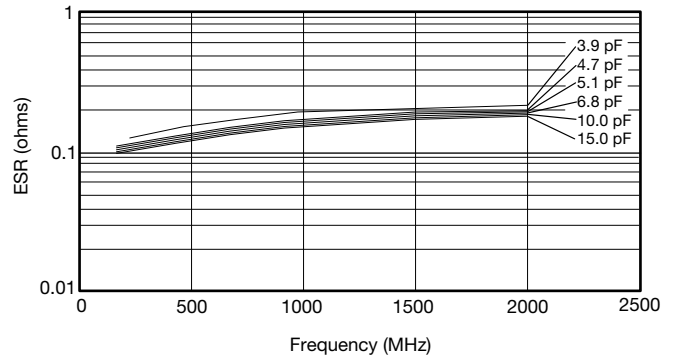

TYPICAL ESR vs. FREQUENCY
0805 "U" SERIES

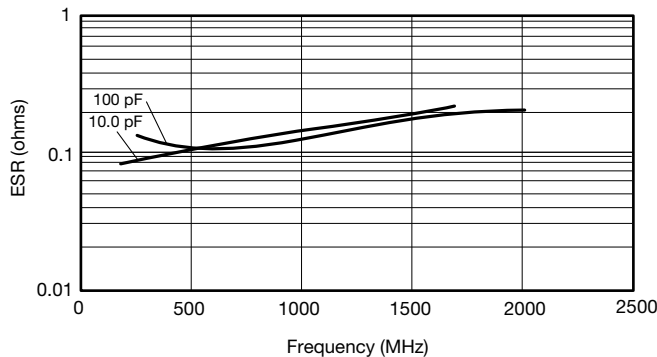

TYPICAL ESR vs. FREQUENCY
1210 "U" SERIES

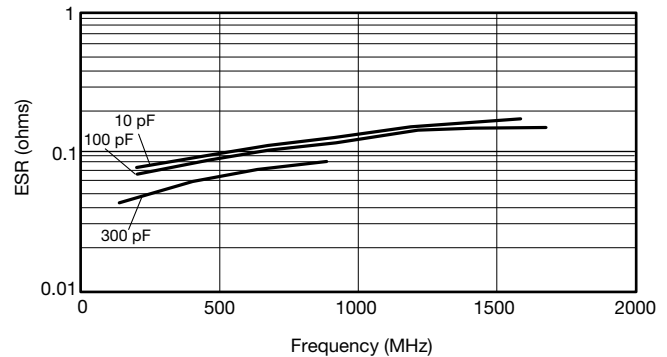

ESR Measured on the Boonton 34A

RF/Microwave C0G (NP0) Capacitors (Sn/Pb)



Ultra Low ESR, "U" Series, C0G (NP0) Chip Capacitors

TYPICAL
SERIES RESONANT FREQUENCY
"U" SERIES CHIP

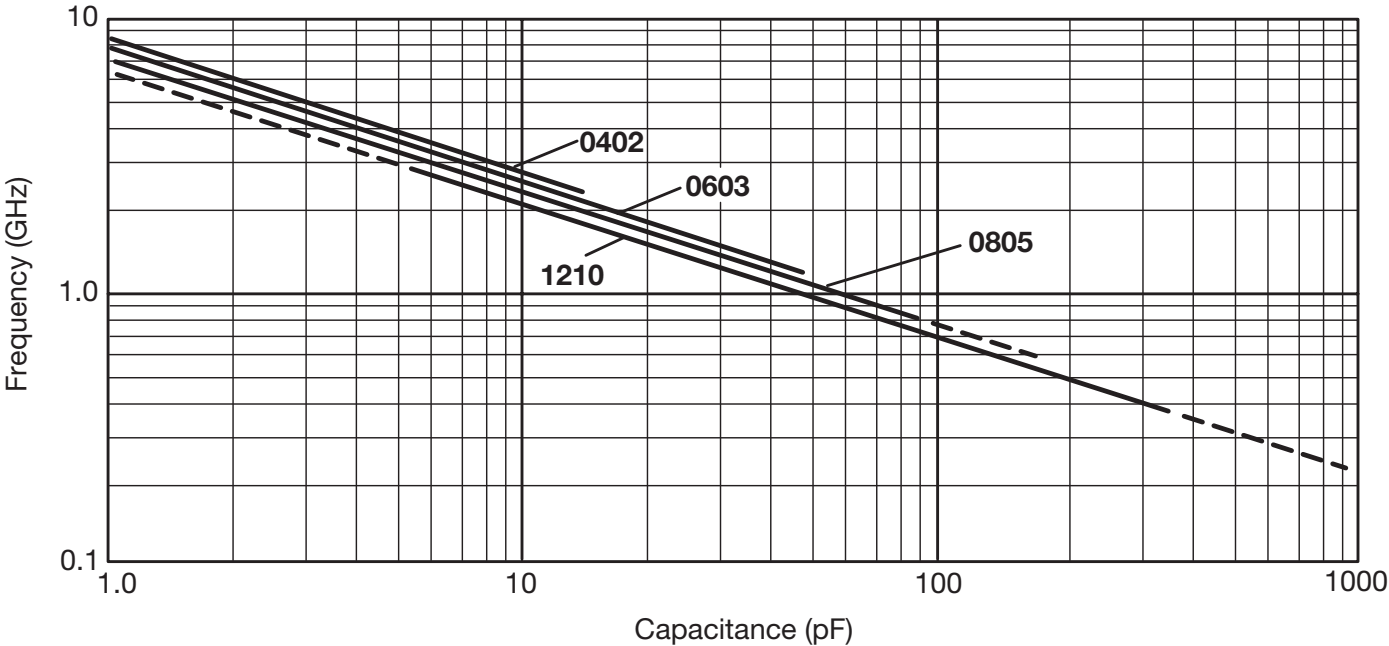

“U” Dielectric Kits

0402

| Kit 5000 UZ | | | |
|---------------|--------------------------|---------------|--------------------------|
| Cap. Value pF | Tolerance | Cap. Value pF | Tolerance |
| 0.5 | B ($\pm 0.1\text{pF}$) | 4.7 | B ($\pm 0.1\text{pF}$) |
| 1.0 | | 5.6 | |
| 1.5 | | 6.8 | |
| 1.8 | | 8.2 | |
| 2.2 | | 10.0 | |
| 2.4 | | 12.0 | |
| 3.0 | J ($\pm 5\%$) | 15.0 | J ($\pm 5\%$) |
| 3.6 | | | |

***25 each of 15 values

0603

| Kit 4000 UZ | | | | |
|---------------|--------------------------|-----------------|--------------------------|-----------------|
| Cap. Value pF | Tolerance | Cap. Value pF | Tolerance | |
| 1.0 | B ($\pm 0.1\text{pF}$) | 6.8 | B ($\pm 0.1\text{pF}$) | |
| 1.2 | | 7.5 | | |
| 1.5 | | 8.2 | | |
| 1.8 | | J ($\pm 5\%$) | 10.0 | J ($\pm 5\%$) |
| 2.0 | | | 12.0 | |
| 2.4 | | | 15.0 | |
| 2.7 | | | 18.0 | |
| 3.0 | | | 22.0 | |
| 3.3 | | | 27.0 | |
| 3.9 | | | 33.0 | |
| 4.7 | | | 39.0 | |
| 5.6 | | | 47.0 | |

***25 each of 24 values

0805

| Kit 3000 UZ | | | |
|---------------|--------------------------|-----------------|-----------------|
| Cap. Value pF | Tolerance | Cap. Value pF | Tolerance |
| 1.0 | B ($\pm 0.1\text{pF}$) | 15.0 | J ($\pm 5\%$) |
| 1.5 | | 18.0 | |
| 2.2 | | 22.0 | |
| 2.4 | | 24.0 | |
| 2.7 | | 27.0 | |
| 3.0 | | 33.0 | |
| 3.3 | | 36.0 | |
| 3.9 | | 39.0 | |
| 4.7 | | 47.0 | |
| 5.6 | | 56.0 | |
| 7.5 | | 68.0 | |
| 8.2 | | 82.0 | |
| 9.1 | | 100.0 | |
| 10.0 | | J ($\pm 5\%$) | |
| 12.0 | 160.0 | | |

***25 each of 30 values

1210

| Kit 3500 UZ | | | | |
|---------------|--------------------------|-----------------|-----------------|-------|
| Cap. Value pF | Tolerance | Cap. Value pF | Tolerance | |
| 2.2 | B ($\pm 0.1\text{pF}$) | 36.0 | J ($\pm 5\%$) | |
| 2.7 | | 39.0 | | |
| 4.7 | | 47.0 | | |
| 5.1 | | 51.0 | | |
| 6.8 | | 56.0 | | |
| 8.2 | | 68.0 | | |
| 9.1 | | 82.0 | | |
| 10.0 | | J ($\pm 5\%$) | | 100.0 |
| 13.0 | 120.0 | | | |
| 15.0 | 130.0 | | | |
| 18.0 | 240.0 | | | |
| 20.0 | 300.0 | | | |
| 24.0 | 390.0 | | | |
| 27.0 | 470.0 | | | |
| 30.0 | 680.0 | | | |

***25 each of 30 values

SOLUTIONS ACROSS THE BOARD

Capacitors

Advanced Power Film
Ceramic
Disc
Film
Glass
High Voltage
Leaded / Through Hole
Low ESR
Low Inductance
Military / Aerospace
MLCC Array
MOS / MIS
Niobium Oxide* (OxiCap®)
RF / Microwave
(Power, Hi Q, Thin-Film)
Single Layer (SLC)
SMPS (Power Supply)
Stacked Ceramic
Supercapacitor (BestCap™)
Tantalum
Tantalum Polymer
Trimmer

Circuit Protection

Fuses (Thin-Film)
MLV (TransGuard™)
MLV Array (MultiGuard™)
NTC Thermistors
Transient Voltage Suppressors
Zinc Oxide Varistors

Filters

EMI (Bolt-In and SMD)
EMI / TVS Filter
Feedthrough
High Current Feedthrough
Low Pass (Thin-Film)
SAW

RF / Microwave

Capacitors
Couplers
Inductors
PMC Custom Filters
Modules
Timing Devices
Passive Micro Components (PMC)
Diplexers
Crossovers

Integrated Passives

IDC (Low Inductance Array)
Passive Thick Film Array
Passive Micro Components (PMC)

Module Devices

Antenna Switch
Bluetooth
LTCC
GPS
RX Module
WLAN Module

Piezo

Acoustic Devices
Actuators

Timing Devices

Ceramic Resonator
Clock Oscillator
Crystal Applied Product
MHz Crystal
SAW Resonator
TCXO

Connectors

2mm Hard Metric
Automotive – Custom
Battery
Board to Board
 1 piece Compression
 2 piece Microleaf
Card Edge
DIN41612
FFC / FPC
IDC
Memory Connectors
 PCMCIA Kits
 Compact Flash
 SO-DIMM
 SIMM / RUM
 SDIO / SD
Military
PCI Express
Varicon Rack and Panel

**For more information please visit
our website at
<http://www.avx.com>**

NOTICE: Specifications are subject to change without notice. Contact your nearest AVX Sales Office for the latest specifications. All statements, information and data given herein are believed to be accurate and reliable, but are presented without guarantee, warranty, or responsibility of any kind, expressed or implied. Statements or suggestions concerning possible use of our products are made without representation or warranty that any such use is free of patent infringement and are not recommendations to infringe any patent. The user should not assume that all safety measures are indicated or that other measures may not be required. Specifications are typical and may not apply to all applications.

© AVX Corporation



AMERICAS

AVX Greenville, SC
Tel: 864-967-2150

EUROPE

AVX Limited, England
Tel: +44-1276-697000

AVX S.A.S., France
Tel: +33-1-69-18-46-00

AVX GmbH, Germany
Tel: +49-0811-95949-0

AVX SRL, Italy
Tel: +39-02-614-571

AVX Czech Republic
Tel: +420-57-57-57-521

AVX/ELCO UK
Tel: +44-1638-675000

ELCO Europe GmbH
Tel: +49-2741-299-0

AVX S.A., Spain
Tel: +34-91-63-97-197

AVX Benelux
Tel: +31-187-489-337

ASIA-PACIFIC

**AVX/Kyocera (S) Pte Ltd.,
Singapore**
Tel: +65-6286-7555

**AVX/Kyocera, Asia, Ltd.,
Hong Kong**
Tel: +852-2363-3303

**AVX/Kyocera Yuhan Hoesa,
South Korea**
Tel: +82-2785-6504

**AVX/Kyocera HK Ltd.,
Taiwan**
Tel: +886-2-2656-0258

**AVX/Kyocera (M) Sdn Bhd,
Malaysia**
Tel: +60-4228-1190

**AVX/Kyocera International
Trading Co. Ltd.,
Shanghai**
Tel: +86-21-3255 1933

**AVX/Kyocera Asia Ltd.,
Shenzen**
Tel: +86-755-3336-0615

**AVX/Kyocera International
Trading Co. Ltd.,
Beijing**
Tel: +86-10-6588-3528

**AVX/Kyocera India
Liaison Office**
Tel: +91-80-6450-0715

ASIA-KED

(KYOCERA Electronic Devices)

KED Hong Kong Ltd.
Tel: +852-2305-1080/1223

**KED Hong Kong Ltd.
Shenzen**
Tel: +86-755-3398-9600

**KED Company Ltd.
Shanghai**
Tel: +86-21-3255-1833

**KED Hong Kong Ltd.
Beijing**
Tel: +86-10-5869-4655

KED Taiwan Ltd.
Tel: +886-2-2950-0268

**KED Korea Yuhan Hoesa,
South Korea**
Tel: +82-2-783-3604/6126

**KED (S) Pte Ltd.
Singapore**
Tel: +65-6509-0328

**Kyocera Corporation
Japan**
Tel: +81-75-604-3449

Contact:



<http://www.avx.com>

S-RFMTF0M416-C