

## Audio Jack Detector and Pop Noise Control Switch

### DESCRIPTION

The DG2591 is an audio jack detector and pop noise control switch IC.

When there is no ear phone detected, the DG2591 connects the microphone bias line to ground through the MIC pin. The DG2591 also gives a logic HIGH signal to the baseband controller through the OUT pin.

The DG2591 senses the DC levels at both L\_Detect and GND\_Detect. When an ear phone is plugged in, the voltage at both pins will go low. The DG2591 will indicate the presence of the ear phone by pulling OUT low and the MIC switch will turn off.

The DG2591 is available ultra small miniQFN6 of 1 mm x 1.2 mm size.

### FEATURES

- Operates with  $1.8\text{ V} \pm 5\%$
- Low quiescent current of  $2\ \mu\text{A}/\text{max}$ .
- Integrated sense comparator for audio L of  $1.4\text{ V} \pm 5\%$  threshold
- $1\ \Omega/\text{max}$ . MIC bias switch provides a quick discharge and clamping
- (Integrated deglitch circuit)
- ESD Protected
  - Human body model  $> 5\text{ kV}$
  - Charged device model  $> 1\text{ kV}$
  - IEC 61000-4-2 air discharge  $> 15\text{ kV}$
  - IEC 61000-4-2 contact discharge  $> 8\text{ kV}$
- Ultra compact miniQFN6 of 1 mm x 1.2 mm
- Material categorization: for definitions of compliance please see [www.vishay.com/doc?99912](http://www.vishay.com/doc?99912)



### APPLICATIONS

- Cellular phones
- Tablet devices
- Portable media players
- Digital cameras

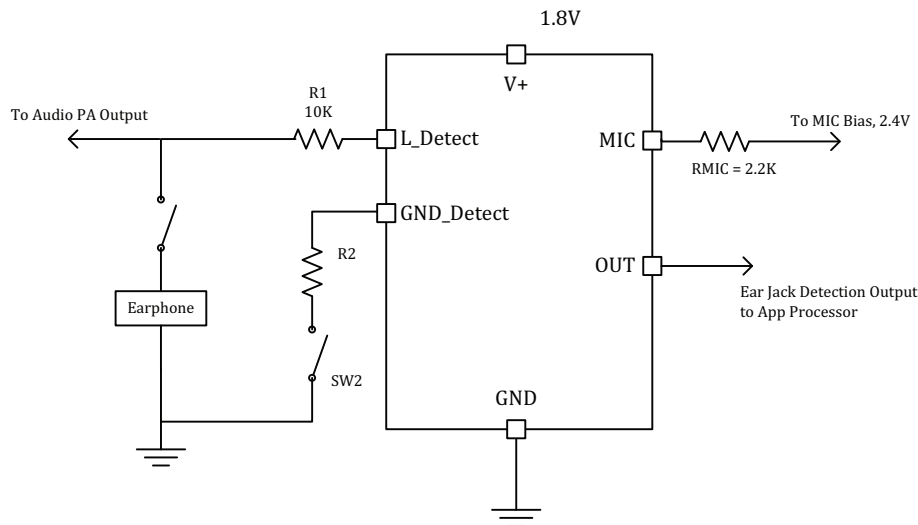
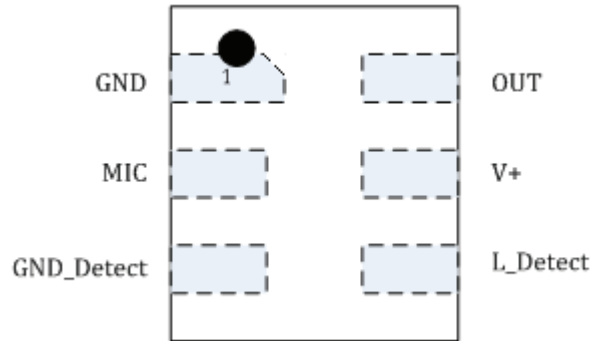
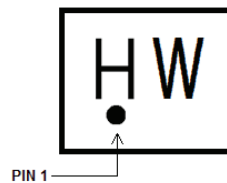

Fig. 1 - Typical Operation Circuit

**PACKAGE OUTLINE**

**Fig. 2 - Device Pin Out miniQFN6 Top View, Pin 1 Dot Marking is on Top of the Device**

PIN DESCRIPTION		
PIN#	NAME	FUNCTION
1	GND	Ground
2	MIC	Microphone bias switch input. Connect to AUXMIC_IN
3	GND_Detect	Connect to ground detect pin at audio jack
4	L_Detect	Connected to L_Detect pin at audio jack
5	V+	Device power supply connected to 1.8 V source
6	OUT	Detect logic output connected to baseband controller

ORDERING INFORMATION		
TEMPERATURE RANGE	PACKAGE	PART NUMBER
-40 °C to 85 °C	miniQFN6	DG2591DN-T1-GE4

**DEVICE MARKING**

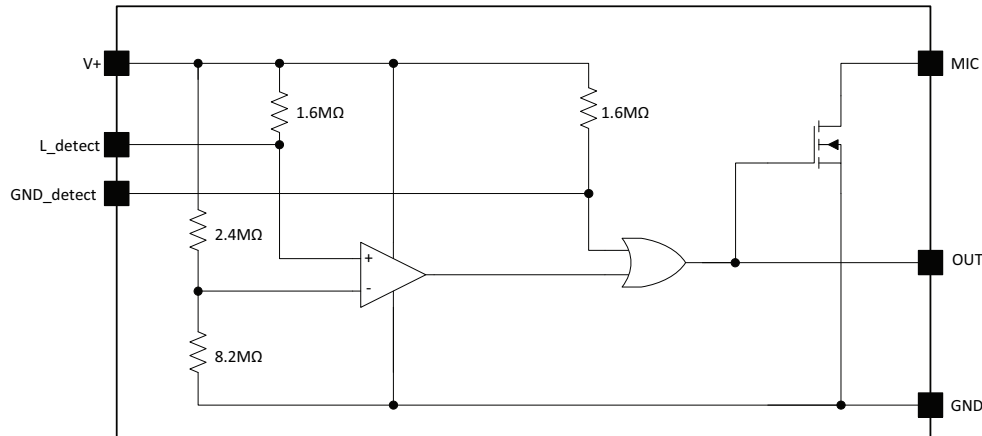
H = DG2591 Marking Code, W = Date/Lot Traceability Code

**Fig. 3 - Functional Block Diagram**

TRUTH TABLE			
L_DETECT	GND_DETECT	OUT	MIC
0	0	Low	High
1	x	High	Low
x	1	High	Low

ABSOLUTE MAXIMUM RATINGS				
PINS OR PARAMETERS	CONDITIONS	LIMITS	UNIT	
V+	Reference to GND	-0.3 to 6	V	
L_Detect, GND_Detect, OUT	Reference to GND	V+		
MIC		-0.3 to 6		
Storage Temperature		-65 to +150	°C	
MSL	Moisture Sensitivity Level (JEDEC® J-STD-020)	1	Level	
I <sub>MIC</sub>	Switch DC current	200	mA	
I <sub>MICPEAK</sub>	Switch peak current (pulsed at 1 ms, < 10 % duty cycle)	500		
Latch up Current per JESD78		500		
ESD	Human body model	> 5	kV	
	IEC 61000-2-4, Level 4, L_Detect, GND_Detect, MIC and GND Pins	Contact		> 8
		Air		> 15
	Charged device model, JESD22-C101	> 1		
RECOMMENDED OPERATING CONDITION				
V+		1.8	V	
Operating Junction Temperature		-40 ~ +125	°C	

**Notes**

- The control logic pins should not float. It should be compliant with either high or low logic
- Negative current injection up to 300 mA

Stresses beyond those listed under "Absolute Maximum Ratings" may cause permanent damage to the device. These are stress ratings only, and functional operation of the device at these or any other conditions beyond those indicated in the operational sections of the specifications is not implied. Exposure to absolute maximum rating conditions for extended periods may affect device reliability.



ELECTRICAL CHARACTERISTICS						
PARAMETER	SYMBOL	TEST CONDITION UNLESS OTHERWISE SPECIFIED, T <sub>A</sub> = -40 °C to 85 °C, TYPICAL VALUES are at 25 °C	LIMITS			UNIT
			MIN.	TYP.	MAX.	
Quiescent Current	I <sub>Q</sub>	V+ = 1.8 V; L_Detect, GND_Detect are open	-	< 1	2	μA
Ear Jack In Current	I <sub>DETECT</sub>	V+ = 1.8 V; L_Detect, GND_Detect are connected with 10 kΩ to GND	-	-	5	
L_Detect Reference Voltage			1.33	1.4	1.47	V
L_Detect Reference Voltage Hysteresis		GND_Detect = 0 V	-	20	-	mV
GND_Detect Logic Low Voltage		V+ = 1.8 V	0.6	0.84	-	V
GND_Detect Logic High Voltage		V+ = 1.8 V	-	-	1.1	
MIC Switch Resistance	R <sub>MIC</sub>	V+ = 1.8 V; I <sub>MIC</sub> = 10 mA L_Detect, GND_Detect = Open	-	-	1	Ω
MIC Leakage		V <sub>MIC</sub> = 2.4 V	-1	-	1	μA
OUT Pull Up Resistance	R <sub>OUTH</sub>	V+ = 1.8 V; L_Detect, GND_Detect = Open	-	-	110	Ω
OUT Pull Down Resistance	R <sub>OUTL</sub>	V+ = 1.8 V; L_Detect, GND_Detect are connected with 10 kΩ to GND,	-	-	100	
OUT High Logic Voltage	V <sub>OUTH</sub>	V+ = 1.8 V; R <sub>OUT</sub> = 10 kΩ L_Detect, GND_Detect = Open	1.6	-	-	V
OUT Low Logic Voltage	V <sub>OUTL</sub>	V+ = 1.8 V; R <sub>OUT</sub> = 10 kΩ L_Detect, GND_Detect are connected with 10 kΩ to GND,	-	-	0.3	
MIC Rising Propagation Delay (insertion detection time)	t <sub>MICR</sub>	From SW1 and SW2 ON, GND_Detect = 0 V, voltage on L_Detect drops to 0.9 V, to the time when MIC rises to 1.2 V and OUT falls below 0.3 V (refer to circuit below, R3 = 10K, C1 = 5 pF, MIC biased at 2.4 V via a 2.2K resistor)	-	1.5	2	μs
MIC Falling Propagation Delay (removal detection time)	t <sub>MICF</sub>	From SW1 and SW2 ON, GND_Detect = 0 V, voltage on L_Detect rises to 0.9 V, to the time when MIC drops to 1.2 V and OUT rises above 0.3 V (refer to circuit below, R3 = 10K, C1 = 5 pF, MIC biased at 2.4 V via a 2.2K resistor)	-	350	500	ns
OUT Falling Propagation Delay	t <sub>OUTF</sub>	From SW1 and SW2 ON, GND_Detect = 0 V, voltage on L_Detect drops to 0.9 V, to the time when MIC rises to 1.2 V and OUT falls below 0.3 V (refer to circuit below, R3 = 10K, C1 = 5 pF, MIC biased at 2.4 V via a 2.2K resistor)	-	1.4	2	μs
OUT Rising Propagation Delay	t <sub>OUTR</sub>	From SW1 and SW2 ON, GND_Detect = 0 V, voltage on L_Detect rises to 0.9 V, to the time when MIC drops to 1.2 V and OUT rises above 0.3 V (refer to circuit below, R3 = 10K, C1 = 5 pF, MIC biased at 2.4 V via a 2.2K resistor)	-	350	500	ns
GND_Detect Capacitance	C <sub>GD</sub>		-	-	5	pF

**TYPICAL CHARACTERISTICS** ( $T_A = 25^\circ\text{C}$ , unless otherwise noted)

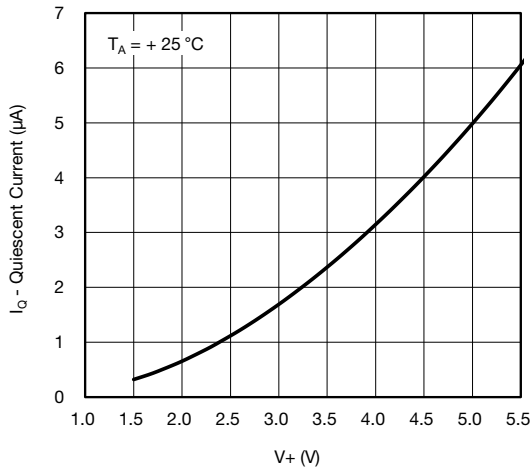

**Quiescent Current vs. V+**

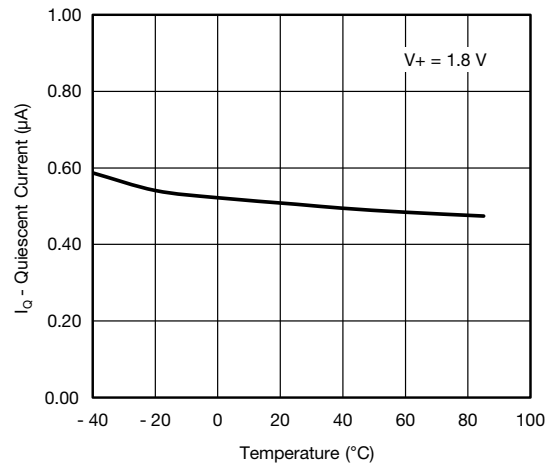

**Quiescent Current vs. Temperature**

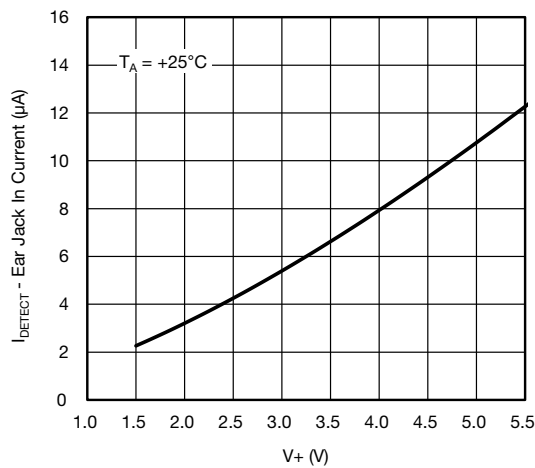

**Ear Jack In Current vs. V+**

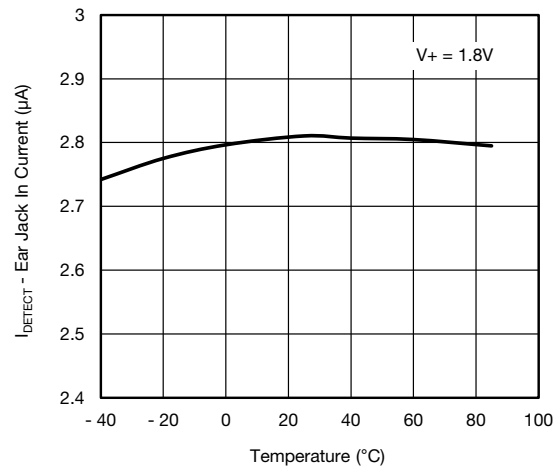

**Ear Jack In Current vs. Temperature**

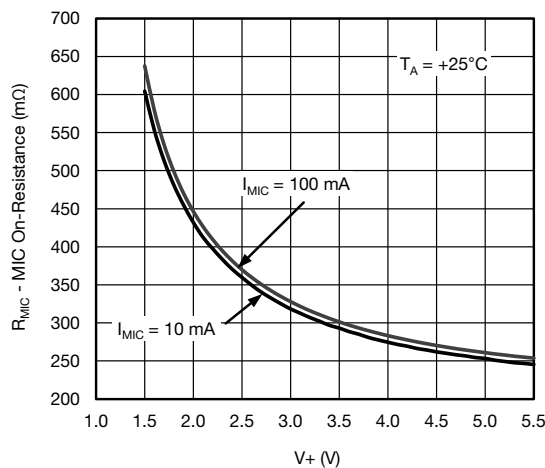

**MIC On Resistance vs. V+**

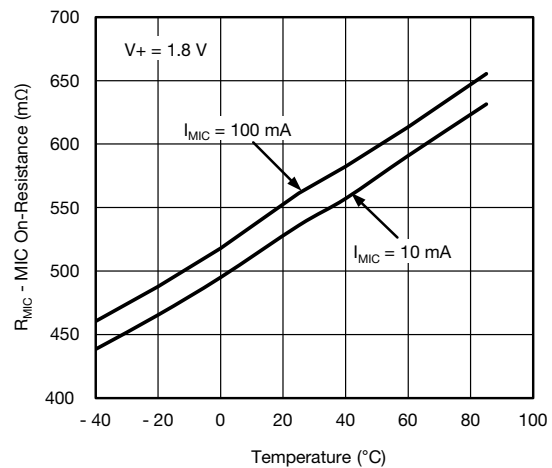

**MIC On Resistance vs. Temperature**



**TYPICAL CHARACTERISTICS** ( $T_A = 25\text{ }^\circ\text{C}$ , unless otherwise noted)

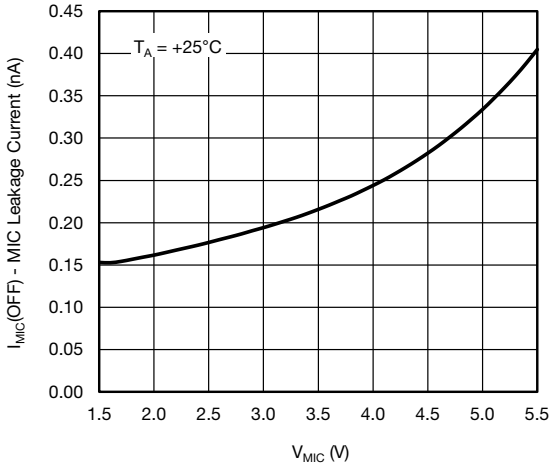

**MIC Leakage Current vs.  $V_{MIC}$**

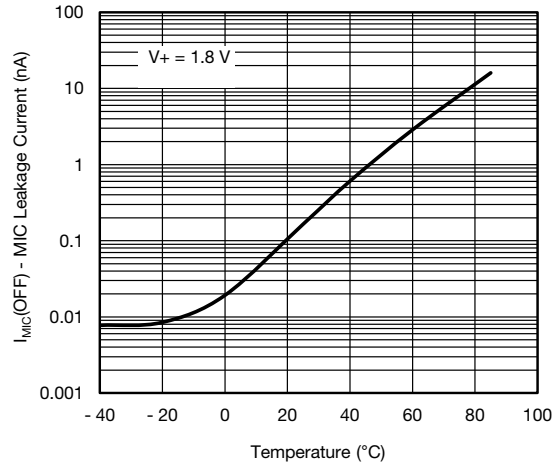

**MIC Leakage Current vs. Temperature**

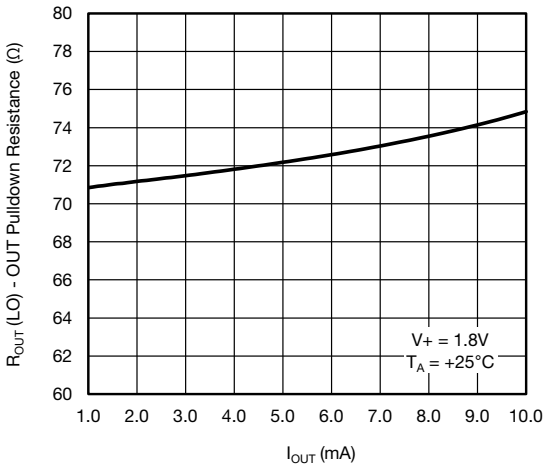

**OUT Pulldown Resistance vs.  $I_{OUT}$**

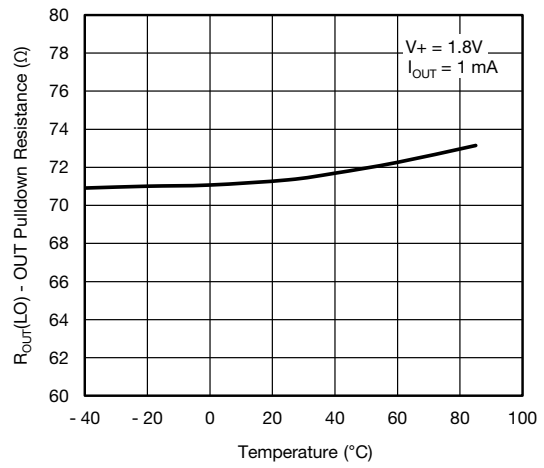

**OUT Pulldown Resistance vs. Temperature**

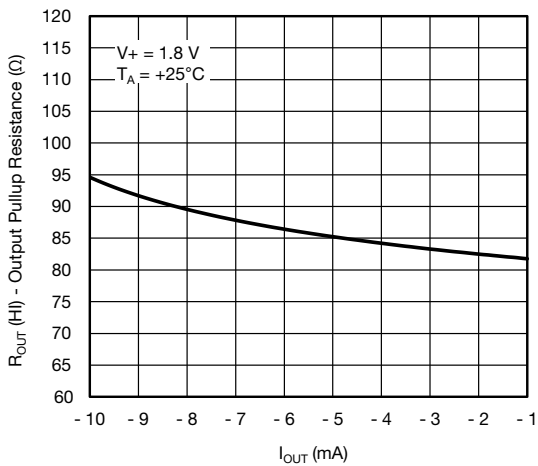

**OUT Pullup Resistance vs.  $I_{OUT}$**

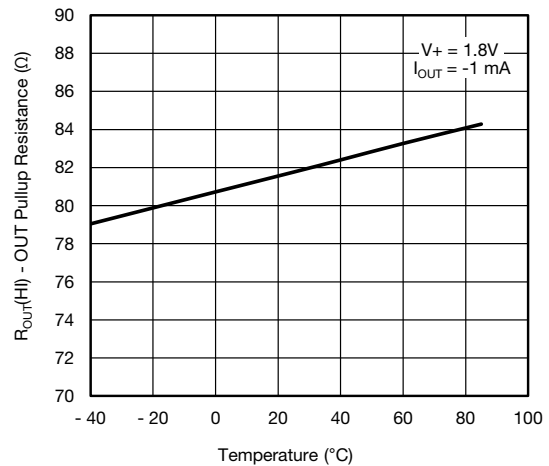

**OUT Pullup Resistance vs. Temperature**



TYPICAL CHARACTERISTICS (T<sub>A</sub> = 25 °C, unless otherwise noted)

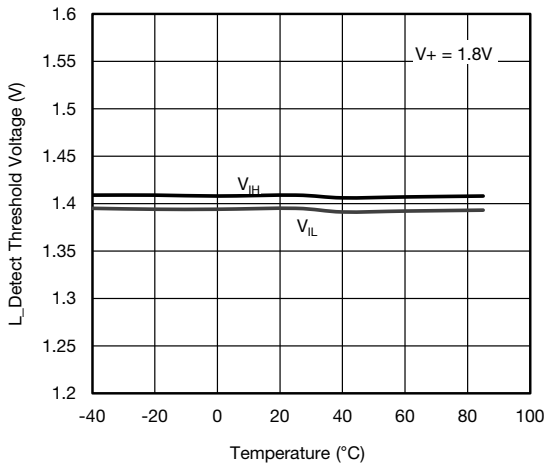

L\_Detect Threshold Voltage vs. Temperature

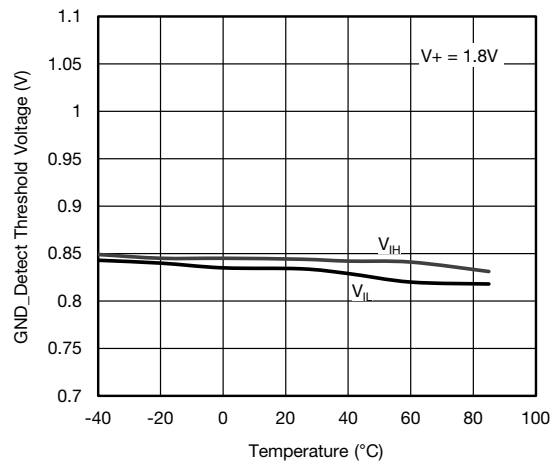

GND\_Detect Threshold Voltage vs. Temperature

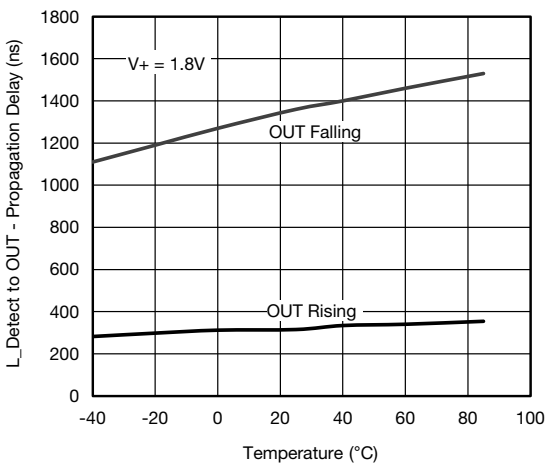

L\_Detect to OUT Propagation Delay vs. Temperature

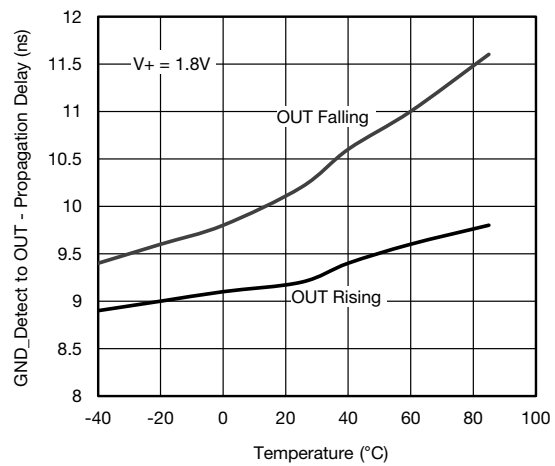

GND\_Detect to OUT Propagation Delay vs. Temperature

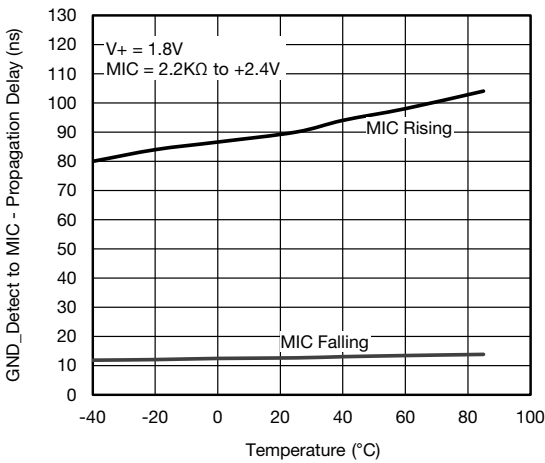

GND\_Detect to MIC Propagation Delay vs. Temperature

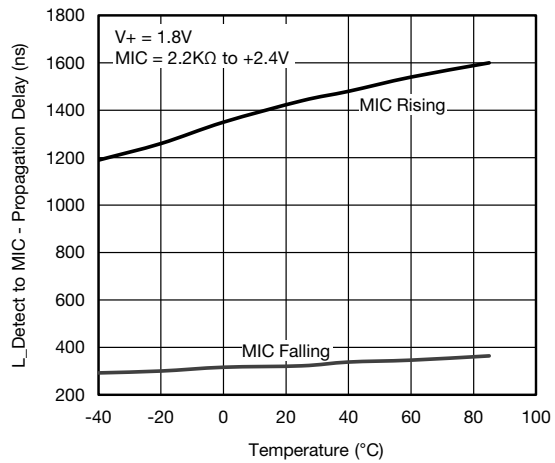

L\_Detect to MIC Propagation Delay vs. Temperature

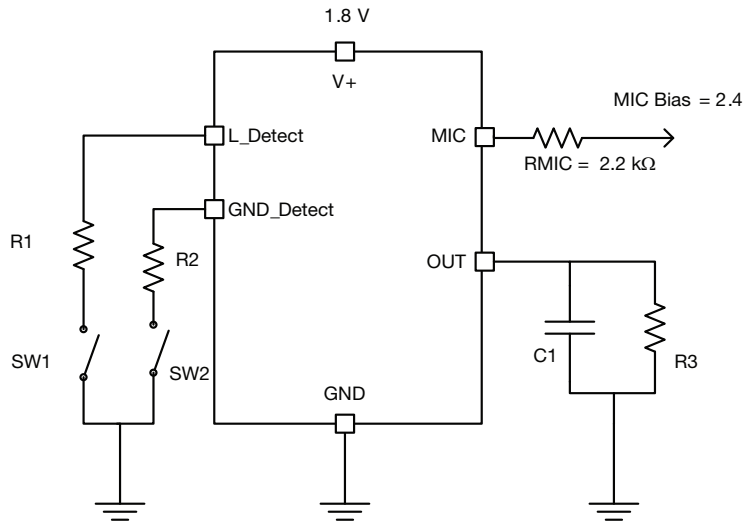
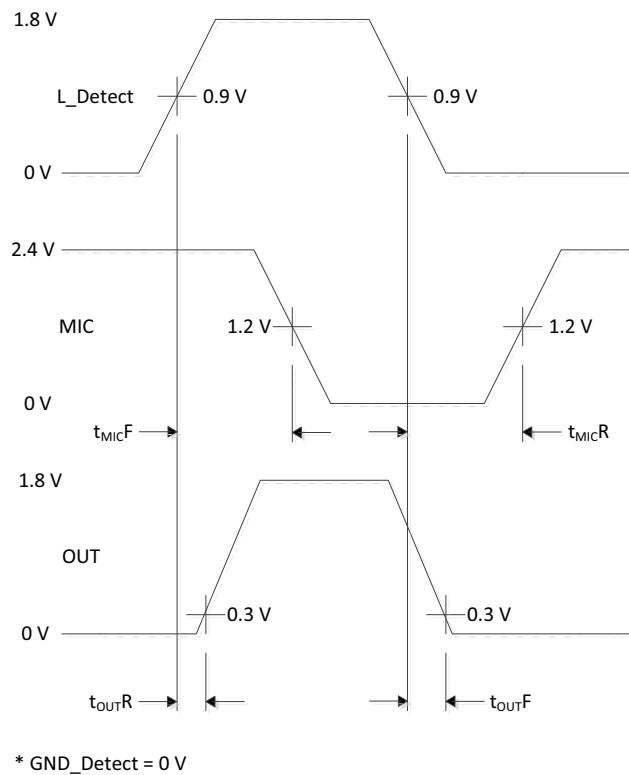
**TEST CIRCUIT**

**Fig. 4 - Test Circuit**
**TIMING DIAGRAM**

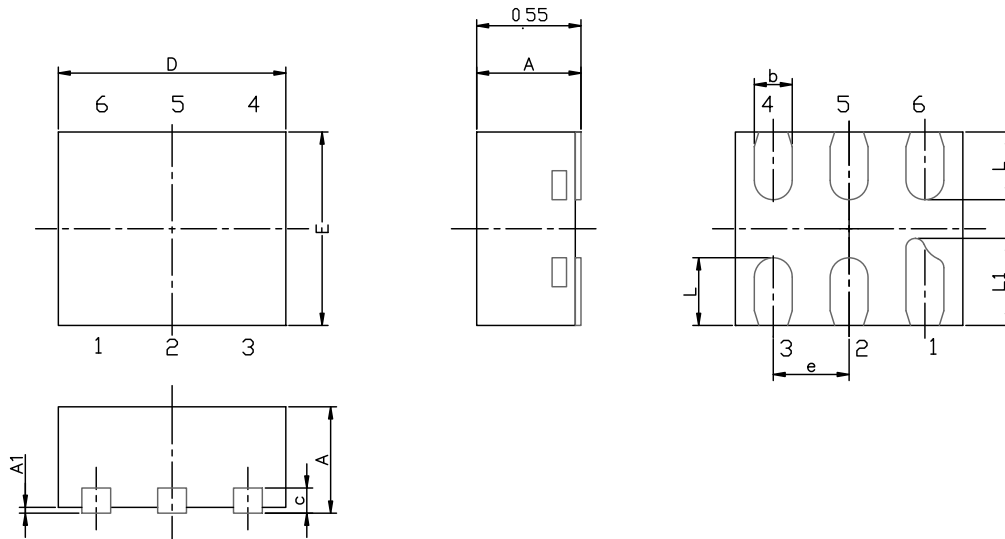
**Fig. 5 - Timing Diagram**



**MINI QFN-6L CASE OUTLINE**

DIM.	MILLIMETERS			INCHES		
	MIN.	NOM.	MAX.	MIN.	NOM.	MAX.
A	0.50	0.55	0.60	0.0197	0.0217	0.0236
A1	0	-	0.05	0	-	0.002
b	0.15	0.20	0.25	0.006	0.008	0.010
c	0.15 ref.			0.006 ref.		
D	1.15	1.20	1.25	0.045	0.047	0.049
E	0.95	1.00	1.05	0.037	0.039	0.041
e	0.40 BSC			0.016 BSC		
L	0.30	0.35	0.40	0.012	0.014	0.016
L1	0.40	0.45	0.50	0.016	0.018	0.020

Vishay Siliconix maintains worldwide manufacturing capability. Products may be manufactured at one of several qualified locations. Reliability data for Silicon Technology and Package Reliability represent a composite of all qualified locations. For related documents such as package/tape drawings, part marking, and reliability data, see [www.vishay.com/ppg?62887](http://www.vishay.com/ppg?62887).

## MINI QFN-6L CASE OUTLINE

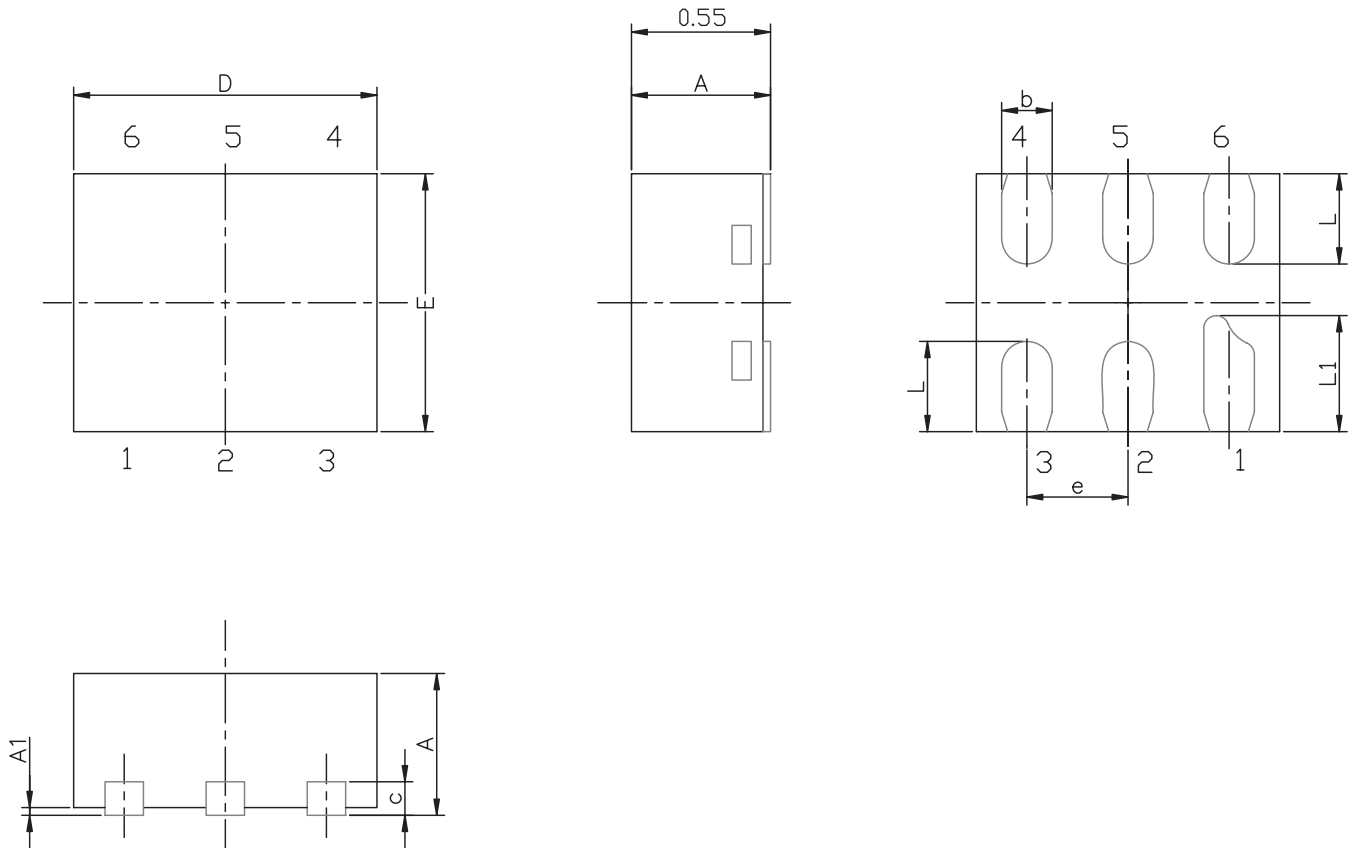

DIM	MILLIMETERS			INCHES		
	MIN.	NAM.	MAX.	MIN.	NAM.	MAX.
A	0.50	0.55	0.60	0.0197	0.0217	0.0236
A1	0.00	-	0.05	0.000	-	0.002
b	0.15	0.20	0.25	0.006	0.008	0.010
c	0.15 REF			0.006 REF		
D	1.15	1.20	1.25	0.045	0.047	0.049
E	0.95	1.00	1.05	0.037	0.039	0.041
e	0.40 BSC			0.016 BSC		
L	0.30	0.35	0.40	0.012	0.014	0.016
L1	0.40	0.45	0.50	0.016	0.018	0.020

ECN T-07039-Rev. A, 12-Feb-07  
 DWG: 5958

**RECOMMENDED MINIMUM PADS FOR MINI QFN 6L**

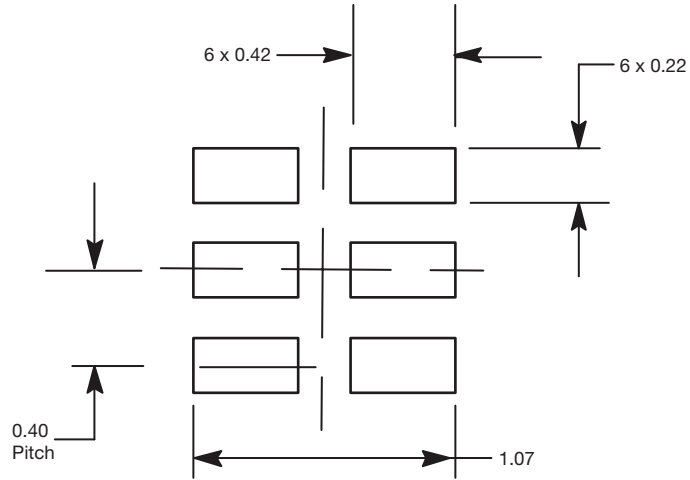

Mounting Footprint  
Dimensions in mm



## Disclaimer

ALL PRODUCT, PRODUCT SPECIFICATIONS AND DATA ARE SUBJECT TO CHANGE WITHOUT NOTICE TO IMPROVE RELIABILITY, FUNCTION OR DESIGN OR OTHERWISE.

Vishay Intertechnology, Inc., its affiliates, agents, and employees, and all persons acting on its or their behalf (collectively, "Vishay"), disclaim any and all liability for any errors, inaccuracies or incompleteness contained in any datasheet or in any other disclosure relating to any product.

Vishay makes no warranty, representation or guarantee regarding the suitability of the products for any particular purpose or the continuing production of any product. To the maximum extent permitted by applicable law, Vishay disclaims (i) any and all liability arising out of the application or use of any product, (ii) any and all liability, including without limitation special, consequential or incidental damages, and (iii) any and all implied warranties, including warranties of fitness for particular purpose, non-infringement and merchantability.

Statements regarding the suitability of products for certain types of applications are based on Vishay's knowledge of typical requirements that are often placed on Vishay products in generic applications. Such statements are not binding statements about the suitability of products for a particular application. It is the customer's responsibility to validate that a particular product with the properties described in the product specification is suitable for use in a particular application. Parameters provided in datasheets and/or specifications may vary in different applications and performance may vary over time. All operating parameters, including typical parameters, must be validated for each customer application by the customer's technical experts. Product specifications do not expand or otherwise modify Vishay's terms and conditions of purchase, including but not limited to the warranty expressed therein.

Except as expressly indicated in writing, Vishay products are not designed for use in medical, life-saving, or life-sustaining applications or for any other application in which the failure of the Vishay product could result in personal injury or death. Customers using or selling Vishay products not expressly indicated for use in such applications do so at their own risk. Please contact authorized Vishay personnel to obtain written terms and conditions regarding products designed for such applications.

No license, express or implied, by estoppel or otherwise, to any intellectual property rights is granted by this document or by any conduct of Vishay. Product names and markings noted herein may be trademarks of their respective owners.

## Material Category Policy

**Vishay Intertechnology, Inc. hereby certifies that all its products that are identified as RoHS-Compliant fulfill the definitions and restrictions defined under Directive 2011/65/EU of The European Parliament and of the Council of June 8, 2011 on the restriction of the use of certain hazardous substances in electrical and electronic equipment (EEE) - recast, unless otherwise specified as non-compliant.**

**Please note that some Vishay documentation may still make reference to RoHS Directive 2002/95/EC. We confirm that all the products identified as being compliant to Directive 2002/95/EC conform to Directive 2011/65/EU.**

**Vishay Intertechnology, Inc. hereby certifies that all its products that are identified as Halogen-Free follow Halogen-Free requirements as per JEDEC JS709A standards. Please note that some Vishay documentation may still make reference to the IEC 61249-2-21 definition. We confirm that all the products identified as being compliant to IEC 61249-2-21 conform to JEDEC JS709A standards.**