

| FCI PART NUMBER | DESCRIPTION | NOTES |
|-----------------|---------------------------------------|-------------|
| 10122527-XXXXLF | CONTROLLER TO BACKPLANE CONFIGURATION | SEE TABLE 2 |

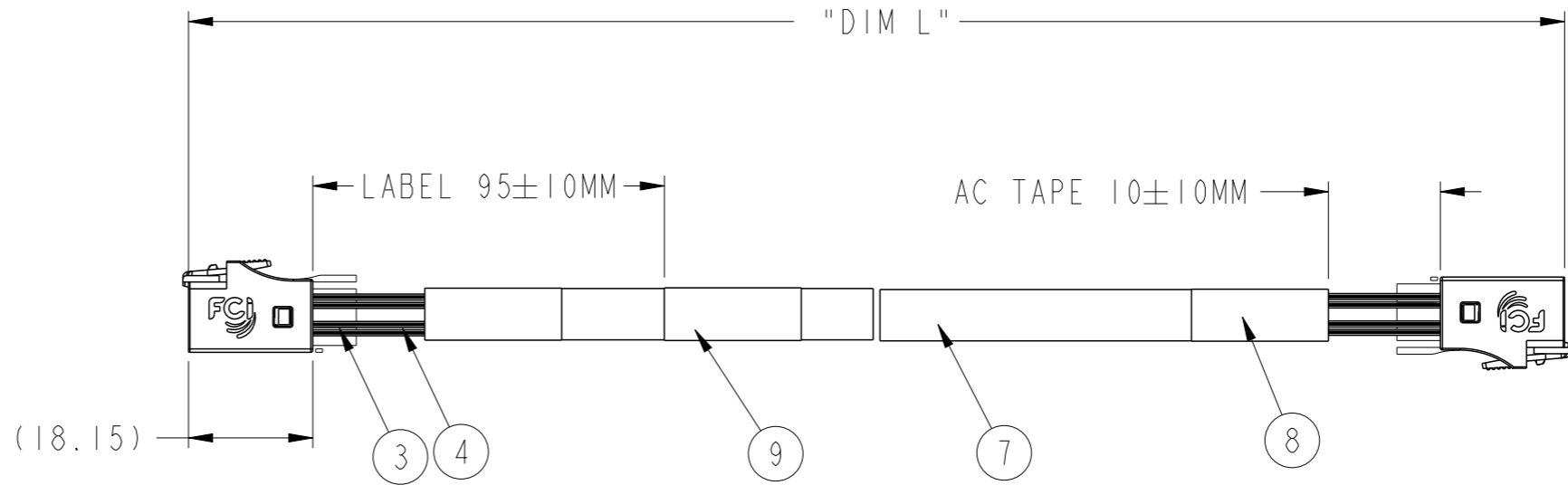
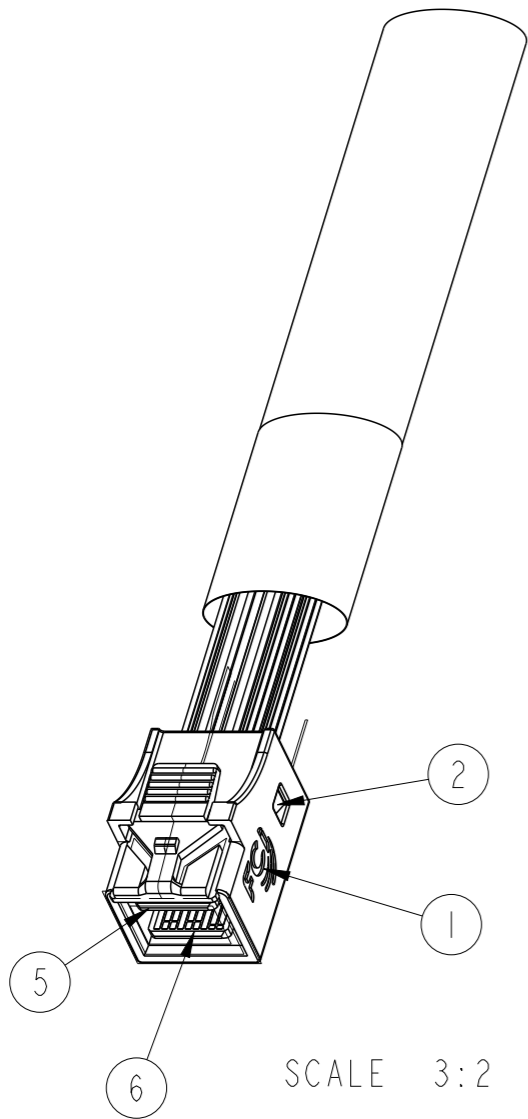

TABLE 1 - BILL OF MATERIALS

| ITEM | DESCRIPTION | QTY | NOTES |
|------|--------------------------------------|-----|------------|
| 1 | mSAS HD INTERNAL HOUSING- SHORT | 2 | |
| 2 | mSAS HD INTERNAL PCB INSERT- SHORT | 2 | |
| 3 | 3M FLAT RIBBON CABLE (30 AWG) | A/R | |
| 4 | SIDE BAND FLAT RIBBON CABLE (30 AWG) | A/R | |
| 5 | mSAS HD INTERNAL LOWER (A-B) PCB | 2 | |
| 6 | mSAS HD INTERNAL UPPER (C-D) PCB | 2 | |
| 7 | PLASTIC BRAID | A/R | |
| 8 | ACETATE TAPE 20mm BLACK | A/R | |
| 9 | LABEL | 1 | SEE NOTE 5 |
| 10 | 3525 LOCTITE | A/R | NOT SHOWN |

| | | | | | | | | | | |
|---------------|---------------------------------------|---------|---------|------------|------------|----|-------------------------------------|---------------|--------------------|----------|
| spec ref | - | dr | Andy Wu | 2013/01/03 | projection | mm | size | A3 | scale | 1:1 |
| tolerance std | ISO 406 ISO 1101 | eng | Ya LI | 2015/04/28 | | | ecn no | ELX-N-20750-1 | | |
| | TOLERANCES UNLESS OTHERWISE SPECIFIED | chr | - | apppr | | | Delhy Liu | 2015/04/28 | product family | - |
| surface | ISO 1302 | linear | 0.X | ±0.3 | | | mSAS HD INTERNAL (4i) | | dwg no 10122527 | rev J |
| | | | 0.XX | ±0.10 | | | CABLE ASSEMBLY- 12 Gb/s, short type | | | |
| | | angular | 0° | ±2° | | | cat. no. | - | | |

| FCI PART NUMBER | DESCRIPTION | NOTES |
|-----------------|---------------------------------------|-------------|
| 10122527-XXXXLF | CONTROLLER TO BACKPLANE CONFIGURATION | SEE TABLE 2 |

| TABLE 2- CABLE PART NUMBER LIST | | | |
|---------------------------------|-------------------------------|-----|--|
| PART NUMBER | "DIM L" CABLE LENGTH (METERS) | AWG | NOTES |
| 10122527-2030LF | 0.3 | 30 | CONTROLLER TO BACKPLANE WIRING CONFIGURATION (SHEET 2) ----- (SEE SHEET 4 FOR ALL NOTES) |
| 10122527-2040LF | 0.4 | 30 | |
| 10122527-2050LF | 0.5 | 30 | |
| 10122527-2060LF | 0.6 | 30 | |
| 10122527-2070LF | 0.7 | 30 | |
| 10122527-2075LF | 0.75 | 30 | |
| 10122527-2080LF | 0.8 | 30 | |
| 10122527-2090LF | 0.9 | 30 | |
| 10122527-2100LF | 1.0 | 30 | |
| 10122527-2035LF | 0.35 | 30 | |
| 10122527-2043LF | 0.436 | 30 | |
| 10122527-2095LF | 0.95 | 30 | |



- NOTE:
1. ALL CABLE PERFORMANCE COMPLIANCE SAS3.0
 2. CABLE MORE THAN 1.0 METER COULD NOT MEET SAS3.0 INSERTION LOSS -11dB MAX.

| | | | | | | | | | | | | | |
|---------------------------------------|---------------------|---------|---------|------------|------------|--|--------------------|---------------|-------------|----------|------------------------|--------------|--|
| spec ref | - | dr | Andy Wu | 2013/01/03 | projection | mm | size | A3 | scale | 1:2 | | | |
| tolerance std | ISO 406 ISO 1101 | eng | Ya Li | 2015/04/28 | | | ecn no | ELX-N-20750-1 | | | | | |
| TOLERANCES UNLESS OTHERWISE SPECIFIED | | chr | - | - | | | product family | - | rel level | Released | | | |
| surface | ISO 1302 | linear | 0.X | ±0.3 | | mSAS HD INTERNAL (4i) CABLE ASSEMBLY- 12 Gb/s, short type | dwg no 10122527 | rev J | www.fci.com | | | | |
| | | | 0.XX | ±0.10 | | | | | cat. no. | - | Product - Customer Drw | sheet 2 of 4 | |
| | | angular | 0° | ±2° | | | | | | | | | |



Copyright FCI.

| FCI PART NUMBER | DESCRIPTION | NOTES |
|-----------------|---------------------------------------|-------------|
| 10122527-XXXXLF | CONTROLLER TO BACKPLANE CONFIGURATION | SEE TABLE 2 |

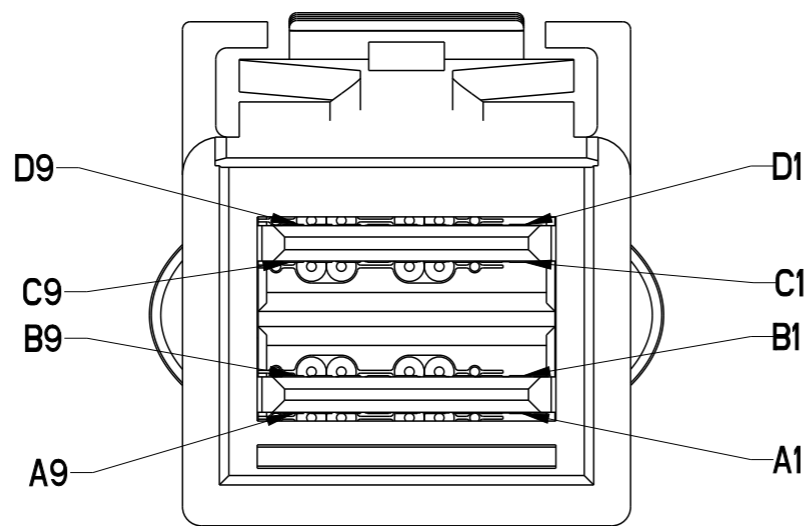

SCALE 5:1

| LEGEND | |
|--------|--------------------------------------|
| | HIGH-SPEED SERIAL DIFFERENTIAL PAIRS |
| | SIGNAL RETURN |
| | SIDEBAND SIGNAL |

| WIRING LIST (CONTROLLER TO BACKPLANE) | | | | |
|---------------------------------------|------------|-------|--------------------|------------|
| END P1 (CONTROLLER) | | | END P2 (BACKPLANE) | |
| POSITION | SYMBOL | | POSITION | SYMBOL |
| D9 | GROUND | ----- | B9 | GROUND |
| D8 | Tx2- | | B8 | Rx2- |
| D7 | Tx2+ | | B7 | Rx2+ |
| D6 | GROUND | ----- | B6 | GROUND |
| D5 | Tx0- | | B5 | Rx0- |
| D4 | Tx0+ | | B4 | Rx0+ |
| D3 | GROUND | ----- | B3 | GROUND |
| D2 | SIDEBAND 6 | | D1 | SIDEBAND 6 |
| D1 | SIDEBAND 5 | | D2 | SIDEBAND 5 |
| C1 | SIDEBAND 4 | | C2 | SIDEBAND 4 |
| C2 | SIDEBAND 2 | | C1 | SIDEBAND 2 |
| C3 | GROUND | ----- | A3 | GROUND |
| C4 | Tx1+ | | A4 | Rx1+ |
| C5 | Tx1- | | A5 | Rx1- |
| C6 | GROUND | ----- | A6 | GROUND |
| C7 | Tx3+ | | A7 | Rx3+ |
| C8 | Tx3- | | A8 | Rx3- |
| C9 | GROUND | ----- | A9 | GROUND |
| B9 | GROUND | ----- | D9 | GROUND |
| B8 | Rx2- | | D8 | Tx2- |
| B7 | Rx2+ | | D7 | Tx2+ |
| B6 | GROUND | ----- | D6 | GROUND |
| B5 | Rx0- | | D5 | Tx0- |
| B4 | Rx0+ | | D4 | Tx0+ |
| B3 | GROUND | ----- | D3 | GROUND |
| B2 | SIDEBAND 1 | | B1 | SIDEBAND 1 |
| B1 | SIDEBAND 3 | | B2 | SIDEBAND 3 |
| A1 | SIDEBAND 7 | | A2 | SIDEBAND 7 |
| A2 | SIDEBAND 0 | | A1 | SIDEBAND 0 |
| A3 | GROUND | ----- | C3 | GROUND |
| A4 | Rx1+ | | C4 | Tx1+ |
| A5 | Rx1- | | C5 | Tx1- |
| A6 | GROUND | ----- | C6 | GROUND |
| A7 | Rx3+ | | C7 | Tx3+ |
| A8 | Rx3- | | C8 | Tx3- |
| A9 | GROUND | ----- | C9 | GROUND |

| | | | | | | | | | | | |
|---------------------------------------|--|-------------|------------|------------|-----------------------|------------------------|--------------|---------------|-----------|----------|----------------|
| spec ref | - | dr | Andy Wu | 2013/01/03 | projection | mm | size | A3 | scale | 1:1 | |
| tolerance std | ISO 406 ISO 1101 | eng | Ya Li | 2015/04/28 | | ← → | ecn no | ELX-N-20750-1 | rel level | Released | |
| TOLERANCES UNLESS OTHERWISE SPECIFIED | | chr | - | 2015/04/28 | | | | | | | product family |
| surface | ISO 1302 | appr | Delhly Liu | 2015/04/28 | mSAS HD INTERNAL (4i) | | 10122527 | | rev | J | |
| linear | 0.X ±0.3 0.XX ±0.10 0.XXX ±0.005 | www.fci.com | | cat. no. | - | Product - Customer Drw | sheet 3 of 4 | | | | |
| angular | 0° ±2° | | | | | | | | | | |



Copyright FCI.

NOTES:

1. MATERIAL:
 HOUSINGS: MODIFIED POLYPHENYLENE ETHER
 PADDLE CARD: PRINTED CIRCUIT SUBSTRATE
 HEAT SHRINK TUBE: POLYOLEFIN
 EPOXY LOCTITE

2. THIS PRODUCT MEETS THE RESTRICTION OF HAZARDOUS SUBSTANCES IN ELECTRICAL AND ELECTRONIC EQUIPMENT (RoHS) DIRECTIVE (2002/95/EC)

3. THIS DIMENSION IS A FINISHED PRODUCT LENGTH.

4. UNLESS OTHERWISE SPECIFIED ASSEMBLED LENGTH TOLERANCE IS TO BE:
 "DIM L" < 1 METER = 25mm
 "DIM L" 1 METER TO 10 METERS = 2% OF "DIM L"

5. UNLESS OTHERWISE SPECIFIED LABEL POSITION IS TO BE 95mm FROM REAR OF PI CONNECTOR.
 LABEL DETAILS:
 MANUFACTURER CODE OR NAME COUNTRY OF ORIGIN
 CUSTOMER P/N OR FCI P/N
 REVISION
 DATE CODE (YYYY/MM/DD FORMAT) - SERIAL NUMBER

FONT SHALL BE CLEARLY VISIBLE AND BLACK IN COLOR.

6. ALL CABLE ASSEMBLIES SHALL BE 100% TESTED FOR CONTINUITY AS DEFINED IN WIRING LIST.

7. ALL CABLE ASSEMBLIES SHALL BE 100% HI-POT TESTED BH APPLYING 300V DC FOR A MINIMUM OF 10ms.

8. IMPEDANCE: 100 DIFFERENTIAL.

9. OTHER TESTING PERFORMED AS REQUIRED BY PRODUCT SPECIFICATION: GS-12-650.

10. PACKAGE AND LABEL CABLE ASSEMBLIES PER GS-14-1272.





11. A "  " SYMBOL WILL BE NEXT TO ANY DIMENSION, VIEW, OR NOTE WHICH HAS BEEN MODIFIED WITH THE CURRENT DRAWING REVISION. THE CURRENT REVISION WILL BE SHOWN IN THE SYMBOL.

12. "HLF" PRODUCT NUMBERS DESIGNATE THE USE OF HALOGEN FREE RAW CABLE.

13. HALOGEN FREE RAW CABLE CAN BE USED AS A SUBSTITUTE ON NON-HF PRODUCT NUMBERS.

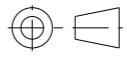
14. PART NUMBER/SUPPLIER SUBSTITUTION IS NOT ALLOWED.

15. THIS PRODUCT CONFORMS TO THE MECHANICAL DIMENSIONING AND ELECTRICAL REQUIREMENTS OF THE SFF-8643 SPECIFICATION.

| | | | | | | | | | | | | | | |
|---------------------|---|---------------------------------------|-------|--------|---|------------|---|---|----------------|-----------------------------|--------|----------|-----|----------|
| spec ref | | - | | dr | Andy Wu | 2013/01/03 | projection  | mm  | size | A3 | scale | 1:1 | | |
| tolerance std | | TOLERANCES UNLESS OTHERWISE SPECIFIED | | eng | Ya Li | 2015/04/28 | | | ecn no | ELX-N-20750-1 | | | | |
| ISO 406 ISO 1101 | | | | chr | - | - | | | product family | - rel level Released | | | | |
| surface |  | linear | 0.X | ±0.3 |  | cat. no. | - | Product - Customer Drw | sheet 4 of 4 | mSAS HD INTERNAL (4i) | dwg no | 10122527 | rev | J |
| | | | 0.XX | ±0.10 | | | | | | | | | | |
| | | | 0.XXX | ±0.005 | | | | | | | | | | |
| ISO 1302 | | angular | 0° | ±2° | www.fci.com | | | | | | | | | |



Copyright FCI.