

HIGH SNR SUPPORT BOTTOM PORT SISONIC™ MICROPHONE

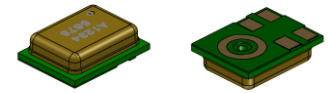

The SPH6611LR5H-1 is a miniature, high-performance, low power, matched sensitivity bottom port silicon microphone. Using Knowles' proven high-performance SiSonic™ MEMS technology, the SPH6611LR5H-1 consists of an acoustic sensor, a low noise input buffer, and an output amplifier. These devices are suitable for applications such as cellphones, smart phones, laptop computers, sensors, digital still cameras, portable music recorders, and other portable electronic devices where excellent wideband audio performance and RF immunity are required.

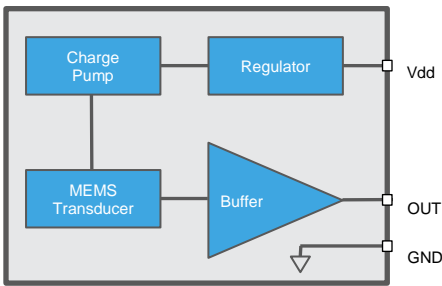

PRODUCT FEATURES

- Matched Sensitivity
- LGA Package
- Flat Frequency Response
- Low Current
- RF Shielded
- Bottom Port
- Ultra-Stable Performance
- Omnidirectional
- Standard SMD Reflow High SNR
- Low Distortion/ High AOP
- High Drive Capability
- Supports Dual Multiplexed Channels

ABSOLUTE MAXIMUM RATINGS

Table 1: Absolute Maximum Ratings

Parameter	Absolute Maximum Rating	Units
Vdd to Ground	-0.3, +5.0	V
OUT to Ground	-0.3, Vdd+0.5	V
Input Current	±5	mA
Storage Temperature	Indefinite to Ground or Vdd	°C
Operating Temperature	-40 to +100	°C

Stresses exceeding these "Absolute Maximum Ratings" may cause permanent damage to the device. These are stress ratings only. Functional operation at these or any other conditions beyond those indicated under "Acoustic & Electrical Specifications" is not implied. Exposure beyond those indicated under "Acoustic & Electrical Specifications" for extended periods may affect device reliability.

TYPICAL APPLICATIONS

- Headsets
- Portable electronics
- Cellphones
- Laptop Computers
- Tablets
- Portable Music Recorders



ACOUSTIC & ELECTRICAL SPECIFICATIONS¹

Table 2: General Microphone Specifications

Test Conditions: 23 ±2°C, 55±20% R.H., Vdd=1.8V, no load, unless otherwise indicated

Parameter	Symbol	Conditions	Min	Typ	Max	Units
Supply Voltage	Vdd		1.5	-	3.6	V
Supply Current	Idd	Vdd = 1.8 V	-	145	185	µA
Sensitivity	S	94 dB SPL @ 1kHz	-39	-38	-37	dBV/Pa
Signal to Noise Ratio	SNR	94 dB SPL @ 1kHz, A-weighted	-	65	-	dBV/Pa
Near-Ultrasonic SNR		94 dB SPL, @ 19 kHz, BW = 18.5 - 20.0 kHz	-	79	-	dB
Total Harmonic Distortion	THD	94 dB SPL @ 1 kHz	-	0.2	0.5	%
		115 dB SPL @ 1 kHz	-	2.0	-	
		1% THD @ 1 kHz, S = typ	-	108	-	dB SPL
Acoustic Overload Point	AOP	10% THD @ 1 kHz, S = typ	-	124	-	dB SPL
Low Frequency Rolloff	LFRO	-3dB relative to 1 kHz	-	90	-	Hz
High Frequency Flatness		+3dB relative to 1 kHz	-	12	-	kHz
Resonant Frequency Peak	Fres		-	25	-	kHz
Power Supply Rejection Ratio	PSRR	200 mVpp sine wave @ 1 kHz, Single-Ended Mode	-	68	-	dB
Power Supply Rejection	PSR+N	100 mVpp square wave @ 217 Hz, Vdd = 1.8V, A-weighted, Single-Ended	-	-92	-	dBV(A)
DC Output		Vdd = 1.8 V	-	1.1	-	V
Output Impedance	Zout	@ 1 kHz	-	-	400	Ω
Output Load	Cload		-	-	50	pF
	Rload	AC-coupled	10	-	-	kΩ
Sensitivity Drop		Vdd(min) ≤ Vdd ≤ Vdd(max)	-	-	±0.25	dB
Directivity			Omnidirectional			
Polarity		Increasing sound pressure	Increasing Output Voltage			
Startup Time		S within 1 dB of final value, outputs AC coupled	-	-	50	ms

¹ Sensitivity and Supply Current are 100% tested.

Figure 1: Typical Application Circuit

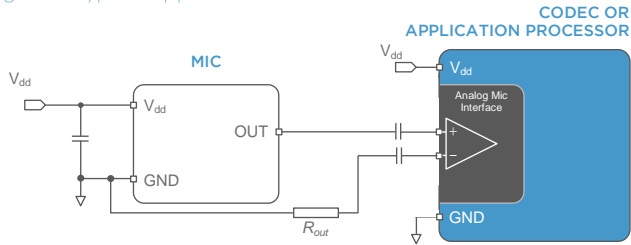

NOTES:

Bypass capacitors should be placed next to each Vdd pin for best performance.
Capacitors near the microphone should not contain Class 2 dielectrics due to their piezoelectric effect.
Follow the codec manufacturer's recommendations for circuitry and layout.

PERFORMANCE CURVES

Test Conditions: 23 ±2°C, 55±20% R.H., Vdd=1.8V, no load, unless otherwise indicated

Figure 2: Typical Free Field Magnitude and Phase Response

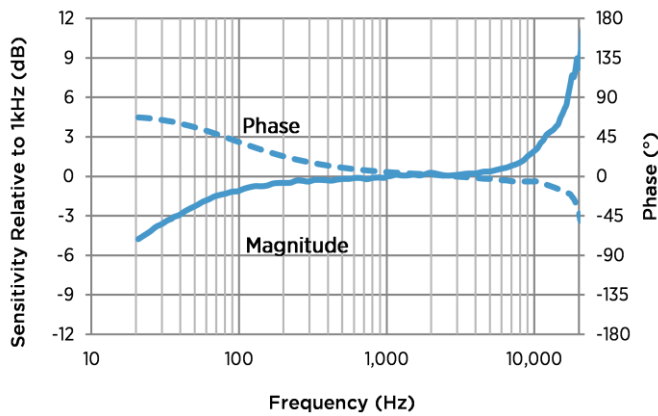

Figure 4: Typical THD vs SPL

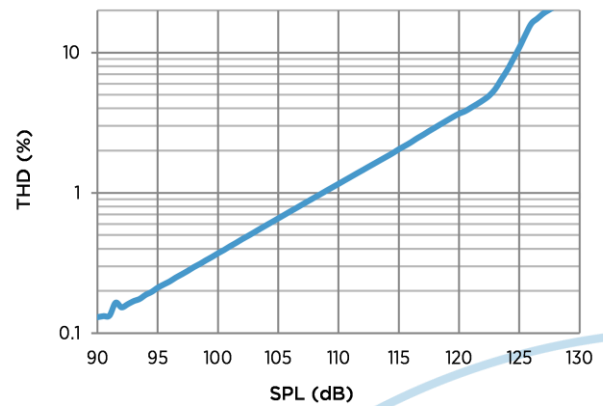

Figure 3: Typical Group Delay

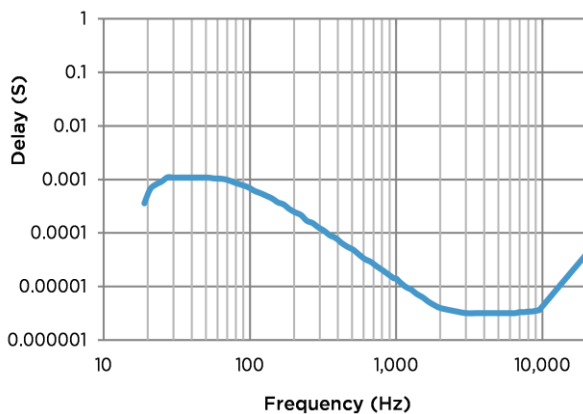

Figure 5: Typical THD vs Frequency

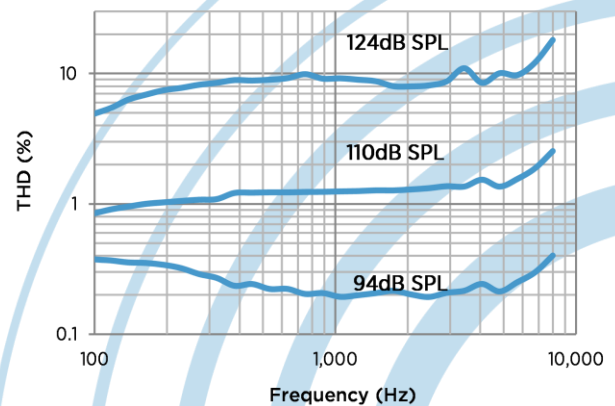

Figure 6: Typical Free Field Ultrasonic Response

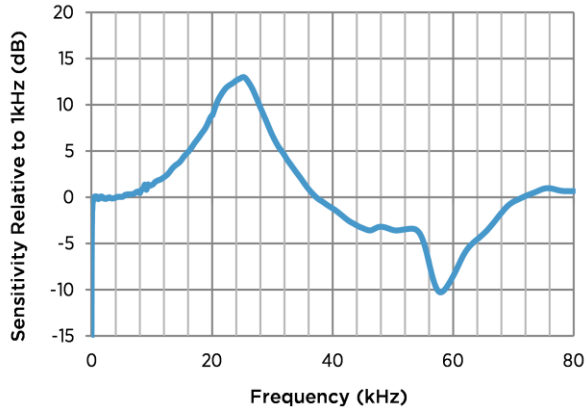

Figure 8: Noise Floor Power Spectral Density

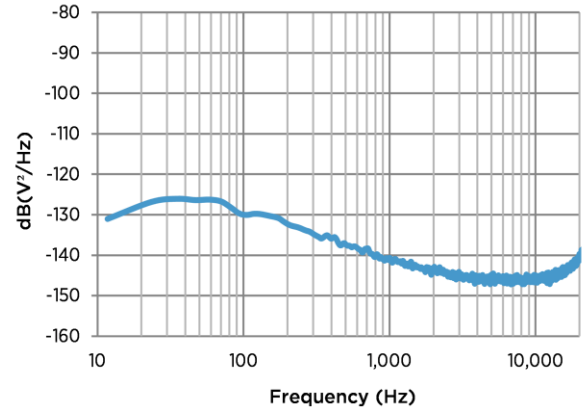

Figure 7: Typical I_{dd} vs V_{dd}

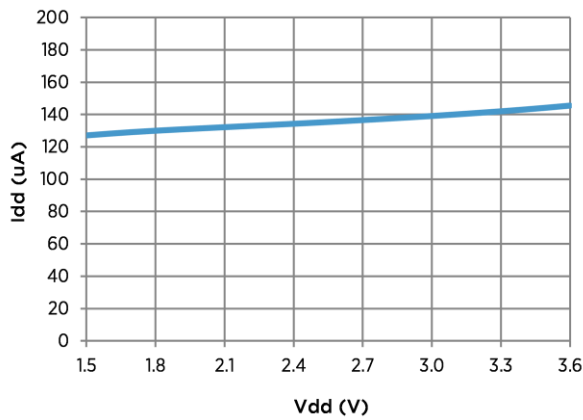
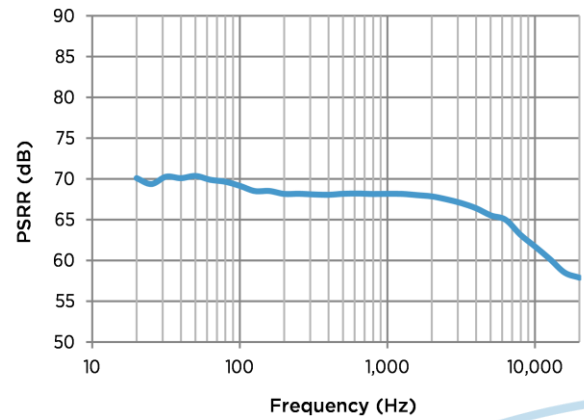
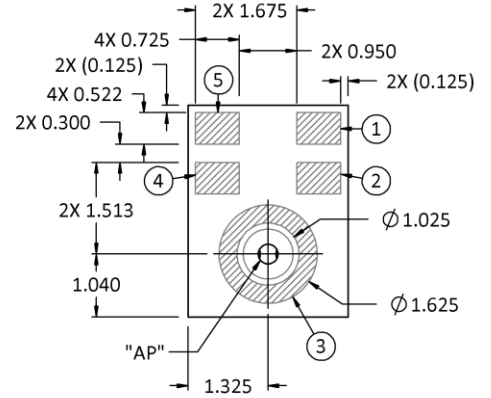
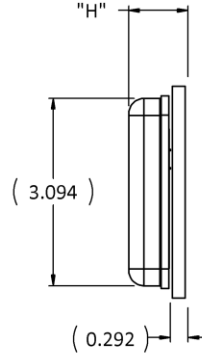
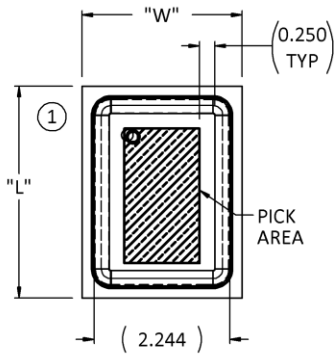

Figure 9: Typical PSRR



MECHANICAL SPECIFICATIONS



Item	Dimension	Tolerance
Length (L)	3.50	±0.10
Width (W)	2.65	±0.10
Height (H)	0.98	±0.10
Acoustic Port (AP)	∅0.325	±0.05
PCB Thickness (T)	0.292	-0.05, +0.05

Pin #	Pin Name	Type	Description
1	OUT	Signal	Output Signal
2, 3	GROUND	Power	Ground
4	Test Pin (Knowles Internal use)	N/A	Connect to Ground
5	Vdd	Power	Power Supply

Example Land Pattern

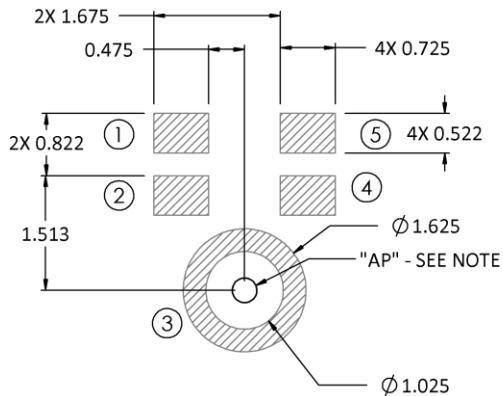

Example Solder Stencil Pattern

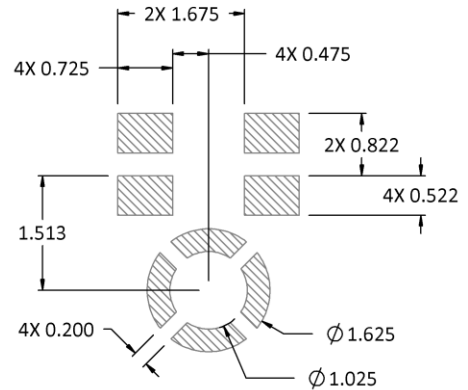

NOTES:

Pick Area only extends to 0.25 mm of any edge or hole unless otherwise specified.
Dimensions are in millimeters unless otherwise specified.

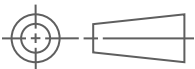

Tolerance is $\pm 0.15\text{mm}$ unless otherwise specified.

In the acoustic path, TBD the recommended PCB Hole Diameter is $0.6 \leq D \leq 1.0\text{mm}$, TBD the recommended Gasket Cavity Diameter is $D \geq 1.0\text{mm}$ and TBD the recommended Case Hole Diameter is $1.0 \leq D \leq 1.5\text{mm}$. Further optimizations based on application should be performed.

PACKAGING & MARKING DETAIL

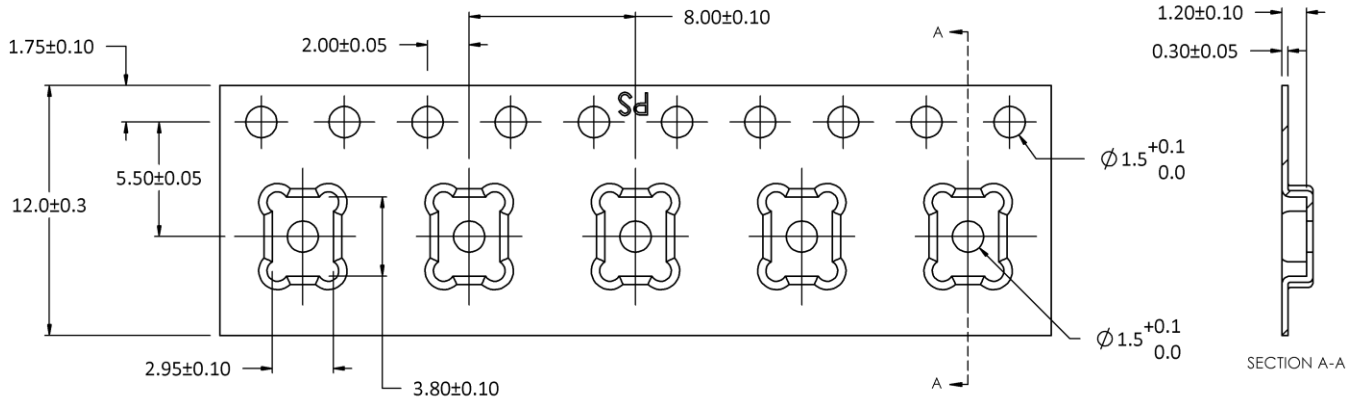

Model Number	Suffix	Reel Diameter	Quantity Per Reel
SPH6611LR5H-1	-8	13"	5900

Component	Surface Resistance (ohms)
Reel	$10^5 - 10^9$
Carrier Tape	$10^5 - 10^9$
Cover Tape	$10^4 - 10^{10}$

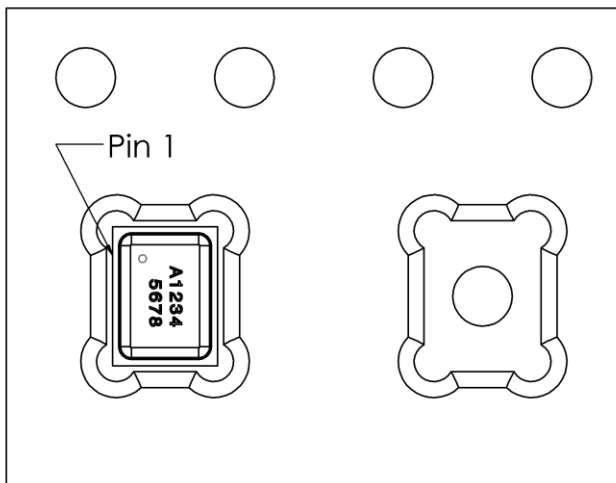

Alpha Character A:
 "S": Knowles SiSonic™ Production
 "E": Knowles Engineering Samples
 "P": Knowles Prototype Samples
 "12345678":
 Unique Job Identification Number for product traceability

NOTES:

- Dimensions are in millimeters unless otherwise specified.
- Vacuum pickup only in the pick area indicated in Mechanical Specifications.
- Tape & reel per EIA-481.
- Labels applied directly to reel and external package.
- Shelf life: Twelve (12) months when devices are stored in the factory-supplied, unopened ESD moisture sensitive bag under the maximum environmental conditions of 30°C, 70% R.H.



RECOMMENDED REFLOW PROFILE

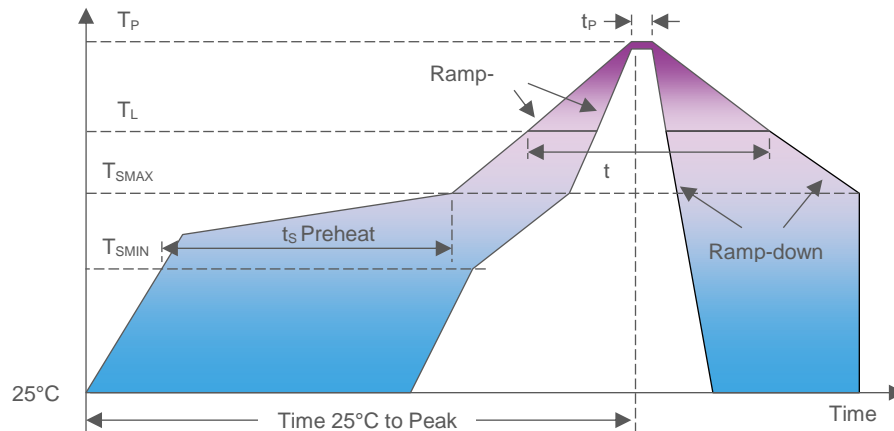

Profile Feature	Pb-Free
Average Ramp-up rate (T_{SMAX} to T_P)	3°C/second max.
Preheat <ul style="list-style-type: none"> • Temperature Min (T_{SMIN}) • Temperature Max (T_{SMAX}) • Time (T_{SMIN} to T_{SMAX}) (t_s) 	150°C 200°C 60-180 seconds
Time maintained above: <ul style="list-style-type: none"> • Temperature (T_L) • Time (t_L) 	217°C 60-150 seconds
Peak Temperature (T_P)	260°C
Time within 5°C of actual Peak Temperature (t_p)	20-40 seconds
Ramp-down rate (T_P to T_{SMAX})	6°C/second max
Time 25°C to Peak Temperature	8 minutes max

NOTES:

Based on IPC/JEDEC J-STD-020 Revision C.

All temperatures refer to topside of the package, measured on the package body surface.

The actual reflow profile used should be optimized based on the reflow requirements of all components, board design, solder paste formulation and reflow equipment used. Details of recommended handling and manufacturing processes can be found in AN25 SMT Manufacturing Guidelines for SiSonic™ Microphones.

ADDITIONAL NOTES

- (A) MSL (moisture sensitivity level) Class 1.
- (B) Maximum of 3 reflow cycles is recommended.
- (C) In order to minimize device damage:
 - Do not board wash or clean after the reflow process.
 - Do not brush board with or without solvents after the reflow process.
 - Do not directly expose to ultrasonic processing, welding, or cleaning.
 - Do not insert any object in port hole of device at any time.
 - Do not apply over 30 psi of air pressure into the port hole.
 - Do not pull a vacuum over port hole of the microphone.
 - Do not apply a vacuum when repacking into sealed bags at a rate faster than 0.5 atm/sec.



MATERIALS STATEMENT

Meets the requirements of the European RoHS directive 2011/65/EC as amended.

Meets the requirements of the industry standard IEC 61249-2-21:2003 for halogenated substances and Knowles Green Materials Standards Policy section on Halogen-Free.

Product is Beryllium Free according to limits specified on the Knowles Hazardous Material List (HSL for Products).

Ozone depleting substances are not used in the product or the processes used to make the product, including compounds listed in Annex A, B, and C of the "Montreal Protocol on Substances That Deplete the Ozone Layer."

RELIABILITY SPECIFICATIONS

Test	Description
Thermal Shock	100 cycles of air-air thermal shock from -40°C to +125°C with 15 minute soaks (IEC 68-2-4)
High Temperature Storage	+105°C environment for 1,000 hours (IEC 68-2-2 Test Ba)
Low Temperature Storage	-40°C environment for 1,000 hours (IEC 68-2-1 Test Aa)
High Temperature Bias	+105°C environment while under bias for 1,000 hours (IEC 68-2-2 Test Ba)
Low Temperature Bias	-40°C environment while under bias for 1,000 hours (IEC 68-2-1 Test Aa)
Temperature/Humidity Bias	+85°C/85% R.H. environment while under bias for 1,000 hours (JESD22-A101A-B)
Vibration	12 minutes in each X, Y, Z axis from 20 to 2,000 Hz with peak acceleration of 20 G (MIL 883E, Method 2007.2,A)
ESD-HBM	3 discharges at ±2kV direct contact to I/O pins (MIL 883E, Method 3015.7)
ESD-LID/GND	3 discharges at ±8kV direct contact to lid when unit is grounded (IEC 61000-4-2)
ESD-MM	3 discharges at ±200V direct contact to IO pins (ESD STM5.2)
Reflow	5 reflow cycles with peak temperature of +260°C
Mechanical Shock	3 pulses of 10,000 G in each of the X, Y, and Z directions (IEC 68-2-27 Test Ea)

NOTES:

Microphones meet all acoustic and electrical specifications before and after reliability testing, except sensitivity which can deviate up to 3dB.

After 3 reflow cycles, the sensitivity of the microphones shall not deviate more than 1 dB from its initial value.

SPECIFICATION REVISIONS

Revision	Specification Changes	Date
A	Initial Release #ECR-17-1865	8/9/17
B	Update datasheet format	7/16/18

Information contained herein is subject to change without notice. It may be used by a party at their own discretion and risk. We do not guarantee any results or assume any liability in connection with its use. This publication is not to be taken as a license to operate under any existing patents.