

User manual for MERUS™ MA120xxx reference boards

P100002130 REF_AUDIO_MA12040

P100002140 REF_AUDIO_MA12040P

P100002170 REF_AUDIO_MA12070

P100002180 REF_AUDIO_MA12070P

About this document

Scope and purpose

This is a reference and demonstration board for [MA12040](#), [MA12040P](#), [MA12070](#) and [MA12070P](#) proprietary multi-level amplifiers.

This application note describes the functionality and set-up of the reference design (Sections 2 and 3). It also includes a schematic, PCB layout, BOM and a discussion of circuit design considerations (Section 4). Measurement results (Section 5) show high performance in audio and efficiency parameters, as well as good thermal characteristics. Testing included a frequency sweep, output power sweep and electromagnetic interference tests. Finally, Appendix A provides sample code that demonstrates basic I²C communication using Arduino UNO.

Intended audience

Audio amplifier design engineers, audio system engineers and audio software engineers.

Table of contents

About this document.....	1
Table of contents.....	2
1 Board overview.....	3
1.1 General board specifications.....	4
1.2 RFB device type.....	4
1.3 Set-up guide.....	4
1.4 Board configuration.....	6
1.5 Device configuration through I ² C.....	7
2 Schematic, layout and design considerations.....	8
2.1 BOM.....	11
2.2 Design considerations.....	12
3 Measurement results.....	13
3.1 Frequency sweep.....	13
3.2 Output power sweep.....	15
3.3 Output spectrum.....	16
3.4 Power consumption and efficiency.....	17
3.5 EMI radiated measurements.....	20
3.5.1 EMI measurement setup.....	20
3.5.2 EMI measurement results.....	20
4 Appendix A – sample code.....	25
Revision history.....	27

Board overview

1 Board overview

The reference board (RFB) is a reference and demonstration board for Infineon’s MA12040, MA12040P, MA12070 and MA12070P amplifiers. See the board in Figure 1 with MA12070 mounted.

It contains a variety of digital/analog input, output and set-up/selection features. It also contains one on-board power supply (5 V buck converter), so only one external power supply (PVDD) is necessary.

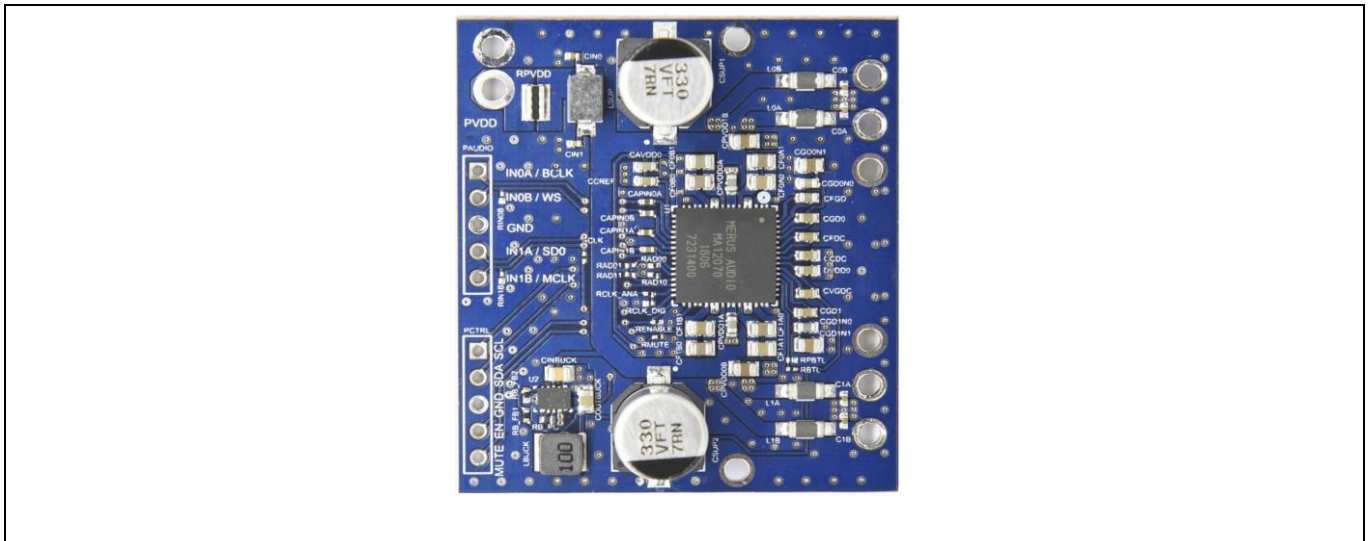

Figure 1 Reference board PCB

The board can be used for evaluating or demonstrating key features/advantages of the MERUS™ Audio technology:

- Energy efficiency
 - Power losses under normal user operating conditions (listening levels)
 - Idle power loss
- Adaptive power management system
- No output filter components
 - Solution cost and size reduction
- Audio performance
 - THD performance and audio quality
- Fast product prototyping
 - All design files are available
 - Guides as reference for product design-in

Board overview

1.1 General board specifications

- Number of audio channels 2 x BTL or 1 x PBTL
- Audio input format:
 - MA12040 and MA12070 Analog
 - MA12040P and MA12070P Digital (I²S)
- Supply voltage range MA12040(P) 5 to 18 V
- Supply voltage range MA12070(P) 5 to 26 V
- Maximum output current per channel MA12040(P) 6 A
- Maximum output current per channel MA12070(P) 8 A
- Output power capability at 18 V PVDD:
 - Peak 2 x 40 W sine 1 kHz (RMS) into 4 Ω (10 percent THD + N)
 - Peak 2 x 20 W sine 1 kHz (RMS) into 8 Ω (10 percent THD + N)
 - Continuous 2 x 9.0 W sine 1 kHz (RMS) into 4 Ω (less than 0.08 percent THD + N)
- Output power capability at 26 V PVDD:
 - Peak 2 x 80 W sine 1 kHz (RMS) into 4 Ω (10 percent THD + N)
 - Peak 2 x 40 W sine 1 kHz (RMS) into 8 Ω (10 percent THD + N)
 - Continuous 2 x 9.0 W sine 1 kHz (RMS) into 4 Ω (less than 0.02 percent THD + N)
- Amplifier gain (MA12040 and MA12070 only) 20 dB or 26 dB (register configurable)
- Output integrated noise:
 - MA12040 and MA12070 Less than 100 μV_{rms} (AW)
 - MA12040P and MA12070P Less than 150 μV_{rms} (AW)
- Dynamic range:
 - MA12040 and MA12070 More than 100 dB
 - MA12040P and MA12070P More than 96 dB
- Idle current consumption at 18 V PVDD:
 - MA12040 and MA12070 Less than 16 mA
 - MA12040P and MA12070P Less than 19 mA

Note: Idle consumption is the sum of output stage current and 5 V supply current. As all the supplies are tied to PVDD, the efficiency of the buck converter 5 V should be taken into account when measuring idle current consumption directly from PVDD. Please refer to the MA120xx/P device datasheet for exact current figures.

1.2 RFB device type

The type of device (MA12040, MA12040P, MA12070 and MA12070P) on the RFB is printed on the top of the device, and is also stated on the serial number label placed on the bottom side of the PCB.

1.3 Set-up guide

The RFB works out of the box with speakers, input source and power connected. No external configuration or set-up is needed for quick start-up.

Board overview

Figure 2 shows the top view of the board assembly. The board has following key features, which are indicated by corresponding numbers marked with red.

1. PVDD power connector: connect PVDD 5 V to 18 V for MA12040(P) or connect PVDD 5 V to 26 V for MA12070(P)
2. BTL output connection channel 0
3. BTL output connection channel 1
4. PAUDIO: signal input connector:
 - For MA12070 devices:
 - Pin 5: AN0A – analog input A channel 0
 - Pin 4: AN0B – analog input B channel 0
 - Pin 3: GND
 - Pin 2: AN1A – analog input A channel 1
 - Pin 1: AN1B – analog input B channel 1
 - For MA12070P devices:
 - Pin 5: SCK – I²S bit clock
 - Pin 4: WS – I²S word clock
 - Pin 3: GND
 - Pin 2: SD0 – I²S audio data
 - Pin 1: CLK – I²S master clock
5. PCTRL external communication:
 - Pin 5: SCL – I²C clock
 - Pin 4: SDA – I²C data
 - Pin 3: GND
 - Pin 2: /ENABLE – enable or disable the amplifier
 - Pin 1: /MUTE – mute or unmute the amplifier
6. MA12040, MA12040P, MA12070 or MA12070P Eximo multi-level amplifier IC
7. Buck regulator: TPS62175 – for generating 5 V supply

Board overview

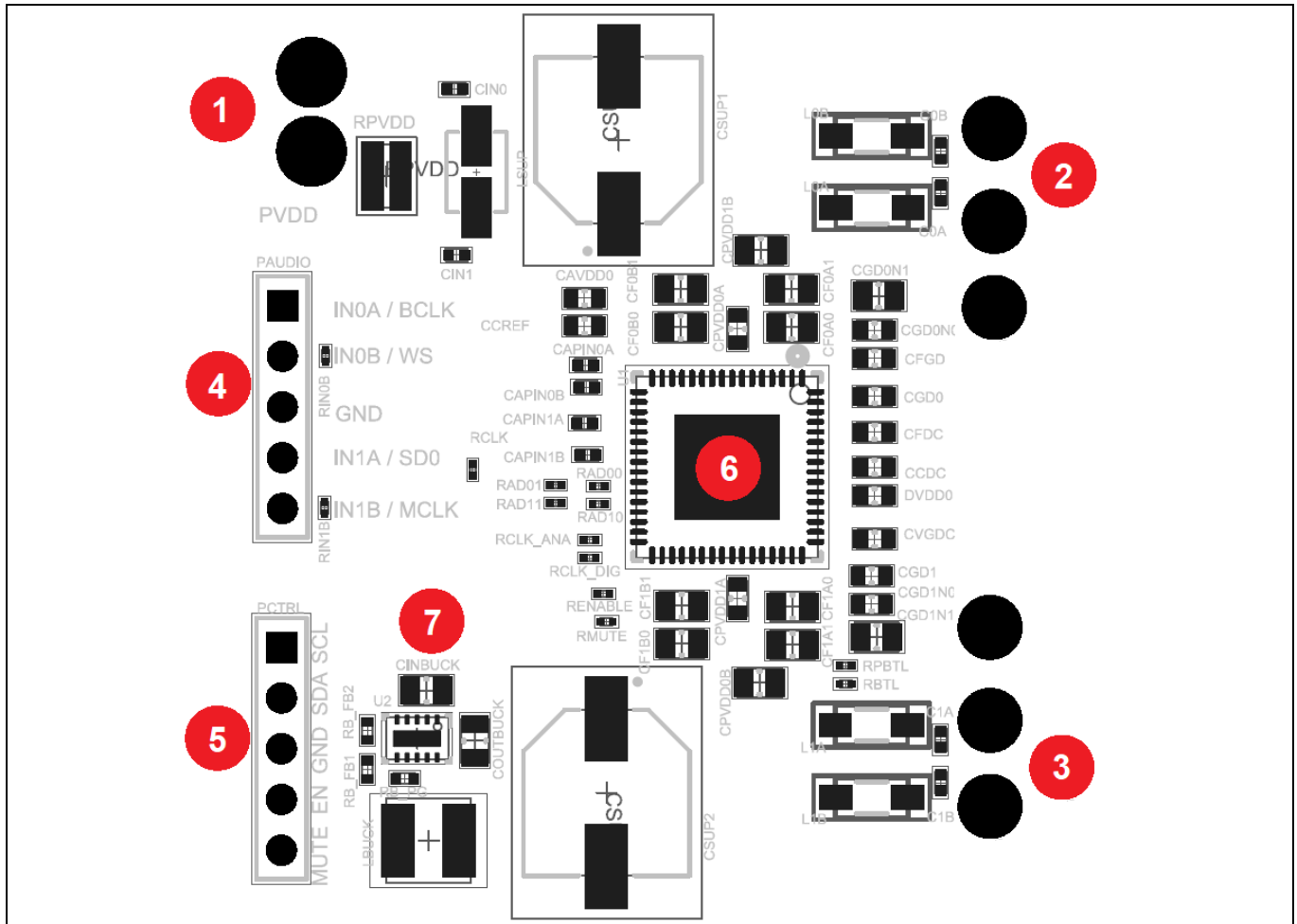

Figure 2 Schematic top view of component and connector assembly

1.4 Board configuration

The board is shipped with a default configuration for automatic start-up, two channels of BTL output, and default internal register settings. It is however possible to operate the board in different modes. The following configurations are possible:

- BTL or PBTL output configuration:
 - BTL: RPBTL **unmounted**; RBTL **mounted**
 - PBTL: RPBTL **mounted**; RBTL **unmounted**
- External control of the /ENABLE pin: RENABLE **unmounted**
- External control of the /MUTE pin: RMUTE **unmounted**

The board can carry MA12040(P) or MA12070(P) devices. Depending on which device is placed, the following configurations apply for:

- MA12040 and MA12070:
 - CAPIN0A, CAPIN0B, CAPIN1A and CAPIN1B are **mounted**
 - RCLK_ANA **mounted**; RCLK_DIG **unmounted**
 - RCLK **unmounted**
- MA12040P and MA12070P:
 - CAPIN0A, CAPIN0B, CAPIN1A and CAPIN1B **replaced by jumpers**
 - RCLK_ANA **unmounted**; RCLK_DIG **mounted**
 - RCLK **mounted**

Board overview

1.5 Device configuration through I²C

Multi-level technology offers the possibility to optimize for audio performance, efficiency or EMI. Depending on the application, typically one parameter is more important than the others. The amplifiers offer the flexibility to make this design trade-off by the use of different optimal modes (Power Mode Profiles or PMP), selected through internal register settings. The RFB uses the MA120XXX in the default PMP0, which optimizes the amplifier operation for highest power efficiency in the low to mid output power region. For a complete overview of device configurations, please refer to the datasheets.

I²C is used to read and write the internal registers. SCL and SDA can be accessed through Pin 5 and Pin 4 on the PCTRL header (see previous section). Figure 3 shows how to set up I²C communication using an Arduino UNO. Sample code for I²C set-up can be found in Appendix A – sample code.

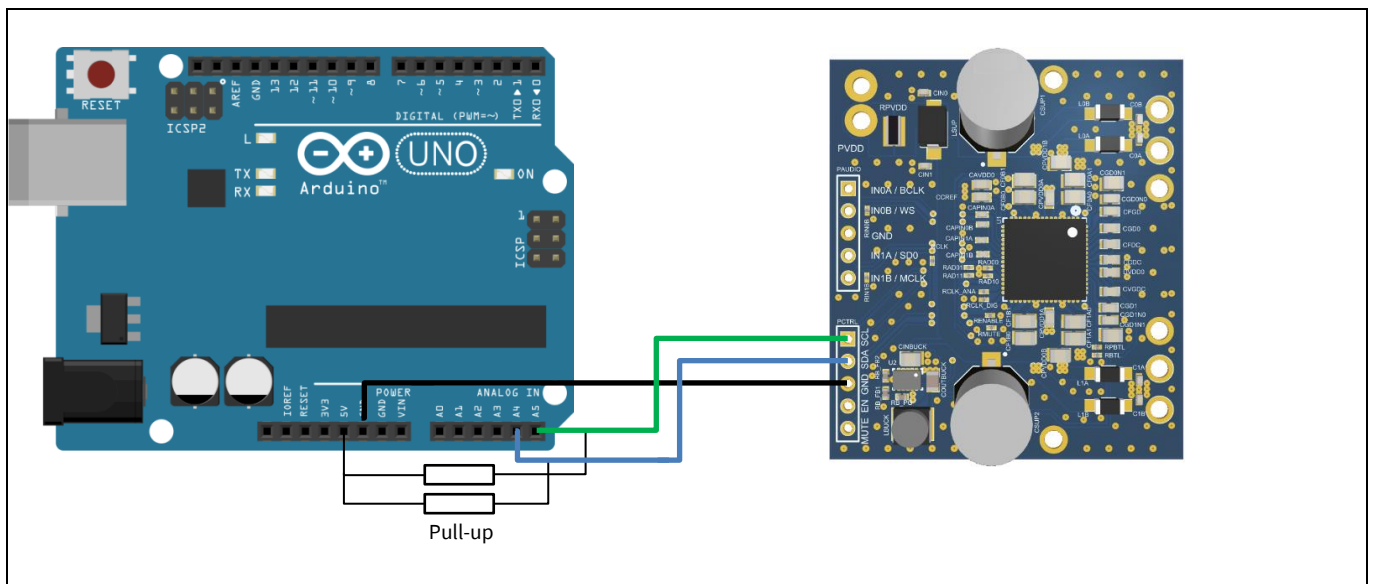

Figure 3 Arduino I²C communication to the RFB

2 Schematic, layout and design considerations

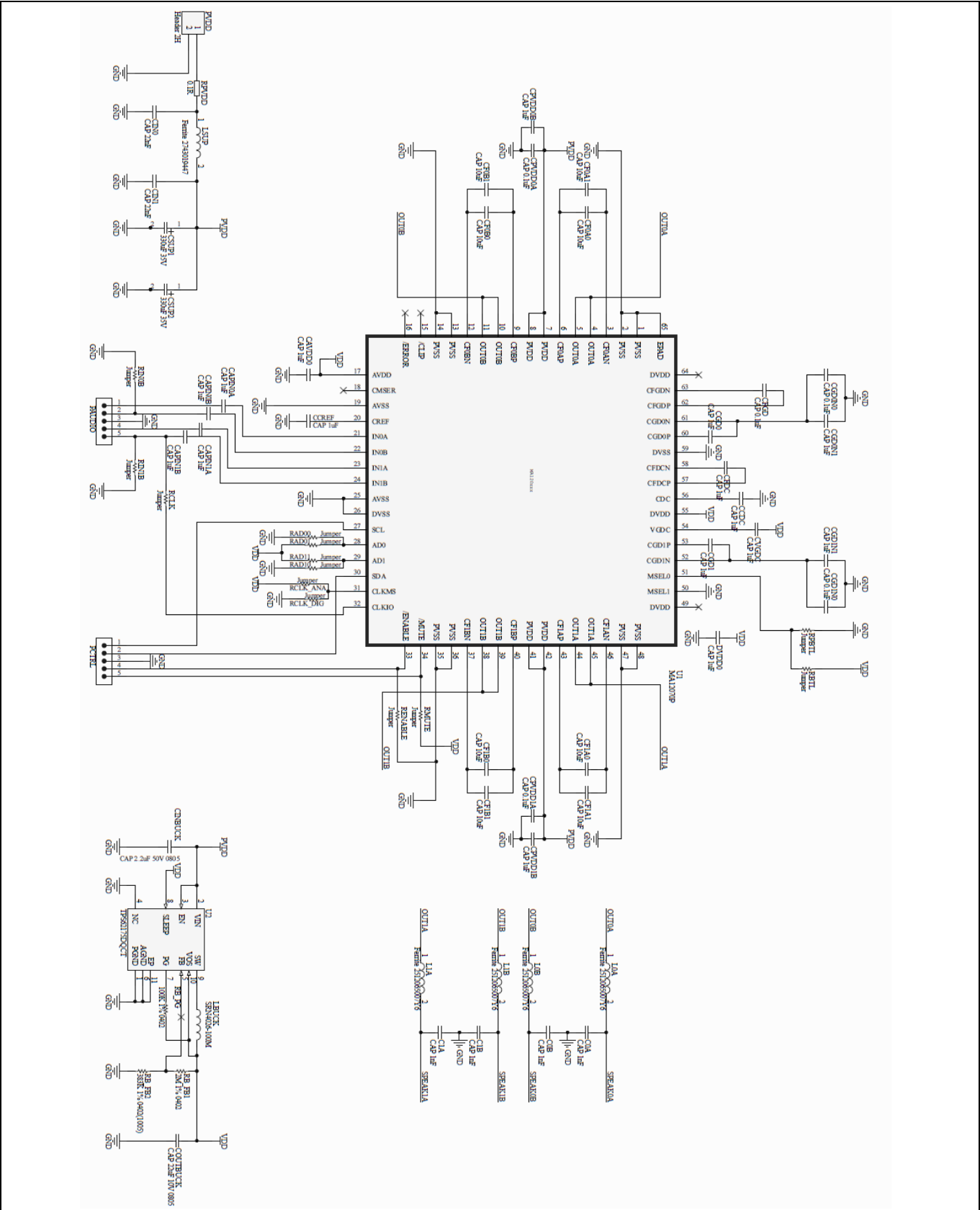

Figure 4 Reference board schematic

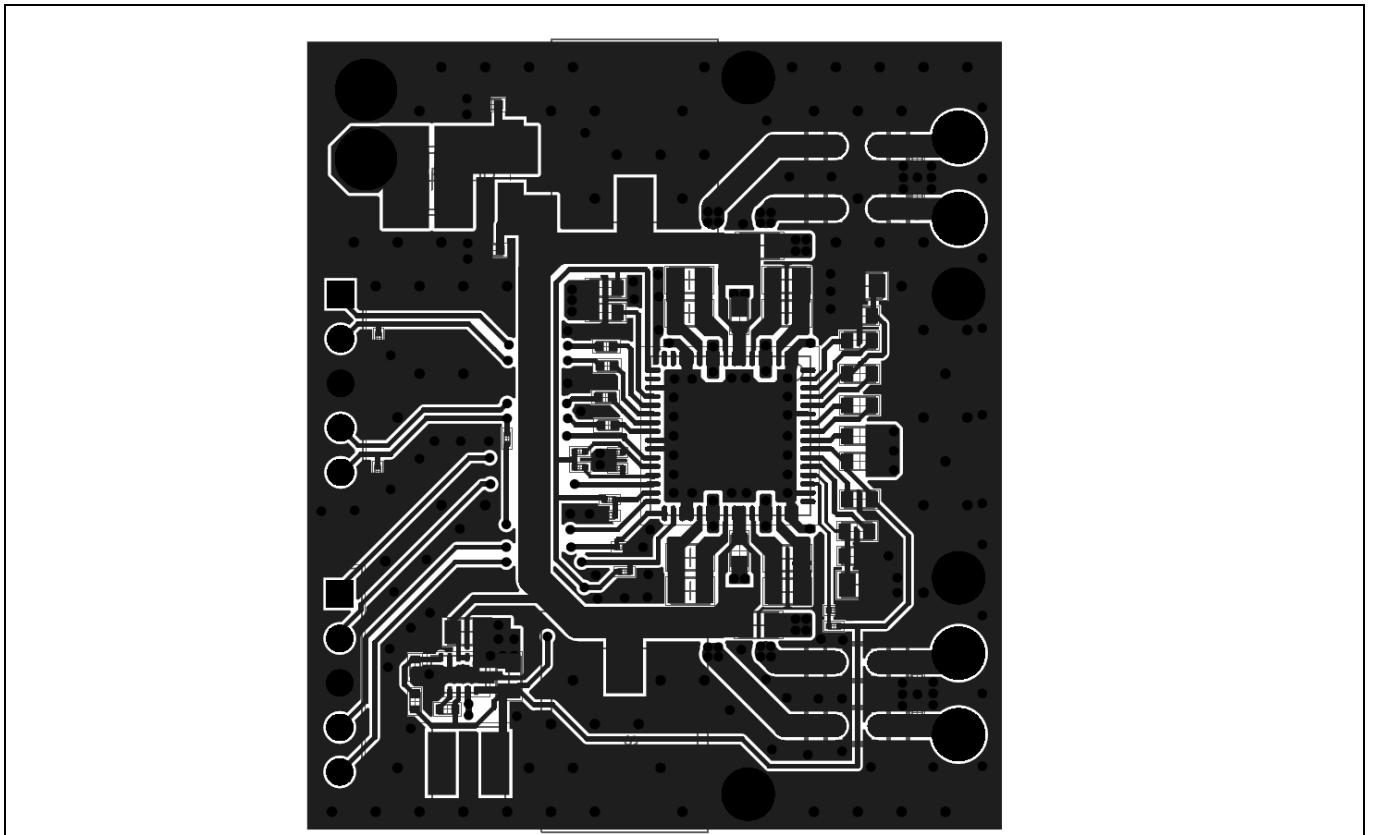

Figure 5 Top side of the PCB layout

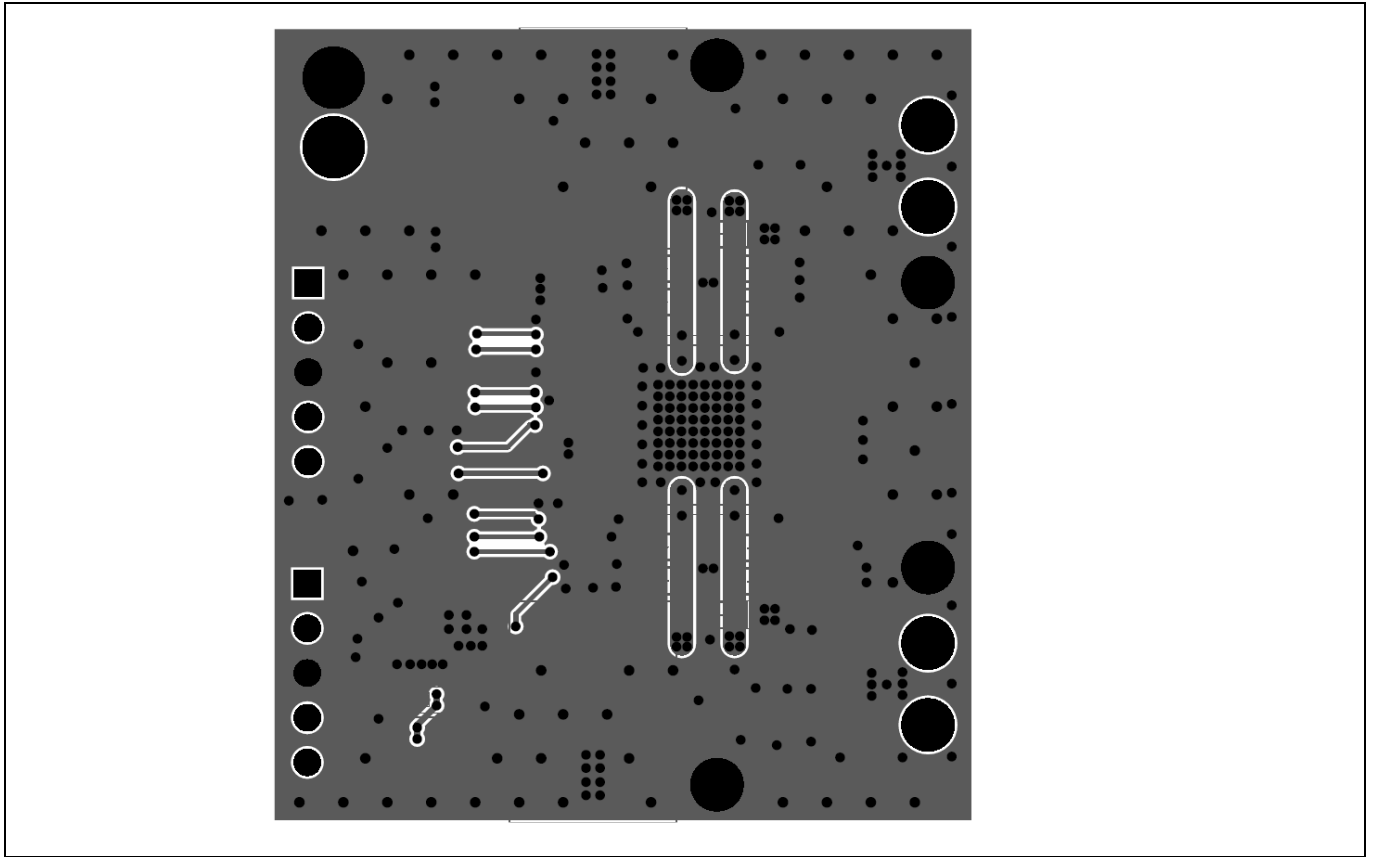

Figure 6 Bottom side of the PCB layout

The RFB is cost optimized. The cost of one module including PCB, components and assembly is estimated to be \$2.15 at a volume of 1000 pieces. The price of the MA120xx(P) amplifier depends on the volume and part. For performance optimization see the application note “EMC output filter recommendation” or contact Infineon.

Schematic, layout and design considerations

2.1 BOM

Table 1 RFB BOM

Designator	Description	Manufacturer	Part number	Quantity
C0A, C0B, C1A, C1B	CAP, 1000 pF, ±10 percent, X7R, 50 V, 0402	TDK	C1005X7R1H102K050BA	4
CAPIN0A, CAPIN0B, CAPIN1A, CAPIN1B	CAP, 1 µF, ± 10 percent, X5R, 10 V, 0402	Multicomp	MC0402X105K100CT	4
CAVDD0, CCDC, CCREf, CFDC, CGD0, CGD1, CVGDC, DVDD0	CAP, 1 µF, ± 10 percent, X7R, 25 V, 0603	Multicomp	MC0603X105K250CT	8
CF0A0, CF0A1, CF0B0, CF0B1, CF1A0, CF1A1, CF1B0, CF1B1	CAP, 10 µF, ± 10 percent, X5R, 25 V, 0805	TDK	TMK212BBJ106MG-T	8
CFGD, CGD0N0, CGD1N0, CPVDD0A, CPVDD1A	CAP, 0.1 µF, ± 10 percent, X7R, 50 V, 0603	Multicomp	MC0603B104K500CT	5
CGD0N1, CGD1N1, CPVDD0B, CPVDD1B	CAP, 1 µF, 50 V, ± 10 percent, X5R, 0805	Multicomp	MC0805X105K500CT	4
CIN0, CIN1	CAP, 0.022 µF, ± 10 percent, X7R, 50 V, 0402	Murata	GRM155R71H223KA12D	2
CINBUCK	CAP 2.2 µF 50 V ±10 percent, 0805	Taiyo Yuden	UMK212BB7225KG-T	1
COUTBUCK	CAP 22 µF 50 V ±10 percent 0805	Murata	GRM21BR61A226ME51L	1
CSUP1, CSUP2	Electrolytic cap, UWT series, 100 µF, 35 V	Nichicon	UWT1V101MCL1GS	2
LOA, LOB, L1A, L1B	SMD ferrite bead, Z = 56 Ω	Fair-Rite	2512065007Y6	4
LBUCK	SRN4026-150M	Bourns	SRN4026-100M	1
LSUP	SMD ferrite power bead, Z = 47 Ω	Fair-Rite	2743019447	1
RAD00, RAD11, RBTL, RCLK_ANA, RENABLE, RMUTE, RPBTL	Jumper 0201 (0603 metric)	Yageo	RC0201JR-070RL	7
RB_FB1	2 M 0.063 W 1 percent 0402 (1005 metric) SMD	Yageo	RC0402FR-072ML	1
RB_FB2	383 K 0.063 W 1 percent 0402 (1005 metric) SMD	Yageo	RC0402FR-07383KL	1
RB_PG	100 K 0.063 W 1 percent 0402 (1005 metric) SMD	Yageo	RC0402FR-07100KL	1
U1	Multi-level Class D amplifier	Infineon	MA120xx	1
U2	TPS62175DQCT	TI	TPS62175DQCT	1

2.2 Design considerations

The RFB is elegant because of its small form factor, while still being able to operate at up to 80 W output power per channel. This is possible due to the multi-level technology of the MA12070 and MA12070P devices.

- Thermal considerations:
 - Power-efficient operation allows heatsink-free operation because the bottom layer of the PCB design (connected to the heatsink pad of the IC) is sufficient for cool operating conditions. This holds when considering playback of real audio signals.
 - Figure 5 and Figure 6 show the top and bottom PCB design respectively. It can be seen that all the component placement and main routing is done on the top layer.
 - It is important to have as little routing as possible on the bottom layer since it needs to be optimized for thermal heat flow.
 - Routing done on the bottom layer is chosen in such a way that it still allows for good thermal heat flow. In this way, the complete bottom plate can function as a heatsink for the amplifier IC.
 - Vias placed between bottom and top ground planes add to the copper mass that functions as a heatsink.
- Filterless operation:
 - Multi-level technology also significantly reduces out-of-band noise, which allows LC filter-free operation. Only a small, SMD-sized EMI filter is needed.
 - Figure 1 shows the footprint and PCB size it takes. The board size is significantly reduced due to a small-sized EMI filter compared to a bulky LC filter.
 - The use of an LC filter is also not needed to optimize the efficiency of the amplifier. The speaker's inductive behavior is sufficient for efficient operation of the amplifier. This is again enabled by reduced out-of-band noise of the amplifier.
- Buck regulator:
 - A buck regulator (TPS62175) has been included in the design to derive a 5 V rail from the PVDD input rail. 5 V is needed as the core supply voltage for the MA120xx(P). TPS62175 has been chosen to balance the need for cost, efficiency and size. The current design of the buck regulator generates 5 V from 26 V PVDD with approximately 85 percent efficiency. Efficiency could have been increased by increasing the inductance, which would have increased the footprint; Infineon opted for a smaller footprint instead.

Measurement results

3 Measurement results

This section shows the measurement results from tests performed on a reference board, which demonstrate high audio and efficiency performance and good thermal characteristics.

Measurements include:

- Frequency sweep
- Output power sweep
- Output spectrum
- Power consumption and efficiency
- EMI

All measurement results were obtained using the following settings:

- Device: MA12070
- Two-channel BTL configuration
- Load: $4\ \Omega + 22\ \mu\text{H}$ series inductance
- PVDD: 18 V
- Gain setting: 20 dB
- PMP: default PMP0
- Measurements carried out with APx 515 + AUX-0025 input filter
- APx uses AES17 brick-wall filter (20 kHz)

3.1 Frequency sweep

Frequency sweeps were carried out with both channels at 1 W output power. To improve the gain drop at 20 Hz, use larger input capacitors.

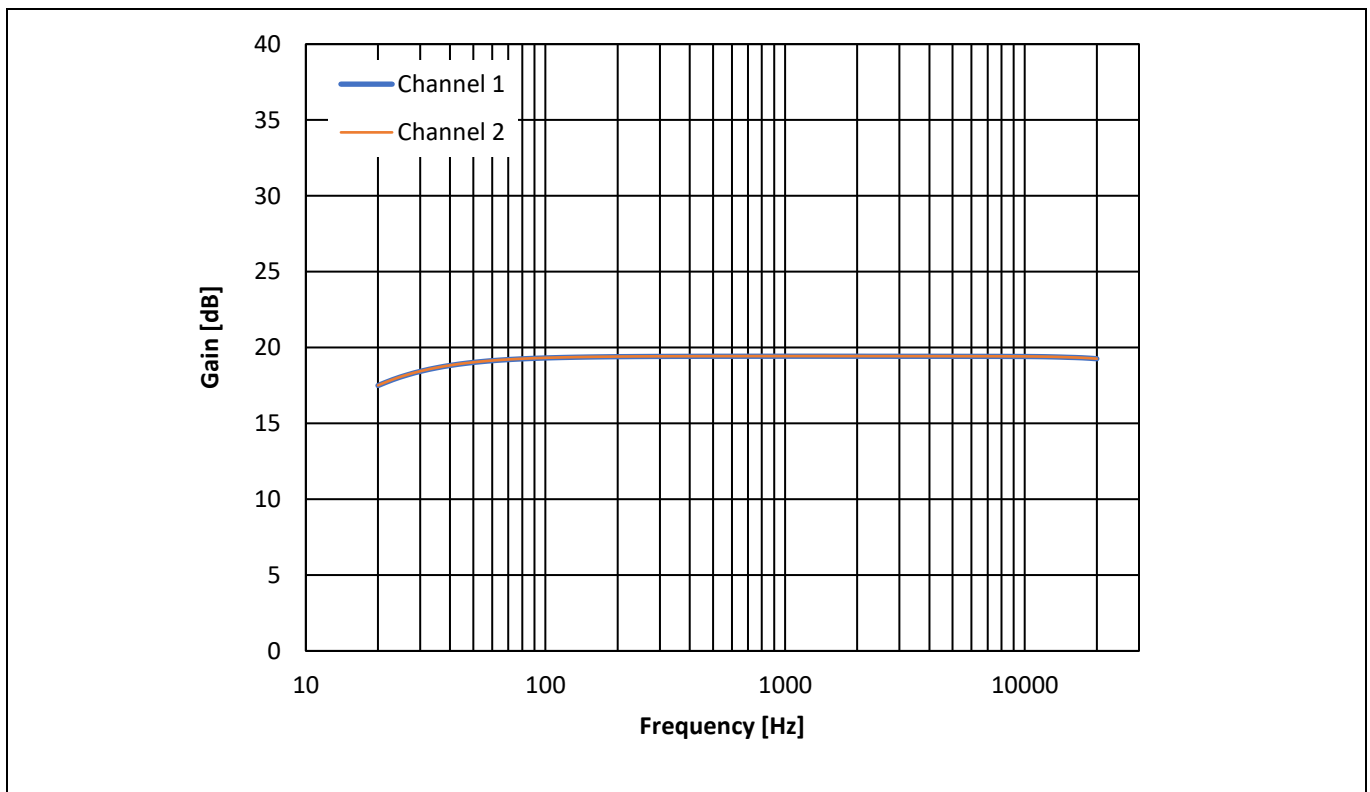

Figure 7 Gain vs. frequency

Measurement results

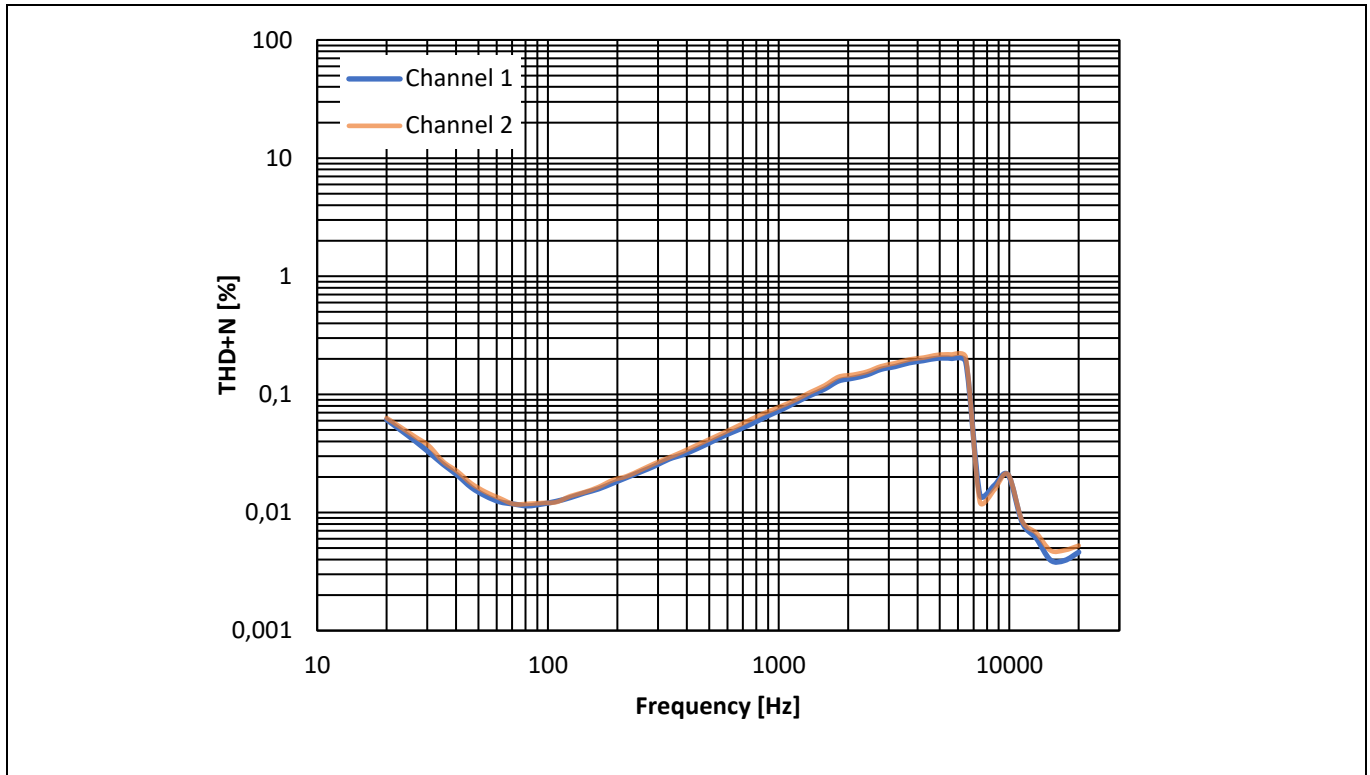

Figure 8 THD + N vs. frequency

To improve the THD + N performance use high-performance ferrite beads. See the application note – EMC output filter recommendations at www.infineon.com

Measurement results

3.2 Output power sweep

Output power sweeps were carried out on both channels with a 1 kHz input signal.

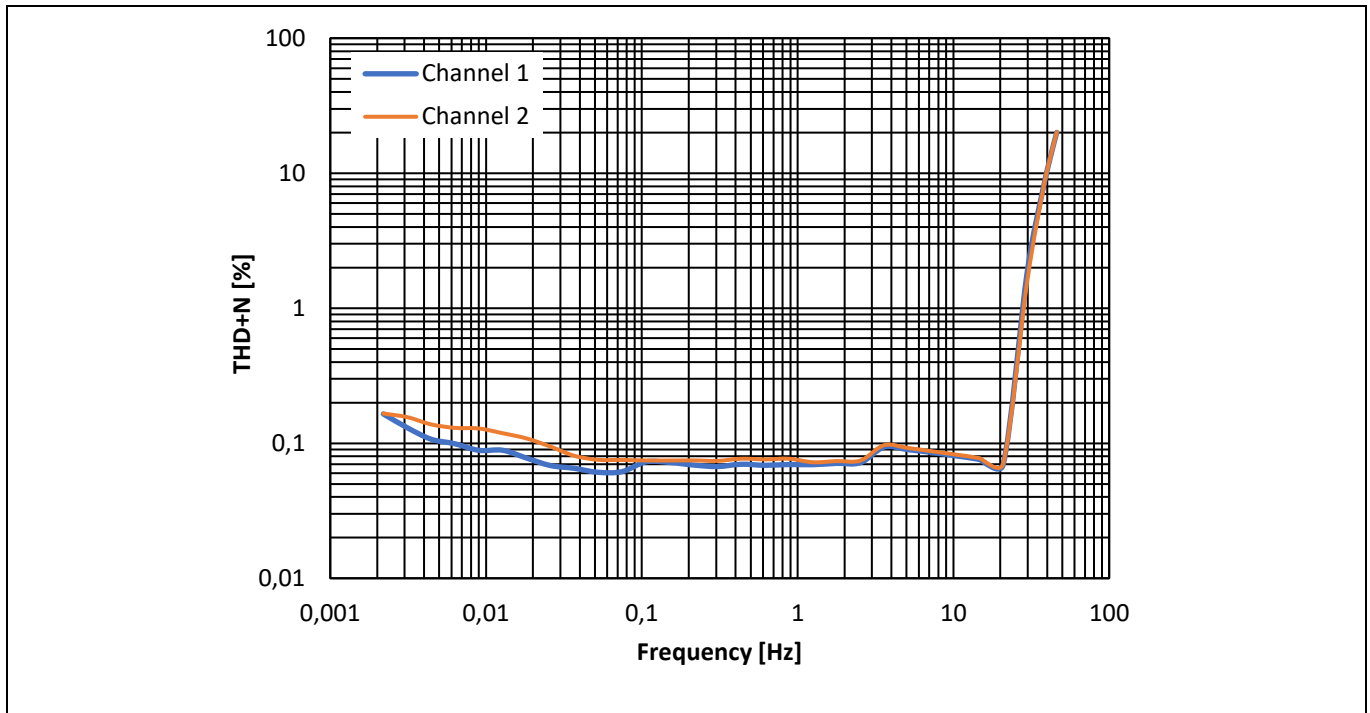

Figure 9 THD + N vs. output power

Measurement results

3.3 Output spectrum

The Figure 10 shows the output spectrum that has been obtained by applying 1 mVrms (1 kHz) input signal to both channels. This gives an output signal of -40 dBV. The noise floor for these settings is shown in the Figure 10. The integrated, A-weighted noise floor number for both channels is 70 μ Vrms (AW).

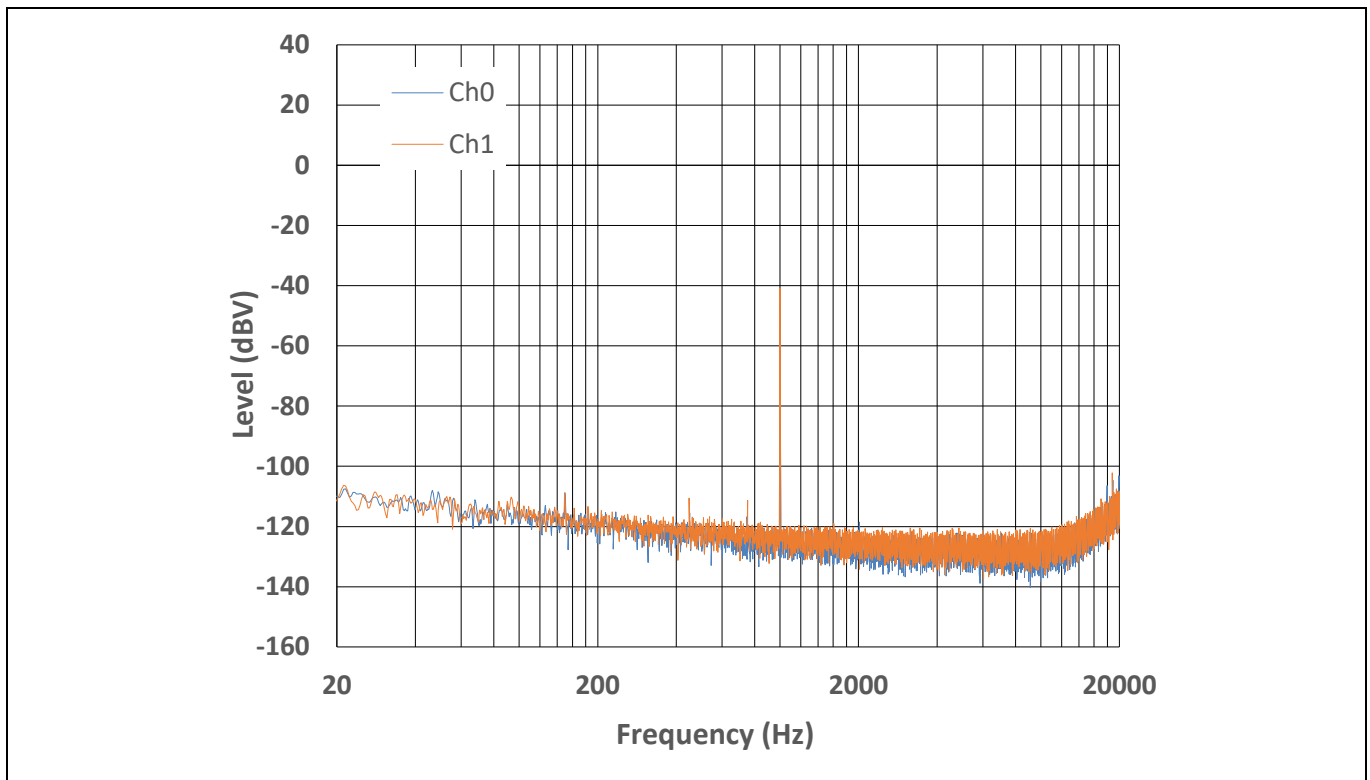

Figure 10 Output FFT spectrum

Measurement results

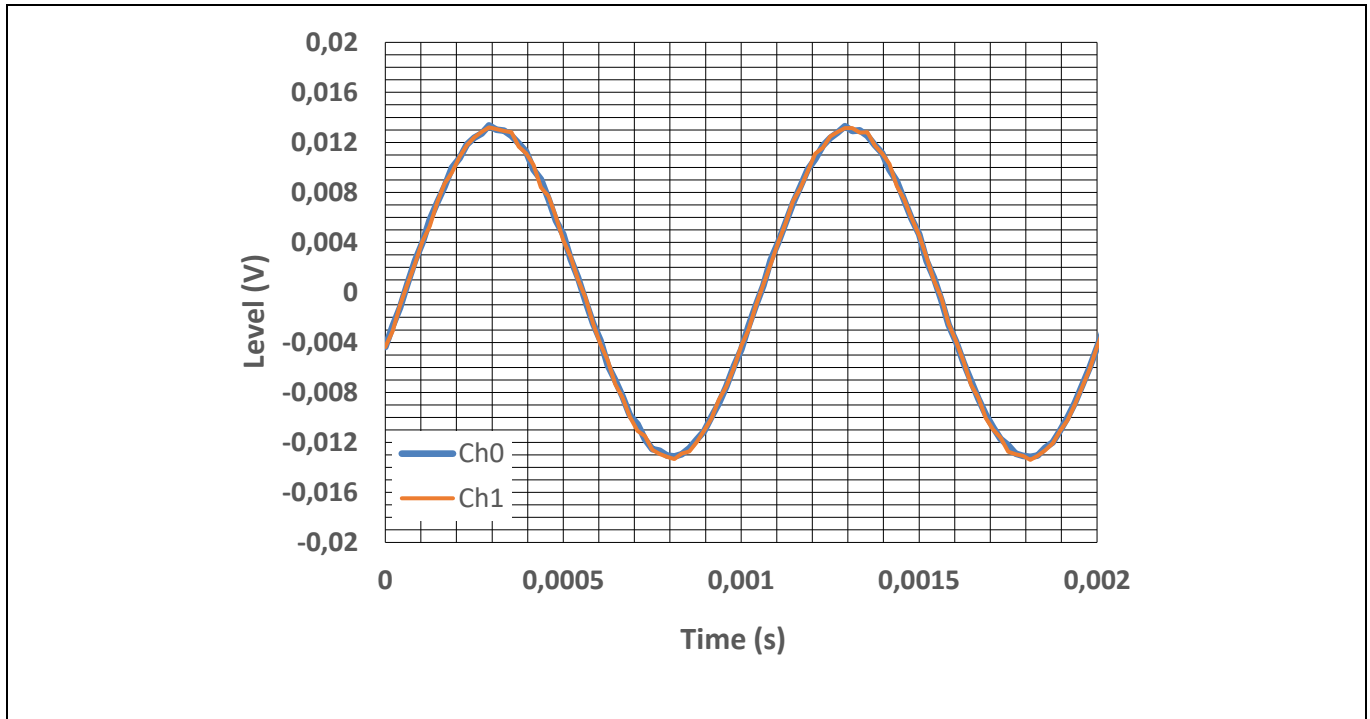

Figure 11 Scope capture showing 10 mV_{rms} output signal on both channels

3.4 Power consumption and efficiency

Power consumption and efficiency measurements were obtained by using a test signal of 1 kHz and a load of 4 Ω with 22 μH series inductance. Power consumption was calculated using the RMS method.

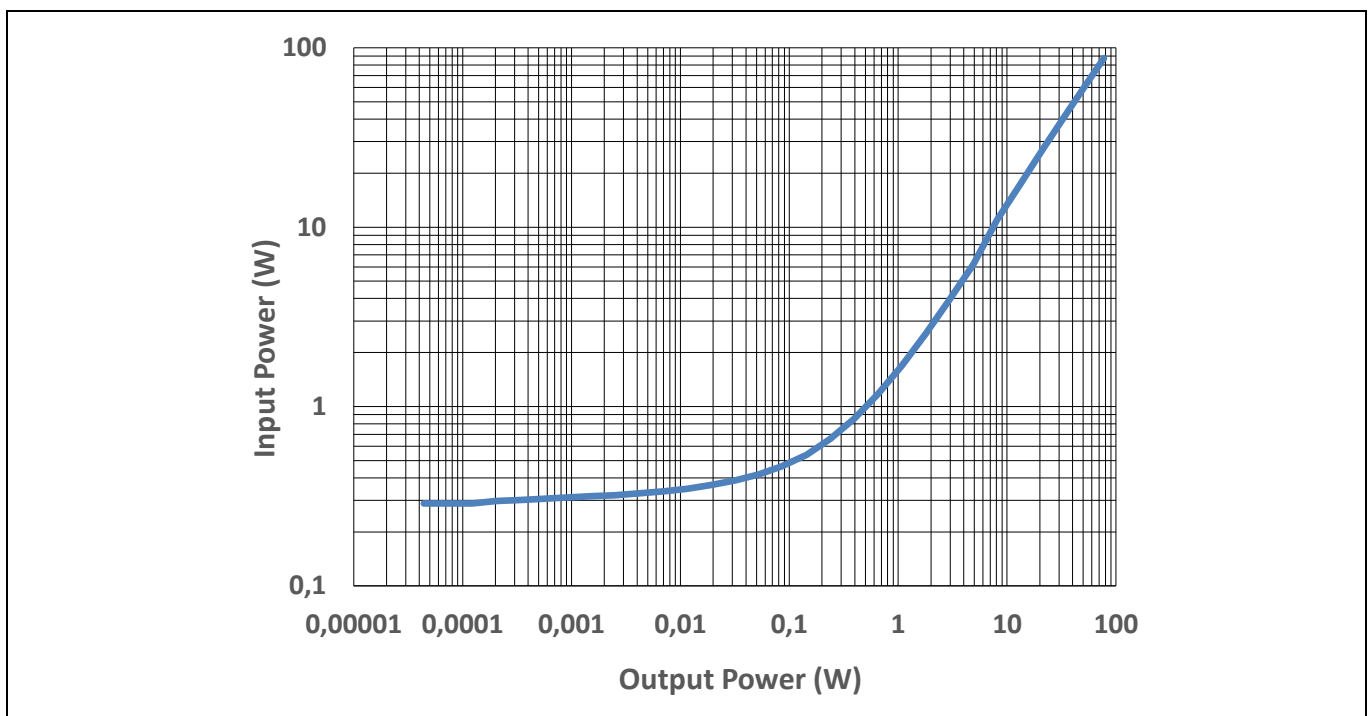

Figure 12 Input power as a function of output power

Measurement results

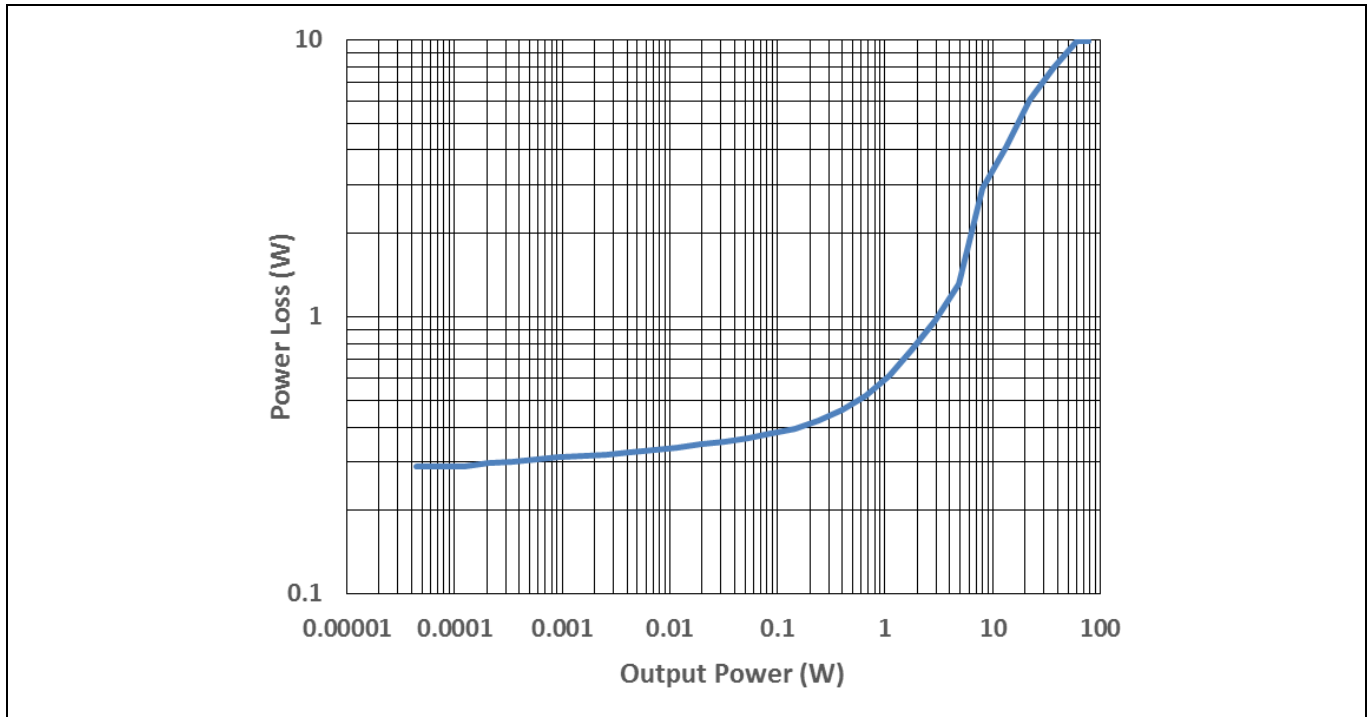

Figure 13 Power loss as a function of output power

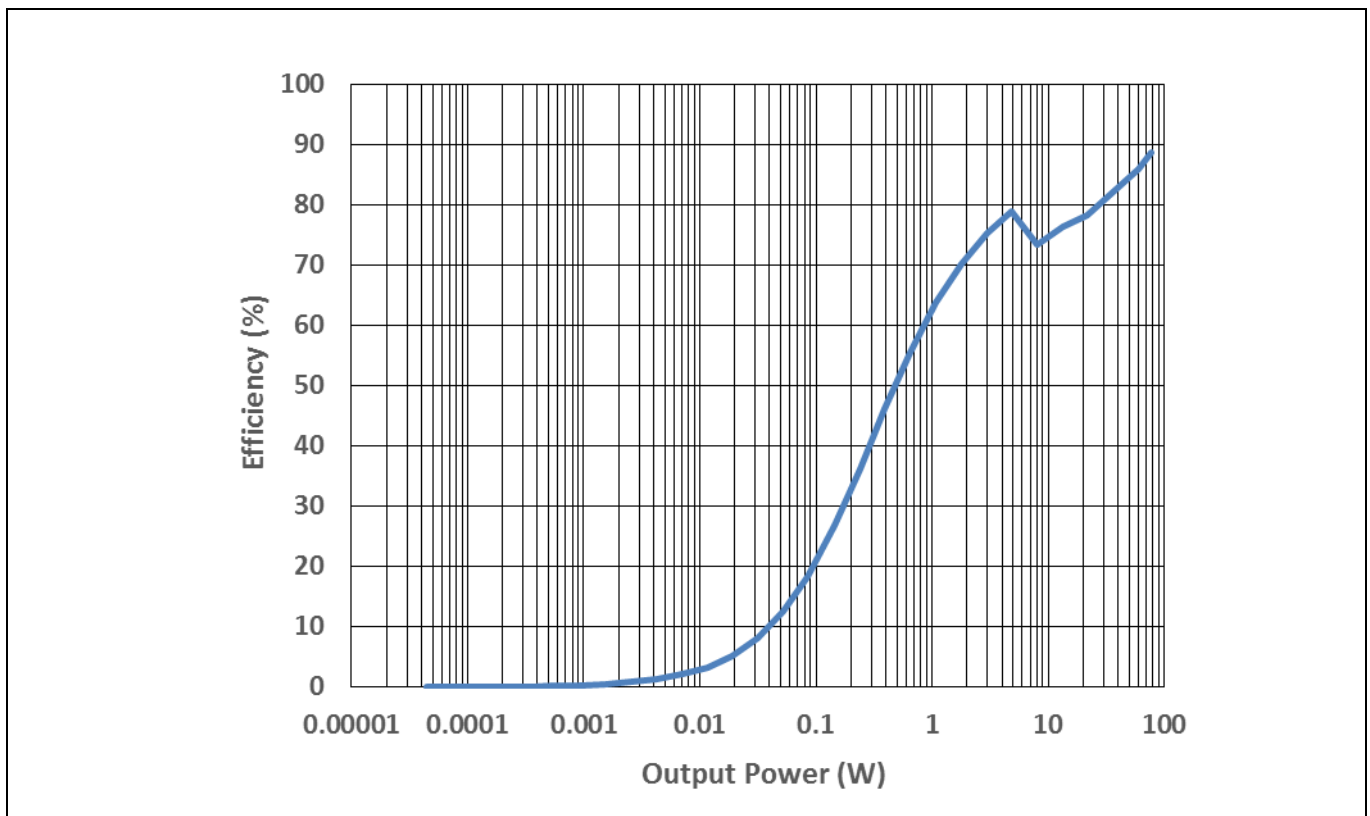

Figure 14 Efficiency as a function of output power (log scale)

Measurement results

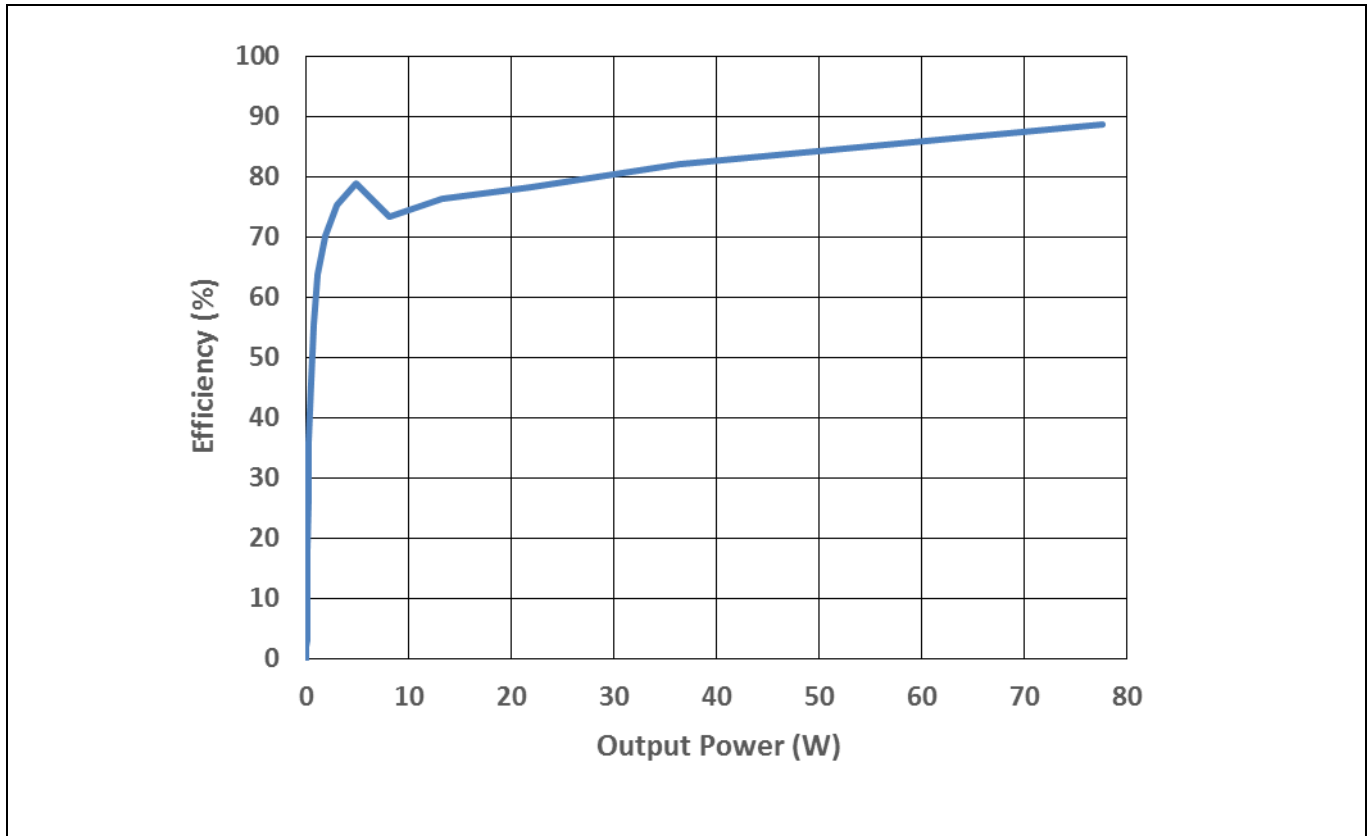

Figure 15 Efficiency as a function of output power (linear scale)

Measurement results

3.5 EMI radiated measurements

3.5.1 EMI measurement setup

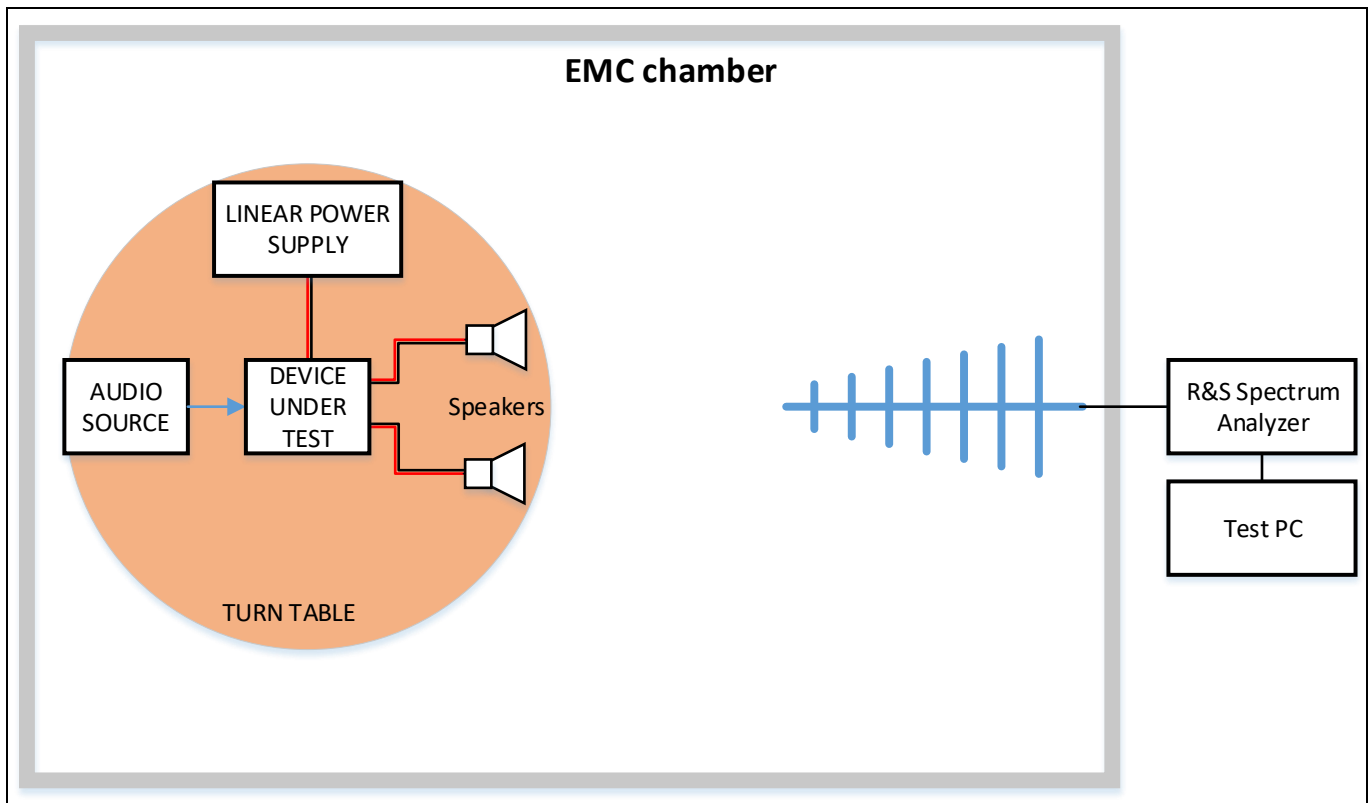

Figure 16 EMI measurement set-up for radiated emission test

Figure 16 shows the set-up for testing.

Measurement results were obtained under the following conditions:

- Linear power supply: 18 V PVDD
- Pink noise test signal output power at 20 dB gain = 1 W average output power per channel
- Speaker cable length: 10 cm
- Amplifier load: 4 Ω speaker (Visaton FR 10 WP)
- EMI filter: Murata ferrite BLE32PN300SN1L + 1 nF capacitor
- Pi filter on PVDD – Würth ferrite 74279221100 + 2 x 22 nF capacitor

3.5.2 EMI measurement results

EMI-radiated results were collected for the reference board using four scenarios:

- Board was positioned toward the antenna and the antenna was vertical (Figure 17)
- Board was positioned toward the antenna and the antenna was horizontal (Figure 18)
- Board was positioned perpendicular to the antenna and the antenna was vertical (Figure 19)
- Board was positioned perpendicular to the antenna and the antenna was horizontal (Figure 20)

Measurement results

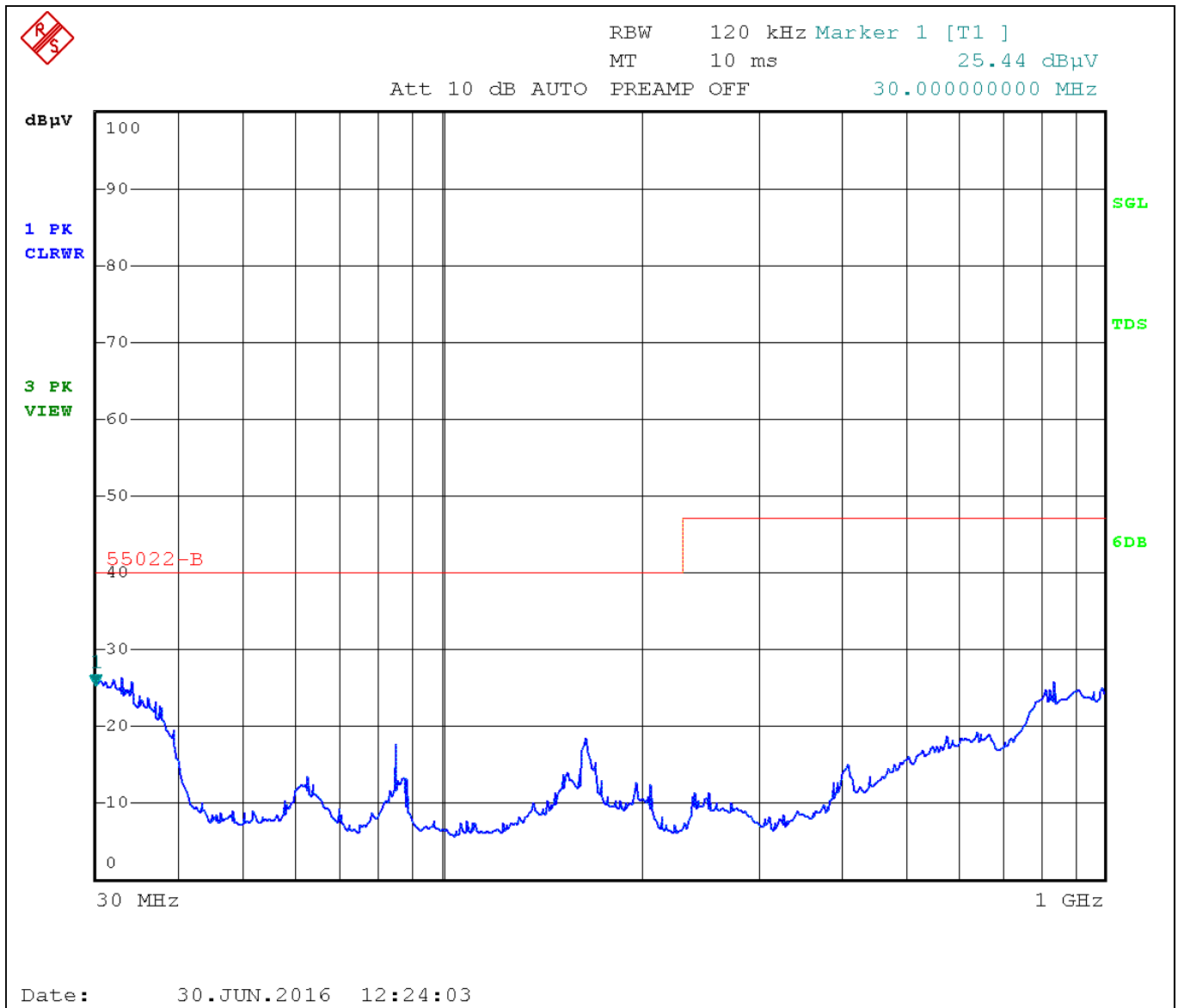

Figure 17 EMI-radiated measurement results. Board positioned toward antenna. Antenna position is vertical.

User manual for MA120xxx reference boards

Measurement results

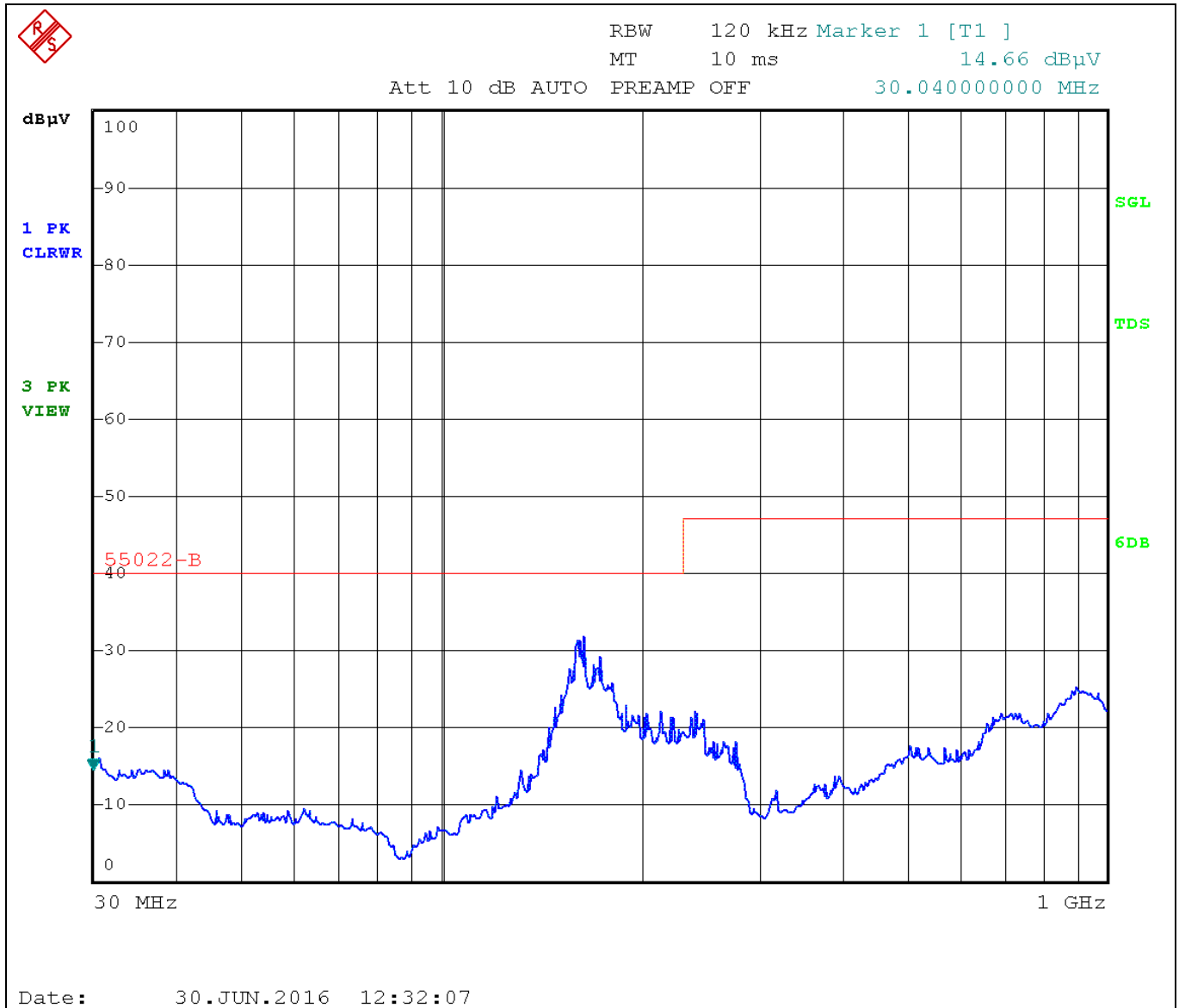

Figure 18 EMI-radiated measurement results. Board positioned toward antenna. Antenna position is horizontal.

User manual for MA120xxx reference boards

Measurement results

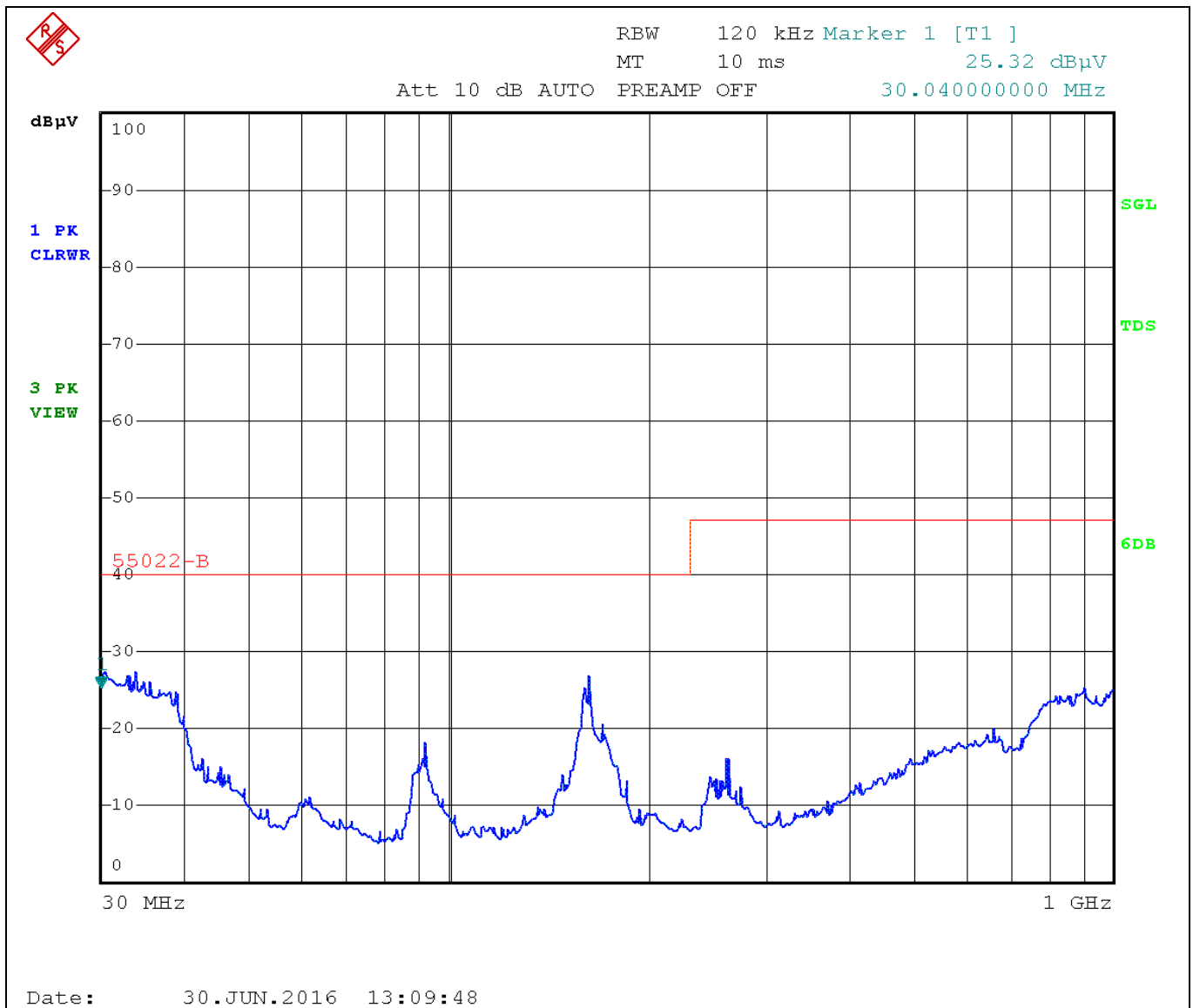

Figure 19 EMI-radiated measurement results. Board positioned perpendicular to the antenna. Antenna position is vertical.

User manual for MA120xxx reference boards

Measurement results

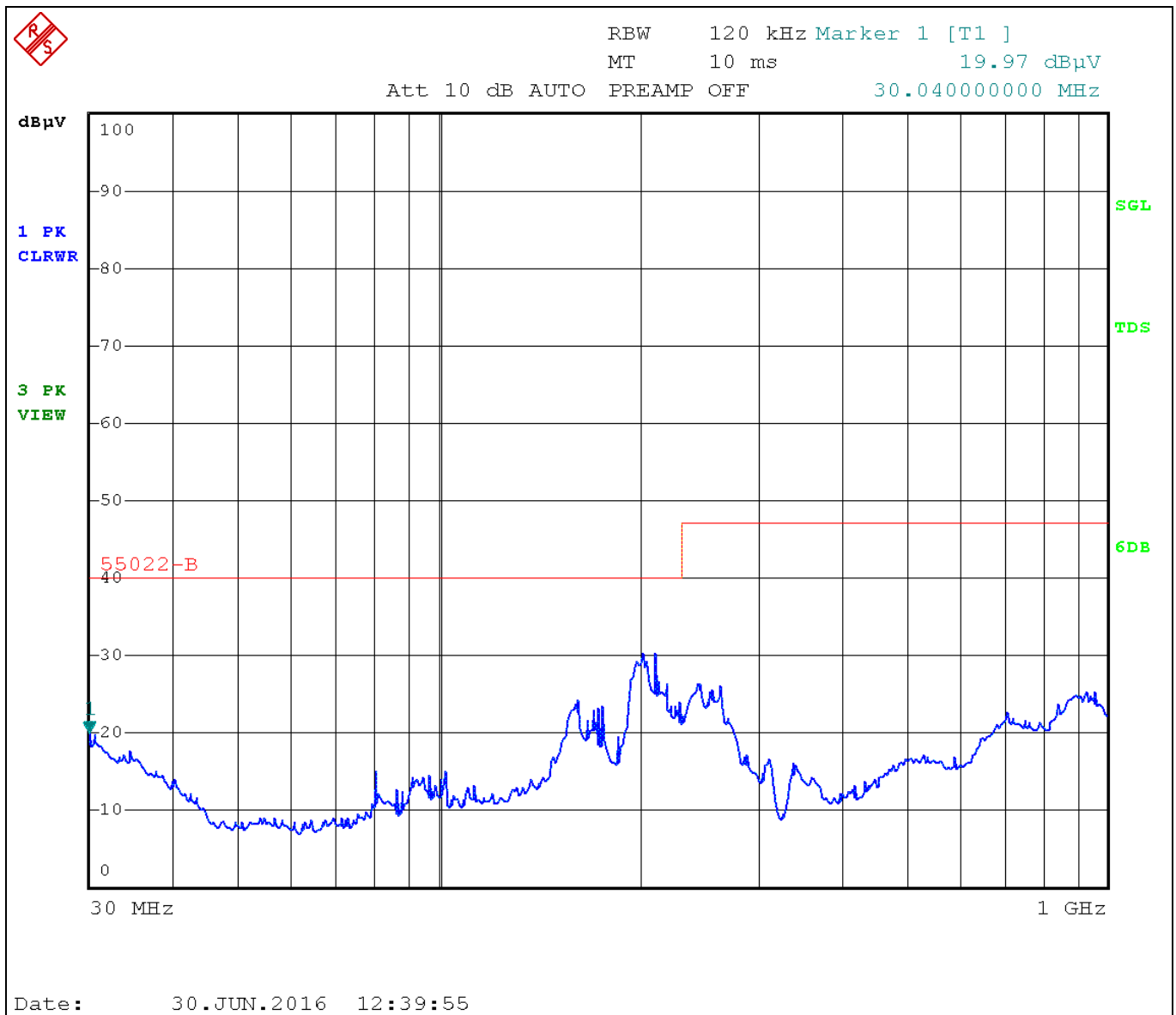

Figure 20 EMI-radiated measurement results. Board positioned perpendicular to the antenna. Antenna position is horizontal.

Appendix A – sample code

4 Appendix A – sample code

```
/*-----  
* Title: I2C basic communication set-up  
* Author: Rien Oortgiesen  
* This code demonstrates basic I2C communication  
* using Arduino UNO together with MA120XXX devices  
* Use:  
* The code uses I2C lib from Wayne Truchsess which allows repeated  
* start and can be used in an interrupt service routine  
*  
* I2C hardware config:  
* Uno breakout: SCL = A5; SDA = A4 GND = GND;  
* Reference board CONN_COM: SCL = pin 4; SDA = pin 3; GND = pin 2  
*  
* Revisions:  
* D1a: use of external lib initial test working  
* F1: final version for demonstration  
*  
* This code is free software; you can redistribute it and/or  
* modify it under the terms of the GNU Lesser General Public  
* License as published by the Free Software Foundation; either  
* version 2.1 of the License, or (at your option) any later version.  
*/  
  
#include <I2C.h>  
  
const byte LED = 13; // LED pin number  
const byte BUTTON = 2; // BUTTON pin number  
volatile int state = LOW;  
// Interrupt Service Routine (ISR)  
void switchPressed ()  
{  
  state = !state; // change state  
  digitalWrite(LED, state); //write state to LED  
  write_I2C(state); //jump to I2C handling  
}  
void setup ()  
{  
  pinMode (LED, OUTPUT); // so we can update the LED  
  digitalWrite (BUTTON, HIGH); // internal pull-up resistor
```

Appendix A – sample code

```
// attach interrupt handler (0 is the internal interrupt attached to pin 2)
attachInterrupt (0, switchPressed, RISING);

// start with LED off
digitalWrite(LED, 0);

// set audio_in_mode_ext
I2c.begin();
I2c.write(0x20,0x27,0x28); //audio_in_mode_ext = 1
I2c.end();

// set in 26dB audio_in_mode
I2c.begin();
I2c.write(0x20,0x25,0x30); //audio_in_mode = 1
I2c.end();

// set in 20dB audio_in_mode
//I2c.write(0x20,0x25,0x10); //audio_in_mode = 0
//digitalWrite(LED, 0);

} // end of setup
void loop ()
{
  // wait for interrupt
}
void write_I2C (bool dB)
{
  I2c.begin();
  if( dB == true )
  {
    I2c.write(0x20,0x25,0x30); //audio_in_mode = 1
  }
  else
  {
    I2c.write(0x20,0x25,0x10); //audio_in_mode = 0
  }
  I2c.end();
}
```

Revision history

Document version	Date of release	Description of changes
1.0	24-01-2019	Initial release

Trademarks

All referenced product or service names and trademarks are the property of their respective owners.

Edition 2019-04-28

Published by

Infineon Technologies AG

81726 Munich, Germany

© 2019 Infineon Technologies AG.

All Rights Reserved.

Do you have a question about this document?

Email: erratum@infineon.com

Document reference

UM_1902_PL88_1902_171735

IMPORTANT NOTICE

The information contained in this application note is given as a hint for the implementation of the product only and shall in no event be regarded as a description or warranty of a certain functionality, condition or quality of the product. Before implementation of the product, the recipient of this application note must verify any function and other technical information given herein in the real application. Infineon Technologies hereby disclaims any and all warranties and liabilities of any kind (including without limitation warranties of non-infringement of intellectual property rights of any third party) with respect to any and all information given in this application note.

The data contained in this document is exclusively intended for technically trained staff. It is the responsibility of customer's technical departments to evaluate the suitability of the product for the intended application and the completeness of the product information given in this document with respect to such application.

For further information on the product, technology delivery terms and conditions and prices please contact your nearest Infineon Technologies office (www.infineon.com).

WARNINGS

Due to technical requirements products may contain dangerous substances. For information on the types in question please contact your nearest Infineon Technologies office.

Except as otherwise explicitly approved by Infineon Technologies in a written document signed by authorized representatives of Infineon Technologies, Infineon Technologies' products may not be used in any applications where a failure of the product or any consequences of the use thereof can reasonably be expected to result in personal injury.