

IHM-B Modul mit soft schaltendem Trench-IGBT4
IHM-B module with soft-switching Trench-IGBT4

Vorläufige Daten / preliminary data

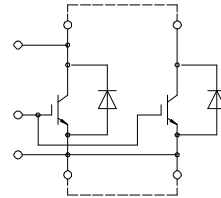

external connection
(to be done)

V_{CEs} = 1700V
I_{C nom} = 2400A / I_{CRM} = 4800A

Typische Anwendungen

- Hochleistungsumrichter
- Motorantriebe

Typical Applications

- High Power Converters
- Motor Drives

Elektrische Eigenschaften

- Erweiterte Sperrschichttemperatur T_{vj op}
- T_{vj op} = 150°C
- Niedriges V_{CEsat}

Electrical Features

- Extended Operation Temperature T_{vj op}
- T_{vj op} = 150°C
- Low V_{CEsat}

Mechanische Eigenschaften

- 4 kV AC 1min Isolationsfestigkeit
- Gehäuse mit CTI > 400
- Große Luft- und Kriechstrecken
- Hohe Leistungsdichte
- Kupferbodenplatte
- IHM B Gehäuse

Mechanical Features

- 4 kV AC 1min Insulation
- Package with CTI > 400
- High Creepage and Clearance Distances
- High Power Density
- Copper Base Plate
- IHM B Housing

Module Label Code

Barcode Code 128



DMX - Code



Content of the Code

| | Digit |
|----------------------------|--------------|
| Module Serial Number | 1 - 5 |
| Module Material Number | 6 - 11 |
| Production Order Number | 12 - 19 |
| Datecode (Production Year) | 20 - 21 |
| Datecode (Production Week) | 22 - 23 |

| | | |
|-----------------|---------------------------------|--------------------|
| prepared by: WB | date of publication: 2010-01-19 | material no: 31353 |
| approved by: IL | revision: 2.1 | |

Vorläufige Daten
preliminary data

IGBT-Wechselrichter / IGBT-inverter

Höchstzulässige Werte / maximum rated values

| | | | | |
|--|---|--------------------|-------|----|
| Kollektor-Emitter-Sperrspannung collector-emitter voltage | $T_{vj} = 25^{\circ}\text{C}$ | V_{CES} | 1700 | V |
| Kollektor-Dauergleichstrom DC-collector current | $T_C = 100^{\circ}\text{C}, T_{vj} = 175^{\circ}\text{C}$ | $I_{C\text{ nom}}$ | 2400 | A |
| Periodischer Kollektor Spitzenstrom repetitive peak collector current | $t_p = 1\text{ ms}$ | I_{CRM} | 4800 | A |
| Gesamt-Verlustleistung total power dissipation | $T_C = 25^{\circ}\text{C}, T_{vj} = 175^{\circ}\text{C}$ | P_{tot} | 14,0 | kW |
| Gate-Emitter-Spitzenspannung gate-emitter peak voltage | | V_{GES} | +/-20 | V |

Charakteristische Werte / characteristic values

| | | | min. | typ. | max. | |
|--|---|---|---------------------|----------------------|------|---|
| Kollektor-Emitter Sättigungsspannung collector-emitter saturation voltage | $I_C = 2400\text{ A}, V_{GE} = 15\text{ V}$ $I_C = 2400\text{ A}, V_{GE} = 15\text{ V}$ $I_C = 2400\text{ A}, V_{GE} = 15\text{ V}$ | $T_{vj} = 25^{\circ}\text{C}$ $T_{vj} = 125^{\circ}\text{C}$ $T_{vj} = 150^{\circ}\text{C}$ | $V_{CE\text{ sat}}$ | 1,90 2,30 2,40 | 2,25 | V V V |
| Gate-Schwellenspannung gate threshold voltage | $I_C = 96,0\text{ mA}, V_{CE} = V_{GE}, T_{vj} = 25^{\circ}\text{C}$ | | $V_{GE\text{ th}}$ | 5,2 5,8 | 6,4 | V |
| Gateladung gate charge | $V_{GE} = -15\text{ V} \dots +15\text{ V}$ | | Q_G | 25,5 | | μC |
| Interner Gatewiderstand internal gate resistor | $T_{vj} = 25^{\circ}\text{C}$ | | $R_{G\text{int}}$ | 0,81 | | Ω |
| Eingangskapazität input capacitance | $f = 1\text{ MHz}, T_{vj} = 25^{\circ}\text{C}, V_{CE} = 25\text{ V}, V_{GE} = 0\text{ V}$ | | C_{ies} | 195 | | nF |
| Rückwirkungskapazität reverse transfer capacitance | $f = 1\text{ MHz}, T_{vj} = 25^{\circ}\text{C}, V_{CE} = 25\text{ V}, V_{GE} = 0\text{ V}$ | | C_{res} | 6,30 | | nF |
| Kollektor-Emitter Reststrom collector-emitter cut-off current | $V_{CE} = 1700\text{ V}, V_{GE} = 0\text{ V}, T_{vj} = 25^{\circ}\text{C}$ | | I_{CES} | | 5,0 | mA |
| Gate-Emitter Reststrom gate-emitter leakage current | $V_{CE} = 0\text{ V}, V_{GE} = 20\text{ V}, T_{vj} = 25^{\circ}\text{C}$ | | I_{GES} | | 400 | nA |
| Einschaltverzögerungszeit (ind. Last) turn-on delay time (inductive load) | $I_C = 2400\text{ A}, V_{CE} = 900\text{ V}$ $V_{GE} = \pm 15\text{ V}$ $R_{G\text{on}} = 0,4\ \Omega$ | $T_{vj} = 25^{\circ}\text{C}$ $T_{vj} = 125^{\circ}\text{C}$ $T_{vj} = 150^{\circ}\text{C}$ | $t_{d\text{ on}}$ | 0,65 0,73 0,79 | | μs μs μs |
| Anstiegszeit (induktive Last) rise time (inductive load) | $I_C = 2400\text{ A}, V_{CE} = 900\text{ V}$ $V_{GE} = \pm 15\text{ V}$ $R_{G\text{on}} = 0,4\ \Omega$ | $T_{vj} = 25^{\circ}\text{C}$ $T_{vj} = 125^{\circ}\text{C}$ $T_{vj} = 150^{\circ}\text{C}$ | t_r | 0,20 0,21 0,22 | | μs μs μs |
| Abschaltverzögerungszeit (ind. Last) turn-off delay time (inductive load) | $I_C = 2400\text{ A}, V_{CE} = 900\text{ V}$ $V_{GE} = \pm 15\text{ V}$ $R_{G\text{off}} = 0,5\ \Omega$ | $T_{vj} = 25^{\circ}\text{C}$ $T_{vj} = 125^{\circ}\text{C}$ $T_{vj} = 150^{\circ}\text{C}$ | $t_{d\text{ off}}$ | 1,30 1,40 1,45 | | μs μs μs |
| Fallzeit (induktive Last) fall time (inductive load) | $I_C = 2400\text{ A}, V_{CE} = 900\text{ V}$ $V_{GE} = \pm 15\text{ V}$ $R_{G\text{off}} = 0,5\ \Omega$ | $T_{vj} = 25^{\circ}\text{C}$ $T_{vj} = 125^{\circ}\text{C}$ $T_{vj} = 150^{\circ}\text{C}$ | t_f | 0,19 0,33 0,36 | | μs μs μs |
| Einschaltverlustenergie pro Puls turn-on energy loss per pulse | $I_C = 2400\text{ A}, V_{CE} = 900\text{ V}, L_S = 50\text{ nH}$ $V_{GE} = \pm 15\text{ V}, di/dt = 11000\text{ A}/\mu\text{s} (T_{vj}=150^{\circ}\text{C})$ $R_{G\text{on}} = 0,4\ \Omega$ | $T_{vj} = 25^{\circ}\text{C}$ $T_{vj} = 125^{\circ}\text{C}$ $T_{vj} = 150^{\circ}\text{C}$ | E_{on} | 405 570 625 | | mJ mJ mJ |
| Abschaltverlustenergie pro Puls turn-off energy loss per pulse | $I_C = 2400\text{ A}, V_{CE} = 900\text{ V}, L_S = 50\text{ nH}$ $V_{GE} = \pm 15\text{ V}, du/dt = 2800\text{ V}/\mu\text{s} (T_{vj}=150^{\circ}\text{C})$ $R_{G\text{off}} = 0,5\ \Omega$ | $T_{vj} = 25^{\circ}\text{C}$ $T_{vj} = 125^{\circ}\text{C}$ $T_{vj} = 150^{\circ}\text{C}$ | E_{off} | 660 830 880 | | mJ mJ mJ |
| Kurzschlussverhalten SC data | $V_{GE} \leq 15\text{ V}, V_{CC} = 1000\text{ V}$ $V_{CE\text{ max}} = V_{CES} - L_{SCE} \cdot di/dt$ $t_p \leq 10\ \mu\text{s}, T_{vj} = 150^{\circ}\text{C}$ | | I_{SC} | 9500 | | A |
| Innerer Wärmewiderstand thermal resistance, junction to case | pro IGBT / per IGBT | | R_{thJC} | | 11,0 | K/kW |
| Übergangs-Wärmewiderstand thermal resistance, case to heatsink | pro IGBT / per IGBT $\lambda_{\text{Paste}} = 1\text{ W}/(\text{m}\cdot\text{K})$ / $\lambda_{\text{grease}} = 1\text{ W}/(\text{m}\cdot\text{K})$ | | R_{thCH} | 9,45 | | K/kW |

| | |
|-----------------|---------------------------------|
| prepared by: WB | date of publication: 2010-01-19 |
| approved by: IL | revision: 2.1 |

Vorläufige Daten
preliminary data

Diode-Wechselrichter / diode-inverter

Höchstzulässige Werte / maximum rated values

| | | | | |
|---|--|----------------------|------------|--|
| Periodische Spitzensperrspannung repetitive peak reverse voltage | $T_{vj} = 25^{\circ}\text{C}$ | V_{RRM} | 1700 | V |
| Dauergleichstrom DC forward current | | I_F | 2400 | A |
| Periodischer Spitzenstrom repetitive peak forward current | $t_p = 1 \text{ ms}$ | I_{FRM} | 4800 | A |
| Grenzlastintegral I^2t - value | $V_R = 0 \text{ V}, t_p = 10 \text{ ms}, T_{vj} = 125^{\circ}\text{C}$ $V_R = 0 \text{ V}, t_p = 10 \text{ ms}, T_{vj} = 150^{\circ}\text{C}$ | I^2t | 835 790 | kA^2s kA^2s |
| Spitzenverlustleistung maximum power dissipation | $T_{vj} = 125^{\circ}\text{C}$ | P_{RQM} | 2400 | kW |
| Mindesteinschaltzeit minimum turn-on time | | $t_{on \text{ min}}$ | 10,0 | μs |

Charakteristische Werte / characteristic values

| | | | min. | typ. | max. | |
|---|---|--------------------------------|-----------|------|------|---------------|
| Durchlassspannung forward voltage | $I_F = 2400 \text{ A}, V_{GE} = 0 \text{ V}$ | $T_{vj} = 25^{\circ}\text{C}$ | | 1,80 | 2,20 | V |
| | $I_F = 2400 \text{ A}, V_{GE} = 0 \text{ V}$ | $T_{vj} = 125^{\circ}\text{C}$ | V_F | 1,90 | | V |
| | $I_F = 2400 \text{ A}, V_{GE} = 0 \text{ V}$ | $T_{vj} = 150^{\circ}\text{C}$ | | 1,95 | | V |
| Rückstromspitze peak reverse recovery current | $I_F = 2400 \text{ A}, -di_F/dt = 11000 \text{ A}/\mu\text{s} (T_{vj}=150^{\circ}\text{C})$ $V_R = 900 \text{ V}$ $V_{GE} = -15 \text{ V}$ | $T_{vj} = 25^{\circ}\text{C}$ | | 2250 | | A |
| | | $T_{vj} = 125^{\circ}\text{C}$ | I_{RM} | 2600 | | A |
| | | $T_{vj} = 150^{\circ}\text{C}$ | | 2600 | | A |
| Sperrverzögerungsladung recovered charge | $I_F = 2400 \text{ A}, -di_F/dt = 11000 \text{ A}/\mu\text{s} (T_{vj}=150^{\circ}\text{C})$ $V_R = 900 \text{ V}$ $V_{GE} = -15 \text{ V}$ | $T_{vj} = 25^{\circ}\text{C}$ | | 570 | | μC |
| | | $T_{vj} = 125^{\circ}\text{C}$ | Q_r | 970 | | μC |
| | | $T_{vj} = 150^{\circ}\text{C}$ | | 1100 | | μC |
| Abschaltenergie pro Puls reverse recovery energy | $I_F = 2400 \text{ A}, -di_F/dt = 11000 \text{ A}/\mu\text{s} (T_{vj}=150^{\circ}\text{C})$ $V_R = 900 \text{ V}$ $V_{GE} = -15 \text{ V}$ | $T_{vj} = 25^{\circ}\text{C}$ | | 390 | | mJ |
| | | $T_{vj} = 125^{\circ}\text{C}$ | E_{rec} | 690 | | mJ |
| | | $T_{vj} = 150^{\circ}\text{C}$ | | 780 | | mJ |
| Innerer Wärmewiderstand thermal resistance, junction to case | pro Diode / per diode | R_{thJC} | | | 20,0 | K/kW |
| Übergangs-Wärmewiderstand thermal resistance, case to heatsink | pro Diode / per diode $\lambda_{\text{Paste}} = 1 \text{ W}/(\text{m}\cdot\text{K}) / \lambda_{\text{grease}} = 1 \text{ W}/(\text{m}\cdot\text{K})$ | R_{thCH} | | 10,5 | | K/kW |

| | |
|-----------------|---------------------------------|
| prepared by: WB | date of publication: 2010-01-19 |
| approved by: IL | revision: 2.1 |

Technische Information / technical information

IGBT-Module
IGBT-modules

FZ2400R17HP4



Vorläufige Daten preliminary data

Modul / module

| | | | | | |
|--|---|----------------------|--------------------------------|------|---------|
| Isolations-Prüfspannung insulation test voltage | RMS, f = 50 Hz, t = 1 min. | V _{ISO} | 4,0 | | kV |
| Material Modulgrundplatte material of module baseplate | | | Cu | | |
| Material für innere Isolation material for internal insulation | | | Al ₂ O ₃ | | |
| Kriechstrecke creepage distance | Kontakt - Kühlkörper / terminal to heatsink Kontakt - Kontakt / terminal to terminal | | 32,2 32,2 | | mm |
| Luftstrecke clearance distance | Kontakt - Kühlkörper / terminal to heatsink Kontakt - Kontakt / terminal to terminal | | 19,1 19,1 | | mm |
| Vergleichszahl der Kriechwegbildung comparative tracking index | | CTI | > 400 | | |
| | | | min. | typ. | max. |
| Modulinduktivität stray inductance module | | L _{sCE} | | 9,0 | nH |
| Modulleitungswiderstand, Anschlüsse - Chip module lead resistance, terminals - chip | T _C = 25°C, pro Schalter / per switch | R _{CC'+EE'} | | 0,13 | mΩ |
| Höchstzulässige Sperrschichttemperatur maximum junction temperature | Wechselrichter, Brems-Chopper / Inverter, Brake-Chopper | T _{vj max} | | | 175 °C |
| Temperatur im Schaltbetrieb temperature under switching conditions | Wechselrichter, Brems-Chopper / Inverter, Brake-Chopper | T _{vj op} | -40 | | 150 °C |
| Lagertemperatur storage temperature | | T _{stg} | -40 | | 150 °C |
| Anzugsdrehmoment f. mech. Befestigung mounting torque | Schraube M6 - Montage gem. gültiger Applikation Note screw M6 - mounting according to valid application note | M | 4,25 | - | 5,75 Nm |
| Anzugsdrehmoment f. elektr. Anschlüsse terminal connection torque | Schraube M4 - Montage gem. gültiger Applikation Note Schraube M8 - Montage gem. gültiger Applikation Note screw M8 - mounting according to valid application note | M | 1,8 | - | 2,1 Nm |
| | | | 8,0 | - | 10 Nm |
| Gewicht weight | | G | | 1300 | g |

| | |
|-----------------|---------------------------------|
| prepared by: WB | date of publication: 2010-01-19 |
| approved by: IL | revision: 2.1 |

Vorläufige Daten
preliminary data

Ausgangskennlinie IGBT-Wechselr. (typisch)
output characteristic IGBT-inverter (typical)
 $I_c = f(V_{CE})$
 $V_{GE} = 15\text{ V}$

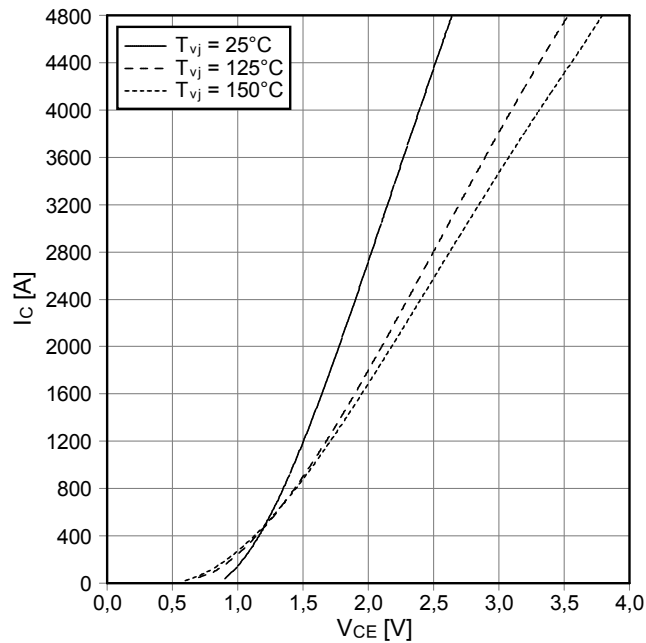

Ausgangskennlinienfeld IGBT-Wechselr. (typisch)
output characteristic IGBT-inverter (typical)
 $I_c = f(V_{CE})$
 $T_{vj} = 150^\circ\text{C}$

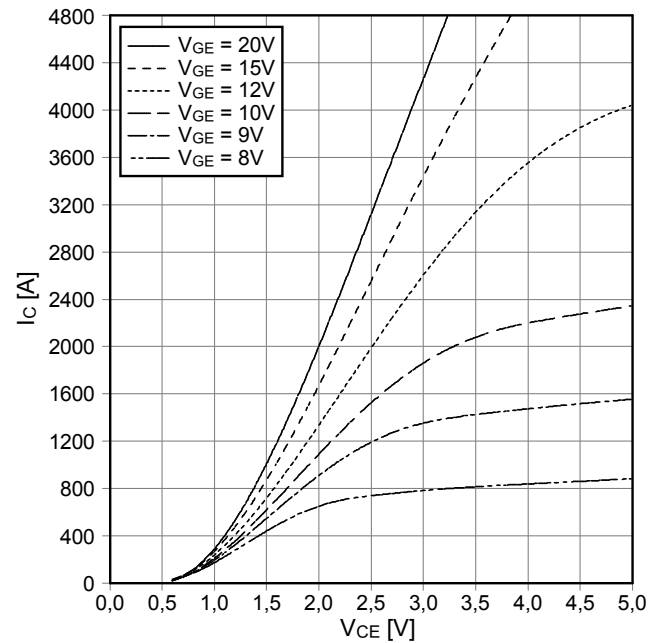

Übertragungscharakteristik IGBT-Wechselr. (typisch)
transfer characteristic IGBT-inverter (typical)
 $I_c = f(V_{GE})$
 $V_{CE} = 20\text{ V}$

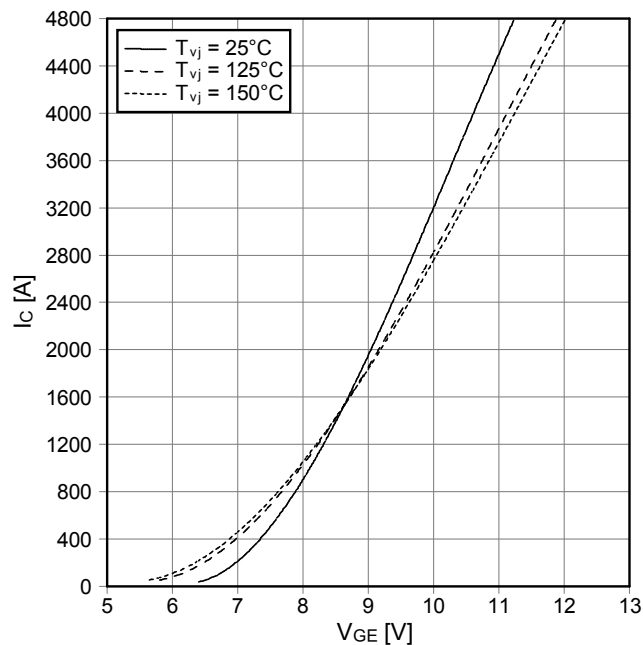

Schaltverluste IGBT-Wechselr. (typisch)
switching losses IGBT-inverter (typical)
 $E_{on} = f(I_c)$, $E_{off} = f(I_c)$
 $V_{GE} = \pm 15\text{ V}$, $R_{Gon} = 0.4\ \Omega$, $R_{Goff} = 0.5\ \Omega$, $V_{CE} = 900\text{ V}$

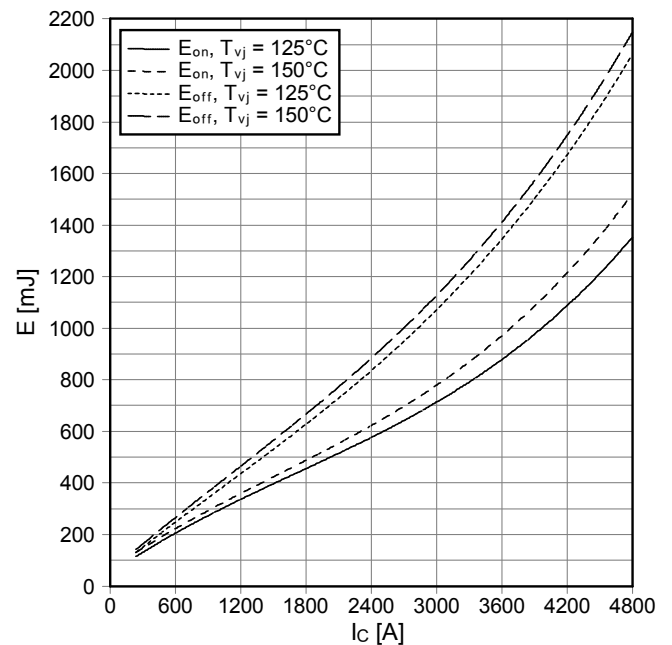

| | |
|-----------------|---------------------------------|
| prepared by: WB | date of publication: 2010-01-19 |
| approved by: IL | revision: 2.1 |

Vorläufige Daten
preliminary data

Schaltverluste IGBT-Wechselr. (typisch)
switching losses IGBT-inverter (typical)
 $E_{on} = f(R_G)$, $E_{off} = f(R_G)$
 $V_{GE} = \pm 15\text{ V}$, $I_C = 2400\text{ A}$, $V_{CE} = 900\text{ V}$

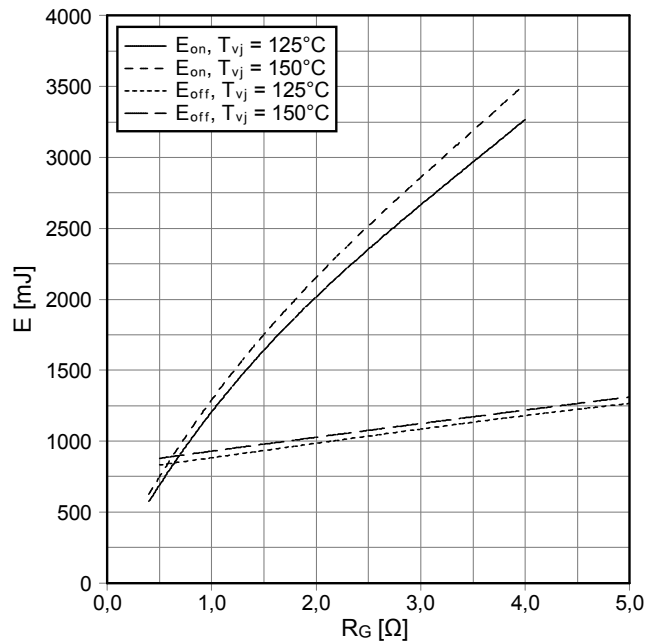

Transienter Wärmewiderstand IGBT-Wechselr.
transient thermal impedance IGBT-inverter
 $Z_{thJC} = f(t)$

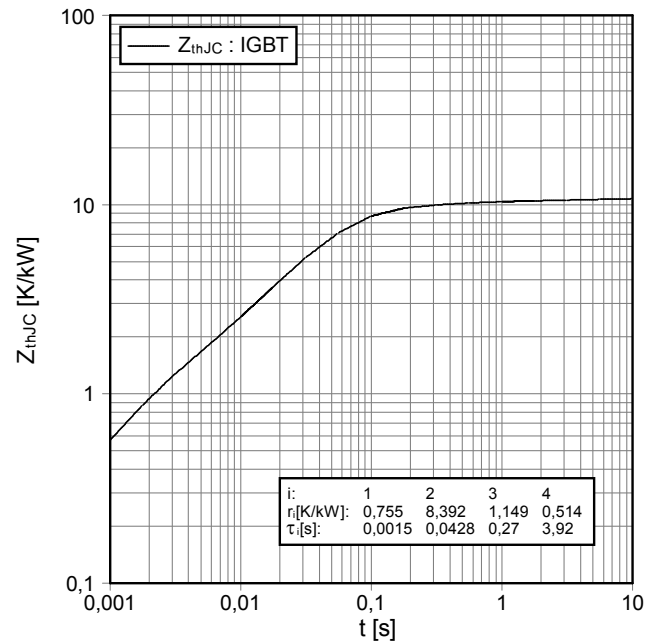

Sicherer Rückwärts-Arbeitsbereich IGBT-Wr. (RBSOA)
reverse bias safe operating area IGBT-inv. (RBSOA)
 $I_C = f(V_{CE})$
 $V_{GE} = \pm 15\text{ V}$, $R_{Goff} = 0.5\ \Omega$, $T_{vj} = 150^\circ\text{C}$

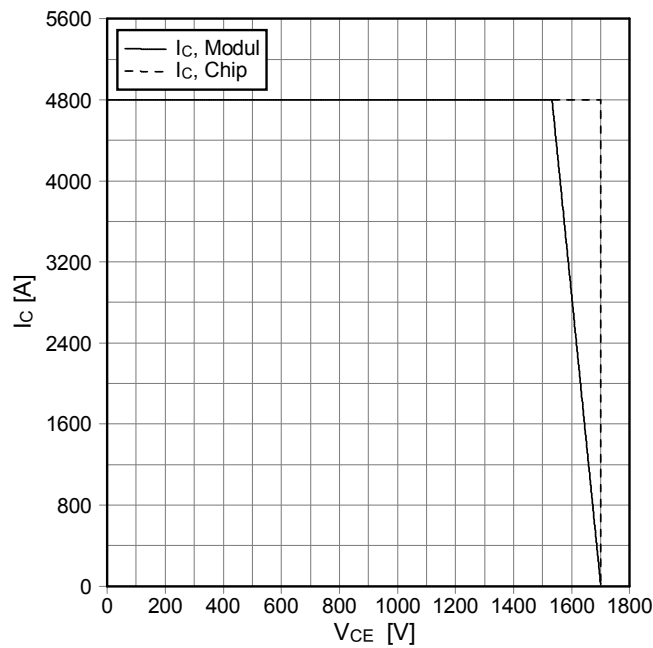

Durchlasskennlinie der Diode-Wechselr. (typisch)
forward characteristic of diode-inverter (typical)
 $I_F = f(V_F)$

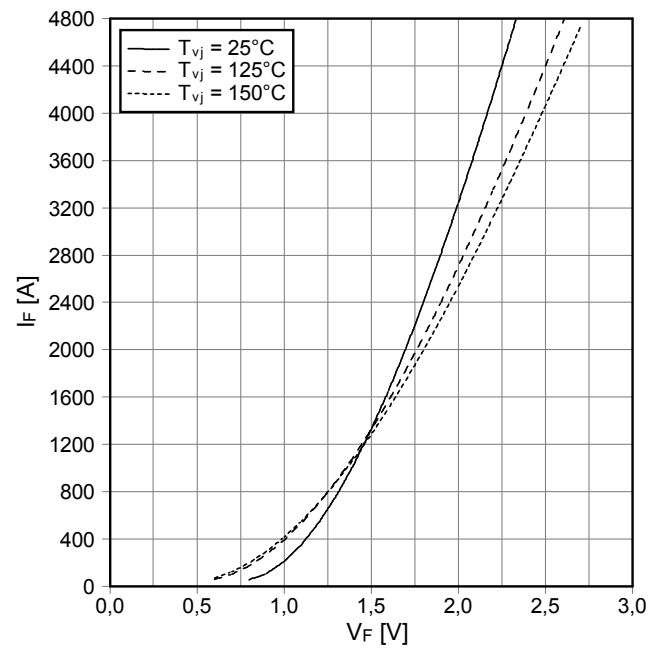

| | |
|-----------------|---------------------------------|
| prepared by: WB | date of publication: 2010-01-19 |
| approved by: IL | revision: 2.1 |

Vorläufige Daten
preliminary data

Schaltverluste Diode-Wechselr. (typisch)
switching losses diode-inverter (typical)

$E_{rec} = f(I_F)$
 $R_{Gon} = 0.4 \Omega, V_{CE} = 900 V$

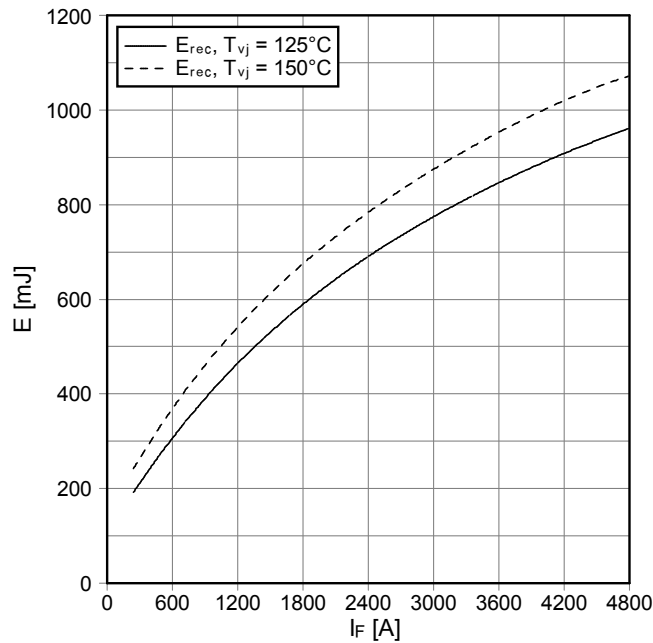

Schaltverluste Diode-Wechselr. (typisch)
switching losses diode-inverter (typical)

$E_{rec} = f(R_G)$
 $I_F = 2400 A, V_{CE} = 900 V$

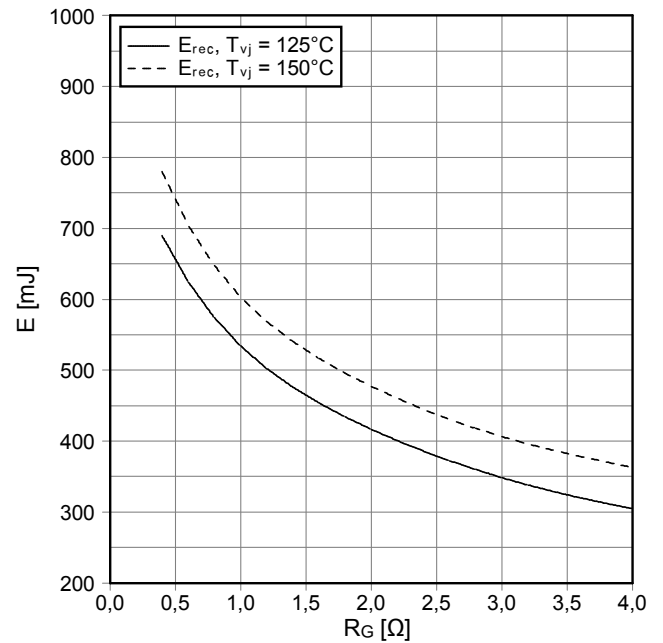

Transienter Wärmewiderstand Diode-Wechselr.
transient thermal impedance diode-inverter

$Z_{thJC} = f(t)$

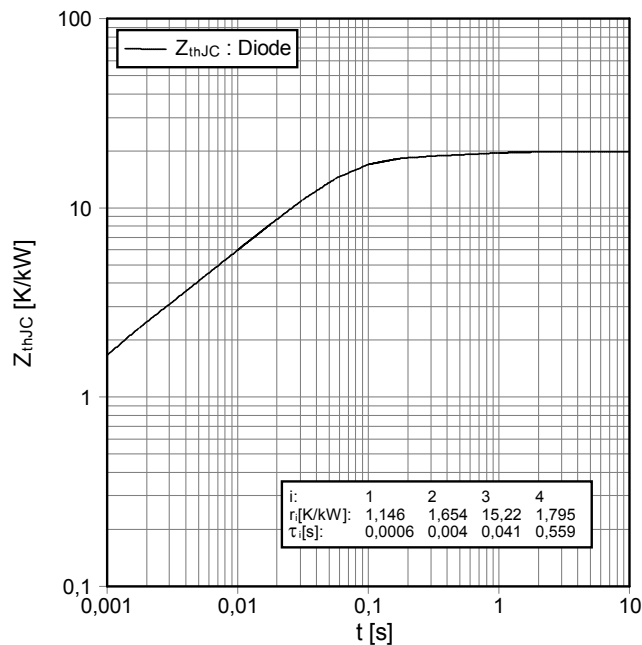

Sicherer Arbeitsbereich Diode-Wechselr. (SOA)
safe operation area diode-inverter (SOA)

$I_R = f(V_R)$
 $T_{vj} = 150^\circ C$

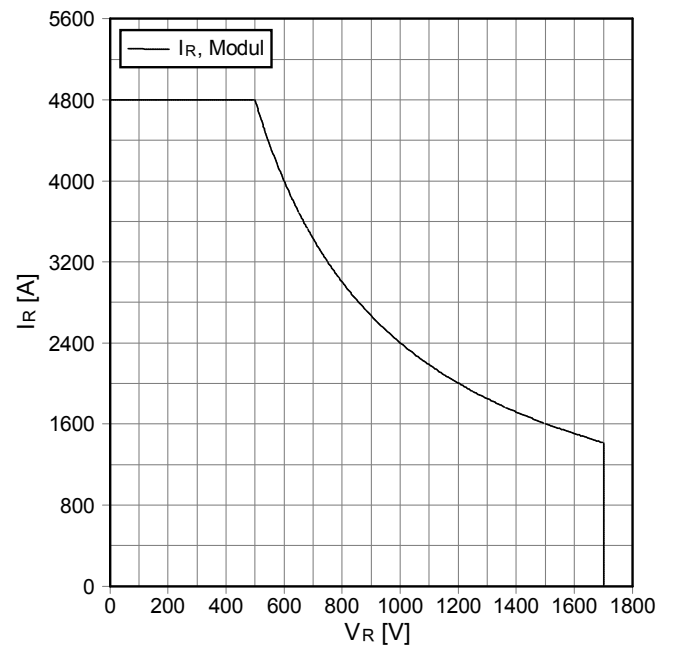

| | |
|-----------------|---------------------------------|
| prepared by: WB | date of publication: 2010-01-19 |
| approved by: IL | revision: 2.1 |

Schaltplan / circuit diagram

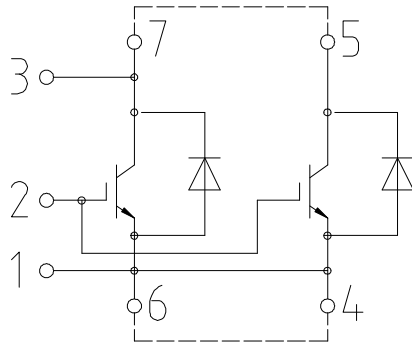

external connection
(to be done)

Gehäuseabmessungen / package outlines

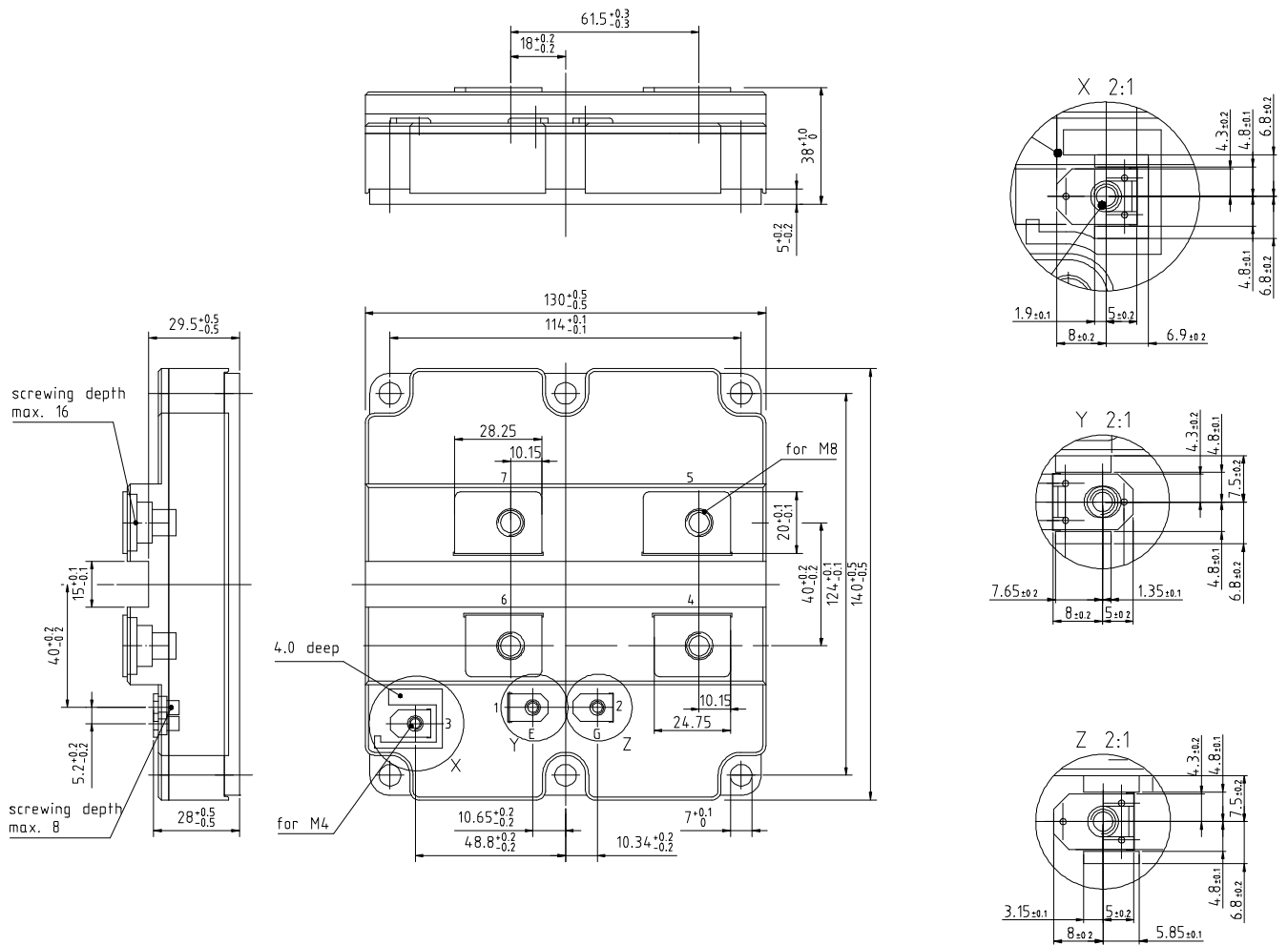

| | |
|-----------------|---------------------------------|
| prepared by: WB | date of publication: 2010-01-19 |
| approved by: IL | revision: 2.1 |



Nutzungsbedingungen

Die in diesem Produktdatenblatt enthaltenen Daten sind ausschließlich für technisch geschultes Fachpersonal bestimmt. Die Beurteilung der Eignung dieses Produktes für Ihre Anwendung sowie die Beurteilung der Vollständigkeit der bereitgestellten Produktdaten für diese Anwendung obliegt Ihnen bzw. Ihren technischen Abteilungen.

In diesem Produktdatenblatt werden diejenigen Merkmale beschrieben, für die wir eine liefervertragliche Gewährleistung übernehmen. Eine solche Gewährleistung richtet sich ausschließlich nach Maßgabe der im jeweiligen Liefervertrag enthaltenen Bestimmungen. Garantien jeglicher Art werden für das Produkt und dessen Eigenschaften keinesfalls übernommen.

Sollten Sie von uns Produktinformationen benötigen, die über den Inhalt dieses Produktdatenblatts hinausgehen und insbesondere eine spezifische Verwendung und den Einsatz dieses Produktes betreffen, setzen Sie sich bitte mit dem für Sie zuständigen Vertriebsbüro in Verbindung (siehe www.infineon.com, Vertrieb&Kontakt). Für Interessenten halten wir Application Notes bereit.

Aufgrund der technischen Anforderungen könnte unser Produkt gesundheitsgefährdende Substanzen enthalten. Bei Rückfragen zu den in diesem Produkt jeweils enthaltenen Substanzen setzen Sie sich bitte ebenfalls mit dem für Sie zuständigen Vertriebsbüro in Verbindung.

Sollten Sie beabsichtigen, das Produkt in Anwendungen der Luftfahrt, in gesundheits- oder lebensgefährdenden oder lebenserhaltenden Anwendungsbereichen einzusetzen, bitten wir um Mitteilung. Wir weisen darauf hin, dass wir für diese Fälle

- die gemeinsame Durchführung eines Risiko- und Qualitätsassessments;
- den Abschluss von speziellen Qualitätssicherungsvereinbarungen;
- die gemeinsame Einführung von Maßnahmen zu einer laufenden Produktbeobachtung dringend empfehlen und gegebenenfalls die Belieferung von der Umsetzung solcher Maßnahmen abhängig machen.

Soweit erforderlich, bitten wir Sie, entsprechende Hinweise an Ihre Kunden zu geben.

Inhaltliche Änderungen dieses Produktdatenblatts bleiben vorbehalten.

Terms & Conditions of usage

The data contained in this product data sheet is exclusively intended for technically trained staff. You and your technical departments will have to evaluate the suitability of the product for the intended application and the completeness of the product data with respect to such application.

This product data sheet is describing the characteristics of this product for which a warranty is granted. Any such warranty is granted exclusively pursuant the terms and conditions of the supply agreement. There will be no guarantee of any kind for the product and its characteristics.

Should you require product information in excess of the data given in this product data sheet or which concerns the specific application of our product, please contact the sales office, which is responsible for you (see www.infineon.com, sales&contact). For those that are specifically interested we may provide application notes.

Due to technical requirements our product may contain dangerous substances. For information on the types in question please contact the sales office, which is responsible for you.

Should you intend to use the Product in aviation applications, in health or live endangering or life support applications, please notify. Please note, that for any such applications we urgently recommend

- to perform joint Risk and Quality Assessments;
- the conclusion of Quality Agreements;
- to establish joint measures of an ongoing product survey, and that we may make delivery depended on the realization of any such measures.

If and to the extent necessary, please forward equivalent notices to your customers.

Changes of this product data sheet are reserved.

| | |
|-----------------|---------------------------------|
| prepared by: WB | date of publication: 2010-01-19 |
| approved by: IL | revision: 2.1 |