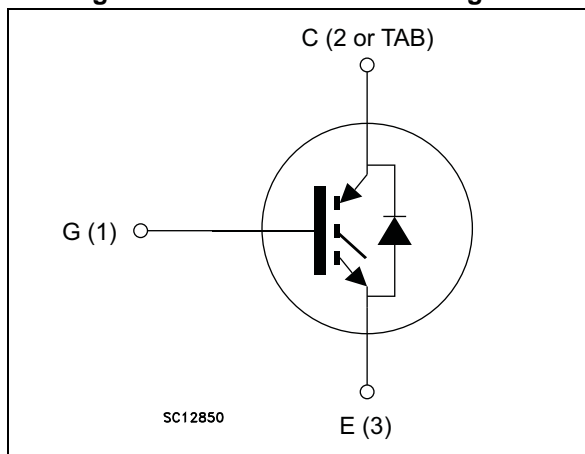

Figure 1. Internal schematic diagram



### Features

- Maximum junction temperature:  $T_J = 175\text{ °C}$
- Tail-less switching off
- $V_{CE(sat)} = 1.85\text{ V (typ.) @ } I_C = 60\text{ A}$
- Tight parameter distribution
- Safe paralleling
- Low thermal resistance
- Very fast soft recovery antiparallel diode

### Applications

- Photovoltaic inverters
- Uninterruptible power supply
- Welding
- Power factor correction
- Very high frequency converters

### Description

These devices are IGBTs developed using an advanced proprietary trench gate field-stop structure. These devices are part of the V series of IGBTs, which represents an optimum compromise between conduction and switching losses to maximize the efficiency of very high frequency converters. Furthermore, a positive  $V_{CE(sat)}$  temperature coefficient and very tight parameter distribution result in safer paralleling operation.

Table 1. Device summary

Order code	Marking	Package	Packing
STGW60V60DF	GW60V60DF	TO-247	Tube
STGWA60V60DF	G60V60DF	TO-247 long leads	Tube
STGWT60V60DF	GWT60V60DF	TO-3P	Tube

# Contents

- 1      Electrical ratings ..... 3**
- 2      Electrical characteristics ..... 4**
  - 2.1    Electrical characteristics (curves) ..... 6
- 3      Test circuits ..... 11**
- 4      Package information ..... 12**
  - 4.1    TO-247 package information ..... 13
  - 4.2    TO-247 long leads package information ..... 15
  - 4.3    TO-3P package information ..... 17
- 5      Revision history ..... 19**



# 1 Electrical ratings

**Table 2. Absolute maximum ratings**

Symbol	Parameter	Value	Unit
$V_{CES}$	Collector-emitter voltage ( $V_{GE} = 0$ )	600	V
$I_C$	Continuous collector current at $T_C = 25\text{ °C}$	80 <sup>(1)</sup>	A
$I_C$	Continuous collector current at $T_C = 100\text{ °C}$	60	A
$I_{CP}$ <sup>(2)</sup>	Pulsed collector current	240	A
$V_{GE}$	Gate-emitter voltage	$\pm 20$	V
$I_F$	Continuous forward current at $T_C = 25\text{ °C}$	80 <sup>(1)</sup>	A
$I_F$	Continuous forward current at $T_C = 100\text{ °C}$	60	A
$I_{FP}$ <sup>(2)</sup>	Pulsed forward current	240	A
$P_{TOT}$	Total dissipation at $T_C = 25\text{ °C}$	375	W
$T_{STG}$	Storage temperature range	- 55 to 150	°C
$T_J$	Operating junction temperature range	- 55 to 175	°C

1. Current level is limited by bond wires
2. Pulse width limited by maximum junction temperature.

**Table 3. Thermal data**

Symbol	Parameter	Value	Unit
$R_{thJC}$	Thermal resistance junction-case IGBT	0.4	°C/W
$R_{thJC}$	Thermal resistance junction-case diode	1.14	°C/W
$R_{thJA}$	Thermal resistance junction-ambient	50	°C/W

## 2 Electrical characteristics

$T_J = 25\text{ °C}$  unless otherwise specified.

**Table 4. Static characteristics**

Symbol	Parameter	Test conditions	Min.	Typ.	Max.	Unit
$V_{(BR)CES}$	Collector-emitter breakdown voltage ( $V_{GE} = 0$ )	$I_C = 2\text{ mA}$	600			V
$V_{CE(sat)}$	Collector-emitter saturation voltage	$V_{GE} = 15\text{ V}, I_C = 60\text{ A}$		1.85	2.3	V
		$V_{GE} = 15\text{ V}, I_C = 60\text{ A}$ $T_J = 125\text{ °C}$		2.15		
		$V_{GE} = 15\text{ V}, I_C = 60\text{ A}$ $T_J = 175\text{ °C}$		2.35		
$V_F$	Forward on-voltage	$I_F = 60\text{ A}$		2	2.6	V
		$I_F = 60\text{ A}, T_J = 125\text{ °C}$		1.7		V
		$I_F = 60\text{ A}, T_J = 175\text{ °C}$		1.6		V
$V_{GE(th)}$	Gate threshold voltage	$V_{CE} = V_{GE}, I_C = 1\text{ mA}$	5	6	7	V
$I_{CES}$	Collector cut-off current ( $V_{GE} = 0$ )	$V_{CE} = 600\text{ V}$			25	$\mu\text{A}$
$I_{GES}$	Gate-emitter leakage current ( $V_{CE} = 0$ )	$V_{GE} = \pm 20\text{ V}$			$\pm 250$	nA

**Table 5. Dynamic characteristics**

Symbol	Parameter	Test conditions	Min.	Typ.	Max.	Unit
$C_{ies}$	Input capacitance	$V_{CE} = 25\text{ V}, f = 1\text{ MHz},$ $V_{GE} = 0$	-	8000	-	pF
$C_{oes}$	Output capacitance		-	280	-	pF
$C_{res}$	Reverse transfer capacitance		-	170	-	pF
$Q_g$	Total gate charge	$V_{CC} = 480\text{ V}, I_C = 60\text{ A},$ $V_{GE} = 15\text{ V},$ see <a href="#">Figure 29</a>	-	334	-	nC
$Q_{ge}$	Gate-emitter charge		-	130	-	nC
$Q_{gc}$	Gate-collector charge		-	58	-	nC

Table 6. IGBT switching characteristics (inductive load)

Symbol	Parameter	Test conditions	Min.	Typ.	Max.	Unit
$t_{d(on)}$	Turn-on delay time	$V_{CE} = 400\text{ V}$ , $I_C = 60\text{ A}$ , $R_G = 4.7\ \Omega$ , $V_{GE} = 15\text{ V}$ , see <a href="#">Figure 28</a>	-	60	-	ns
$t_r$	Current rise time		-	20	-	ns
$(di/dt)_{on}$	Turn-on current slope		-	2365	-	A/ $\mu$ s
$t_{d(off)}$	Turn-off delay time		-	208	-	ns
$t_f$	Current fall time		-	14	-	ns
$E_{on}^{(1)}$	Turn-on switching energy		-	0.75	-	mJ
$E_{off}^{(2)}$	Turn-off switching energy		-	0.55	-	mJ
$E_{ts}$	Total switching energy	-	1.3	-	mJ	
$t_{d(on)}$	Turn-on delay time	$V_{CE} = 400\text{ V}$ , $I_C = 60\text{ A}$ , $R_G = 4.7\ \Omega$ , $V_{GE} = 15\text{ V}$ , $T_J = 175\text{ }^\circ\text{C}$ , see <a href="#">Figure 28</a>	-	57	-	ns
$t_r$	Current rise time		-	23	-	ns
$(di/dt)_{on}$	Turn-on current slope		-	2191	-	A/ $\mu$ s
$t_{d(off)}$	Turn-off delay time		-	216	-	ns
$t_f$	Current fall time		-	27	-	ns
$E_{on}^{(1)}$	Turn-on switching energy		-	1.5	-	mJ
$E_{off}^{(2)}$	Turn-off switching energy		-	0.8	-	mJ
$E_{ts}$	Total switching energy	-	2.3	-	mJ	

1. Including the reverse recovery of the diode.

2. Including the tail of the collector current.

Table 7. Diode switching characteristics (inductive load)

Symbol	Parameter	Test conditions	Min.	Typ.	Max.	Unit
$t_{rr}$	Reverse recovery time	$I_F = 60\text{ A}$ , $V_R = 400\text{ V}$ , $V_{GE} = 15\text{ V}$ , $di_F/dt = 1000\text{ A}/\mu\text{s}$ see <a href="#">Figure 28</a>	-	74	-	ns
$Q_{rr}$	Reverse recovery charge		-	703	-	nC
$I_{rrm}$	Reverse recovery current		-	19	-	A
$dl_{rr}/dt$	Peak rate of fall of reverse recovery current during $t_b$		-	714	-	A/ $\mu$ s
$E_{rr}$	Reverse recovery energy		-	184	-	$\mu$ J
$t_{rr}$	Reverse recovery time	$I_F = 60\text{ A}$ , $V_R = 400\text{ V}$ , $V_{GE} = 15\text{ V}$ , $di_F/dt = 1000\text{ A}/\mu\text{s}$ $T_J = 175\text{ }^\circ\text{C}$ , see <a href="#">Figure 28</a>	-	131	-	ns
$Q_{rr}$	Reverse recovery charge		-	2816	-	nC
$I_{rrm}$	Reverse recovery current		-	43	-	A
$dl_{rr}/dt$	Peak rate of fall of reverse recovery current during $t_b$		-	404	-	A/ $\mu$ s
$E_{rr}$	Reverse recovery energy		-	821	-	$\mu$ J

## 2.1 Electrical characteristics (curves)

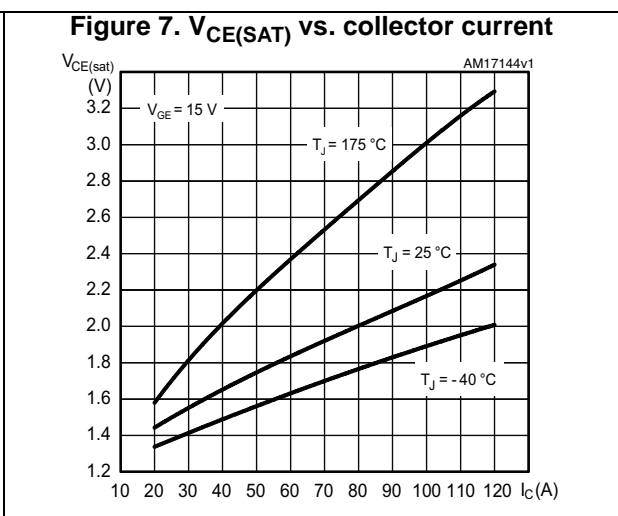
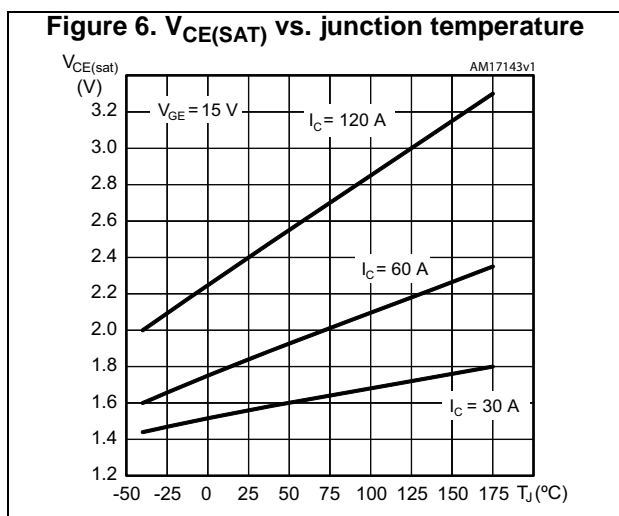
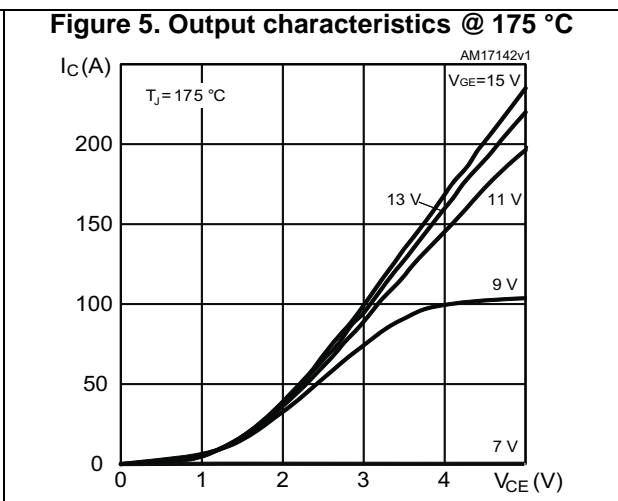
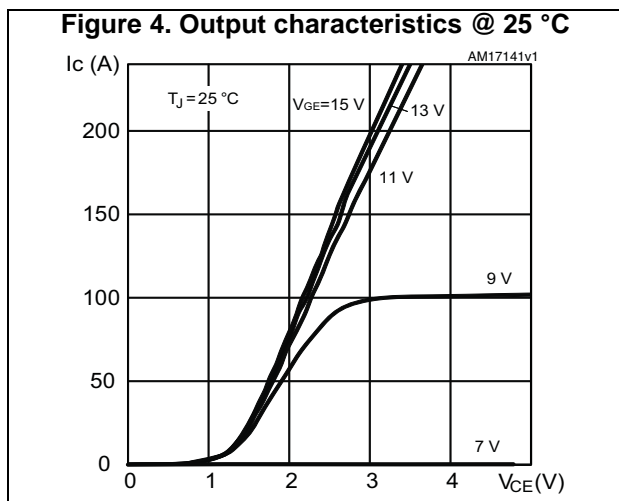
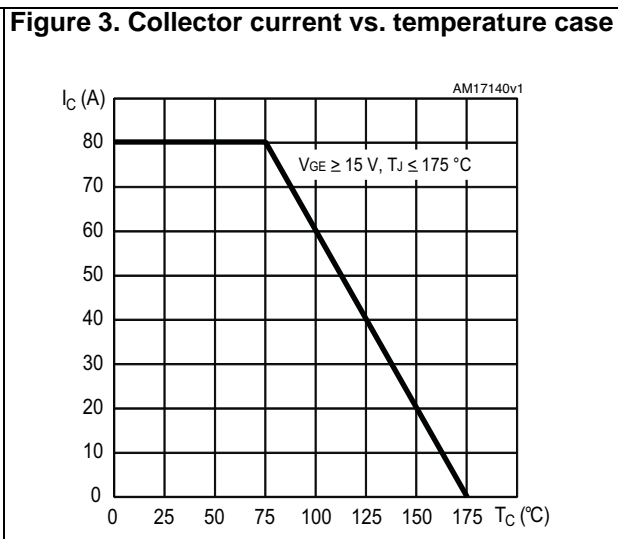
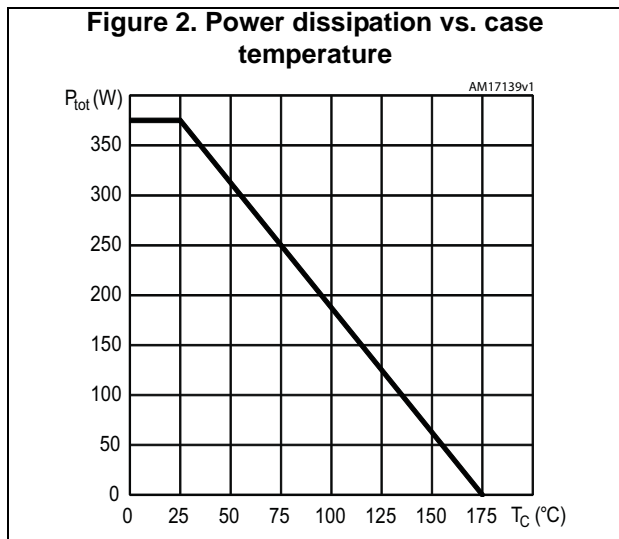

**Figure 8. Collector current vs. switching frequency**

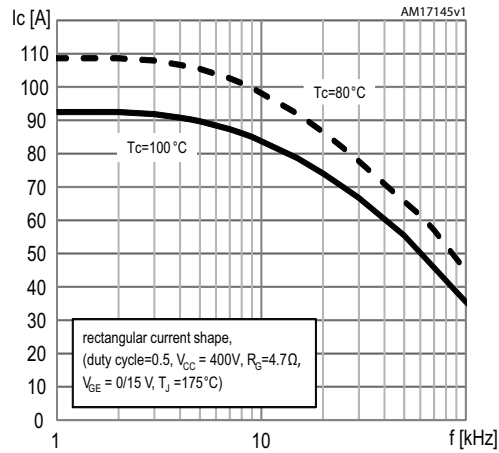

**Figure 9. Safe operating area**

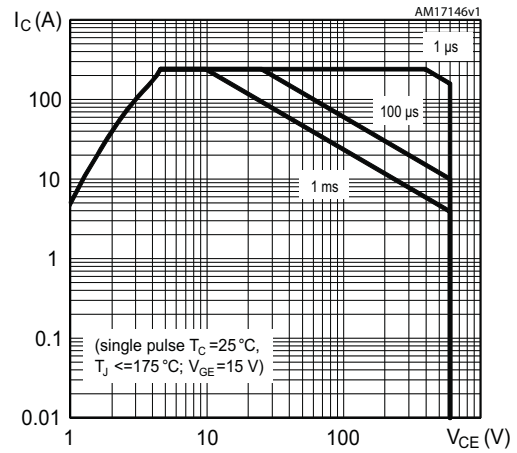

**Figure 10. Transfer characteristics**

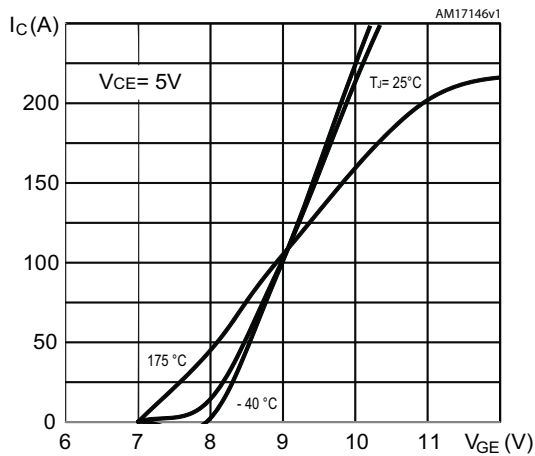

**Figure 11. Diode VF vs. forward current**

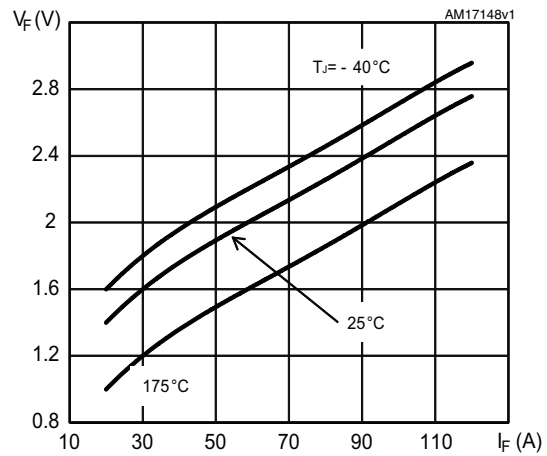

**Figure 12. Normalized VGE(th) vs. junction temperature**

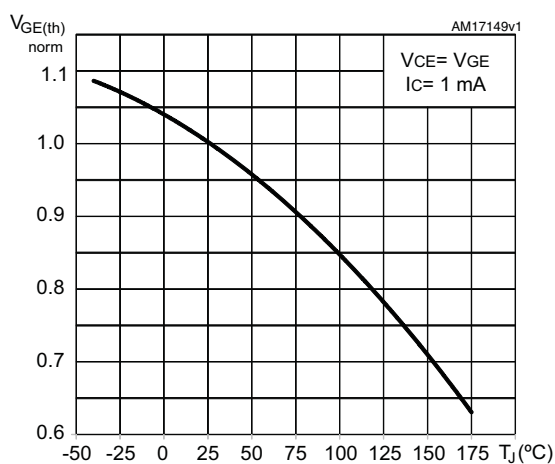

**Figure 13. Normalized V(BR)CES vs. junction temperature**

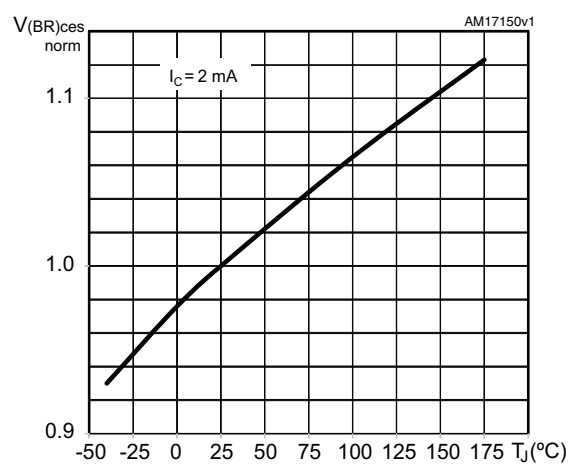

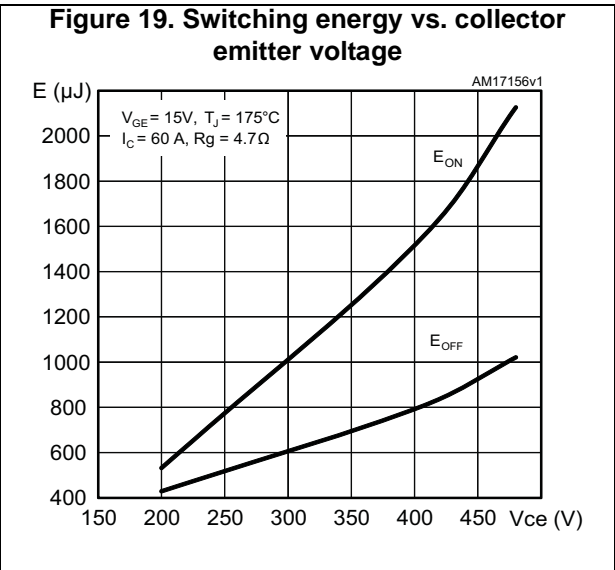
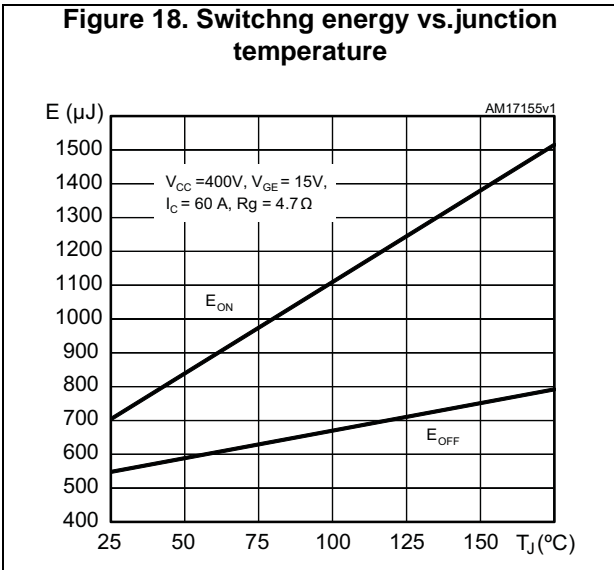
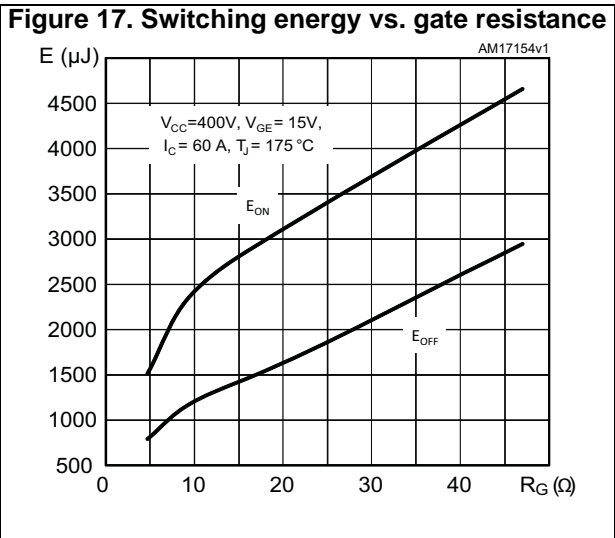
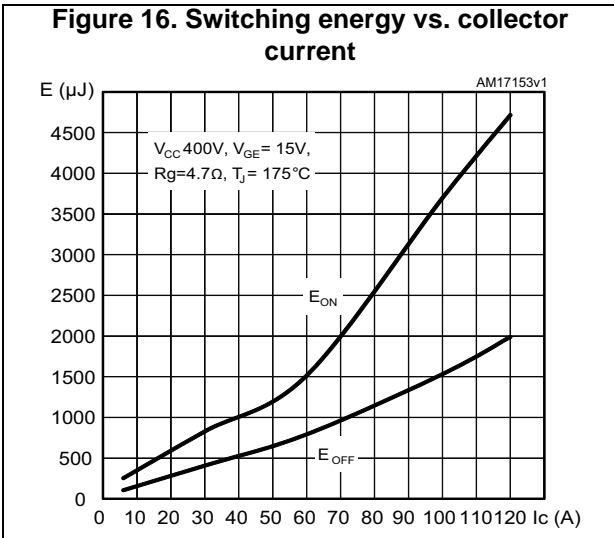
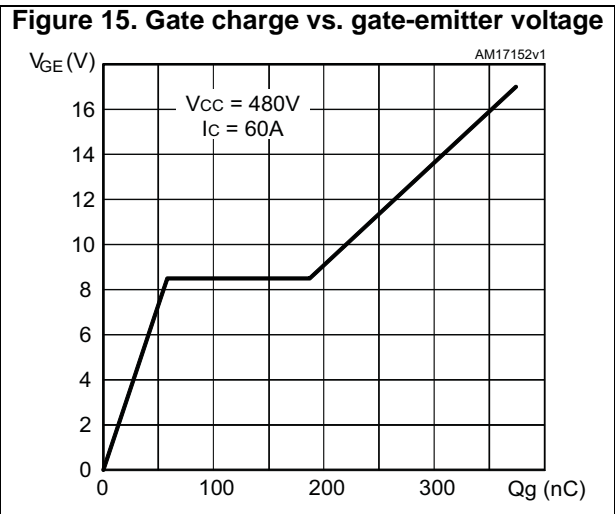
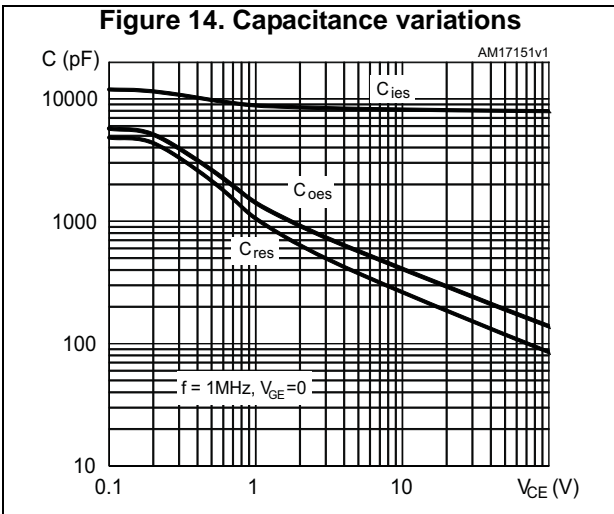



Figure 20. Switching times vs. collector current

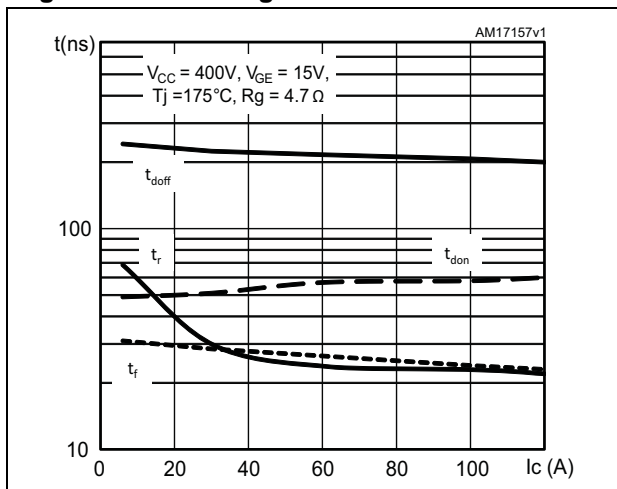

Figure 21. Switching times vs. gate resistance

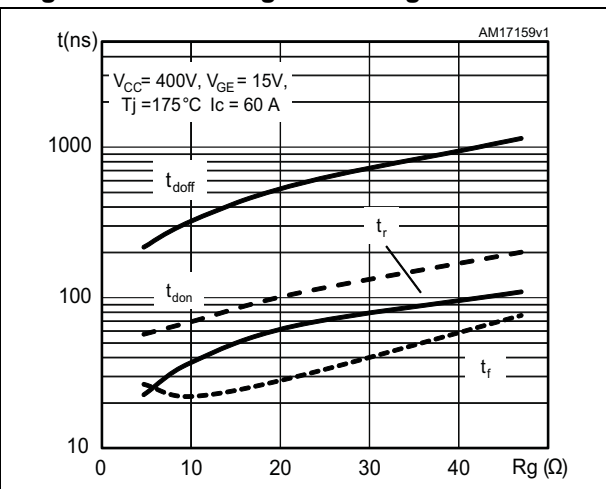

Figure 22. Reverse recovery current vs. diode current slope

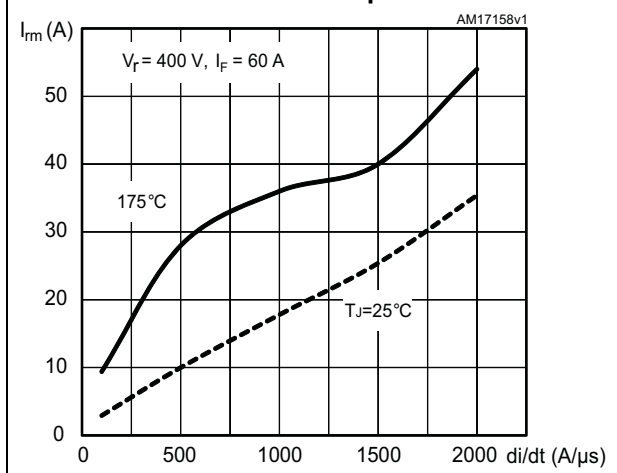

Figure 23. Reverse recovery time vs. diode current slope

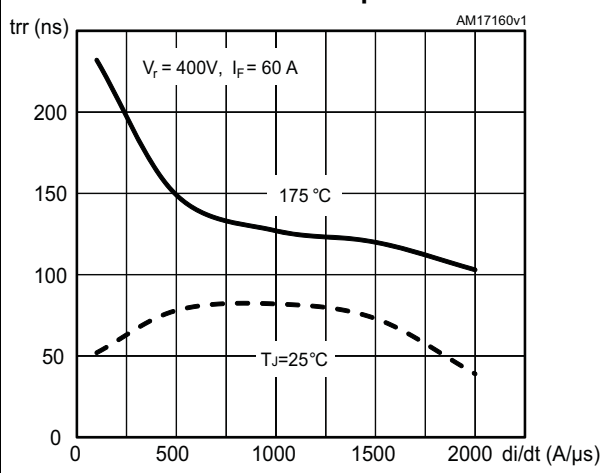

Figure 24. Reverse recovery charge vs. diode current slope

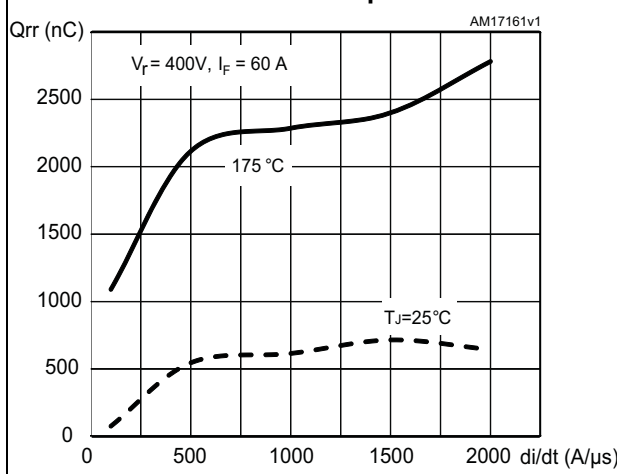

Figure 25. Reverse recovery energy vs. diode current slope

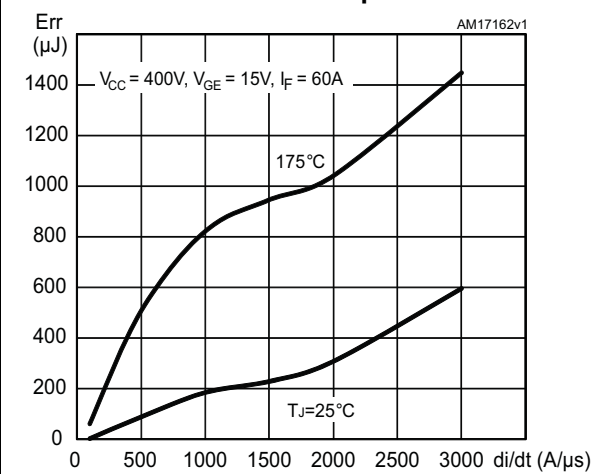

Figure 26. Thermal data for IGBT

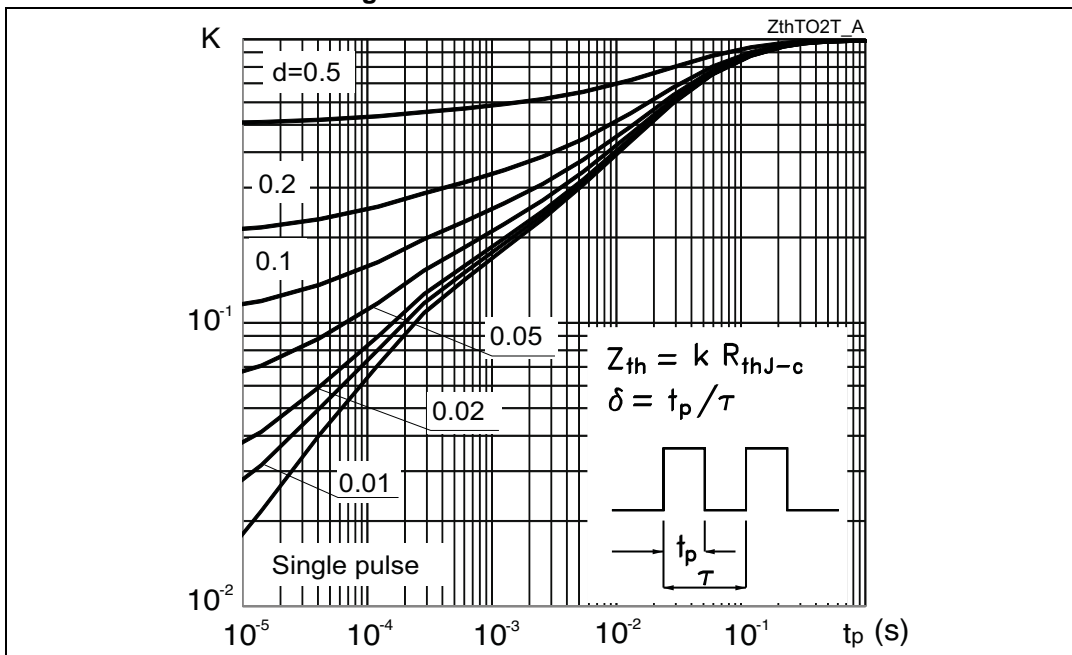
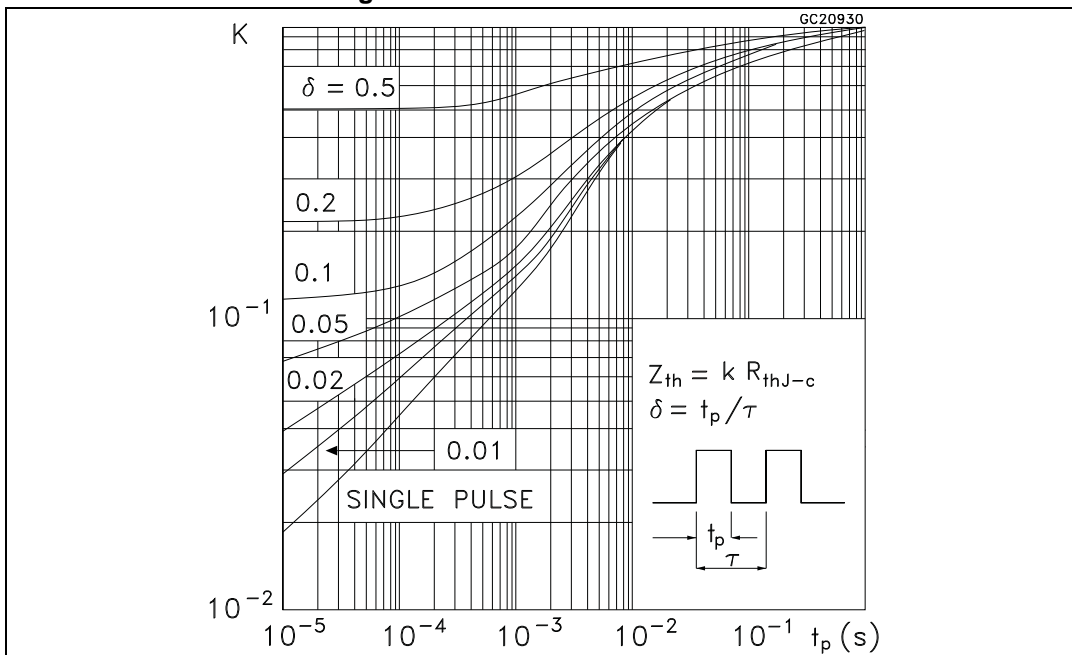
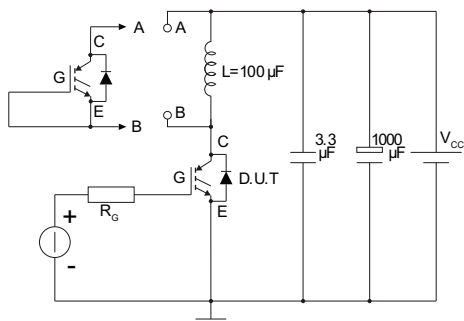

Figure 27. Thermal data for diode



### 3 Test circuits

**Figure 28. Test circuit for inductive load switching**



AM01504v1

**Figure 29. Gate charge test circuit**

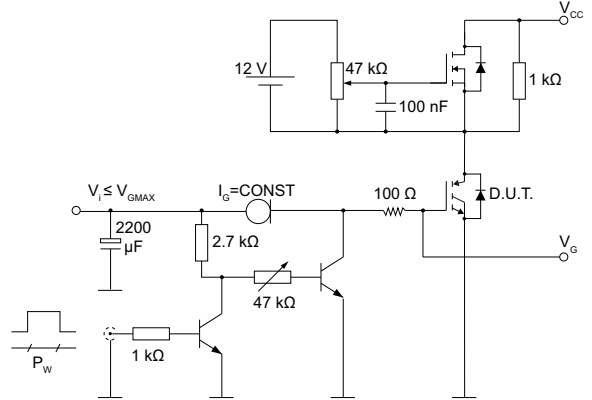

AM01505v1

**Figure 30. Switching waveform**

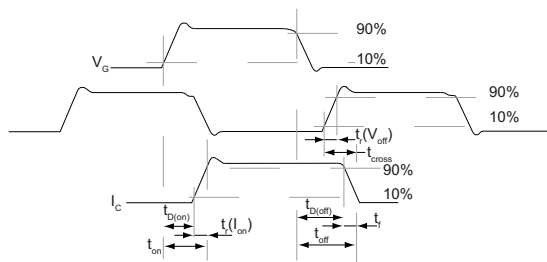

AM01506v1

**Figure 31. Diode recovery time waveform**

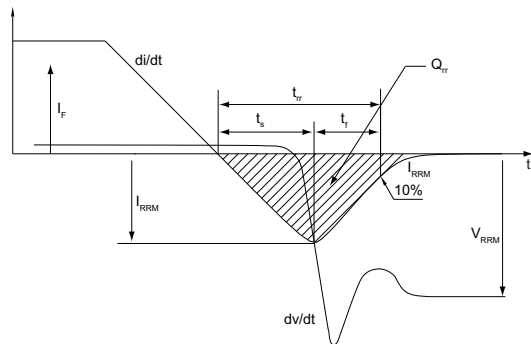

AM01507v1

## 4 Package information

In order to meet environmental requirements, ST offers these devices in different grades of ECOPACK<sup>®</sup> packages, depending on their level of environmental compliance. ECOPACK<sup>®</sup> specifications, grade definitions and product status are available at: [www.st.com](http://www.st.com). ECOPACK is an ST trademark.

### 4.1 TO-247 package information

Figure 32. TO-247 package outline

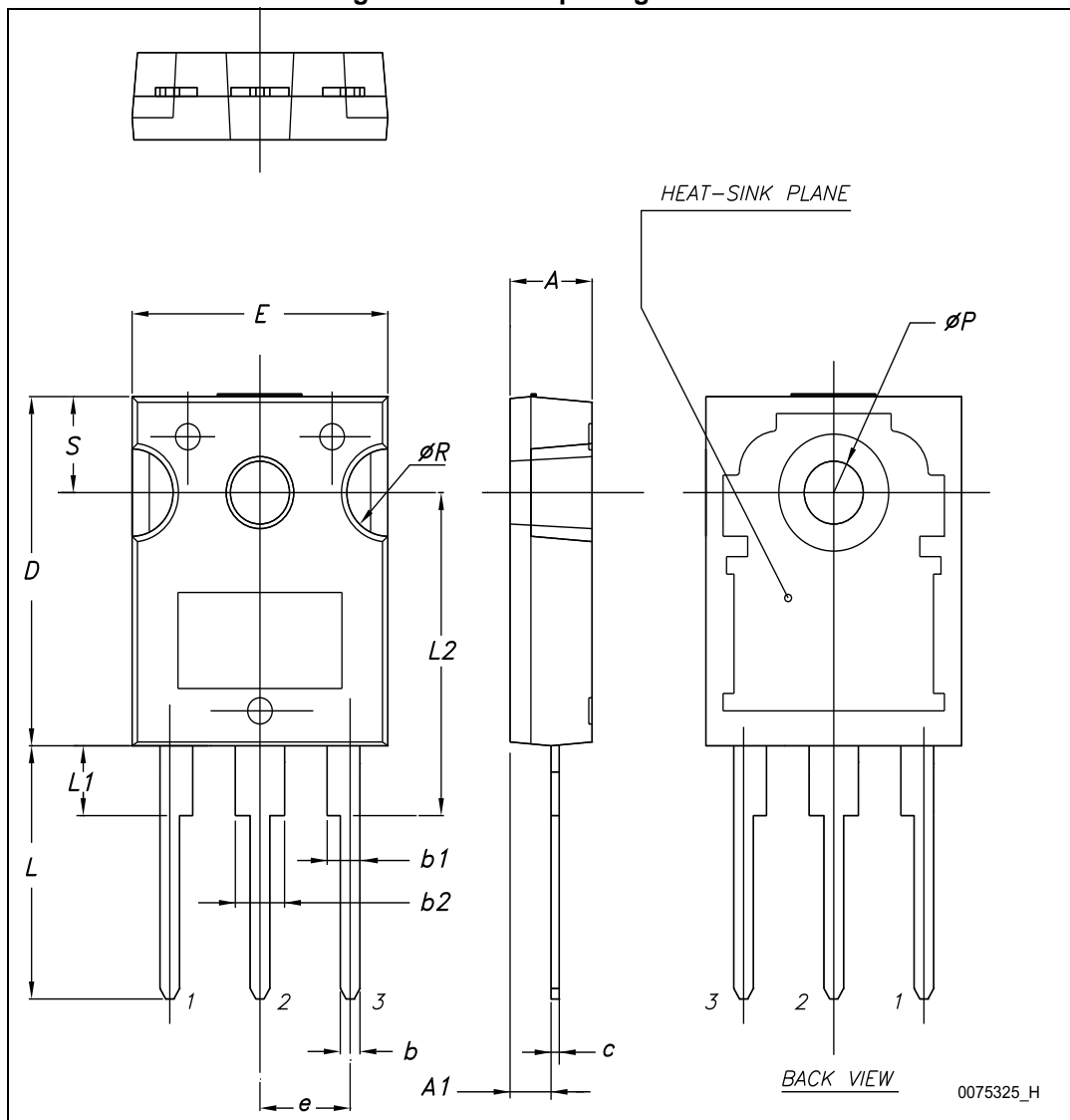

Table 8. TO-247 package mechanical data

Dim.	mm.		
	Min.	Typ.	Max.
A	4.85		5.15
A1	2.20		2.60
b	1.0		1.40
b1	2.0		2.40
b2	3.0		3.40
c	0.40		0.80
D	19.85		20.15
E	15.45		15.75
e	5.30	5.45	5.60
L	14.20		14.80
L1	3.70		4.30
L2		18.50	
ØP	3.55		3.65
ØR	4.50		5.50
S	5.30	5.50	5.70

### 4.2 TO-247 long leads package information

Figure 33. TO-247 long leads package outline

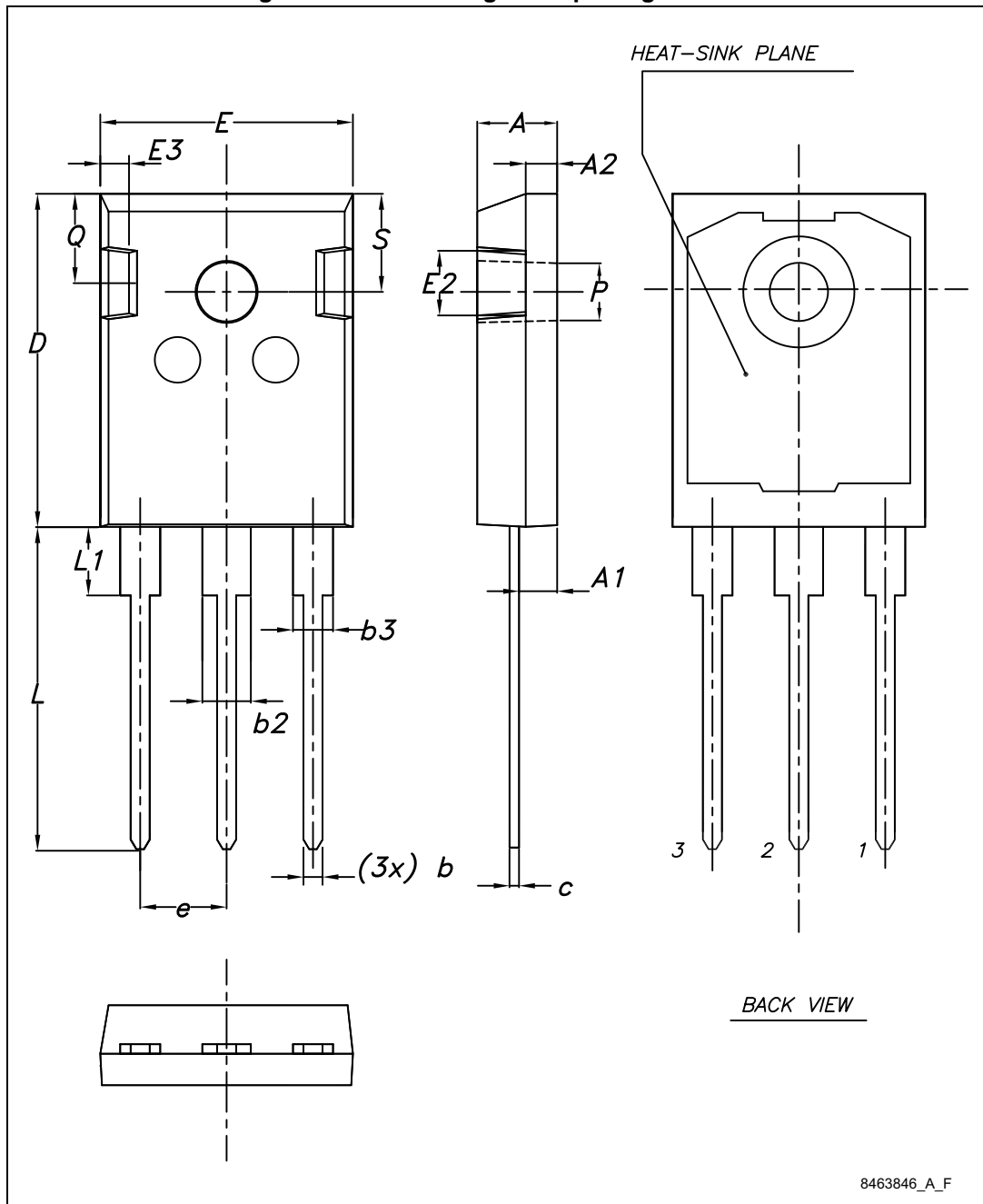

Table 9. TO-247 long leads package mechanical data

Dim.	mm		
	Min.	Typ.	Max.
A	4.90	5.00	5.10
A1	2.31	2.41	2.51
A2	1.90	2.00	2.10
b	1.16		1.26
b2			3.25
b3			2.25
c	0.59		0.66
D	20.90	21.00	21.10
E	15.70	15.80	15.90
E2	4.90	5.00	5.10
E3	2.40	2.50	2.60
e	5.34	5.44	5.54
L	19.80	19.92	20.10
L1			4.30
P	3.50	3.60	3.70
Q	5.60		6.00
S	6.05	6.15	6.25



### 4.3 TO-3P package information

Figure 34. TO-3P package outline

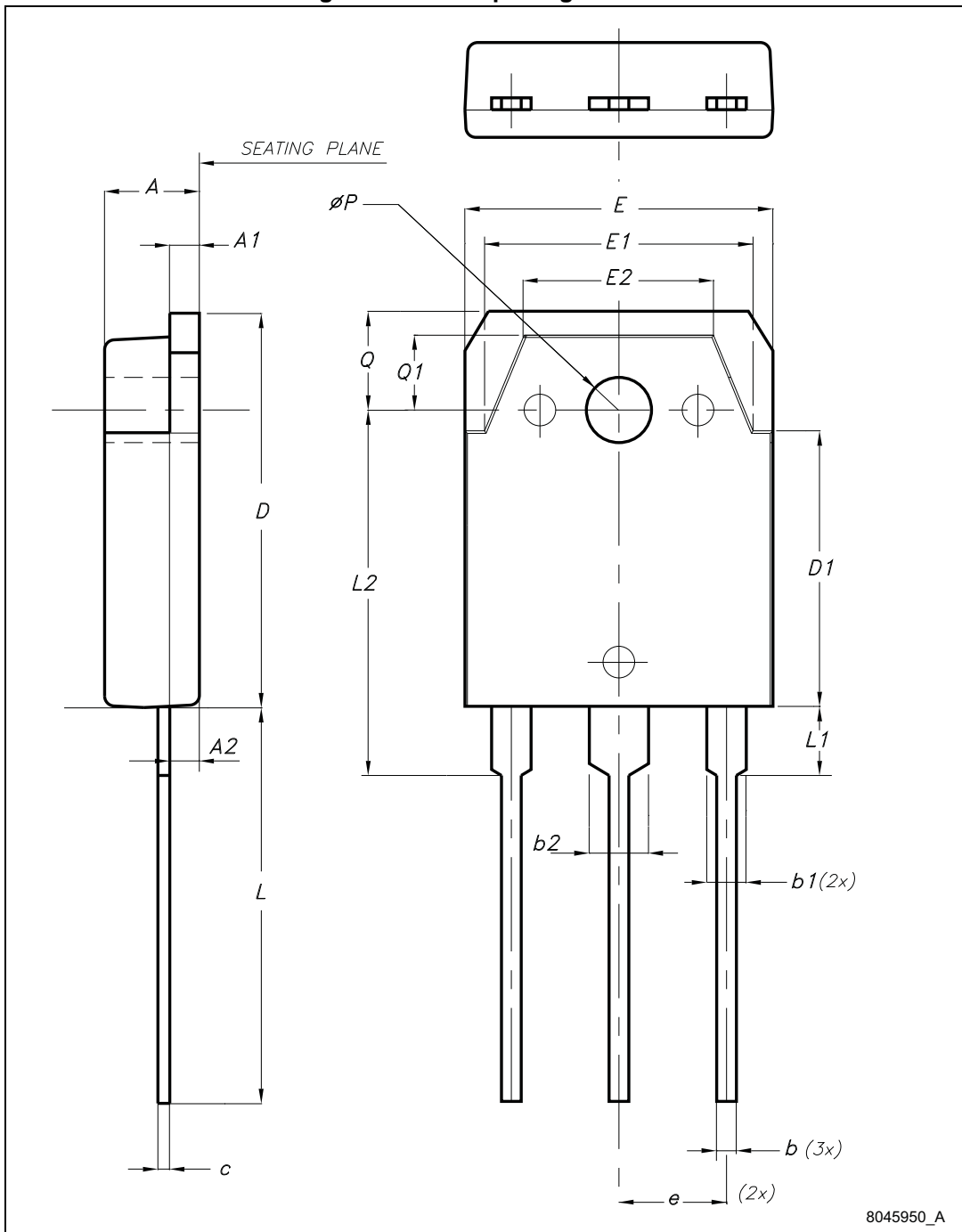

Table 10. TO-3P mechanical data

Dim.	mm		
	Min.	Typ.	Max.
A	4.60		5
A1	1.45	1.50	1.65
A2	1.20	1.40	1.60
b	0.80	1	1.20
b1	1.80		2.20
b2	2.80		3.20
c	0.55	0.60	0.75
D	19.70	19.90	20.10
D1		13.90	
E	15.40		15.80
E1		13.60	
E2		9.60	
e	5.15	5.45	5.75
L	19.50	20	20.50
L1		3.50	
L2	18.20	18.40	18.60
øP	3.10		3.30
Q		5	
Q1		3.80	

## 5 Revision history

Table 11. Document revision history

Date	Revision	Changes
15-Jan-2013	1	Initial release.
23-Apr-2013	2	Added: <ul style="list-style-type: none"> <li>– New order code STGWT60V60DF and new package mechanical data TO-3P <i>Table 9 on page 16, Figure 33 on page 15.</i></li> <li>– <i>Section 2.1: Electrical characteristics (curves) on page 6.</i></li> </ul>
04-Jun-2013	3	Updated <i>Table 4: Static characteristics</i> and <i>Figure 12 on page 7.</i> Document status changed from preliminary to production data.
21-Jun-2013	4	Updated <i>Figure 3: Collector current vs. temperature case.</i>
12-Jul-2013	5	Updated $R_{thJC}$ value for Diode in <i>Table 3: Thermal data.</i>
21-Oct-2013	6	Updated title, features and description in cover page.
28-Sep-2016	7	Added part number STGWA60V60DF and <i>TO-247 long leads package information.</i> Updated <i>Table 2 Table 4</i> and <i>Table 6.</i> Updated <i>Figure 10: Transfer characteristics.</i> Minor text changes.

**IMPORTANT NOTICE – PLEASE READ CAREFULLY**

STMicroelectronics NV and its subsidiaries ("ST") reserve the right to make changes, corrections, enhancements, modifications, and improvements to ST products and/or to this document at any time without notice. Purchasers should obtain the latest relevant information on ST products before placing orders. ST products are sold pursuant to ST's terms and conditions of sale in place at the time of order acknowledgement.

Purchasers are solely responsible for the choice, selection, and use of ST products and ST assumes no liability for application assistance or the design of Purchasers' products.

No license, express or implied, to any intellectual property right is granted by ST herein.

Resale of ST products with provisions different from the information set forth herein shall void any warranty granted by ST for such product.

ST and the ST logo are trademarks of ST. All other product or service names are the property of their respective owners.

Information in this document supersedes and replaces information previously supplied in any prior versions of this document.

© 2016 STMicroelectronics – All rights reserved