

# Force-Guided Relays G7SA



Rev. 9.09

## Compact, Slim Relays Conforming to EN Standards

- Relays with forcibly guided contacts (EN50205 Class A, certified by VDE)
- Supports the CE marking of machinery (Machinery Directive)
- Helps avoid hazardous machine status when used as part of an interlocking circuit
- Four-pole and six-pole Relays are available
- The relay's terminal arrangement simplifies PWB pattern design
- Reinforced insulation between inputs and outputs. Reinforced insulation between some poles of different polarity.



## Specifications

### Ratings

#### Coil

Rated Voltage	Rated Current (mA)	Coil Resistance (Ω)	Must Operate Voltage (V)	Must Release Voltage (V)	Max. Voltage (V)	Power Consumption (mW)
24 VDC	4 poles: 15 6 poles: 20.8	4 poles: 1,600 6 poles: 1,152	75% max.	10% min.	110%	4 poles: Approx. 360 6 poles: Approx. 500

#### Notes:

1. The rated current and coil resistance are measured at a coil temperature of 23°C with tolerances of ±15%.
2. Performance characteristics are based on a coil temperature of 23°C.
3. The maximum voltage is based on an ambient operating temperature of 23°C maximum.

#### Contacts

	Resistive Load
Rated load	6 A at 250 VAC, 6 A at 30 VDC
Rated carry current	6 A
Max. switching voltage	250 VAC, 125 VDC
Max. switching current	6 A

### Certified Standards

- EN Standards, VDE Certified  
EN61810-1 (Electromechanical non-specified time all-or-nothing relays)  
EN50205 (Relays with forcibly guided (linked) contacts)
- UL standard UL508 Industrial Control Devices
- CSA standard CSA C22.2 No. 14 Industrial Control Devices

### Forcibly-Guided Contacts (from EN50205)

If an NO contact becomes welded, all NC contacts will maintain a minimum distance of 0.5 mm when the coil is not energized. Likewise if an NC contact becomes welded, all NO contacts will maintain a minimum distance of 0.5 mm when the coil is energized.

### Characteristics of Sockets

Model	Continuous Current	Dielectric Strength	Insulation Resistance
P7SA-1□	6 A *1	2,500 VAC for 1 min. between poles	1,000 MΩ min. *2

#### Notes:

Use the P7SA-1□F-ND in the ambient temperature range of -20 to 70°C.

Use the P7SA-1□F and P7SA-1□F-ND in the ambient humidity range of 45 to 85%.

\*1. When operating the P7SA-1□F at a temperature between 55 and 85°C, reduce the continuous current (6 A at 55°C or less) by 0.1 A for each degree above 55°C.

When operating the P7SA-1□F-ND at a temperature between 50 and 70°C, reduce the continuous current (6 A at 50°C or less) by 0.3 A for each degree above 50°C.

\*2. Measurement conditions: Measurement of the same points as for the dielectric strength at 500 VDC.

## Engineering Data

### Durability Curve

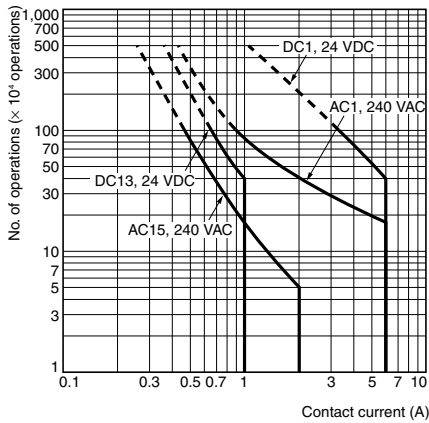

### Dimensions

(mm)

#### G7SA-3A1B G7SA-2A2B

H

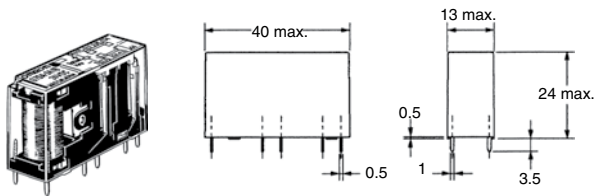

#### Terminal Arrangement/ Internal Connection Diagram (Bottom View)

##### G7SA-3A1B

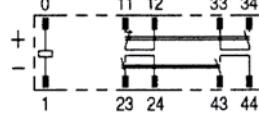

#### Printed Circuit Board Design Diagram (Bottom View)

(±0.1 tolerance)

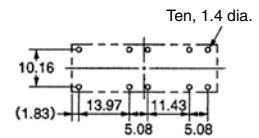

#### Notes:

- Terminals 23-24, 33-34, and 43-44 are normally open. Terminals 11-12 and 21-22 are normally closed.
- The colors of the cards inside the Relays are as follows: G7SA-3A1B: Blue and G7SA-2A2B: White.

#### G7SA-5A1B G7SA-4A2B G7SA-3A3B

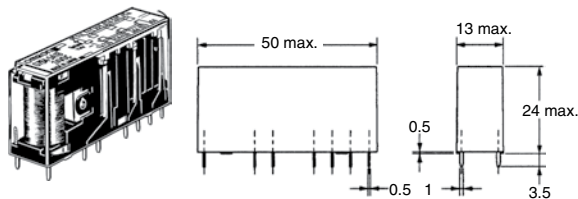

#### Terminal Arrangement/ Internal Connection Diagram (Bottom View)

##### G7SA-5A1B

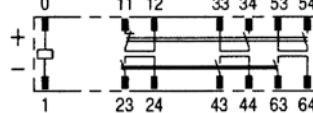

#### Printed Circuit Board Design Diagram (Bottom View)

(±0.1 tolerance)

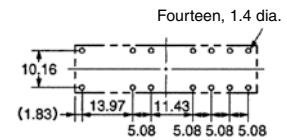

#### Notes:

- Terminals 23-24, 33-34, 43-44, 53-54, and 63-64 are normally open. Terminals 11-12, 21-22, and 31-32 are normally closed.
- The colors of the cards inside the Relays are as follows: G7SA-5A1B: Blue, G7SA-4A2B: White, and G7SA-3A3B: Yellow.

##### G7SA-4A2B

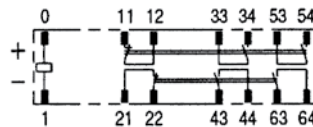

##### G7SA-3A3B



Dimensions (continued)

(mm)

Track-mounting Socket  
P7SA-10F, P7SA-10F-ND

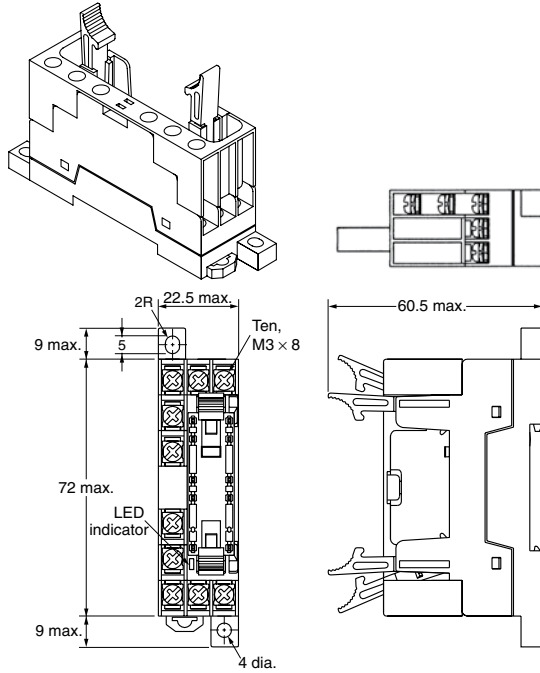

Note 1: The socket is shown with the finger cover removed.  
2: Only the -ND Sockets have LED indicators (orange)

Terminal Arrangement/Internal Connection Diagram  
(Top View)

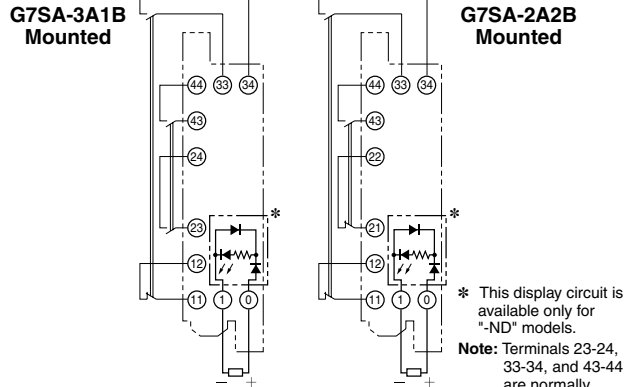

\* This display circuit is available only for "-ND" models.  
Note: Terminals 23-24, 33-34, and 43-44 are normally open. Terminals 11-12 and 21-22 are normally closed.

Mounting Hole Placement Diagram  
(Top View)

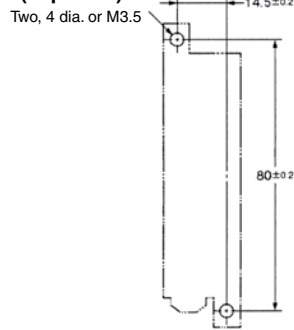

H

Track-mounting Socket  
P7SA-14F, P7SA-14F-ND

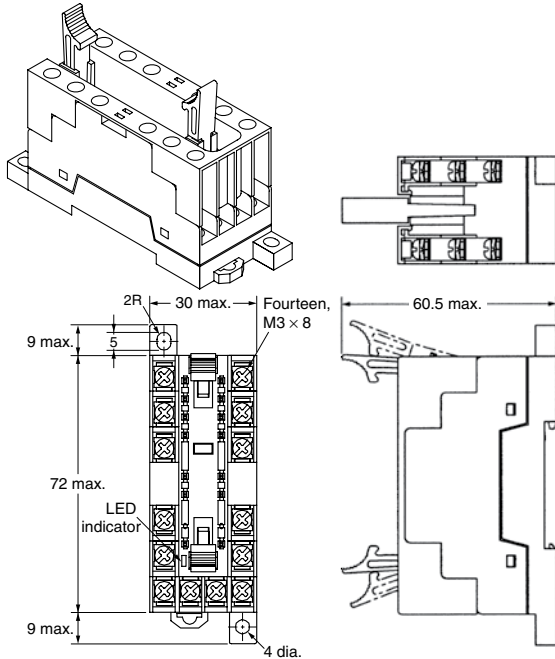

Note 1: The socket is shown with the finger cover removed.  
2: Only the -ND Sockets have LED indicators (orange).

Terminal Arrangement/Internal Connection Diagram  
(Top View)

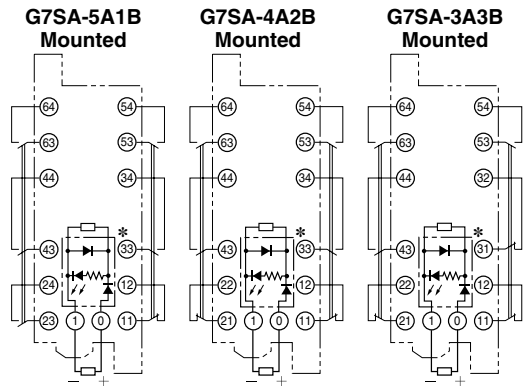

\* This display circuit is available only for "-ND" models.  
Note: Terminals 23-24, 33-34, 43-44, 53-54, and 63-64 are normally open. Terminals 11-12, 21-22, and 31-32 are normally closed.

Mounting Hole Placement Diagram  
(Top View)

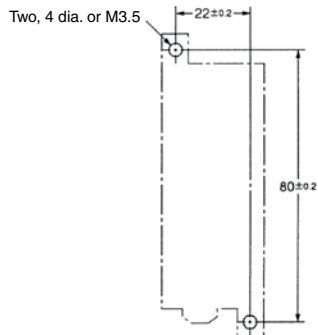

Dimensions (continued)

(mm)

Back-mounting Socket (for PCB)  
P7SA-10P

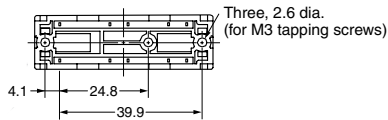
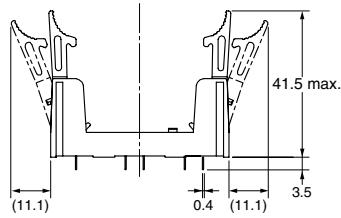
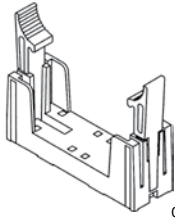

Terminal Arrangement/Internal Connection Diagram (Bottom View)

Mounting Hole Placement (Bottom View) ( $\pm 0.1$  tolerance)

G7SA-3A1B Mounted

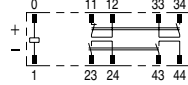

G7SA-2A2B Mounted

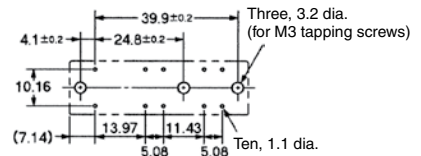
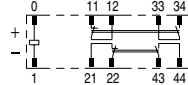

Note: Terminals 23-24, 33-34, and 43-44 are normally open. Terminals 11-12 and 21-22 are normally closed.

H

Back-mounting Socket (for PCB)  
P7SA-14P

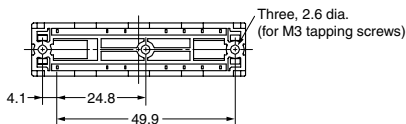
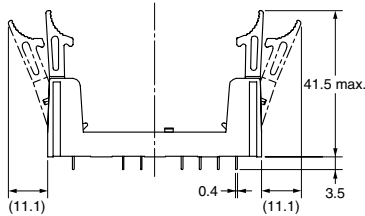
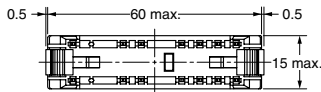
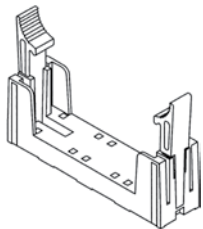

Terminal Arrangement/Internal Connection Diagram (Bottom View)

Mounting Hole Placement (Bottom View) ( $\pm 0.1$  tolerance)

G7SA-5A1B Mounted

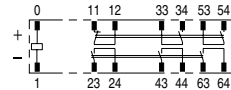

G7SA-4A2B Mounted

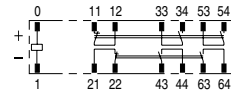

G7SA-3A3B Mounted

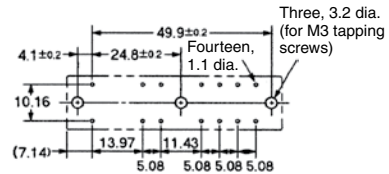

Note: Terminals 23-24, 33-34, 43-44, 53-54, and 63-64 are normally open. Terminals 11-12, 21-22, and 31-32 are normally closed.

## Ordering

### Model Number Legend

G7SA - □ A □ B

① ②

- ① NO Contact Poles  
 2: DPST-NO  
 3: 3PST-NO  
 4: 4PST-NO  
 5: 5PST-NO
- ② NC Contact Poles  
 1: SPST-NC  
 2: DPST-NC  
 3: 3PST-NC

### Relays with Forcibly Guided Contacts

Type	Sealing	Poles	Contact Configuration	Rated Voltage*	Model
Standard	Flux-tight	4 poles	3PST-NO, SPST-NC	24 VDC	G7SA-3A1B
			DPST-NO, DPST-NC		G7SA-2A2B
		6 poles	5PST-NO, SPST-NC		G7SA-5A1B
			4PST-NO, DPST-NC		G7SA-4A2B
			3PST-NO, 3PST-NC		G7SA-3A3B

\*Consult your Omron STI representative for details on rated voltages of 12 VDC, 18 VDC, 21 VDC and 48 VDC.

H

### Sockets

Type	LED Indicator	Poles	Rated Voltage	Model
Track-mounting	No	4 poles	---	P7SA-10F
		6 poles		P7SA-14F
	Yes	4 poles	24 VDC	P7SA-10F-ND
		6 poles		P7SA-14F-ND
Back-mounting	No	4 poles	---	P7SA-10P
		6 poles		P7SA-14P

### Relays with Forcibly Guided Contacts and Track Mounting Sockets (assemblies)

Relay Specifications			Socket Specifications			
Poles	Contact Configuration	Rated Coil Voltage	Type	LED Indicator	LED Rated Voltage	Assembly Model
4 poles	DPST-NO, DPST-NC	24 VDC	Track Mounting and screw mounting possible	No		FGRMS22-24
4 poles	3PST-NO, SPST-NC	24 VDC	Track Mounting and screw mounting possible	No		FGRM-S31-24
6 poles	3PST-NO, 3PST-NC	24 VDC	Track Mounting and screw mounting possible	No		FGRM-S33-24
6 poles	4PST-NO, 2PST-NC	24 VDC	Track Mounting and screw mounting possible	No		FGRM-S42-24
6 poles	5PST-NO, SPST-NC	24 VDC	Track Mounting and screw mounting possible	No		FGRM-S51-24
4 poles	DPST-NO, DPST-NC	24 VDC	Track Mounting and screw mounting possible	Yes	24 VDC	FGRMS22-24-LED
4 poles	3PST-NO, SPST-NC	24 VDC	Track Mounting and screw mounting possible	Yes	24 VDC	FGRM-S31-24-LED
6 poles	3PST-NO, 3PST-NC	24 VDC	Track Mounting and screw mounting possible	Yes	24 VDC	FGRM-S33-24-LED
6 poles	4PST-NO, 2PST-NC	24 VDC	Track Mounting and screw mounting possible	Yes	24 VDC	FGRM-S42-24-LED
6 poles	5PST-NO, SPST-NC	24 VDC	Track Mounting and screw mounting possible	Yes	24 VDC	FGRM-S51-24-LED

 = Highlighted **Rapid Delivery** products are available for shipment today or within **FIVE** days.