

DRQ

Dual winding, high power density, shielded drum core power inductors



Product features

- Dual winding inductors that can be used as either a single inductor, or in coupled inductor/transformer applications (1:1 turns ratio)
- Four sizes of shielded drum core inductors
- Windings can be connected in series or parallel, offering a broad range of inductance and current ratings
- Peak current ratings from 0.13 A to 56 A
- RMS current ratings from 0.128 A to 17.9 A
- Inductance ratings from 0.33 μ H to 4.02 mH
- 200 Vac Isolation between windings
- Ferrite core material

Applications

- Desktop and servers
- DVD and media players
- Portable and handheld devices
- LCD panels
- As a transformer: SEPIC, flyback
- As an inductor: buck, boost, coupled inductor
- DC-DC Converters
- VRM inductor for CPU and DDR power supplies
- Input and output filter chokes

Environmental data

- Storage temperature range (component): -40 °C to +125 °C
- Operating temperature range: -40 °C to +125 °C (ambient plus self-temperature rise)
- Solder reflow temperature: J-STD-020 (latest revision) compliant



Product specifications

| Part Number | Rated Inductance (μH) | Parallel Ratings | | | | | Series Ratings | | | | |
|-------------|-----------------------|----------------------------|-----------------------------------|--|-------------------------|-------------------------|----------------------------|-----------------------------------|--|-------------------------|-------------------------|
| | | OCL ¹ ±20% (μH) | I _{rms} ² (A) | I _{sat} ³ (A) Peak | DCR Ω ⁴ typ. | Volt ⁵ μ-sec | OCL ¹ ±20% (μH) | I _{rms} ² (A) | I _{sat} ³ (A) Peak | DCR Ω ⁴ typ. | Volt ⁵ μ-sec |
| DRQ73-R33-R | 0.33 | 0.306 | 6.19 | 14.4 | 0.0074 | 1.98 | 1.224 | 3.10 | 7.18 | 0.0296 | 3.96 |
| DRQ73-1R0-R | 1.00 | 0.992 | 5.25 | 7.97 | 0.0103 | 3.56 | 3.968 | 2.63 | 3.99 | 0.0411 | 7.12 |
| DRQ73-1R5-R | 1.50 | 1.482 | 4.64 | 6.52 | 0.0132 | 4.36 | 5.928 | 2.32 | 3.26 | 0.0527 | 8.72 |
| DRQ73-2R2-R | 2.20 | 2.070 | 4.11 | 5.52 | 0.0167 | 5.15 | 8.280 | 2.06 | 2.76 | 0.0669 | 10.3 |
| DRQ73-3R3-R | 3.30 | 3.540 | 3.31 | 4.22 | 0.0259 | 6.73 | 14.16 | 1.66 | 2.11 | 0.1035 | 13.5 |
| DRQ73-4R7-R | 4.70 | 4.422 | 3.09 | 3.78 | 0.0297 | 7.52 | 17.69 | 1.55 | 1.89 | 0.1188 | 15.0 |
| DRQ73-6R8-R | 6.80 | 6.480 | 2.55 | 3.12 | 0.0435 | 9.11 | 25.92 | 1.28 | 1.56 | 0.1742 | 18.2 |
| DRQ73-8R2-R | 8.20 | 8.930 | 2.19 | 2.66 | 0.0592 | 10.7 | 35.72 | 1.10 | 1.33 | 0.2368 | 21.4 |
| DRQ73-100-R | 10.0 | 10.30 | 2.08 | 2.47 | 0.0656 | 11.5 | 41.20 | 1.04 | 1.24 | 0.2623 | 23.0 |
| DRQ73-150-R | 15.0 | 15.01 | 1.83 | 2.05 | 0.0844 | 13.9 | 60.04 | 0.916 | 1.03 | 0.339 | 27.8 |
| DRQ73-220-R | 22.0 | 22.65 | 1.62 | 1.67 | 0.107 | 17.0 | 90.60 | 0.811 | 0.83 | 0.429 | 34.0 |
| DRQ73-330-R | 33.0 | 34.41 | 1.31 | 1.35 | 0.166 | 21.0 | 137.6 | 0.653 | 0.68 | 0.665 | 42.0 |
| DRQ73-470-R | 47.0 | 48.62 | 1.08 | 1.14 | 0.241 | 24.9 | 194.5 | 0.542 | 0.57 | 0.965 | 49.8 |
| DRQ73-680-R | 68.0 | 68.91 | 0.89 | 0.96 | 0.358 | 29.7 | 275.6 | 0.444 | 0.48 | 1.43 | 59.4 |
| DRQ73-820-R | 82.0 | 80.37 | 0.86 | 0.89 | 0.384 | 32.1 | 321.5 | 0.430 | 0.44 | 1.54 | 64.2 |
| DRQ73-101-R | 100 | 101.4 | 0.73 | 0.79 | 0.527 | 36.0 | 405.6 | 0.367 | 0.39 | 2.11 | 72.0 |
| DRQ73-151-R | 150 | 150.9 | 0.58 | 0.65 | 0.851 | 44.0 | 603.6 | 0.289 | 0.32 | 3.41 | 88.0 |
| DRQ73-221-R | 220 | 223.3 | 0.52 | 0.53 | 1.05 | 53.5 | 893.2 | 0.260 | 0.27 | 4.20 | 107 |
| DRQ73-331-R | 330 | 325.5 | 0.42 | 0.44 | 1.59 | 64.5 | 1302 | 0.211 | 0.22 | 6.36 | 129 |
| DRQ73-471-R | 470 | 465.8 | 0.35 | 0.37 | 2.36 | 77.2 | 1863 | 0.173 | 0.18 | 9.44 | 154 |
| DRQ73-681-R | 680 | 676.5 | 0.29 | 0.31 | 3.47 | 93.1 | 2706 | 0.143 | 0.15 | 13.88 | 186 |
| DRQ73-821-R | 820 | 821.7 | 0.27 | 0.28 | 3.93 | 103 | 3287 | 0.134 | 0.14 | 15.72 | 206 |
| DRQ73-102-R | 1000 | 995.0 | 0.26 | 0.25 | 4.34 | 113 | 3980 | 0.128 | 0.13 | 17.36 | 226 |

- Open Circuit Inductance Test Parameters: 100 kHz, 0.25 V_{rms}, 0.0 Adc
Parallel: (1,2 -4,3) Series: (1-4) tie (2-3)
- RMS current for an approximate DT of 40 °C without core loss.
It is recommended that the temperature of the part not exceed +125 °C.
- Peak current for approximately 30% roll-off at +20 °C
- DCR limits @ +20 °C
- Applied Volt-Time product (V-μs) across the inductor. This value represents the applied V-μs at 100 kHz necessary to generate a core loss equal to 10% of the total losses for a 40 °C temperature rise.

- Turns Ratio (1:3):(2-4) 1:1
- Part number definition: DRQxxx-yyy-
- DRQxxx = product code and size,
- yyy = inductance value in μH,
- R = decimal point. If no R is present, third character = # of zeros
- "-R" suffix = RoHS compliant

Product specifications

| Part Number | Rated Inductance (μH) | Parallel Ratings | | | | | Series Ratings | | | | |
|-------------|-----------------------|----------------------------|-----------------------------------|--|-------------------------|-------------------------|----------------------------|-----------------------------------|--|-------------------------|-------------------------|
| | | OCL ¹ ±20% (μH) | I _{rms} ² (A) | I _{sat} ³ (A) Peak | DCR Ω ⁴ Typ. | Volt ⁵ μ-sec | OCL ¹ ±20% (μH) | I _{rms} ² (A) | I _{sat} ³ (A) Peak | DCR Ω ⁴ Typ. | Volt ⁵ μ-sec |
| DRQ74-R33-R | 0.33 | 0.294 | 6.20 | 18.4 | 0.0074 | 1.71 | 1.176 | 3.10 | 9.18 | 0.0295 | 3.42 |
| DRQ74-1R0-R | 1.00 | 0.952 | 5.33 | 10.2 | 0.0100 | 3.08 | 3.808 | 2.66 | 5.10 | 0.0400 | 6.16 |
| DRQ74-1R5-R | 1.50 | 1.422 | 4.96 | 8.35 | 0.0115 | 3.76 | 5.688 | 2.48 | 4.17 | 0.0461 | 7.52 |
| DRQ74-2R2-R | 2.20 | 1.986 | 4.66 | 7.06 | 0.0130 | 4.45 | 7.944 | 2.33 | 3.53 | 0.0521 | 8.9 |
| DRQ74-3R3-R | 3.30 | 3.396 | 3.94 | 5.40 | 0.0183 | 5.81 | 13.58 | 1.97 | 2.70 | 0.0732 | 11.6 |
| DRQ74-4R7-R | 4.70 | 5.182 | 3.34 | 4.37 | 0.0254 | 7.18 | 20.73 | 1.67 | 2.19 | 0.102 | 14.4 |
| DRQ74-6R8-R | 6.80 | 7.344 | 2.60 | 3.67 | 0.0418 | 8.55 | 29.38 | 1.30 | 1.84 | 0.167 | 17.1 |
| DRQ74-8R2-R | 8.20 | 8.566 | 2.53 | 3.40 | 0.0441 | 9.23 | 34.26 | 1.27 | 1.70 | 0.177 | 18.5 |
| DRQ74-100-R | 10.0 | 9.882 | 2.41 | 3.17 | 0.0489 | 9.92 | 39.53 | 1.20 | 1.58 | 0.196 | 19.8 |
| DRQ74-150-R | 15.0 | 16.09 | 2.11 | 2.48 | 0.0637 | 12.7 | 64.36 | 1.05 | 1.24 | 0.255 | 25.4 |
| DRQ74-220-R | 22.0 | 21.73 | 1.75 | 2.13 | 0.0925 | 14.7 | 86.92 | 0.874 | 1.07 | 0.371 | 29.4 |
| DRQ74-330-R | 33.0 | 33.01 | 1.41 | 1.73 | 0.143 | 18.1 | 132.0 | 0.702 | 0.87 | 0.574 | 36.2 |
| DRQ74-470-R | 47.0 | 49.64 | 1.15 | 1.41 | 0.216 | 22.2 | 198.6 | 0.573 | 0.71 | 0.865 | 44.4 |
| DRQ74-680-R | 68.0 | 69.67 | 1.03 | 1.19 | 0.265 | 26.3 | 278.7 | 0.517 | 0.60 | 1.06 | 52.6 |
| DRQ74-820-R | 82.0 | 80.95 | 0.91 | 1.11 | 0.345 | 28.4 | 323.8 | 0.453 | 0.55 | 1.38 | 56.8 |
| DRQ74-101-R | 100 | 101.6 | 0.86 | 0.99 | 0.383 | 31.8 | 406.4 | 0.430 | 0.49 | 1.53 | 63.6 |
| DRQ74-151-R | 150 | 150.0 | 0.69 | 0.81 | 0.591 | 38.6 | 600.0 | 0.346 | 0.41 | 2.37 | 77.2 |
| DRQ74-221-R | 220 | 227.0 | 0.56 | 0.66 | 0.907 | 47.5 | 908.0 | 0.279 | 0.33 | 3.63 | 95 |
| DRQ74-331-R | 330 | 335.6 | 0.45 | 0.54 | 1.41 | 57.8 | 1342 | 0.224 | 0.27 | 5.66 | 116 |
| DRQ74-471-R | 470 | 465.3 | 0.40 | 0.46 | 1.74 | 68.1 | 1861 | 0.202 | 0.23 | 6.97 | 136 |
| DRQ74-681-R | 680 | 671.2 | 0.33 | 0.38 | 2.58 | 81.7 | 2685 | 0.166 | 0.19 | 10.3 | 163 |
| DRQ74-821-R | 820 | 812.7 | 0.31 | 0.35 | 2.93 | 89.9 | 3251 | 0.156 | 0.17 | 11.7 | 180 |
| DRQ74-102-R | 1000 | 1009 | 0.27 | 0.31 | 3.89 | 100 | 4036 | 0.135 | 0.16 | 15.6 | 200 |

1. Open Circuit Inductance Test Parameters: 100 kHz, 0.25 V_{rms}, 0.0 Adc
Parallel: (1,2 -4,3) Series: (1-4) tie (2-3)
2. RMS current for an approximate DT of 40 °C without core loss.
It is recommended that the temperature of the part not exceed +125 °C.
3. Peak current for approximately 30% roll-off at +20 °C
4. DCR limits @ +20 °C
5. Applied Volt-Time product (V-μs) across the inductor. This value represents the applied V-μs at 100 kHz necessary to generate a core loss equal to 10% of the total losses for a 40 °C temperature rise.

6. Turns Ratio (1:3):(2-4) 1:1
7. Part number definition: DRQxxx-yyy-
- DRQxxx = product code and size,
- yyy = inductance value in μH,
- R = decimal point. If no R is present, third character = # of zeros
- "-R" suffix = RoHS compliant

Product specifications

| Part Number | Rated Inductance (μH) | Parallel Ratings | | | | | Series Ratings | | | | |
|--------------|-----------------------|----------------------------|-----------------------------------|--|-------------------------|-------------------------|----------------------------|-----------------------------------|--|-------------------------|-------------------------|
| | | OCL ¹ ±20% (μH) | I _{rms} ² (A) | I _{sat} ³ (A) Peak | DCR Ω ⁴ typ. | Volt ⁵ μ-sec | OCL ¹ ±20% (μH) | I _{rms} ² (A) | I _{sat} ³ (A) Peak | DCR Ω ⁴ typ. | Volt ⁵ μ-sec |
| DRQ125-R47-R | 0.47 | 0.456 | 17.6 | 33.0 | 0.0018 | 3.17 | 1.824 | 8.80 | 16.5 | 0.0078 | 6.34 |
| DRQ125-1R0-R | 1.00 | 0.894 | 15.0 | 23.6 | 0.0024 | 4.43 | 3.576 | 7.51 | 11.8 | 0.0096 | 8.86 |
| DRQ125-1R5-R | 1.50 | 1.478 | 13.8 | 18.3 | 0.0029 | 5.70 | 5.912 | 6.89 | 9.15 | 0.0114 | 11.40 |
| DRQ125-2R2-R | 2.20 | 2.208 | 10.9 | 15.0 | 0.0045 | 6.97 | 8.832 | 5.46 | 7.50 | 0.0182 | 13.9 |
| DRQ125-3R3-R | 3.30 | 3.084 | 9.26 | 12.7 | 0.0063 | 8.23 | 12.34 | 4.63 | 6.35 | 0.0253 | 16.5 |
| DRQ125-4R7-R | 4.70 | 5.274 | 7.18 | 9.71 | 0.0105 | 10.8 | 21.10 | 3.59 | 4.86 | 0.0420 | 21.6 |
| DRQ125-6R8-R | 6.80 | 6.588 | 6.64 | 8.68 | 0.0123 | 12.0 | 26.35 | 3.32 | 4.34 | 0.0492 | 24.0 |
| DRQ125-8R2-R | 8.20 | 8.048 | 5.54 | 7.86 | 0.0176 | 13.3 | 32.19 | 2.77 | 3.93 | 0.0705 | 26.6 |
| DRQ125-100-R | 10.0 | 9.654 | 5.35 | 7.17 | 0.0189 | 14.6 | 38.62 | 2.67 | 3.59 | 0.0757 | 29.2 |
| DRQ125-150-R | 15.0 | 15.35 | 4.27 | 5.69 | 0.0298 | 18.4 | 61.40 | 2.13 | 2.85 | 0.120 | 36.8 |
| DRQ125-220-R | 22.0 | 22.36 | 3.70 | 4.71 | 0.0396 | 22.2 | 89.44 | 1.84 | 2.36 | 0.159 | 44.4 |
| DRQ125-330-R | 33.0 | 33.74 | 3.28 | 3.84 | 0.0505 | 27.2 | 135.0 | 1.64 | 1.92 | 0.203 | 54.4 |
| DRQ125-470-R | 47.0 | 47.47 | 2.71 | 3.24 | 0.0740 | 32.3 | 189.9 | 1.35 | 1.62 | 0.297 | 64.6 |
| DRQ125-680-R | 68.0 | 67.91 | 2.22 | 2.70 | 0.101 | 38.6 | 271.6 | 1.11 | 1.35 | 0.440 | 77.2 |
| DRQ125-820-R | 82.0 | 86.89 | 2.05 | 2.39 | 0.128 | 43.7 | 347.6 | 1.03 | 1.20 | 0.515 | 87.4 |
| DRQ125-101-R | 100 | 102.7 | 1.78 | 2.20 | 0.170 | 47.5 | 410.8 | 0.892 | 1.10 | 0.682 | 95.0 |
| DRQ125-151-R | 150 | 151.1 | 1.48 | 1.81 | 0.248 | 57.6 | 604.4 | 0.739 | 0.905 | 0.991 | 115.2 |
| DRQ125-221-R | 220 | 216.8 | 1.19 | 1.51 | 0.384 | 69.0 | 867.2 | 0.594 | 0.755 | 1.54 | 138 |
| DRQ125-331-R | 330 | 332.6 | 1.06 | 1.22 | 0.482 | 85.5 | 1330 | 0.530 | 0.610 | 1.93 | 171 |
| DRQ125-471-R | 470 | 473.1 | 0.87 | 1.02 | 0.718 | 102 | 1892 | 0.434 | 0.510 | 2.87 | 204 |
| DRQ125-681-R | 680 | 679.8 | 0.70 | 0.85 | 1.10 | 122 | 2719 | 0.350 | 0.425 | 4.42 | 244 |
| DRQ125-821-R | 820 | 828.0 | 0.60 | 0.77 | 1.49 | 135 | 3312 | 0.301 | 0.385 | 5.96 | 270 |
| DRQ125-102-R | 1000 | 1008 | 0.57 | 0.70 | 1.69 | 149 | 4032 | 0.283 | 0.350 | 6.76 | 298 |

- Open Circuit Inductance Test Parameters: 100 kHz, 0.25 V_{rms}, 0.0 Adc
Parallel: (1,2 -4,3) Series: (1-4) tie (2-3)
- RMS current for an approximate DT of 40 °C without core loss.
It is recommended that the temperature of the part not exceed +125 °C.
- Peak current for approximately 30% roll-off at +20 °C
- DCR limits @ +20 °C
- Applied Volt-Time product (V-μs) across the inductor. This value represents the applied V-μs at 100 kHz necessary to generate a core loss equal to 10% of the total losses for a 40 °C temperature rise.

- Turns Ratio (1:3):(2-4) 1:1
- Part number definition: DRQxxx-yyy-
- DRQxxx = product code and size,
- yyy = inductance value in μH,
- R = decimal point. If no R is present, third character = # of zeros
- "-R" suffix = RoHS compliant

Product specifications

| Part Number | Rated Inductance (μH) | Parallel Ratings | | | | | Series Ratings | | | | |
|--------------|-----------------------|----------------------------|-----------------------------------|--|-------------------------|-------------------------|----------------------------|-----------------------------------|--|-------------------------|-------------------------|
| | | OCL ¹ ±20% (μH) | I _{rms} ² (A) | I _{sat} ³ (A) Peak | DCR Ω ⁴ typ. | Volt ⁵ μ-sec | OCL ¹ ±20% (μH) | I _{rms} ² (A) | I _{sat} ³ (A) Peak | DCR Ω ⁴ typ. | Volt ⁵ μ-sec |
| DRQ127-R47-R | 0.47 | 0.419 | 17.9 | 56.0 | 0.00195 | 3.50 | 1.676 | 8.94 | 28 | 0.0078 | 7.00 |
| DRQ127-1R0-R | 1.00 | 0.821 | 15.5 | 40.0 | 0.00261 | 4.90 | 3.284 | 7.74 | 20 | 0.0104 | 9.80 |
| DRQ127-1R5-R | 1.50 | 1.357 | 13.5 | 31.1 | 0.00341 | 6.30 | 5.428 | 6.77 | 15.6 | 0.0137 | 12.60 |
| DRQ127-2R2-R | 2.20 | 2.027 | 12.5 | 25.5 | 0.00373 | 7.70 | 8.108 | 6.23 | 12.7 | 0.0161 | 15.4 |
| DRQ127-3R3-R | 3.30 | 2.831 | 10.4 | 21.5 | 0.00567 | 9.10 | 11.32 | 5.23 | 10.8 | 0.0229 | 18.2 |
| DRQ127-4R7-R | 4.70 | 4.841 | 8.25 | 16.5 | 0.00917 | 11.9 | 19.36 | 4.13 | 8.24 | 0.0367 | 23.8 |
| DRQ127-6R8-R | 6.80 | 7.387 | 7.34 | 13.3 | 0.0116 | 14.7 | 29.55 | 3.67 | 6.67 | 0.0465 | 29.4 |
| DRQ127-8R2-R | 8.20 | 8.861 | 6.32 | 12.2 | 0.0157 | 16.1 | 35.44 | 3.16 | 6.09 | 0.0627 | 32.2 |
| DRQ127-100-R | 10.0 | 10.47 | 6.04 | 11.2 | 0.0172 | 17.5 | 41.88 | 3.02 | 5.60 | 0.0686 | 35.0 |
| DRQ127-150-R | 15.0 | 14.09 | 5.03 | 9.66 | 0.0247 | 20.3 | 56.36 | 2.51 | 4.83 | 0.0990 | 40.6 |
| DRQ127-220-R | 22.0 | 22.93 | 4.00 | 7.57 | 0.0391 | 25.9 | 91.72 | 2.00 | 3.78 | 0.157 | 51.8 |
| DRQ127-330-R | 33.0 | 33.92 | 3.23 | 6.22 | 0.0600 | 31.5 | 135.7 | 1.61 | 3.11 | 0.241 | 63.0 |
| DRQ127-470-R | 47.0 | 47.05 | 2.95 | 5.28 | 0.0719 | 37.1 | 188.2 | 1.47 | 2.64 | 0.288 | 74.2 |
| DRQ127-680-R | 68.0 | 66.48 | 2.44 | 4.44 | 0.105 | 44.1 | 265.9 | 1.22 | 2.22 | 0.421 | 88.2 |
| DRQ127-820-R | 82.0 | 79.75 | 2.09 | 4.06 | 0.143 | 48.3 | 319.0 | 1.04 | 2.03 | 0.573 | 96.6 |
| DRQ127-101-R | 100 | 99.31 | 1.96 | 3.64 | 0.163 | 53.9 | 397.2 | 0.980 | 1.82 | 0.653 | 107.8 |
| DRQ127-151-R | 150 | 144.9 | 1.59 | 3.01 | 0.247 | 65.1 | 579.6 | 0.796 | 1.51 | 0.989 | 130.2 |
| DRQ127-221-R | 220 | 221.5 | 1.29 | 2.43 | 0.376 | 80.5 | 886.0 | 0.645 | 1.22 | 1.50 | 161 |
| DRQ127-331-R | 330 | 323.6 | 1.04 | 2.01 | 0.574 | 97.3 | 1294 | 0.522 | 1.01 | 2.30 | 195 |
| DRQ127-471-R | 470 | 467.1 | 0.85 | 1.68 | 0.861 | 117 | 1868 | 0.427 | 0.838 | 3.44 | 234 |
| DRQ127-681-R | 680 | 676.7 | 0.76 | 1.39 | 1.08 | 141 | 2707 | 0.380 | 0.697 | 4.32 | 282 |
| DRQ127-821-R | 820 | 818.1 | 0.65 | 1.27 | 1.47 | 155 | 3272 | 0.325 | 0.633 | 5.88 | 310 |
| DRQ127-102-R | 1000 | 1005 | 0.61 | 1.14 | 1.66 | 172 | 4020 | 0.307 | 0.571 | 6.64 | 344 |

1. Open Circuit Inductance Test Parameters: 100 kHz, 0.25 V_{rms}, 0.0 Adc
Parallel: (1,2 -4,3) Series: (1-4) tie (2-3)
2. RMS current for an approximate DT of 40 °C without core loss.
It is recommended that the temperature of the part not exceed +125 °C.
3. Peak current for approximately 30% roll-off at 20°C
4. DCR limits @ +20 °C
5. Applied Volt-Time product (V-μs) across the inductor. This value represents the applied V-μs at 100 kHz necessary to generate a core loss equal to 10% of the total losses for a 40 °C temperature rise.

6. Turns Ratio (1:3):(2-4) 1:1
7. Part number definition: DRQxxx-yyy-
- DRQxxx = product code and size,
- yyy = inductance value in μH,
- R = decimal point. If no R is present, third character = # of zeros
- "-R" suffix = RoHS compliant

Dimensions - mm

DRQ73

Top View



Side View



Recommended Pad Layout



Dual Inductor Mode

Series Mode

Bottom View



Schematic

Dual Inductor

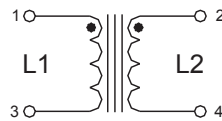

Series Mode

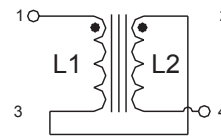

Parallel Mode



DRQ74

Top View



Side View



Recommended Pad Layout



Dual Inductor Mode

Series Mode

Bottom View



Schematic

Dual Inductor



Series Mode



Parallel Mode



= Inductance value per family chart
wlyy = Date code
R = Revision level
Dot indicates pin #1
Do not route traces or vias underneath the inductor

Dimensions - mm

DRQ125



DRQ127



= Inductance value per family chart
 wwllly = (date code)
 R = revision level
 Dot indicates pin #1
 Do not route traces or vias underneath the inductor

Dual winding, high power density, shielded drum core power inductors

Packaging information- mm

DRQ73

Supplied in tape and reel packaging,
1350 parts per reel, 13" diameter reel.

Ao=7.90mm
Bo=7.90mm
Ko=3.80mm

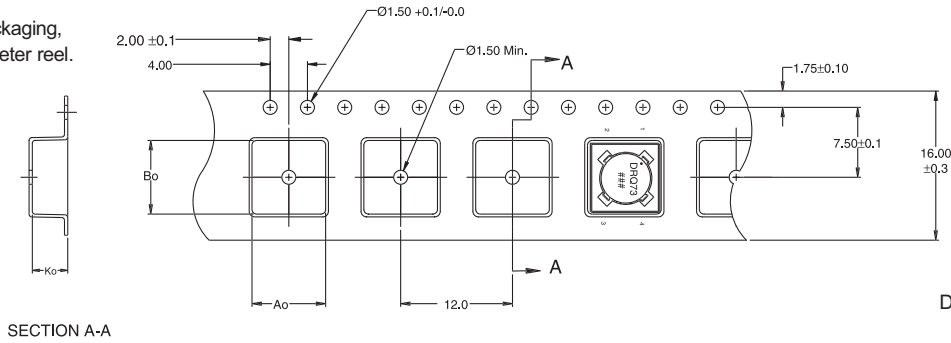

DRQ74

Supplied in tape and reel packaging,
1100 parts per reel, 13" diameter reel.

Ao=7.90mm
Bo=7.90mm
Ko=4.70mm

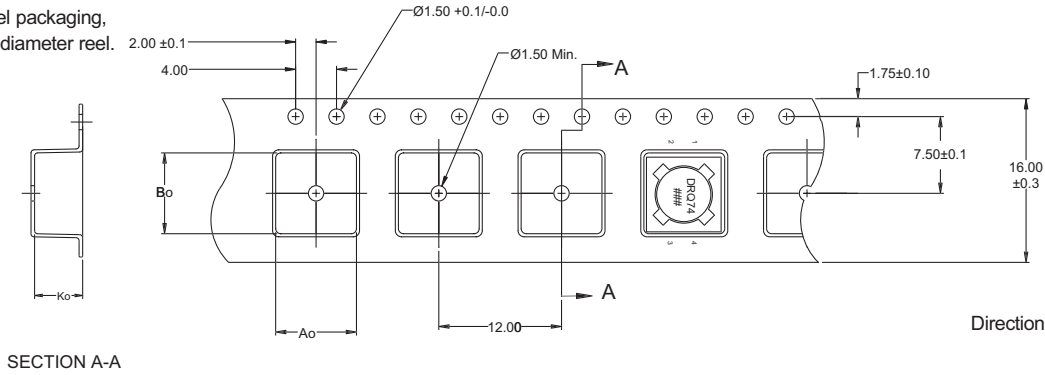

DRQ125

Supplied in tape and reel packaging,
600 parts per reel, 13" diameter reel.

Ao=13.00mm
Bo=13.00mm
Ko=6.30mm

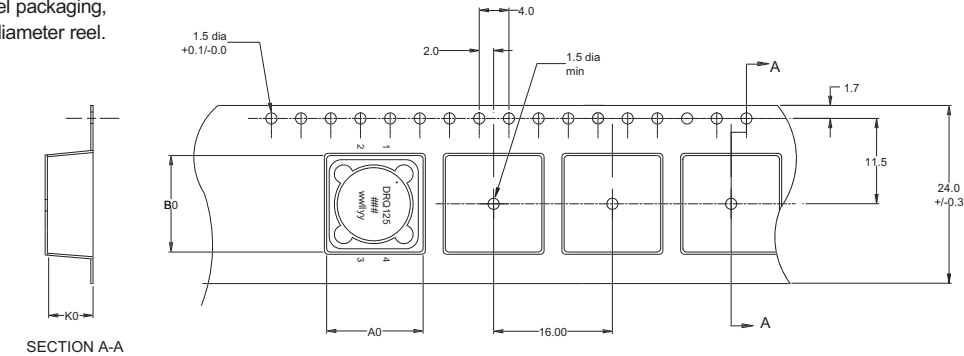

DRQ127

Supplied in tape and reel packaging,
350 parts per reel, 13" diameter reel.

Ao=13.00mm
Bo=13.00mm
Ko=8.30mm

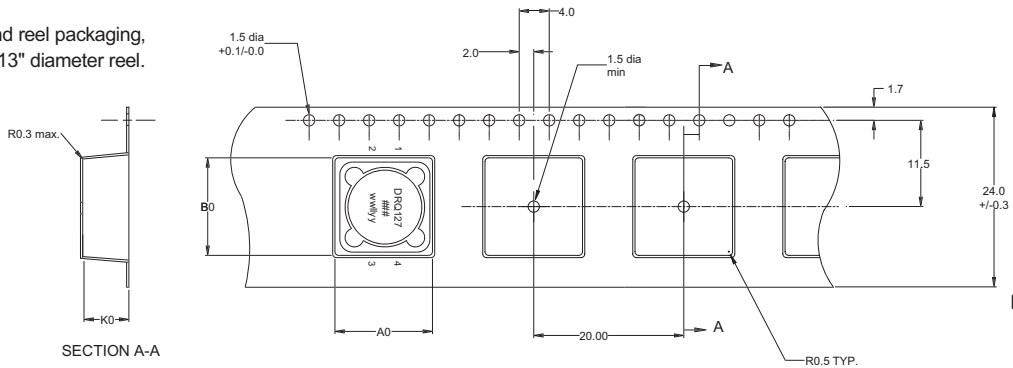

Dimensions are in millimeters.

Core loss



Inductance characteristics

DRQ73



DRQ74

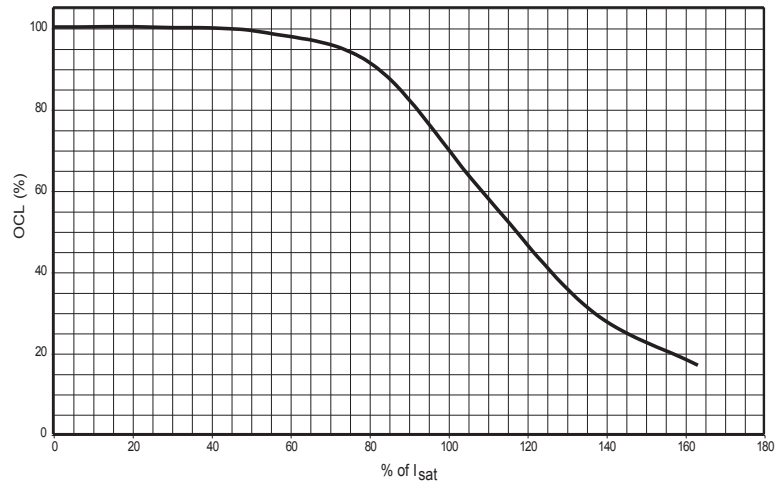

DRQ125



DRQ127



Solder Reflow Profile



Table 1 - Standard SnPb Solder (T_c)

| Package Thickness | Volume <350 mm ³ | Volume ≥ 350 mm ³ |
|-------------------|-------------------------------|-----------------------------------|
| <2.5 mm | 235°C | 220°C |
| ≥ 2.5 mm | 220°C | 220°C |

Table 2 - Lead (Pb) Free Solder (T_c)

| Package Thickness | Volume <350 mm ³ | Volume $350 - 2000$ mm ³ | Volume >2000 mm ³ |
|-------------------|-------------------------------|-------------------------------------|--------------------------------|
| <1.6 mm | 260°C | 260°C | 260°C |
| 1.6 – 2.5mm | 260°C | 250°C | 245°C |
| >2.5 mm | 250°C | 245°C | 245°C |

Reference JDEC J-STD-020

| Profile Feature | Standard SnPb Solder | Lead (Pb) Free Solder |
|--|----------------------|-----------------------|
| Preheat and Soak | | |
| • Temperature min. (T_{smin}) | 100°C | 150°C |
| • Temperature max. (T_{smax}) | 150°C | 200°C |
| • Time (T_{smin} to T_{smax}) (t_s) | 60-120 Seconds | 60-120 Seconds |
| Average ramp up rate T_{smax} to T_p | 3°C/ Second Max. | 3°C/ Second Max. |
| Liquidous temperature (T_L) | 183°C | 217°C |
| Time at liquidous (t_L) | 60-150 Seconds | 60-150 Seconds |
| Peak package body temperature (T_p)* | Table 1 | Table 2 |
| Time (t_p)** within 5 °C of the specified classification temperature (T_c) | 20 Seconds** | 30 Seconds** |
| Average ramp-down rate (T_p to T_{smax}) | 6°C/ Second Max. | 6°C/ Second Max. |
| Time 25°C to Peak Temperature | 6 Minutes Max. | 8 Minutes Max. |

* Tolerance for peak profile temperature (T_p) is defined as a supplier minimum and a user maximum.

** Tolerance for time at peak profile temperature (t_p) is defined as a supplier minimum and a user maximum.

Life Support Policy: Eaton does not authorize the use of any of its products for use in life support devices or systems without the express written approval of an officer of the Company. Life support systems are devices which support or sustain life, and whose failure to perform, when properly used in accordance with instructions for use provided in the labeling, can be reasonably expected to result in significant injury to the user.

Eaton reserves the right, without notice, to change design or construction of any products and to discontinue or limit distribution of any products. Eaton also reserves the right to change or update, without notice, any technical information contained in this bulletin.

Eaton
Electronics Division
1000 Eaton Boulevard
Cleveland, OH 44122
United States
www.eaton.com/electronics

© 2017 Eaton
All Rights Reserved Printed in USA
Publication No. DS4311 BU-SB14113
September 2017

Eaton is a registered trademark.

All other trademarks are property of their respective owners.