

## Main

Range of product	OsiSense XC
Series name	Standard format
Product or component type	Limit switch
Device short name	XCKT
Sensor design	Compact
Body type	Fixed
Head type	M18 plunger head
Material	Plastic
Body material	Plastic
Head material	Zamak
Fixing mode	By the head
Movement of operating head	Linear
Type of operator	Spring return plunger metal
Type of approach	Vertical approach 1 direction
Number of poles	2
Contacts type and composition	1 NC + 1 NO
Contact operation	Snap action

## Complementary

Switch actuation	On end
Electrical connection	Screw-clamp terminals, clamping capacity: 1 x 0.34...2 x 1.5 mm <sup>2</sup>
Cable entry	2 entries tapped for M16 x 1.5 cable gland, cable outer diameter: 0.16...0.31 in (4...8 mm)
Contacts insulation form	Zb
Positive opening	With
Positive opening minimum force	45 N
Minimum force for tripping	15 N
Minimum actuation speed	0.01 m/min
Maximum actuation speed	1.64 ft/s (0.5 m/s)
Repeat accuracy	0.1 mm on the tripping points with 1 million operating cycles
Contact code designation	Q300, DC-13 (U <sub>e</sub> = 250 V, I <sub>e</sub> = 0.27 A) conforming to EN/IEC 60947-5-1 appendix A A300, AC-15 (U <sub>e</sub> = 240 V, I <sub>e</sub> = 3 A), I <sub>the</sub> = 10 A conforming to EN/IEC 60947-5-1 appendix A
[Ui] rated insulation voltage	500 V degree of pollution 3 conforming to IEC 60947-1 300 V conforming to UL 508 300 V conforming to CSA C22.2 No 14
Resistance across terminals	<= 25 MOhm conforming to IEC 60255-7 category 3
[Uimp] rated impulse withstand voltage	6 kV conforming to IEC 60664 6 kV conforming to IEC 60947-1
Short-circuit protection	10 A by gG cartridge fuse
Electrical durability	5000000 cycles, DC-13, 120 V, 4 W, operating rate: <= 60 cyc/mn, load factor: 0.5 conforming to IEC 60947-5-1 appendix C 5000000 cycles, DC-13, 24 V, 10 W, operating rate: <= 60 cyc/mn, load factor: 0.5 conforming to IEC 60947-5-1 appendix C 5000000 cycles, DC-13, 48 V, 7 W, operating rate: <= 60 cyc/mn, load factor: 0.5 conforming to IEC 60947-5-1 appendix C
Mechanical durability	10000000 cycles
Width	2.28 in (58 mm)
Height	2.01 in (51 mm)
Depth	1.18 in (30 mm)



- (2) 4 elongated holes  $\varnothing$  4.3 x 6.3 mm on 22/42mm ctrs, 4 holes  $\varnothing$  4.3 on 20/40 mm ctrs.
- (3) 2 x  $\varnothing$  3 holes for support studs, depth 4 mm.
- (4) Fixing nut thickness 3.5 mm.

## Mounting with Cable Entry

### Position of Cable Gland

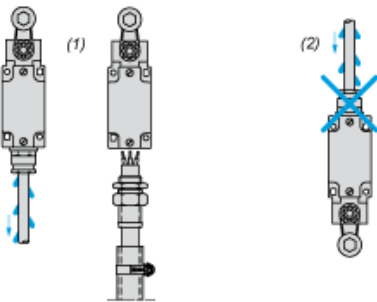

- (1) Recommended
- (2) To be avoided

## Panel Mounting

### Mounting and Fixing Limit Switches by the Head

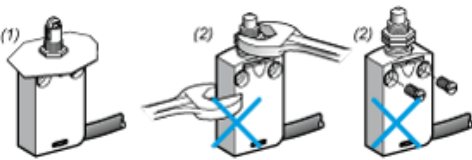

- (1) Recommended
- (2) Forbidden

## Setting-up

### Plunger or Multi-directional Heads

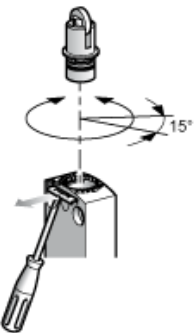

## Wiring Diagram

### 2-pole NC + NO Snap Action

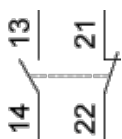

## Characteristics of Actuation

### Switch Actuation on End

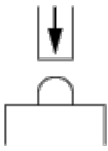

## Functionnal Diagram

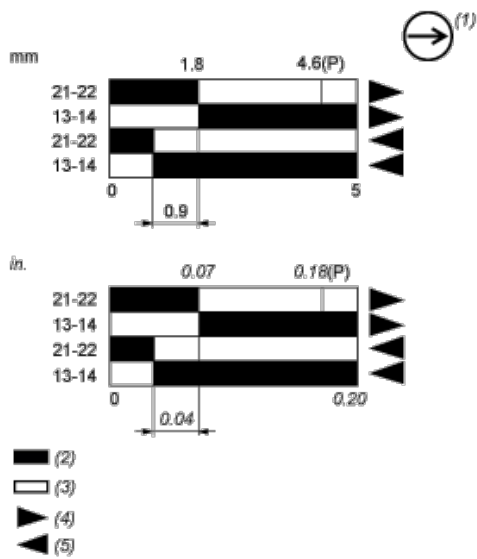

(P) Positive opening point

(1) NC contact with positive opening operation

(2) Closed

(3) Open

(4) Tripping

(5) Resetting