

THIS DOCUMENT IS THE PROPERTY OF
KEYSTONE ELECTRONICS CORP. AND
SHALL NOT BE REPRODUCED, DISTRIBUTED
OR USED AS A BASIS FOR MANUFACTURE
WITHOUT PRIOR WRITTEN PERMISSION
FROM KEYSTONE ELECTRONICS CORP.

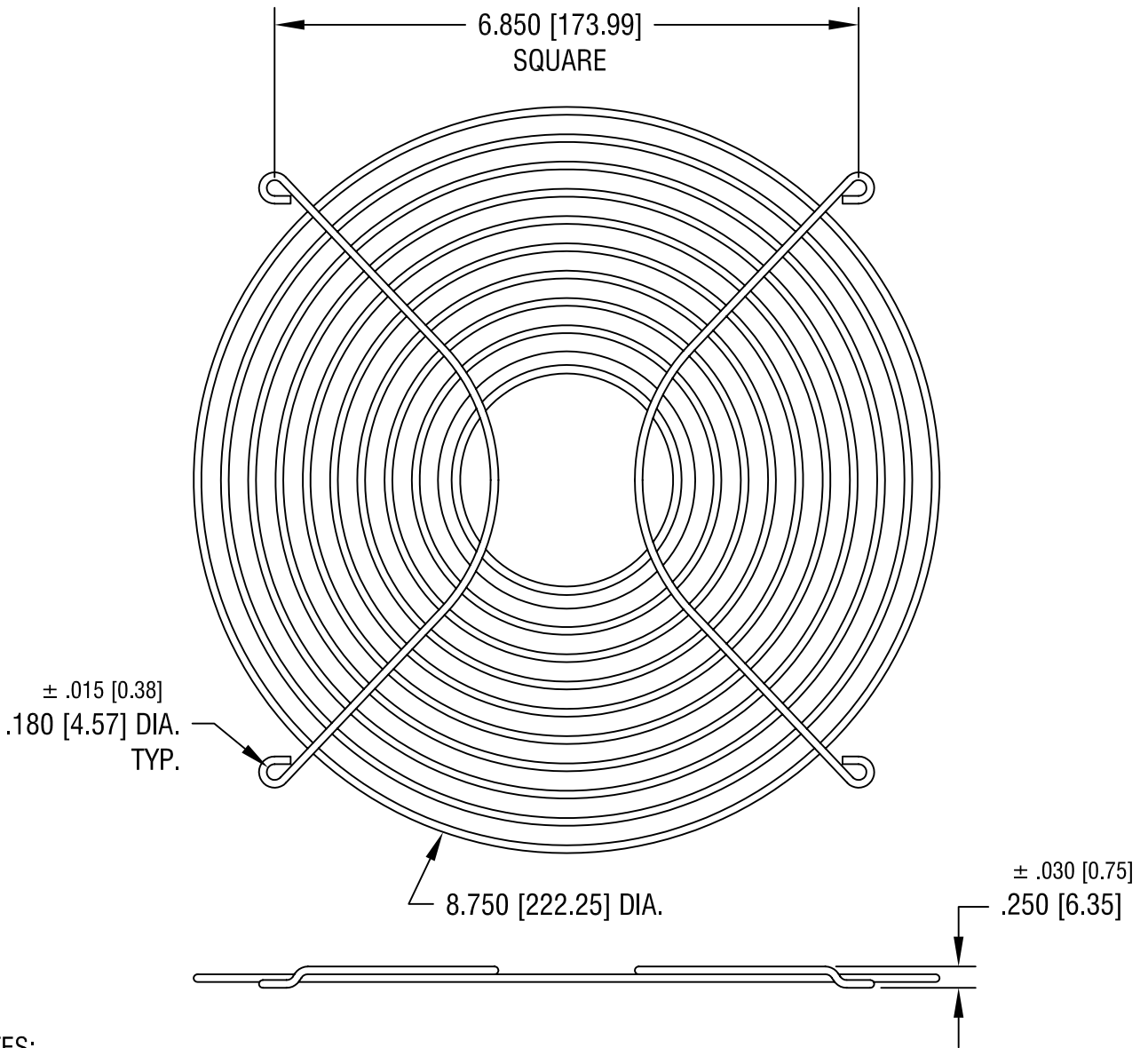

NOTES:

1. RINGS: .091 [2.31] DIA.
RIBS: .091 [2.31] DIA.
2. FINISH - NICKEL CHROME PLATE

KEYSTONE ELECTRONICS CORP.			
ASTORIA, N.Y. 11105-2017			
PART NAME			
FAN/FINGER GUARD (254MM)			
MATERIAL			
STEEL			
FINISH		DRN BY	DATE
AS NOTED		BOONE	3.7.06
		APP'D	SCALE
		LN	.5X
TOLERANCES		INCH	[MM]
DECIMAL		± .020	[± 0.50]
ANGULAR		± 1°	
UNLESS OTHERWISE SPECIFIED		CODE	DWG NO.
		C/M	8457

DATE	DESCRIPTION	REV.