

**SH Series**



**Agency Approvals**

Agency	Agency File Number
	E128662

**Two Electrode GDT Graphical Symbol**



**Additional Information**



**Datasheet**



**Resources**



**Samples**

**Description**

The Littelfuse SH Gas Discharge Tubes (GDT) series provides high levels of protection against fast rising transients caused by lightning disturbances. It has a surge rating of 5kA, 8/20 $\mu$ s. Offered in a Squared Surface Mount package, which helps to make pick and place on PCB process easier.

This GDT series is perfectly suited for broadband equipment applications. The GDT's low off-state capacitance is compatible with high bandwidth applications and this capacitance loading value does not vary if the voltage across the GDT changes.

The Littelfuse SH Gas Discharge Tube (GDT) series are specifically designed for protection of electrical, multimedia, and communication equipment against over voltage transients in surface mount assembly applications.

**Features**

- Excellent response to fast rising transients
- GHz working frequency
- 5kA, 8/20 $\mu$ s surge capability as defined by IEC 61000-4-5 2<sup>nd</sup> Edition
- UL recognized
- Offered with squared body package
- Non-Radioactive
- Ultra Low capacitance (<0.7pF)
- Lead-free and RoHS compliant

**Applications**

- CATV equipment
- Antennas
- RS 485
- Telecom Base Station
- Power Supply AC Main
- G.fast
- EV power Charging
- Inverter/Variable Frequency Drivers (VFDs)
- IEEE 802.3 compliant Ethernet interfaces
- Broad Band equipment
- xDSL, ADSL, ADSL2, VDSL, and VDSL2
- Medical Electronics
- Test Equipment
- General Telecom Equipment
- Renewable Energy

### Electrical Characteristics

Part Number	Component Specifications (at 25°C)							Life Ratings					
	DC Breakdown in Volts (@ 100V/s)			Maximum Impulse Break-down Voltage		Maximum Impulse Discharge Current (8/20µs)	Insulation Resistance	Capacitance (@ 1MHz)	Impulse Discharge Current (8/20µs)	AC Discharge Current (50Hz, 1sec)	AC Discharge Current (9 Cycles @50Hz)	DC Holdover Voltage (<150ms)*	Impulse Life (10/1000µs) (100A)
	MIN	TYP	MAX	@ 100V/µs	1000V/µs	1 Time	MIN	MAX	MAX	MIN	MIN		MIN
SH75	60	75	90	600	700	6kA	1GΩ @50V	0.7pf	10 Shots @ (5kA) 1 Shot at 6kA**	5A	15A	52V	300 Shots
SH90	72	90	108	600	700		52V						
SH145	116	145	174	600	700		52V						
SH230	186	230	276	600	700		80V						
SH250	200	250	300	600	700		135V						
SH300	240	300	360	650	800		135V						
SH350	280	350	420	750	900		135V						
SH400	360	400	480	850	1000		135V						
SH470	376	470	564	900	1100		150V						
SH600	480	600	720	1000	1200		150V						

Note:

\* Reference REA PE-80, 0.2A, tested to ITU-T Rec K.12 and REA PE 80 <150 ms.

\*\* DC spark-over may exceed ± 25% after discharge, but will continue to protect without venting

### Product Characteristics

<b>Materials</b>	Device Tin Plated 17.5 ± 12.5 Microns Construction: Ceramic Insulator
<b>Storage and Operational Temperature</b>	-40 to +90°C

### Typical Insertion Loss

@1.0GHz = 0.08dB
@1.4GHz = 0.16dB
@1.8GHz = 0.26dB
@2.0GHz = 0.33dB
@2.4GHz = 0.47dB
@2.8GHz = 0.59dB
@3.1GHz = 0.70dB
@3.5GHz = 0.89dB
@4.0GHz = 1.24dB

Note: Insertion data for customer reference only, application testing needed for verification.

### Voltage Vs. Time Characteristic

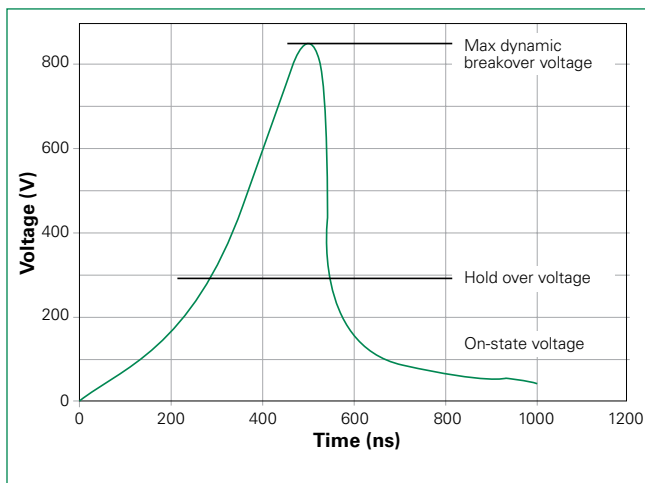

Note: Tested per 1kV/µs waveform

**Soldering Parameters - Reflow Soldering (Surface Mount Devices)**

<b>Reflow Condition</b>		Pb – Free assembly
<b>Pre Heat</b>	- Temperature Min ( $T_{s(min)}$ )	150°C
	- Temperature Max ( $T_{s(max)}$ )	200°C
	- Time (Min to Max) ( $t_s$ )	60 – 180 secs
<b>Average ramp up rate (Liquidus Temp (<math>T_L</math>) to peak)</b>		3°C/second max
<b><math>T_{s(max)}</math> to <math>T_L</math> - Ramp-up Rate</b>		5°C/second max
<b>Reflow</b>	- Temperature ( $T_L$ ) (Liquidus)	217°C
	- Temperature ( $t_L$ )	60 – 150 seconds
<b>Peak Temperature (<math>T_p</math>)</b>		260 <sup>+0/-5</sup> °C
<b>Time within 5°C of actual peak Temperature (<math>t_p</math>)</b>		10 – 30 seconds
<b>Ramp-down Rate</b>		6°C/second max
<b>Time 25°C to peak Temperature (<math>T_p</math>)</b>		8 minutes Max.
<b>Do not exceed</b>		260°C

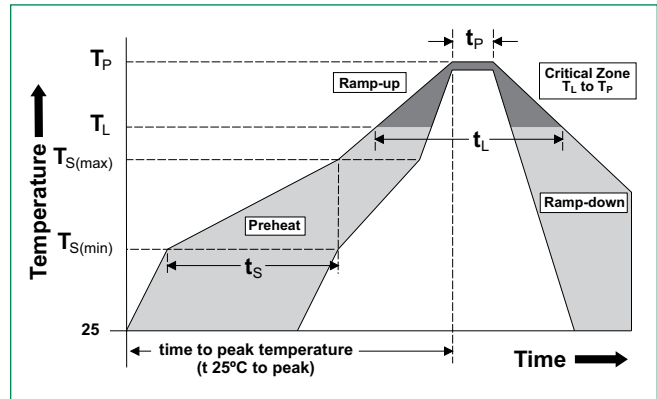

**Product Dimensions**

Dimensions in millimeters

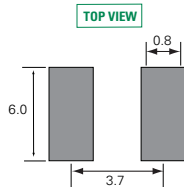
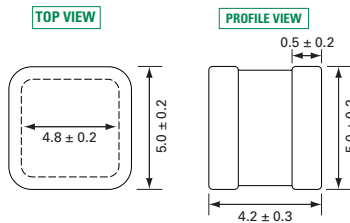

Recommended Soldering Pad Layout

**Product Marking**

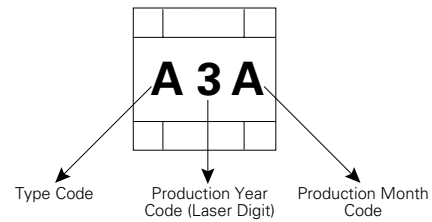

Type Code	
A	SH75
B	SH90
S	SH145
D	SH230
R	SH250
E	SH300
G	SH350
I	SH400
P	SH470
V	SH600

Month Code	
A	January
B	February
C	March
D	April
E	May
F	June
G	July
H	August
I	September
J	October
K	November
L	December

**Part Numbering System and Ordering Information**

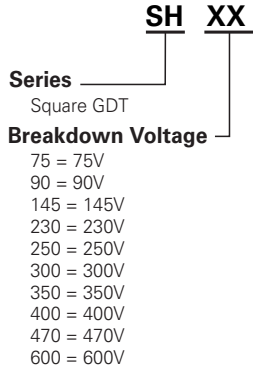

**Taping and Reel Specifications**

**Taping**

Unit = mm

Item	Spec	Item	Spec
P	12.0±0.1	D	Ø1.55±0.05
P0	4.0±0.1	W	16.0±0.3
A	5.4±0.1	K0	5.4±0.1
B	4.6±0.1	t	0.5±0.05

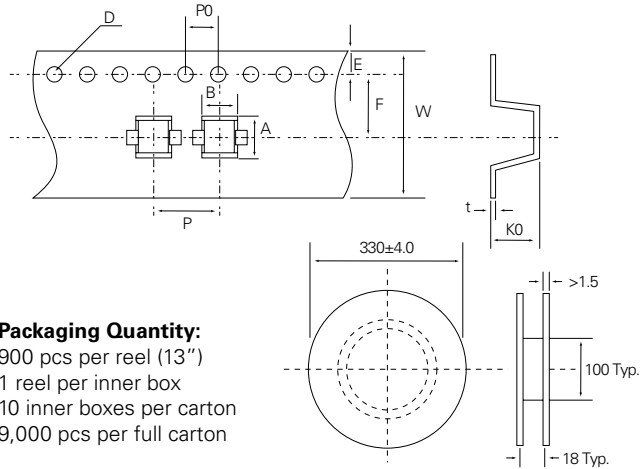

**Packaging Quantity:**  
900 pcs per reel (13")  
1 reel per inner box  
10 inner boxes per carton  
9,000 pcs per full carton

**Disclaimer Notice** - Information furnished is believed to be accurate and reliable. However, users should independently evaluate the suitability of and test each product selected for their own applications. Littelfuse products are not designed for, and may not be used in, all applications. Read complete Disclaimer Notice at: [www.littelfuse.com/disclaimer-electronics](http://www.littelfuse.com/disclaimer-electronics).