



### FEATURES

- 10K cycles mechanical life version available
- Endless rotation upon request
- RoHS compliant materials ready
- Carbon resistive element
- Plastic substrate
- Over-moulding manufacturing technique
- SMD mounting
- RoHS reflow soldering capable
- Wiper positioned at 50%
- Both sides cross slot easy adjustment
- Accidental rotor movement protected
- Traceability insured through date code marking
- IP54 protection according to IEC 60529

### MECHANICAL SPECIFICATIONS

- Mechanical rotation angle:  $280^\circ \pm 10^\circ$
- Electrical rotation angle:  $245^\circ \pm 25^\circ$
- Torque: 0.2 to 3 Ncm. (0.28 to 4.2 in-oz)
- Stop torque: > 7.5 Ncm. ( 10.5 in-oz)
- Mechanical life\*: up to 10K cycles

\* depending on application

### ELECTRICAL SPECIFICATIONS

- Range of values\*
- "E" version:  $1K\Omega \leq R_n \leq 500K\Omega$  (1.0 - 2.0 - 2.2 - 2.5 - 4.7 - 5.0)
- Std version:  $250\Omega \leq R_n \leq 500K\Omega$  (1.0 - 2.0 - 2.2 - 2.5 - 4.7 - 5.0)
- Tolerance:  $250\Omega \leq R_n \leq 500K\Omega$  .....  $\pm 30\%$
- Max. Voltage: 100 VDC
- Nominal Power 50°C (122°F) (see power rating curve): 0.1W
- Taper: linear
- End resistance:  $\leq 2\% R_n$  (10Ω min.)
- Equivalent noise resistance:  $\leq 5\%$
- Operating temperature\*\*: -25°C + 70°C (-13°F + 158°F)

\* Others: check availability.

\*\* Up to 85°C depending on application.

### HOW TO ORDER

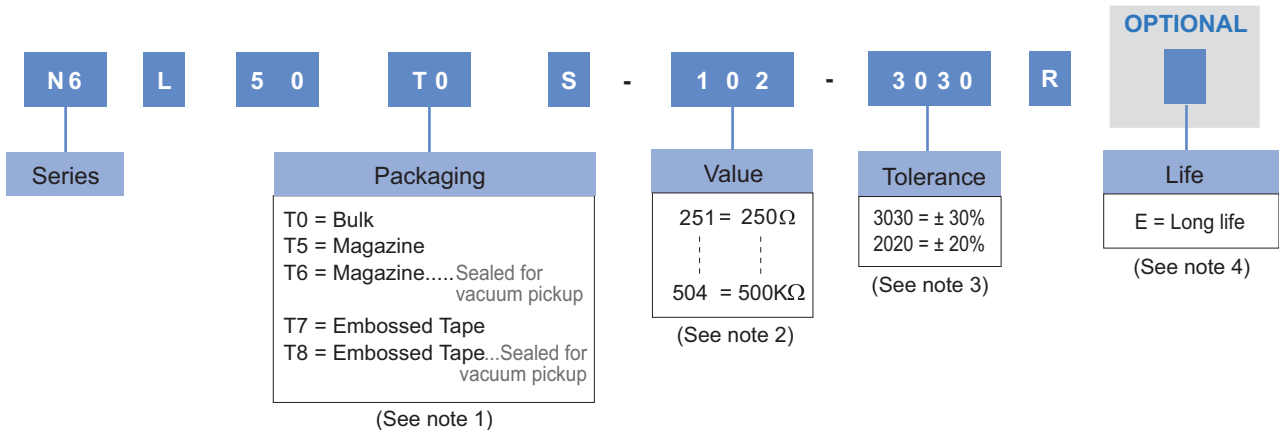

### NOTES:

(1) - "T7", "T8" Embossed Tape 750 Units per Reel. Diameter: 330 mm, aprox. thickness: 30 mm.  
 - "T6" and "T8" are sealed for vacuum pickup (sticker at the bottom side)

(2) Value: Example: Code: 10 2 = 1 K  
 Number of zeros  
 First two digits of the value.

(3) Standard is 30%. For 20% and below tolerances, please check availability.

(4) Life: • Standard = 100 cycles • Long = 10K cycles

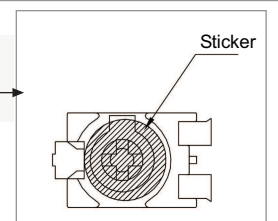

\* Version with sticker on TOP side is available under request

NOTE: The information contained here should be used for reference purposes only.  
 This project has been financially supported by the Spanish Technological Development Institute (CDTI).

## DIMENSIONS

N-6 L 50 T0 S

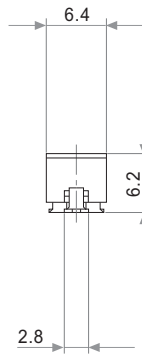
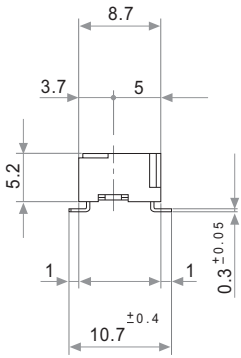

### SOLDER PADS

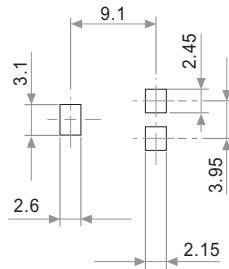

## STICKER ON TOP

Special Version  
100410-G

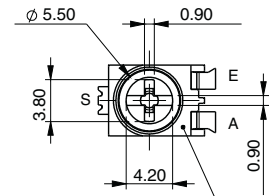

Sticker on this side

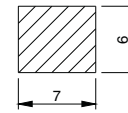

## KNOB Ref.: 5680

## SHAFT Ref.: 6133

## RoHS RECOMMENDED REFLOW PROFILE

Please order both Knob and Shaft separately. They should be inserted after the reflow process. If you wish to use your own custom plastic shaft/knob/actuator please contact Piher for advice about compatible materials.

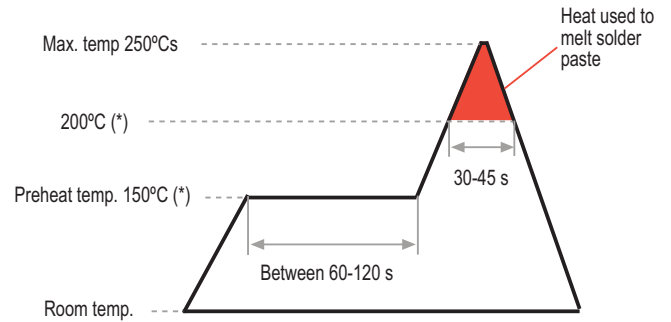
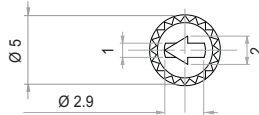
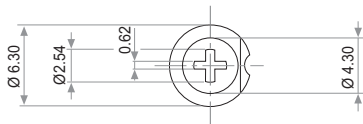
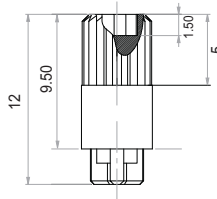
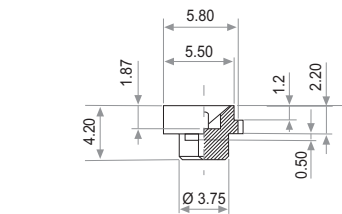

(\*) Melting point temp. depends on solder properties

The recommended reflow profile is provided as a guideline. Optimal profile may differ due to oven type, assembly layout or other design or process variables. Customers should verify actual device performance in their specific application and reflow process. Please contact Piher if you require additional support.

## PACKAGING

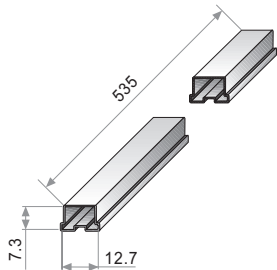

**T5 / T6 MAGAZINE**  
Units per magazine: 80

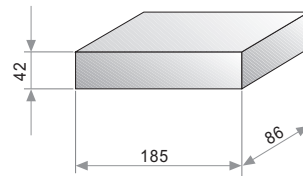

**T0 BULK**  
500 Units per box.

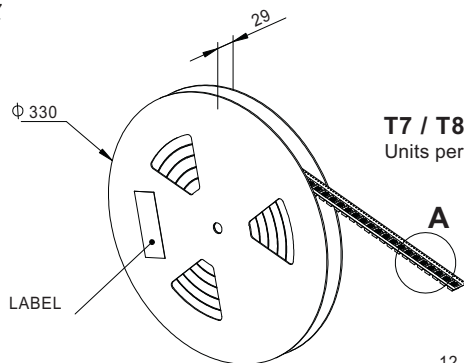

**T7 / T8 EMBOSSED TAPE**  
Units per reel: 750

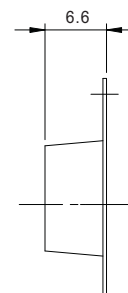
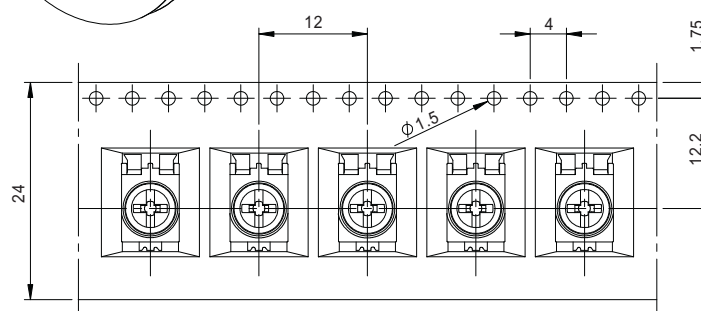
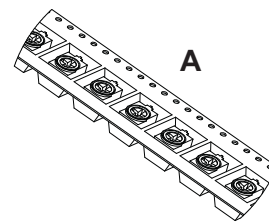

DIRECTION OF UNREELING

**TESTS** **TYPICAL VARIATIONS** **POWER RATING CURVE**

ELECTRICAL LIFE	1.000 h. @ 50°C: 0.1 W	±10 %
MECHANICAL LIFE (CYCLES)	<b>"E" version:</b> 10K @ 30 CPM	± 4 % (Rn < 1 M Ω)
	<b>Std version:</b> 100 @ 10 CPM ...15 CPM	±3 % (Rn < 1 M Ω)
TEMPERATURE COEFFICIENT	-25°C; +70°C	±300 ppm (1K ≤ Rn ≤ 100K)
THERMAL CYCLING	16 h. @ 85°C; 2h. @ -25°C	±5 %
DAMP HEAT	500 h. @ 40°C @ 95% HR	±5 %
VIBRATION (for each plane X,Y,Z)	2 h. @ 10 Hz. ... 55 Hz.	±2 %

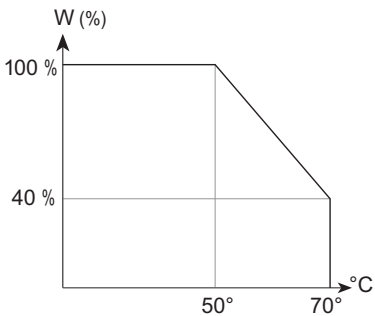

NOTE: Out of range values may not comply with these results.

**RECOMMENDED CONNECTIONS**

Piher potentiometer's recommended connection circuit for a position sensor or control application. (voltage divider circuit electronic design).

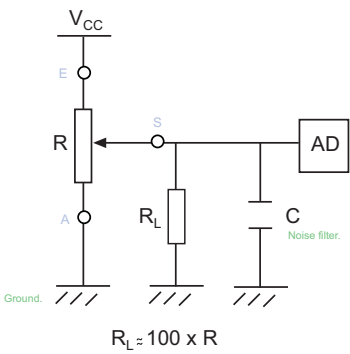

**POSITIONING**

This mark in the rotor shows the wiper's position.

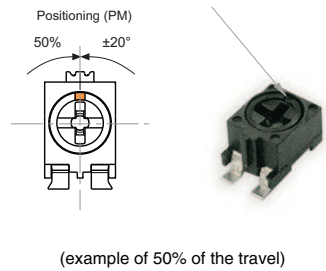

**Disclaimer**

The product information in this catalogue is for reference purposes. Please consult for the most up to date and accurate design information.

Piher Sensors & Controls S.A., its affiliates, agents, and employees, and all persons acting on its or their behalf (collectively, "Piher"), disclaim any and all liability for any errors, inaccuracies or incompleteness contained herein or in any other disclosure relating to any product described herein.

Piher disclaims any and all liability arising out of the use or application of any product described herein or of any information provided herein to the maximum extent permitted by law. The product specifications do not expand or otherwise modify Piher's terms and conditions of sale, including but not limited to the warranty expressed therein, which apply to these products.

No licence, express or implied, by estoppel or otherwise, to any intellectual property rights is granted by this document or by any conduct of Piher.

The products shown herein are not designed for use in medical, life-saving, or life-sustaining applications unless otherwise expressly indicated. Customers using or selling Piher products not expressly indicated for use in such applications do so entirely at their own risk and agree to fully indemnify Piher for any damages arising or resulting from such use or sale. Please contact authorised Piher personnel to obtain written terms and conditions regarding products designed for such applications.

Product names and markings noted herein may be trademarks of their respective owners.

Information contained in and/or attached to this catalogue may be subject to export control regulations of the European Community, USA, or other countries. Each recipient of this document is responsible to ensure that usage and/or transfer of any information contained in this document complies with all relevant export control regulations. If you are in any doubt about the export control restrictions that apply to this information, please contact the sender immediately. For any Piher Exports, Note: All products / technologies are EAR99 Classified commodities. Exports from the United States are in accordance with the Export Administration Regulations. Diversion contrary to US law is prohibited.



All Piher products can be adapted to meet customer's requirements. Please always use the latest updated datasheets published at our website [www.piher.net](http://www.piher.net).