

# PC-Series

## PC-Series

### GFCI/ELCI & PANEL SEAL

The PC-Series, AC Residual Current Circuit Breaker with Overcurrent Protection (RCBO), combines the ground fault protection of a GFCI with the familiar overcurrent tripping characteristics of a normal circuit breaker. It detects lower level ground faults that do not trip ordinary circuit breakers, but could lead to shock hazards and fires in installations near water. Innovative features include status LED indicators distinguishing if a breaker is closed with line voltage present, or has opened due to leakage current, or has opened due to over current, or is closed with no line voltage present.



#### Resources:

[Configure a Complete Part](#)

[Download CAD & Sales Drawing >](#)

#### Product Highlights:

- Meets latest UL 943 standards
- GFCI self-test auto-monitoring & end-of-life indication
- Integrated push-to-reset button
- Overload, short circuit and ground fault protection in a single package
- Status LED indicators
- Single circuit solution for AC branch ground fault protection
- Optional panel seal

#### Typical Applications:

- Generators
- Water Heaters
- Battery Chargers
- Marine
- AC main ground fault protection for a boat's entire AC electrical system



**Carling Technologies®**

Innovative Designs. Powerful Solutions.

**Carling Technologies, Inc.**

60 Johnson Avenue, Plainville, CT 06062

Email: [sales@carlingtech.com](mailto:sales@carlingtech.com)

Application Support: [team2@carlingtech.com](mailto:team2@carlingtech.com)

Phone: 860.793.9281 Fax: 860.793.9231

[www.carlingtech.com](http://www.carlingtech.com)

# PC-Series Switch

## DESIGN FEATURES

### MOUNTING PLATE

Available in stainless steel or zinc chromate plated carbon steel



### OPTIONAL SEAL

IP66/67 panel seals provide ideal protection against salt spray, ozone, dust, water and most acids



### LEDs

Two separate lights that indicate power, ground fault leakage and end-of-life

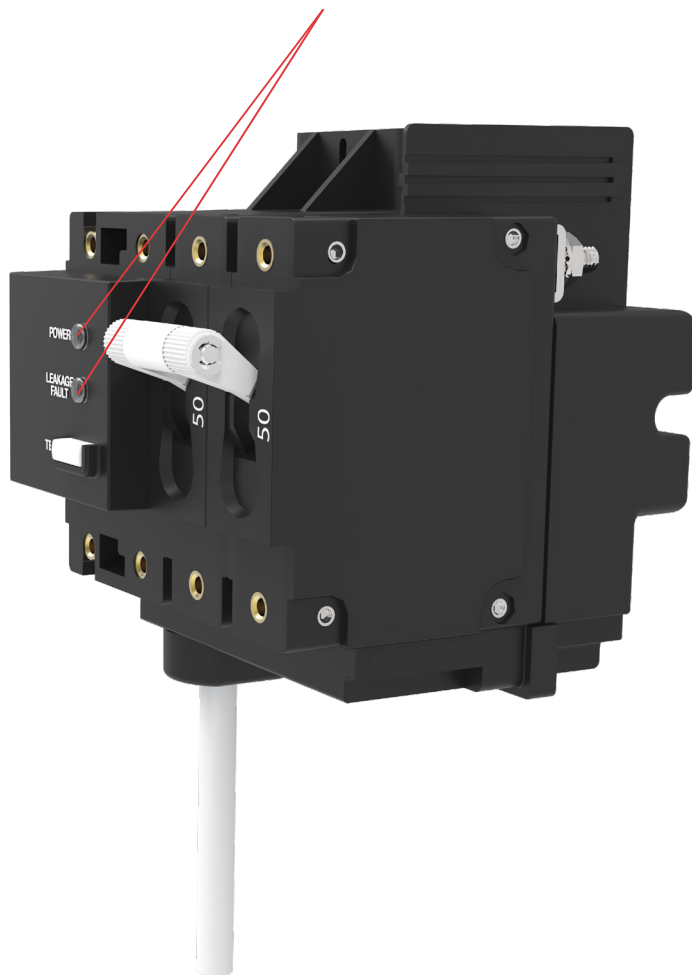

\*Manufacturer reserves the right to change product specification without prior notice.

## Electrical Tables

**Table A:** UL Listed & CSA Certified configurations as a Ground Fault Circuit Interruptor

PC-SERIES TABLE A: UL Listed / CSA 22.2 No. 144.1 Configurations as a Ground Fault Circuit Interruptor							
Circuit Configuration	Voltage			Current Rating (Amps)	Short Circuit Capacity (Amps)	Ground Fault Trip Level (Milliamps)	Notes
	Max Rating	Frequency (Hertz)	Phase				
Series	120	60	1	1 - 50	5000	6	1 or 2 Poles. One pole of a two pole unit must be Neutral
	120 / 240	60	1	1 - 50	5000	6	2 or 3 Poles. One pole of a three pole unit must be Neutral

**Table B:** UL Recognized as an Earth Leakage Circuit Interruptor - 120 and 120/240V

PC-SERIES TABLE B: UL Recognized Configurations as an Earth Leakage Circuit Interruptor							
Circuit Configuration	Voltage			Current Rating (Amps)	Short Circuit Capacity (Amps)	Ground Fault Trip Level (Milliamps)	Notes
	Max Rating	Frequency (Hertz)	Phase				
Series	120	50 / 60	1	1 - 50	5000	30	1 or 2 Poles. One pole of a two pole unit must be Neutral
	120 / 240	50 / 60	1	1 - 50	5000	30	2 or 3 Poles. One pole of a three pole unit must be Neutral
Series Ignition Protection	120	50 / 60	1	1 - 50	3000	30	1 or 2 Poles. One pole of a two pole unit must be Neutral
	120 / 240	50 / 60	1	1 - 50	5000	30	2 or 3 Poles. One pole of a three pole unit must be Neutral

**Table C:** UL Recognized as an Earth Leakage Circuit Interruptor - 240V

PC-SERIES TABLE C: UL Recognized Configurations as an Earth Leakage Circuit Interruptor - 240V							
Circuit Configuration	Voltage			Current Rating (Amps)	Short Circuit Capacity (Amps)	Ground Fault Trip Level (Milliamps)	Notes
	Max Rating	Frequency (Hertz)	Phase				
Series	240	50 / 60	1	1 - 30	5000	30	2 or 3 Poles. One pole of a three pole unit must be Neutral. Suffix 11
Series Ignition Protection	240	50 / 60	1	1 - 50	5000	30	2 or 3 Poles. One pole of a three pole unit must be Neutral. Suffix 12

Impedance (Across Circuit breaker only)

RESISTANCE, IMPEDANCE VALUES  
from Line to Load Terminals  
(Values Based on Series Trip Circuit Braker)

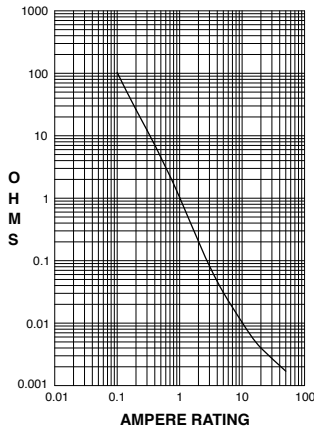

CURRENT (AMPS)	TOLERANCE (%)
0.10 - 5.0	± 15
5.10 - 20.0	± 25
20.10 - 50.0	± 35

## Agency Certifications

UL Standard 489

UL Standard 1077

UL Standard 943 & CSA 22.2 No. 144.1

UL Standard 1053

UL Standard 1500

Circuit Breakers, Molded Case,  
(Guide DIVQ, File E129899)

Supplementary Protectors

Class A Ground Fault Circuit Interrupters

Ground Fault Sensing and Relaying Equipment

Ignition Protection

**Electrical**

Current Ratings	50 Amps maximum
Voltage Rating	120 VAC, 120/240 VAC
Dielectric Strength	1480 VAC, 60Hz for 1 minute between all electrically isolated terminals
Insulation Resistance	Minimum of 100 Megohms at 500VDC
Leakage Current Trip Level	5±1 mA
Leakage Current Trip Time	≤ 25 ms complies with UL 943
EMI	UL 943 / IEC 61000-4-6, 0.5V 150KHz ~ 230 MHz
Operating Frequency	50/60 Hz
Reverse Polarity	A reversed Line / Load connection to the circuit breaker shall not cause damage to the device
Grounded Neutral	When neutral is grounded on load side of circuit
Overload	50 operations @ 600% of rated current on Breakers
Switched Neutral	2nd Pole on 120V and 3rd Pole on 120/240V, Optional
Manual Test	To be performed at least every month by pressing the test button on the GFCI to verify the device's ability to respond and trip when subjected to simulated leakage. Current imbalance is sufficient to cause tripping at 85% of rated voltage. Line Power at L1 is required.
GFCI Auto-Monitoring	Performed automatically without opening circuit breaker contacts or compromising ability to respond to ground or neutral faults. Automatic Self-Test performed automatically every time power is supplied within 5 seconds. Automatic Self-Test Frequency: 3 seconds. Line Power at L1 is required. Feedback when auto-monitoring Self-Test fails: Circuit breaker trips and cannot be reset and a visual indication is displayed (See Next Page).
GFCI Heartbeat Indicator	Successful Self Tests are followed by a flash of light per Next Page
GFCI End of Life	Circuit breaker trips and cannot be reset. A visual indication is displayed via the LED's located on the front of the device (See Next Page). Line Power at L1 is required.

**Mechanical**

Endurance	10,000 "On-Off" Operations at 6 per minute; 6000 with Rated Current & Voltage (3000 test button and 3000 manual operations) and 4000 on/off operations with no load.
Trip Free	Trips on short circuit, overload or leakage to ground, even when actuator is forcibly held in the "On" position

**Physical**

Number of Poles	1-pole (1 Circuit Breaker + 1 GFCI Sensor Module), 120V. 2-pole (2 Circuit Breakers + 1 GFCI Sensor Module), 120/240V or 120V with Switched Neutral. 3-pole (3 Circuit Breakers + 1 GFCI Sensor Module), 120/240V with Switched Neutral.
Termination	Circuit Breaker Line Side: #10-32 GFCI Sensor Module Load Side: #10-32. Neutral pigtail provided with non-switched neutral units.
Mounting	Front Panel, #6-32 or M3 threaded inserts.
Actuator	Handle, Flat Rocker, Curved Rocker (with or without rocker guard), Push-to-Reset Rocker
Internal Configuration	Circuit Breaker, Series Trip Switch only (without over-current protection)
Weight	1-pole: approximately 300 grams (10.6 ounces) 2-pole: approximately 375 grams (13.2 ounces) 3-pole: approximately 500 grams (17.6 ounces)
Standard Colors	Housing – Black, Test Button – White, Text – White

**Environmental**

Designed and tested in accordance with requirements of specification MIL-PRF- 55629 and MIL-STD-202G as follows:	
Shock	Withstands 100 G, 6ms, sawtooth at rated current per Method 213, Test Condition "I".
Thermal Shock	Method 107D, Condition A (5-cycle at -55°C to +25°C to +85°C to +25°C)
Vibration	Withstands 0.06" excursion from 10-55 Hz, and 10 G 55-500 Hz, at rated current per Method 204C, Test Condition A. Instantaneous & ultrashort curves tested at 90% of rated current.
Moisture Resistance	93% RH at 30°C for 168 Hours.
Operating Temperature	-35°C to +66°C
Corrosion	UL-943-6.21, 3 weeks Humidity: 30±2°C, 70±2% relative humidity Mixed Flowing Gases: 100 ppb H <sub>2</sub> S, 20 ppb Cl <sub>2</sub> , 200±50 ppb NO <sub>2</sub>

## GFCI LED Indication

Condition	Breaker	LED Output
Power with Open Circuit	Open	None
Circuit Manually Opened	Open	None
Power with Closed Circuit	Closed	Green (solid)
Ground Fault Leakage	Trips Open	Red (solid)
Grounded Neutral	Trips Open	Red (solid)
Passed Automatic, Self-Test	Closed	Red (flash lasting 2 ms, every 3 seconds)
Failed Automatic, Self-Test	Trips Open	Red (continuous flashing, every 0.10 seconds)
Manual GFCI Monthly Test	Trips Open	Red (solid)
Over Current	Trips Open	None
End of Life	Trips Open	Red (continuous flashing, every 0.10 seconds)

Loss of line power results in no LED output and no continuous trip

## GFCI Test Instructions

1. Turn "OFF" the GFCI Breaker actuator. Turn on the power to the panel. The green and red LED's should be off.
2. Turn "ON" the GFCI Breaker actuator. The green "POWER" LED should show steady illumination and the red "LEAKAGE FAULT" LED should flash every 3 seconds to indicate a successful self-test.
3. Depress the "TEST" button. This will cause the actuator to move to the "OFF" position and the red LED to turn on and show steady illumination, indicating that the GFCI is functioning properly. The green LED will also go from steady to off. If the actuator fails to move to the "OFF" position or the red LED fails to illuminate, the unit MUST be replaced.
4. Turn the GFCI Breaker actuator to the "ON" position. The red LED should flash every 3 seconds and the green LED should show steady illumination.
5. This test is to be performed on a monthly basis and recorded on the "Monthly Test Reminder" label.

## ELCI LED Indication

Indicator - Two integrated LEDs, Red & Green

- Green LED On, Red LED Off - Line Voltage is present, the breaker is closed, and the device is protecting the circuits against over current and leakage current.
- Green LED Off, Red LED On - The device has detected leakage current and has opened the circuit breaker.
- Green LED Flashing, Red LED Off - The circuit breaker has opened due to over current or has been turned off manually
- Green LED Off, Red LED Off - Line Voltage is not present
- Green LED Flashing, Red LED Off, Amber LED ON - Indicates Hot & Neutral are reversed and the circuit breaker is open

Neutral Protection - When neutral is grounded on load side of circuit

Test Button - Located on Ground Fault Module

**PC - B - B - A - 24 - 620 - 1 - B - A - A - 10**

1 Series      2 System Voltage/Poles      3 Circuit      4 Actuator      5 Frequency & Delay      6 Current Rating      7 Terminal      8 Actuator Color      9 Mounting/Barriers      10 Trip Level      11 Agency Approval

**1 SERIES**  
PC

**2 SYSTEM VOLTAGE / POLES 4**

- A** 120 VAC single phase, 1 pole
- B** 120/240 VAC single phase, 2 pole
- C** 120/240 VAC single phase with switched neutral, 3 pole
- D** 120 VAC single phase with switched neutral, 2 pole
- G** 240 VAC single phase, 2 pole

**3 CIRCUIT**

- B** Series Trip (Current)

**4 ACTUATOR**

**Handle**

- A** 1 per breaker pole
- B** 1 per unit

**Two Color Curved Visi-Rocker**

- C** Indicate ON, vertical legend
- D** Indicate ON, horizontal legend

- F** Indicate OFF, vertical legend
- G** Indicate OFF, horizontal legend

**Single Color Curved Rocker**

- J** Vertical legend
- K** Horizontal legend

**Two Color Curved Visi-Rocker**

**Push-to-Reset**

- N** Indicate OFF, Vertical legend
- O** Indicate OFF, Horizontal legend

**Single Color Curved Rocker Push-to-Reset**

- R** Vertical legend
- U** Horizontal legend

**Two Color Flat Visi-Rocker**

- 1** Indicate OFF, vertical legend
- 2** Indicate OFF, horizontal legend

**Single Color Flat Rocker**

- 3** Vertical legend
- 4** Horizontal legend

**Two Color Flat Visi-Rocker Push-to-Reset**

- 5** Indicate OFF, vertical legend
- 6** Indicate OFF, horizontal legend

**Single Color Flat Rocker Push-to-Reset**

- 7** Vertical legend
- 8** Horizontal legend

**ROCKER STYLE DESCRIPTIONS**

	INDICATE "ON"	INDICATE "OFF"	SINGLE COLOR	INDICATE "OFF"	SINGLE COLOR
VERTICAL STYLE	LINE CODE "C", "N"	LINE CODE "F", "N"	LINE CODE "J", "R"	LINE INDICATE COLOR LOCATION CODE "1", "5"	LINE CODE "3", "7"
	LINE INDICATE COLOR LOCATION CODE "D"	LINE CODE "G", "O"	LINE CODE "K", "U"	LINE CODE "2", "6"	LINE CODE "4", "8"
HORIZONTAL STYLE	LINE CODE "C", "N"	LINE CODE "F", "N"	LINE CODE "J", "R"	LINE CODE "1", "5"	LINE CODE "3", "7"
	LINE CODE "D"	LINE CODE "G", "O"	LINE CODE "K", "U"	LINE CODE "2", "6"	LINE CODE "4", "8"

**5 FREQUENCY & DELAY**

- 20** 50 / 60Hz Instantaneous
- 21** 50 / 60Hz Ultra Short
- 22** 50 / 60Hz Short
- 24** 50 / 60Hz Medium
- 26** 50 / 60Hz Long

**6 CURRENT RATING (AMPERES)**

CODE	AMPERES	CODE	AMPERES	CODE	AMPERES	CODE	AMPERES
410	1.000	445	4.500	610	10.000	618	18.000
512	1.250	450	5.000	710	10.500	620	20.000
415	1.500	455	5.500	611	11.000	622	22.000
517	1.750	460	6.000	711	11.500	624	24.000
420	2.000	465	6.500	612	12.000	625	25.000
522	2.250	470	7.000	712	12.500	630	30.000
425	2.500	475	7.500	613	13.000	635	35.000
527	2.750	480	8.000	614	14.000	640	40.000
430	3.000	485	8.500	615	15.000	650	50.000
435	3.500	490	9.000	616	16.000		
440	4.000	495	9.500	617	17.000		

**7 TERMINAL**

- 1** Stud, 10-32 threaded

**8 ACTUATOR COLOR & LEGEND**

**Handle**

Actuator Color	I-O	ON-OFF	Dual	Single	Rocker Actuator Color	Visi-Rocker
White	A	B	1	Black	White	White
Black	C	D	2	White	N/A	N/A
Red	F	G	3	White	Red	Red
Green	H	J	4	White	Green	Green
Blue	K	L	5	White	Blue	Blue
Yellow	M	N	6	Black	Yellow	Yellow
Gray	P	Q	7	Black	Gray	Gray
Orange	R	S	8	Black	Orange	Orange

**9 MOUNTING / BARRIERS**

Actuator Color	MOUNTING STYLE	BARRIERS
<b>A</b>	6-32 X 0.195 inches Threaded Insert, 2 per pole	yes
	ISO M3 x 5mm	yes
<b>C</b>	Rockerguard Bezel Threaded Insert, 2 per pole	
	6-32 X 0.195 inches	yes
<b>D</b>	ISO M3 x 5mm	yes
	Standard Bezel with Recessed Off-Side Flat Rocker Threaded Insert, 2 per pole	
<b>E</b>	6-32 X 0.195 inches	yes
	ISO M3 x 5mm	yes
<b>G</b>	Push-to-Reset Bezel Threaded Insert, 2 per pole	
	6-32 X 0.195 inches	yes
<b>H</b>	ISO M3 x 5mm	yes

**10 LEAKAGE CURRENT TRIP LEVEL - MAX. TRIP CURRENT**

- A** 6 MA (CLASS A GFCI) <sup>2</sup>
- E** 30 MA (ELCI) <sup>1,3</sup>

**11 AGENCY APPROVAL**

- AA** without Approvals
- 10** UL 943 and CSA certified <sup>2</sup>
- 11** UL 1053 <sup>1,3</sup>
- 12** UL 1053 & UL 1500 <sup>1,3</sup>

Notes:

- 1 This device meets the requirements of ABCY E11.
- 2 6mA per UL943, available with agency code 10.
- 3 30mA per UL1053, available with agency approval codes 11 & 12.
- 4 Agency approval code 10 only available with system voltages A, B, C and D.

## Dimensional Specifications: in. [mm]

INDICATE OFF / SINGLE COLOR  
ROCKER ACTUATOR

HANDLE / INDICATE ON  
ROCKER ACTUATOR

TERMINAL  
LOCATIONS

PCA  
120 VAC  
VERSION

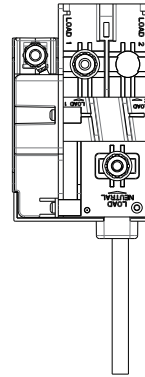
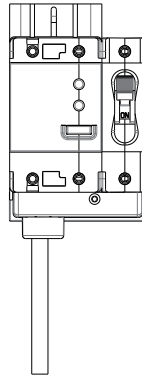
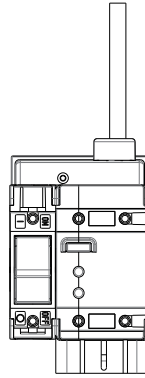

PCB  
120/240 VAC  
VERSION

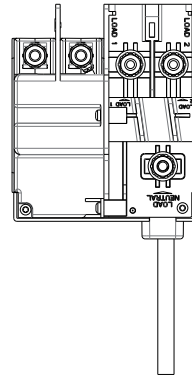
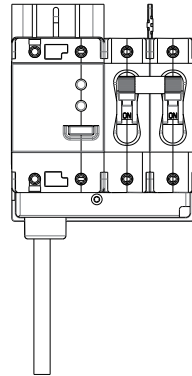
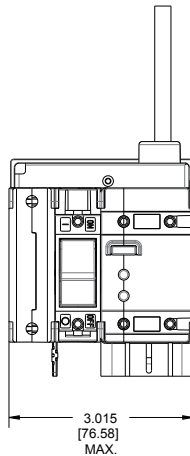

PCC  
120/240 VAC  
VERSION  
W/ NEUTRAL BREAK

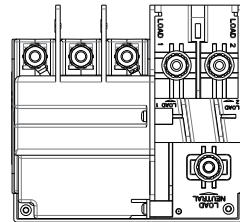
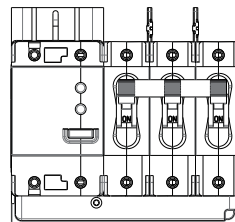
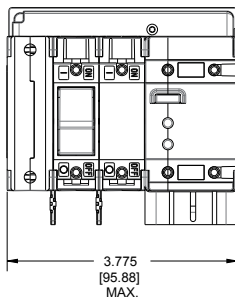

PCD  
120 VAC  
VERSION  
W/NEUTRAL BREAK

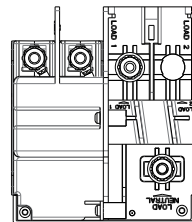
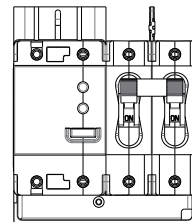
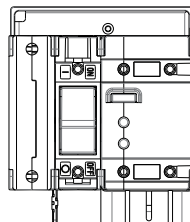



## Dimensional Specifications: in. [mm]

NOTE: NEUTRAL - SUPPLIED 12" LONG MIN. (CIRCUIT CODES A,B,E & F)

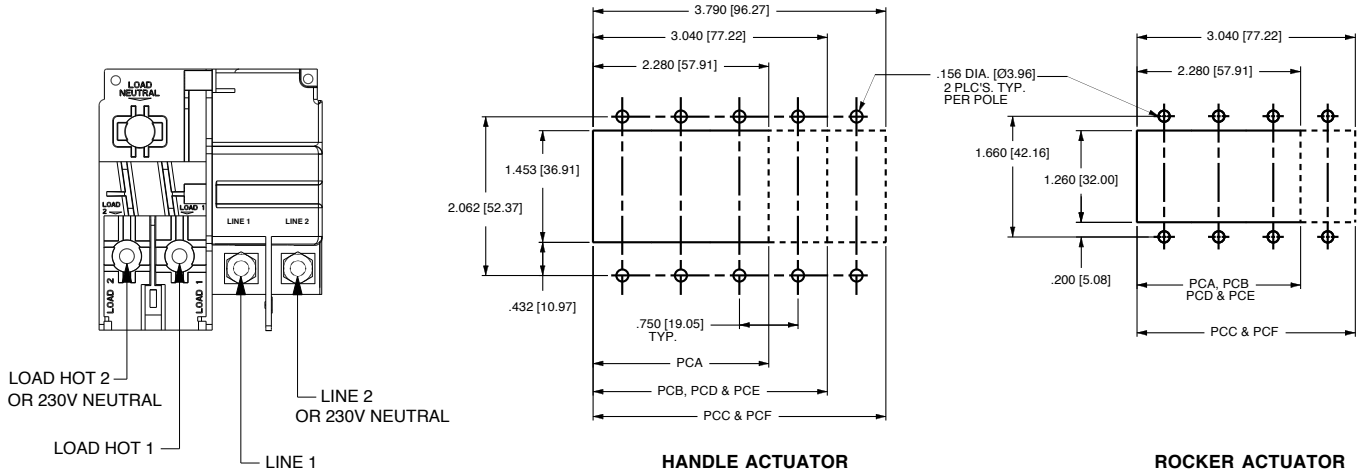

PANEL CUTOUT DETAIL  
TOLERANCES ±.005 [12]

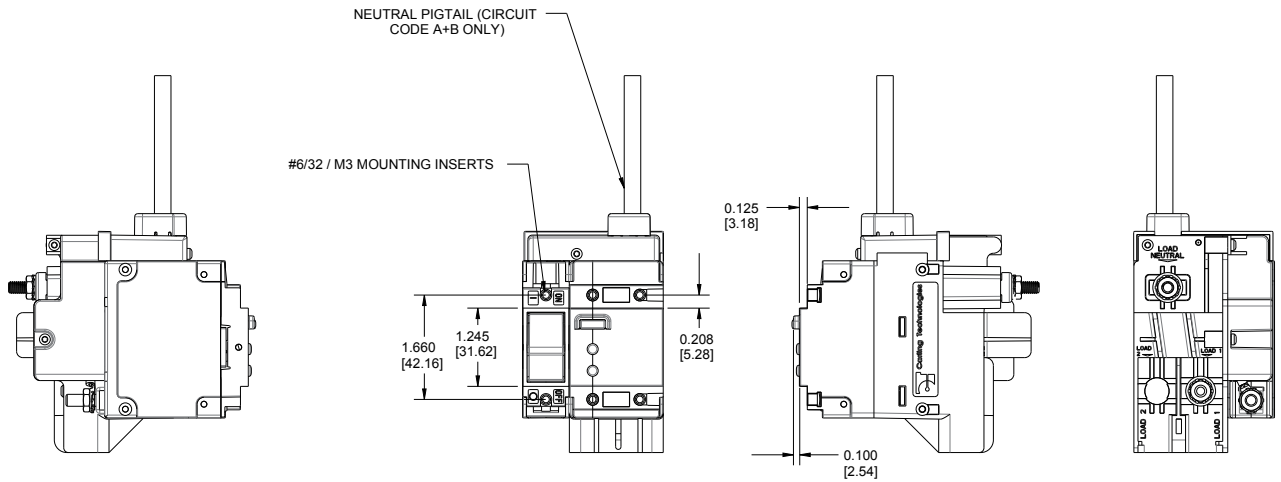
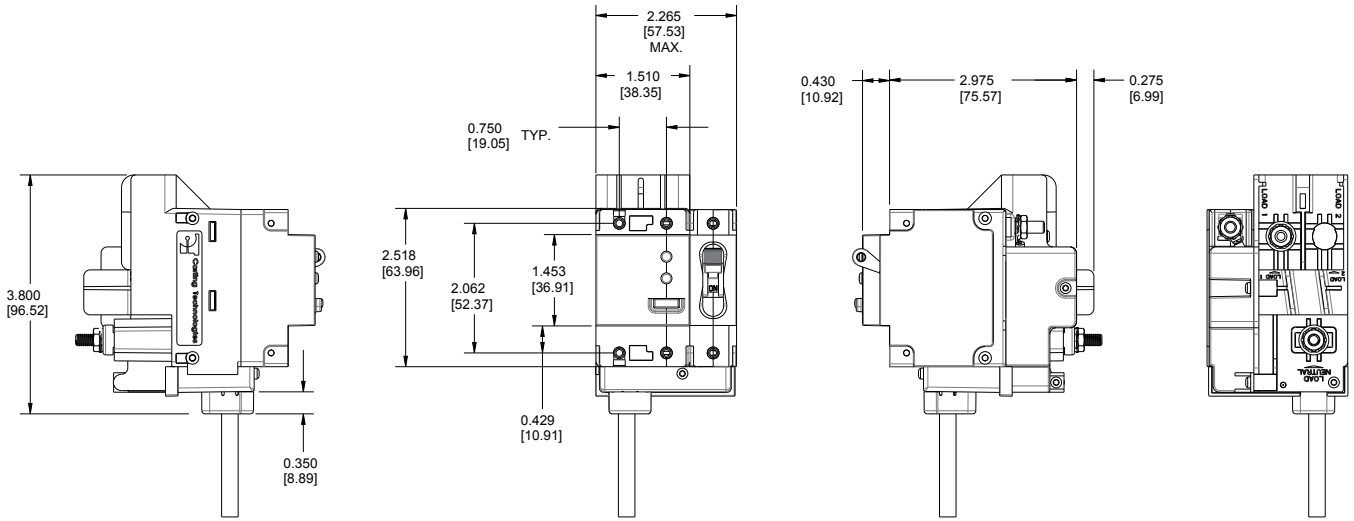

Notes:  
For additional circuit breaker dimensions, reference the C-Series Breakers in the Carling Circuit Protection catalog



**8** **PC** - **1** **4** **1**

<sup>1</sup> Type Number    <sup>2</sup> Series    <sup>3</sup> Actuator    <sup>4</sup> Poles    <sup>5</sup> Mounting

**1 TYPE NUMBER**

**8** Circuit Breaker Assembly

**2 SERIES**

**PC**

**3 ACTUATOR TYPE**

**1** Handle, one per pole  
**2** Handle, one per multipole unit  
**A** Rocker

**4 POLES PER UNIT - INCLUDING ELECTRONIC MODULE**

**3** Three  
**4** Four  
**5** Five

**5 MOUNTING SCREWS / PLATE MATERIAL <sup>1</sup>**

**1** 6-32 Thread Phillips Head  
**2** M-3 Thread Phillips Head  
**3** 6-32 Thread Slotted Head  
**4** M-3 Thread Slotted Head  
**5** 6-32 Thread Phillips Head with Stainless Steel Plate  
**6** M-3 Thread Phillips Head with Stainless Steel Plate  
**7** 6-32 Thread Slotted Head with Stainless Steel Plate  
**8** M-3 Thread Slotted Head with Stainless Steel Plate

**Notes:**

**1** Screws supplied to accommodate mounting panel thickness of 1/8" ± 1/32". Consult Factory for additional options  
**2** Available for Flat and Curved Rocker options - No Rockerguard Bracket

**Handle Style Panel Seal**

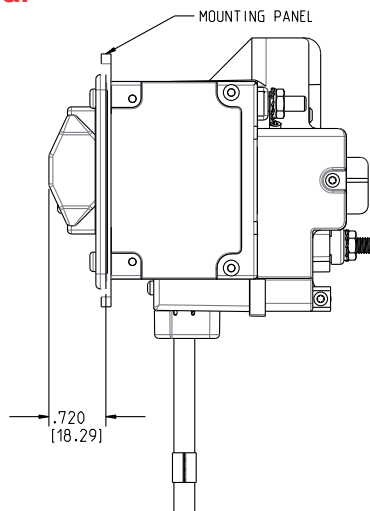
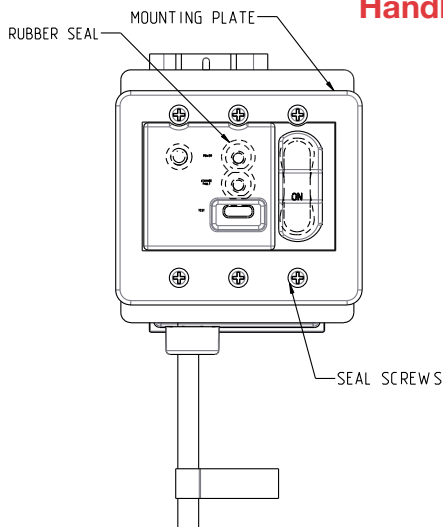

**Rocker Style Panel Seal**

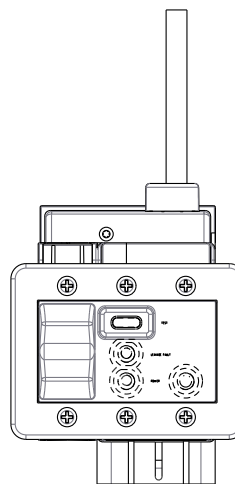
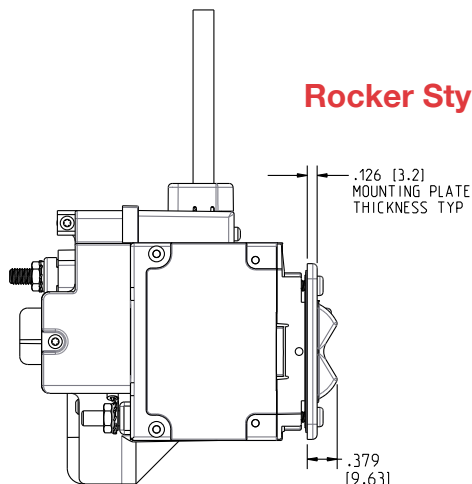

### Handle Actuator



### Rocker Actuator



## Time Delay Curves Instantaneous

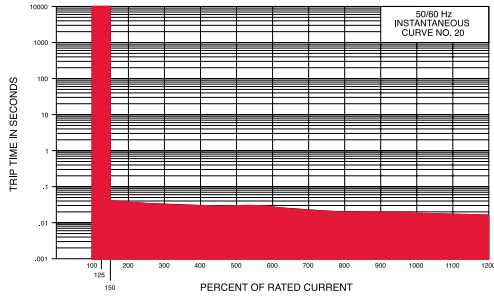

## Medium

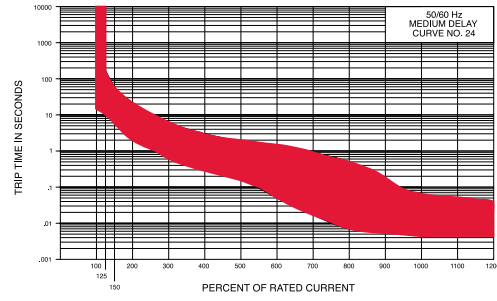

## Ultra Short

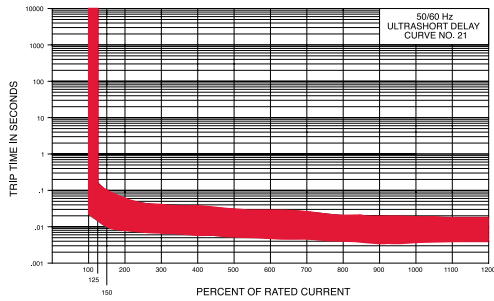

## Long

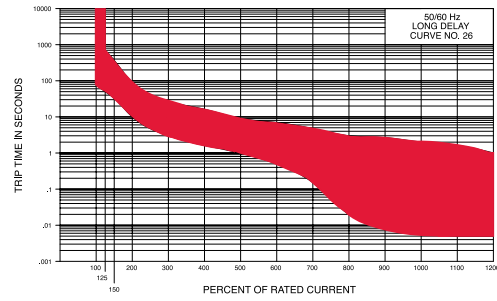

## Short

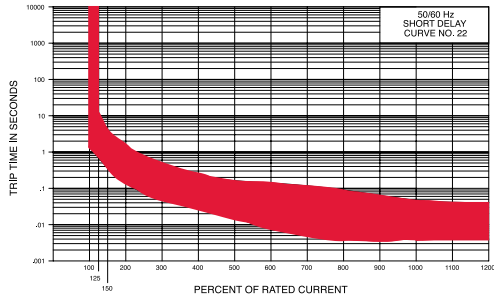

Time Delay Values									
Percent of Rated Current									
Delay	100%	125%	150%	200%	400%	600%	800%	1000%	1200%
<b>20</b>	No Trip	May Trip	.040 MAX	.035 MAX	.030 MAX	.025 MAX	.020 MAX	.017 MAX	.015 MAX
<b>21</b>	No Trip	.014 - .150	.011 - .095	.008 - .055	.006 - .035	.005 - .027	.005 - .021	.004 - .018	.004 - .017
<b>22</b>	No Trip	.700 - 12.0	.350 - 4.00	.130 - 1.30	.027 - .220	.008 - .130	.004 - .090	.004 - .045	.004 - .040
<b>24</b>	No Trip	10.0 - 160	6.00 - 60.0	2.20 - 20.0	.300 - 3.00	.050 - 1.30	.007 - .500	.005 - .060	.005 - .040
<b>26</b>	No Trip	50.0 - 700	32.0 - 350	10.0 - 90.0	1.50 - 15.0	.500 - 7.00	.020 - 3.00	.006 - 2.00	.005 - 1.00

**Notes:**

Other time delay values available, consult factory.

Delay Curves 21,22,24,26: Breakers to hold 100% and must trip at 125% of rated current and greater within the time limit shown in this curve.

Delay Curve 20: Breakers to hold 100% and must trip at 150% of rated current and greater within the time limit shown in this curve.

All Curves: Curve data shown represents breaker response at ambient temperature of 77°F (25°C) with no preloading. Breakers are mounted in standard wall-mount position.

The minimum inrush pulse tolerance handling capability is 12 times the rated current. These values are based on a 60 Hz 1/2 cycle, 8.33 ms pulse.

## Authorized Sales Representatives and Distributors

Click on a region of the map below to find your local representatives and distributors or visit [www.carlingtech.com/findarep](http://www.carlingtech.com/findarep).



## About Carling

Founded in 1920, Carling Technologies is a leading manufacturer of electrical and electronic switches and assemblies, circuit breakers, electronic controls, power distribution units, and multiplexed power distribution systems. With four ISO registered manufacturing facilities and technical sales offices worldwide, Carling Technologies Sales, Service and Engineering teams do much more than manufacture electrical components, they engineer powerful solutions! To learn more about Carling please visit [www.carlingtech.com/company-profile](http://www.carlingtech.com/company-profile).

To view all of Carling's environmental, quality, health & safety certifications please visit [www.carlingtech.com/environmental-certifications](http://www.carlingtech.com/environmental-certifications)



### **Worldwide Headquarters**

Carling Technologies, Inc.  
60 Johnson Avenue, Plainville, CT 06062  
**Phone:** 860.793.9281 **Fax:** 860.793.9231  
**Email:** sales@carlingtech.com

**Northern Region Sales Office:** nrsm@carlingtech.com  
**Southeast Region Sales Office:** sersm@carlingtech.com  
**Midwest Region Sales Office:** mrsm@carlingtech.com  
**West Region Sales Office:** wrsm@carlingtech.com  
**Latin America Sales Office:** larsm@carlingtech.com

### **Asia-Pacific Headquarters**

Carling Technologies, Asia-Pacific Ltd.,  
Suite 1607, 16/F Tower 2, The Gateway,  
Harbour City, 25 Canton Road,  
Tsimshatsui, Kowloon, Hong Kong  
**Phone:** Int + 852-2737-2277 **Fax:** Int + 852-2736-9332  
**Email:** sales@carlingtech.com.hk

**Shenzhen, China:** shenzhen@carlingtech.com  
**Shanghai, China:** shanghai@carlingtech.com  
**Pune, India:** india@carlingtech.com  
**Kaohsiung, Taiwan:** taiwan@carlingtech.com  
**Yokohama, Japan:** japan@carlingtech.com

### **Europe | Middle East | Africa Headquarters**

Carling Technologies LTD  
4 Airport Business Park, Exeter Airport,  
Clyst Honiton, Exeter, Devon, EX5 2UL, UK  
**Phone:** Int + 44 1392.364422 **Fax:** Int + 44 1392.364477  
**Email:** ltd.sales@carlingtech.com

**Germany:** gmbh@carlingtech.com  
**France:** sas@carlingtech.com



**Carling Technologies®**

Innovative Designs. Powerful Solutions.