

Description	Material	Finish
Body	Brass	Nickel
Socket	Brass	Gold
Insulation	PTFE	N/A
Washer	Brass	Nickel
Nut	Brass	Nickel

REVISIONS			
REV	DESCRIPTION	DATE	APPV
B	Added Nut and Washer	2/18/10	CJ
C	Updated footprint and dimensions; Added new title block	2-JUL-12	SAH

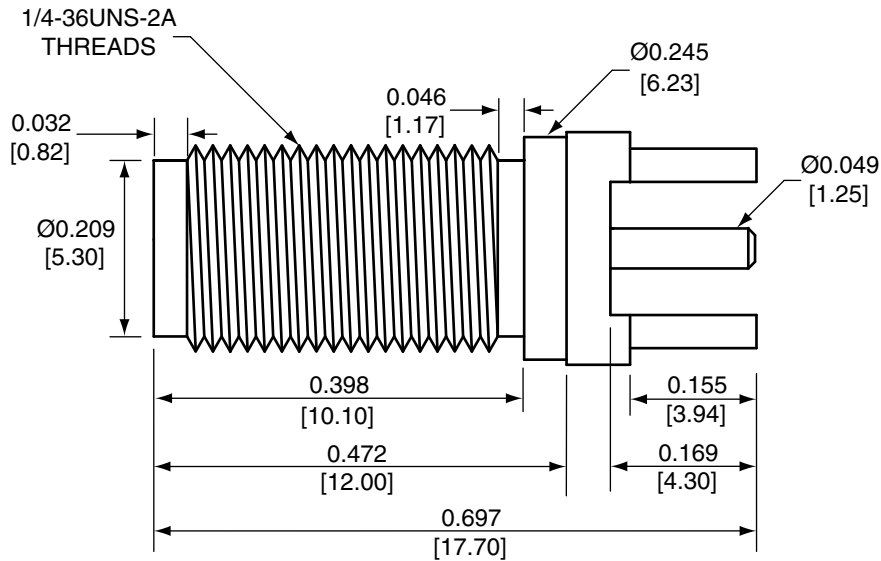

SIDE VIEW

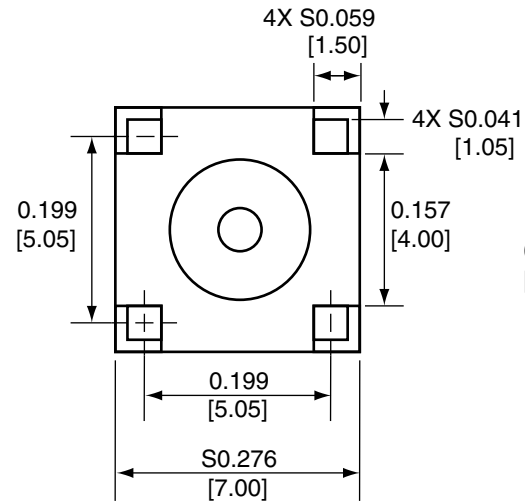

BACK VIEW

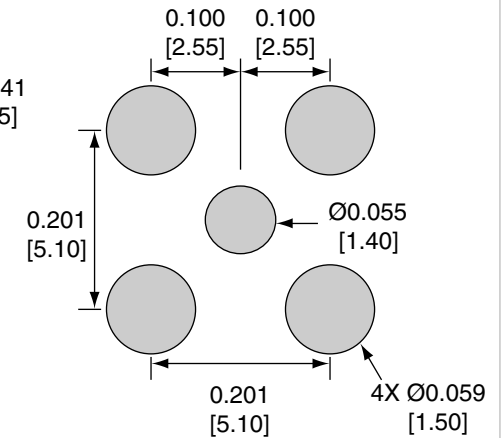

RECOMMENDED FOOTPRINT

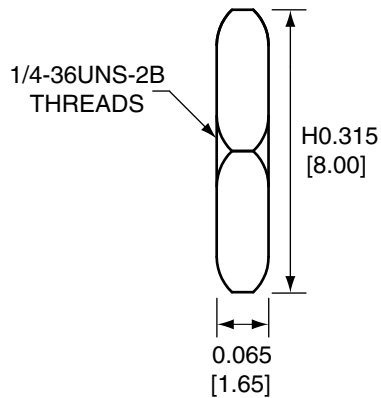

NUT

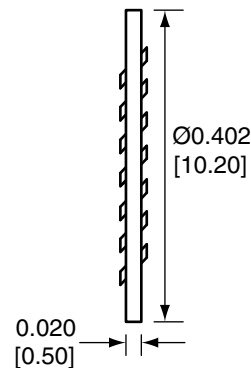



WASHER

NOTES: (UNLESS OTHERWISE SPECIFIED)

1. ALL DIMENSIONS ARE IN INCHES [mm].
2. DIMENSIONS APPLY AFTER FINISHING.
3. MANUFACTURE TO BE COMPLIANT WITH EU RoHS DIRECTIVE.
4. SAFETY BREAK ALL SHARP CORNERS AND EDGES .02 MAXIMUM.

WARNING: THIS DRAWING CONTAINS PROPRIETARY INFORMATION THAT IS THE SOLE PROPERTY OF LINX TECHNOLOGIES, AND SHALL BE TREATED AS SUCH. NO DISCLOSURE OR REPRODUCTION OF THIS DOCUMENT IS PERMITTED, IN WHOLE OR IN PART, WITHOUT THE EXPRESS WRITTEN PERMISSION OF LINX TECHNOLOGIES OR ITS DESIGNATED AGENTS.

MATERIAL:	TOLERANCES: .020 [0.50]-.200 [5.00]= ±.008 [0.20] .200 [5.00]-1.200 [30.00]= ±.016 [0.40] 1.20 [30.0]-4.75 [120.0]= ±.024 [0.60] 4.75 [120.0]-12.40 [315.0]= ±.040 [1.0]	PROJECTION:  ANGLES: ±1°
FINISH:	DRAWN: B.MURPHY	DT: 2-JUL-12
	ENGR: S.HOGAN	DT: 2-JUL-12

		159 ORT LANE MERLIN, OR 97532	
TITLE: SMA FEMALE PCB MOUNT EXTENDED			
SIZE A	DWG. NO. CON SMA008	REV C	
SCALE: 2:1	DO NOT SCALE DRAWING	SHEET 1 OF 1	