

The TGM-NA and TDM-NA, reinforced insulation, 6 pin transformers provide the isolation and voltage outputs required for low cost DC/DC converter circuits. UL1950, IEC950 and EN60950 recognized. Designed specifically for use with the Maxim™ MAX253 and MAX845 monolithic oscillator/power drivers with 3.3V or 5V power source. Other packages are available with isolation voltages ranging from 500 to 4.5KVrms. For more information, pertaining to the MAX845 please contact Maxim at (408) 737-7600. Maxim is a registered trademark of Maxim Integrated Products.



TGM-NA SMD Package



TDM-NA DIL Package

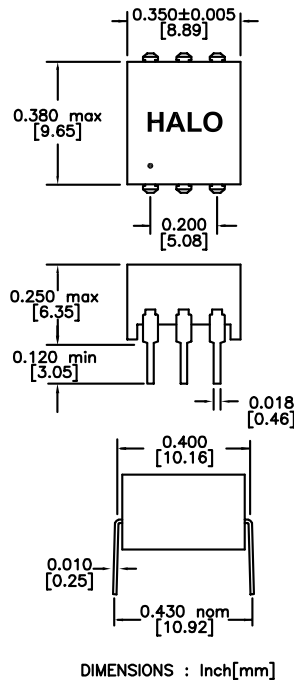

Circuit Diagram



Electrical Specifications @ 25°C
 Operating Temp: -40 to +85°C
 Pri Pins: 1-3
 Pri OCL: 960µH typ
 Pri DCR: 0.8Ω

Patented Construction
 US Pat Nbrs: 5,656,985

SMD	Part Number	Turns Ratio (±3%)	ET Constant	Isolation
	DIL	PRI:SEC	V-us min.	Vrms
TGM-310NA	TDM-310NA	2CT:1CT	18	3,000
TGM-320NA	TDM-320NA	8CT:3CT	18	3,000
TGM-330NA	TDM-330NA	4CT:3CT	18	3,000
TGM-340NA	TDM-340NA	3CT:4CT	18	3,000
TGM-350NA	TDM-350NA	1CT:1CT	18	3,000
TGM-360NA	TDM-360NA	1CT:2CT	22	3,000
TGM-380NA	TDM-380NA	3CT:8CT	22	3,000

The TGM-NA and TDM-NA, reinforced insulation, 6 pin transformers provide the isolation and voltage outputs required for low cost DC/DC converter circuits. UL1950, IEC950 and EN60950 recognized. Designed specifically for use with the Maxim™ MAX253 and MAX845 monolithic oscillator/power drivers with 3.3V or 5V power source. Other packages are available with isolation voltages ranging from 500 to 4.5KVrms. For more information, pertaining to the MAX845 please contact Maxim at (408) 737-7600. Maxim is a registered trademark of Maxim Integrated Products.



TGM-NA SMD Package

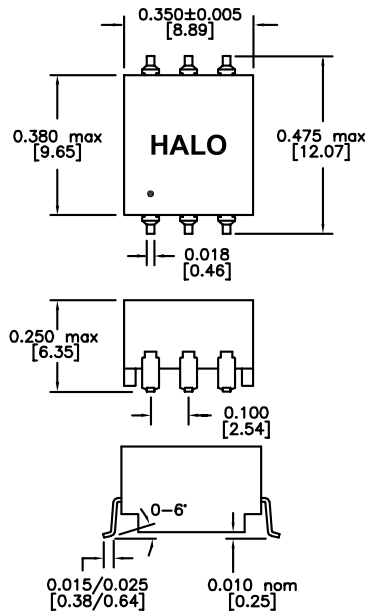

DIMENSIONS: Inch[mm]
CO-PLANARITY: 0.004[0.10]

Circuit Diagram

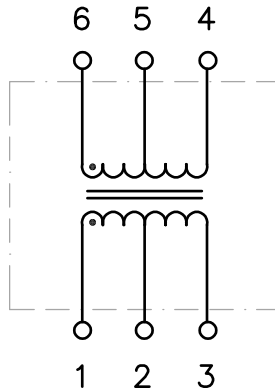

Electrical Specifications @ 25°C

Operating Temp: -40 to +85°C
Pri Pins: 1-3
Pri OCL: 500μH typ
Pri DCR: 0.8Ω

Patented Construction
US Pat Nbrs: 5,656,985

Part Number	Turns Ratio (±3%)	ET Constant	Isolation
SMD	PRI:SEC	V-us min.	Vrms
TGM-310NARL	2CT:1CT	11	3,000
TGM-320NARL	8CT:3CT	11	3,000
TGM-330NARL	4CT:3CT	11	3,000
TGM-340NARL	3CT:4CT	11	3,000
TGM-350NARL	1CT:1CT	11	3,000
TGM-360NARL	1CT:2CT	11	3,000
TGM-380NARL	3CT:8CT	11	3,000

The TGM-NF, reinforced insulation, 8 pin transformers provide the isolation and voltage outputs required for low cost DC/DC converter circuits. UL1950, IEC950 and EN60950 recognized. Designed specifically for use with the Maxim™ MAX253 and MAX845 monolithic oscillator/power drivers with 3.3V or 5V power source. Smaller packages are available for lower isolation voltage applications. For more information, pertaining to the MAX845 please contact Maxim at (408) 737-7600. Maxim is a registered trademark of Maxim Integrated Products.



NF Package



Circuit Diagram



Electrical Specifications @ 25°C

Operating Temp: -40 to +85°C
Pri DCR: 0.8Ω
Pri OCL (1-4, tie 2-3): 500μH typ

Patented Construction
US Pat Nbrs: 5,656,985

Part Number	Turns Ratio (±3%)	ET Constant	Isolation
	PRI:SEC	V _{μs} Min	Vrms
TGM-410NF	2CT:1CT	18	4,500
TGM-420NF	8CT:3CT	18	4,500
TGM-430NF	4CT:3CT	18	4,500
TGM-440NF	3CT:4CT	18	4,500
TGM-450NF	1CT:1CT	18	4,500

The TGM-NF, reinforced insulation, 8 pin transformers provide the isolation and voltage outputs required for low cost DC/DC converter circuits. UL1950, IEC950 and EN60950 recognized. Designed specifically for use with the Maxim™ MAX253 and MAX845 monolithic oscillator/power drivers with 3.3V or 5V power source. Smaller packages are available for lower isolation voltage applications. For more information, pertaining to the MAX845 please contact Maxim at (408) 737-7600. Maxim is a registered trademark of Maxim Integrated Products.



NF Package



Circuit Diagram



Electrical Specifications @ 25°C
 Operating Temp: -40 to +85°C
 Pri DCR: 0.8Ω
 Pri OCL (1-4, tie 2-3): 500μH typ

Patented Construction
 US Pat Number: 5,656,985

Part Number	Turns Ratio (±3%) PRI:SEC	ET Constant Vμs Min	Isolation Vrms
TGM-410NFRL	2CT:1CT	11	4,500
TGM-420NFRL	8CT:3CT	11	4,500
TGM-430NFRL	4CT:3CT	11	4,500
TGM-440NFRL	3CT:4CT	11	4,500
TGM-450NFRL	1CT:1CT	11	4,500

The TDM and TGM series of transformers have been designed specifically for use with the Maxim™ MAX253 and MAX845 monolithic oscillator/power driver with 3.3V or 5V power source. Multiple output voltages can be achieved depending on the diode circuit and transformer selected. For more information, pertaining to the MAX253/MAX845 please contact Maxim at (408) 737-7600. Maxim is a registered trademark of Maxim Integrated Products.

Bridge Rectifier Circuit



*Switching freq. 450KHz min.

Output Voltages

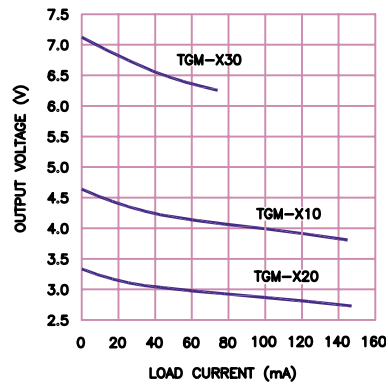

Doubler Circuit

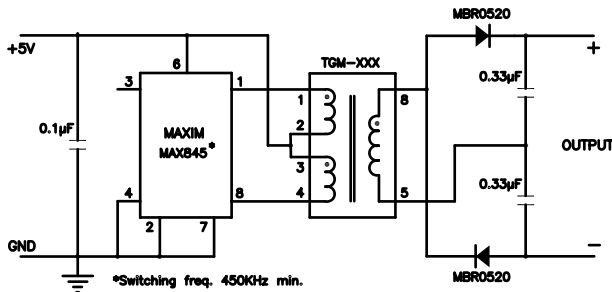

*Switching freq. 450KHz min.

Output Voltages

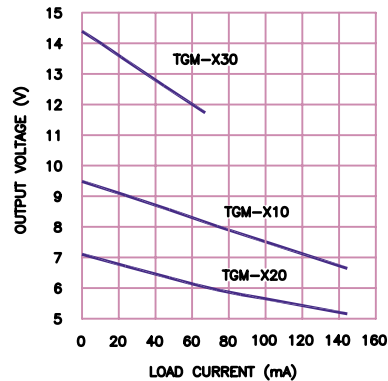

Full Wave Rectifier Circuit

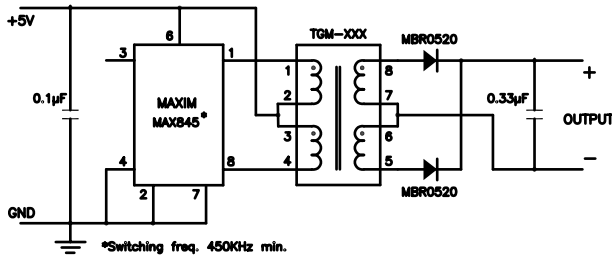

*Switching freq. 450KHz min.

Output Voltages

