

μCom-10Gb +

Harsh Environment 10Gb
Ethernet Micro Connectors



μCom-Series is a new range of connectors designed to address the latest trends of the industry : **miniaturization** and **high speed**, with the highest resistance for use in the **harshest environments**.

μCom-10Gb + is the first product of this new range.

MAIN FEATURES

- 10Gb+ exceeds 10Gb/s Ethernet following IEEE 802.3an-2006 : **10GBase-T**
- Cat.6A connector according to TIA568C.2 and ISO/IEC11801 standard
- Environmental testing based on **MIL-DTL-38999 series III** military specifications (Thread version)
- Environmental testing based on **MIL-DTL-26482** military specifications (Push Pull version)
- Miniature : **15 mm(.59") max** external diameter
- Receptacle and in-line receptacle compatible with both thread and Push Pull plugs

FEATURES AND BENEFITS

- 4 pairs totally insulated throughout the connector
 - ➔ minimum cross-talk between the four pairs
- Patent pending special interfacial shapes
 - ➔ minimum perturbation at the interface of each pair
- Thread coupling mechanism
 - ➔ 2000 mating cycles & high vibration resistance
- Machined Brass shells
 - ➔ Plating available:
 - Olive Drab Cadmium → not ROHS compliant
 - Black Nickel, and unplated brass → ROHS compliant
 - ➔ shell to shell continuity and 500h salt spray resistance
- Machined & gold plated Solder and Crimp contacts
 - ➔ design & performance according to the innercontact of M39029/77-429#16 M39029/76-425#16 38999 contact
- Solder contact : max AWG24
- Crimp contact : AWG 24 to 26
- IP68 sealing mated and unmated for PCB receptacles
- 1500 Vrms Dielectric Withstanding voltage
- Temperature range : - 55°C / + 125°C

MARKETS & APPLICATIONS

- **DEFENSE** : C4ISR, Battlefield Communications, Shipboard, Ground Vehicles Vetronics.
- **AERONAUTICAL** : In Flight Entertainment, Avionics, Communication Systems.
- **RAIL MASS TRANSIT** : Passenger Information Systems, Communication Systems.



TRANSMISSION DATA

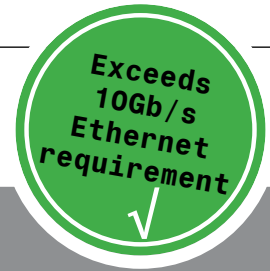

Insertion loss



← Amphenol performance

← IEEE 802.3an Standard requirement

Next 1-2



← IEEE 802.3an Standard requirement

← Amphenol performance

Return loss

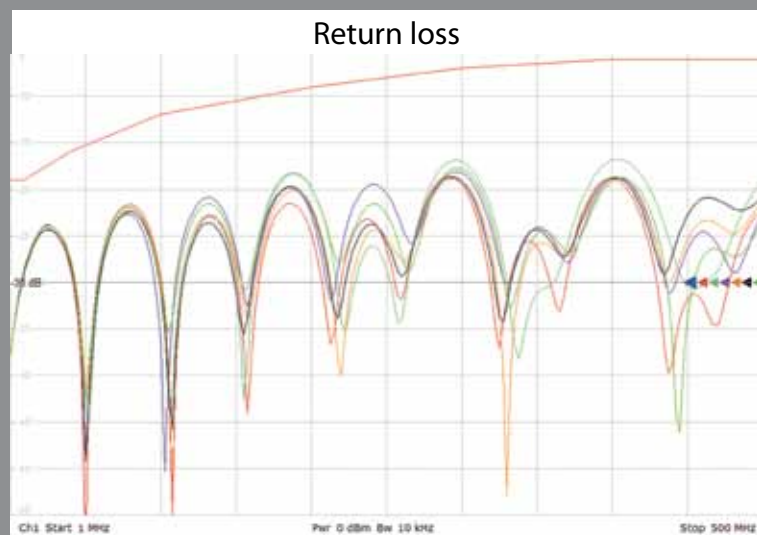

← IEEE 802.3an Standard requirement

← Amphenol performance

FEMALE RECEPTACLES



Female receptacle for printed circuit board

Compatible with both thread & push pull plugs

Part number: UCOM-10G+ R P X

X: see the 'How to order' below to complete your part number

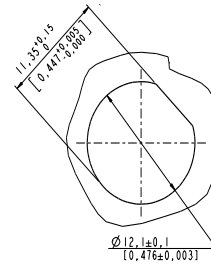
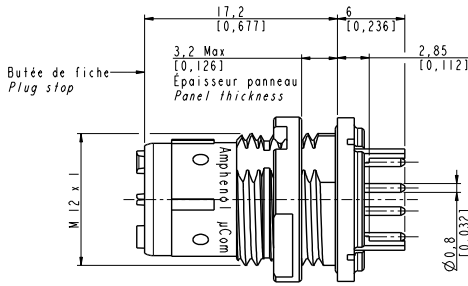

Panel mount female receptacle with metallic band backshell

Compatible with both thread & push pull plugs

Part number: UCOM-10G+ R X X

X: see the 'How to order' below to complete your part number

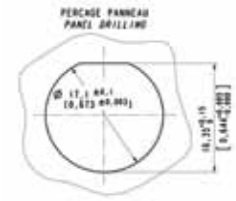

Nota: metallic band and heatshrink sleeve are provided with the connector

HOW TO ORDER Female receptacles

UCOM - 10G+ R P B

Shell

R: receptacle (push pull or thread)

Contacts termination

P: PCB

S: solder

C: crimp

Shell plating

B: black nickel

G: olive drab cadmium

U: unplated brass

NOTA:

- UCOM for order designation
- µCom for marking on connectors

MALE PLUGS



Plug with cable gland backshell

Part number: UCOM-10G+ PT x x G x
 x: see the 'How to order' below to complete your part number

Part number: UCOM-10G+ P P x x G x
 x: see the 'How to order' below to complete your part number

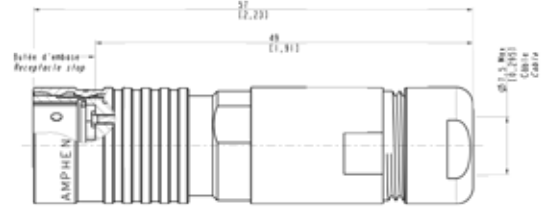
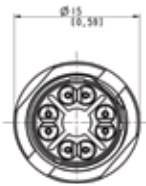

Plug with metallic band backshell

Part number: UCOM-10G+ PT x x B
 x: see the 'How to order' below to complete your part number

Part number: UCOM-10G+ P P x x B
 x: see the 'How to order' below to complete your part number

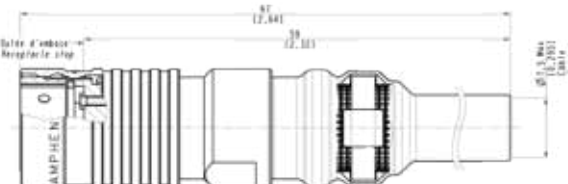
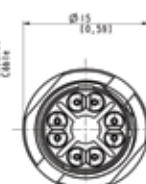
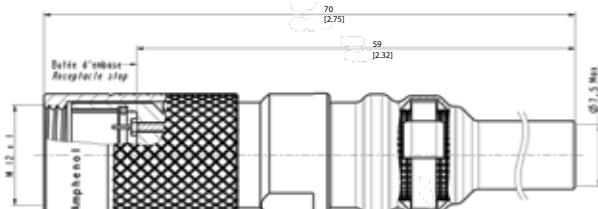

Nota: Metallic band and heatshrink sleeve are provided with the connector

HOW TO ORDER Male plugs

| | UCOM - 10G+ | P | T | C | B | G | A |
|---|-------------|---|---|---|---|---|---|
| Shell P: plug | | | | | | | |
| Mating (for plugs only) T: thread P: push-pull | | | | | | | |
| Contacts termination C: crimp S: solder | | | | | | | |
| Shell plating B: black nickel G: olive drab cadmium U: unplated brass | | | | | | | |
| Backshell type G: gland B: band | | | | | | | |
| Cable diameter (for gland backshell only) A: for cable diam 7.5mm B: to be defined | | | | | | | |

NOTA:

- UCOM for order designation
- μCom for marking on connectors

FEMALE IN-LINE RECEPTACLES



Female in-line receptacle with cable gland backshell

Compatible with both thread & push pull plugs

Part number: UCOM-10G+ L x x G x
 x: see the 'How to order' below to complete your part number



Female in-line receptacle with metallic band backshell

Compatible with both thread & push pull plugs

Part number: UCOM-10G+ L x x B
 x: see the 'How to order' below to complete your part number



Nota: Metallic band and heatshrink sleeve are provided with the connector

HOW TO ORDER Female in-line receptacles

| UCOM - 10G+ | L | S | B | G | A |
|--|---|---|---|---|---|
| Shell | | | | | |
| L: in line receptacle (push pull or thread) | | | | | |
| Contacts termination | | | | | |
| C: crimp | | | | | |
| S: solder | | | | | |
| Shell plating | | | | | |
| B: black nickel | | | | | |
| G: olive drab cadmium | | | | | |
| U: unplated brass | | | | | |
| Backshell type | | | | | |
| G: gland | | | | | |
| B: band | | | | | |
| Cable diameter (for gland backshell only) | | | | | |
| A: for cable diam 7.5mm | | | | | |
| B: to be defined | | | | | |

- NOTA:**
- UCOM for order designation
 - μCom for marking on connectors

CORDSETS



μCom plug - μCom plug cordset

Part number:
UCOM-10G+ C x x x xxx

x: see the 'How to order' on the next page to complete your part number



μCom plug - RJ45 Cat6A plug cordset

Part number:
UCOM-10G+ D x x x xxx

x: see the 'How to order' on the next page to complete your part number



μCom panel mount receptacle - RJ45 Cat6A plug

Part number:
UCOM-10G+ E x x xxx

x: see the 'How to order' on the next page to complete your part number



μCom plug - μCom inline receptacle

Part number:
UCOM-10G+ F x x x xxx

x: see the 'How to order' below to complete your part number

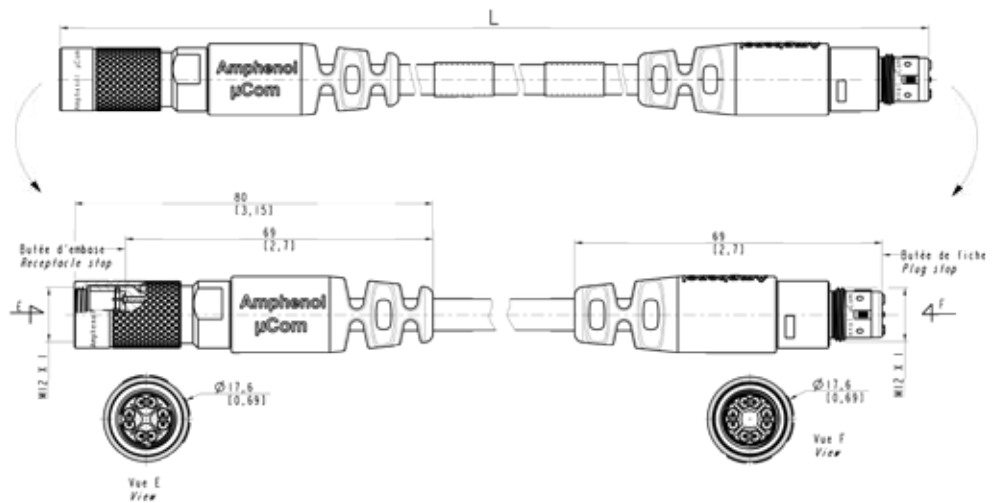

Type of cable used: CAT 7 HFFR - According to EN 50288-4-2



- Stranded bare copper wire (26 AWG)
- 4 screened twisted pairs: 2 wires twisted to a pair, Aluluminum foil overlapped
- Shield braiding of tinned copper wires, about 80% coverage
- Strain member of Kevlar
- Jacket in black Polyurethane (PUR), glossy finish, acc to DIN VDE 0282
- External diameter 7.0 +/-0.3 mm
- UV & Hydrolysis resistant, Halogen free, RoHS compliant
- Max Pull force: 800 N, Weight : about 54 kg/km
- Temperature : - 40°C / + 85°C
- Min. bending radius allowed: repeated 8 x Ø, single 4 x Ø

HOW TO ORDER Cordsets

UCOM - 10G+ C T C B 015

Shell

- C: μCom plug - μCom plug cordset
 - D: μCom plug - RJ45 Cat6A plug cordset
 - E: μCom panel mount receptacle - RJ45 Cat6A plug cordset
 - F: μCom plug - μCom inline receptacle cordset
- Open versions:
- G: μCom plug - no connector at the end
 - H: μCom panel mount receptacle - no connector at the end
 - J: μCom inline receptacle - no connector at the end

Mating (for plugs only)

T: thread

Contacts termination

- C: crimp
- S: solder

Shell plating

- B: black nickel
- G: olive drab cadmium
- U: unplated brass

Total length - For other lengths, please consult us.

- 002: 20 cm [7.87]
- 005: 50 cm [19.68]
- 010: 1.0 m [39.37]
- 015: 1.5 m [59.05]
- 020: 2.0 m [78.74]
- 050: 5.0 m [196.85]
- 100: 10.0 m [393.70]

NOTA:

- UCOM for order designation
- μCom for marking on connectors

ACCESSORIES

CAPS for receptacles

IP68 metallic cap

- x** to be replaced by
- B** for Black nickel plating
- G** for Olive drab cadmium plating
- U** for Unplated brass



IP68 metallic cap with metallic tie on panel Or IP68 metallic cap with a Ø12 fixation ring
Nota: plan a hole on the panel

IP68 neoprene cap - Part number: **31091**
Nota: plan a type M3 hole on the panel



CAPS for plugs

Cap in neoprene
Part number: **31092**



CAPS for in line receptacles

Cap in neoprene
Part number: **31093**



Dummy female receptacle

Part number: **31131 x**



- x** to be replaced by
- B** for Black nickel plating
- G** for Olive drab cadmium plating
- U** for Unplated brass

TOOLS



- Nut clamping tool for receptacle
Part number: **31055**
Only for RPx receptacles



- Insertion tool for crimp contacts
Part number: **31056**



- Contact positioner for M22520/2-01 crimping tool
Part number: **31095**

Other tools:

- Brazing tool for receptacle & in-line receptacle
Part number: **31132**
- Brazing tool for plug
Part number: **31133**

Nota: the assembling instructions are available upon demand (ref. N00-040190-00).