

PVA Short Stroke Key Switches



A
Pushbutton

Features/Benefits

- Compact design
- Short stroke to latch
- Wide variety of actuator heights
- Adapted for medium power applications
- RoHS compliant and compatible

Typical Applications

- Automotive (air conditioning, lighting)
- Industrial
- Control panel



Construction

FUNCTION: Momentary, Push-Push
 CONTACT ARRANGEMENT:
 PVA1: 2 make contacts (DPST)
 PVA2: 2 change over contacts (DPDT)
 SWITCHING MODE: Non-shorting
 TERMINALS: PC pins¹

Mechanical

TOTAL TRAVEL / LATCHING TRAVEL:
 OA: 2,4 mm
 EE: 2,4 / 1,5 mm
 ELECTRICAL TRAVEL: 0.8 mm (1.1 for PVA2 OA H5)
 OPERATING FORCE: 1,2N; 1,7N; 3,5N

Process

SOLDERABILITY:
 Wave soldering, compatible with lead free soldering profile
 Hand soldering, 350°C for 3 seconds

Note: Specifications listed above are for switches with standard options.
 For information on specific and custom switches, please contact technical support using the "Ask a Specialist" option on the PVA product web page.v

Electrical

SWITCHING POWER MAX.: 3 W DC
 SWITCHING VOLTAGE MAX.: 32 V DC
 SWITCHING CURRENT MAX.: 100 mA DC*
 DIELECTRIC STRENGTH (50 Hz / 1 min):
 1000 V between open contacts, PVA2: 750 V
 OPERATING LIFE:
 OA (momentary): $\geq 1 \times 10^5$ operations
 EE (push-push): $\geq 1 \times 10^6$ operations
 CONTACT RESISTANCE: Initial $\leq 100 \text{ m}\Omega$
 INSULATION RESISTANCE: $\geq 10^{10} \Omega$
 BOUNCE TIME: $\leq 3 \text{ ms}$

Environmental

OPERATING TEMPERATURE: -40°C to 85°C.²

- 1) "Snap-in" contacts on request, Version SNA with pins bent inside (standard)
- 2) With button +70°C

How To Order

Our easy build-a-switch concept allows you to mix and match options to create the switch you need. To order, select desired option from each category and place it in the appropriate box. **Some of the configurations may not be available or could require some development.**

Switch



Button

Buttons must be ordered separately.
 Shipped in bulk.

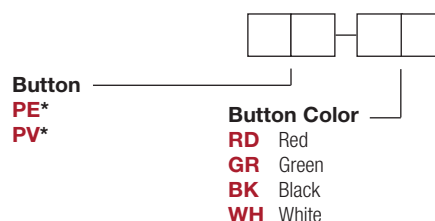

*Compatible with H1 and H3 actuator models only.



PVA Short Stroke Key Switches

A

SERIES



Pushbutton

PVA1 (DPST)



PVA2 (DPDT)



MECHANICAL FUNCTION



OPTION CODE	FUNCTION
OA	Momentary
EE	Push-Push

OA



EE



11 Jun 18

Dimensions are shown: mm
Specifications and dimensions subject to change

PVA Short Stroke Key Switches



A

Pushbutton

TOTAL HEIGHT



H1 17,5 MM

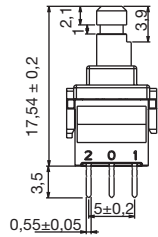

H2 23 MM

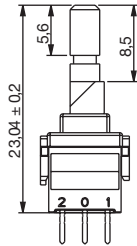

H3 20,5 MM

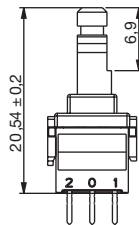

H4 15 MM

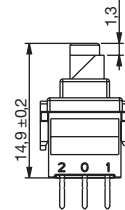

H5 13 MM
(MOMENTARY ONLY)

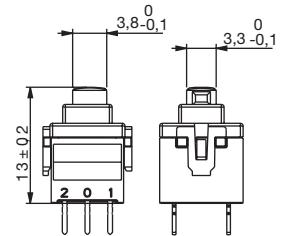

OPERATING FORCE



- 1.2N** PVA1 ONLY
- 1.7N** PVA2 ONLY
- 3.5N**

TERMINATION



SNA with PVA1

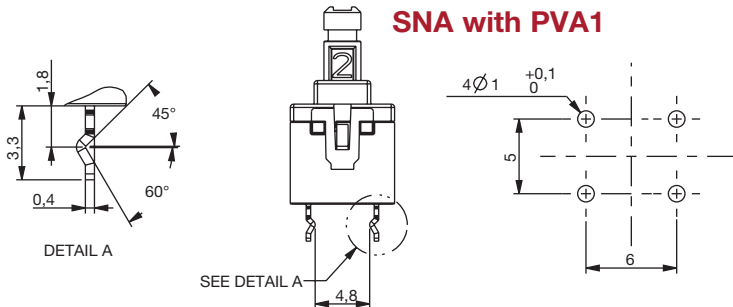

SNA with PVA2

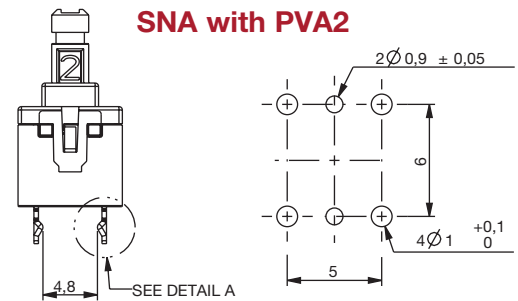

BUTTONS

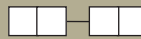

BUTTONS MUST BE ORDERED SEPARATELY. SHIPPED IN BULK.

PE

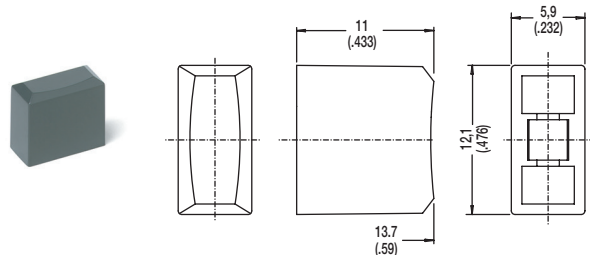

PV

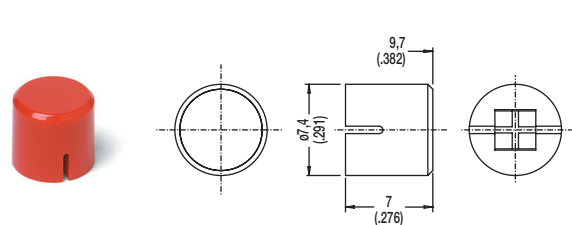

OPTION CODE	COLOR
RD	Red
GY	Gray
BK	Black
WH	White