

KR series

Power rocker switches

Distinctive features

Attractive rugged rocker switch

UG1410A-R2

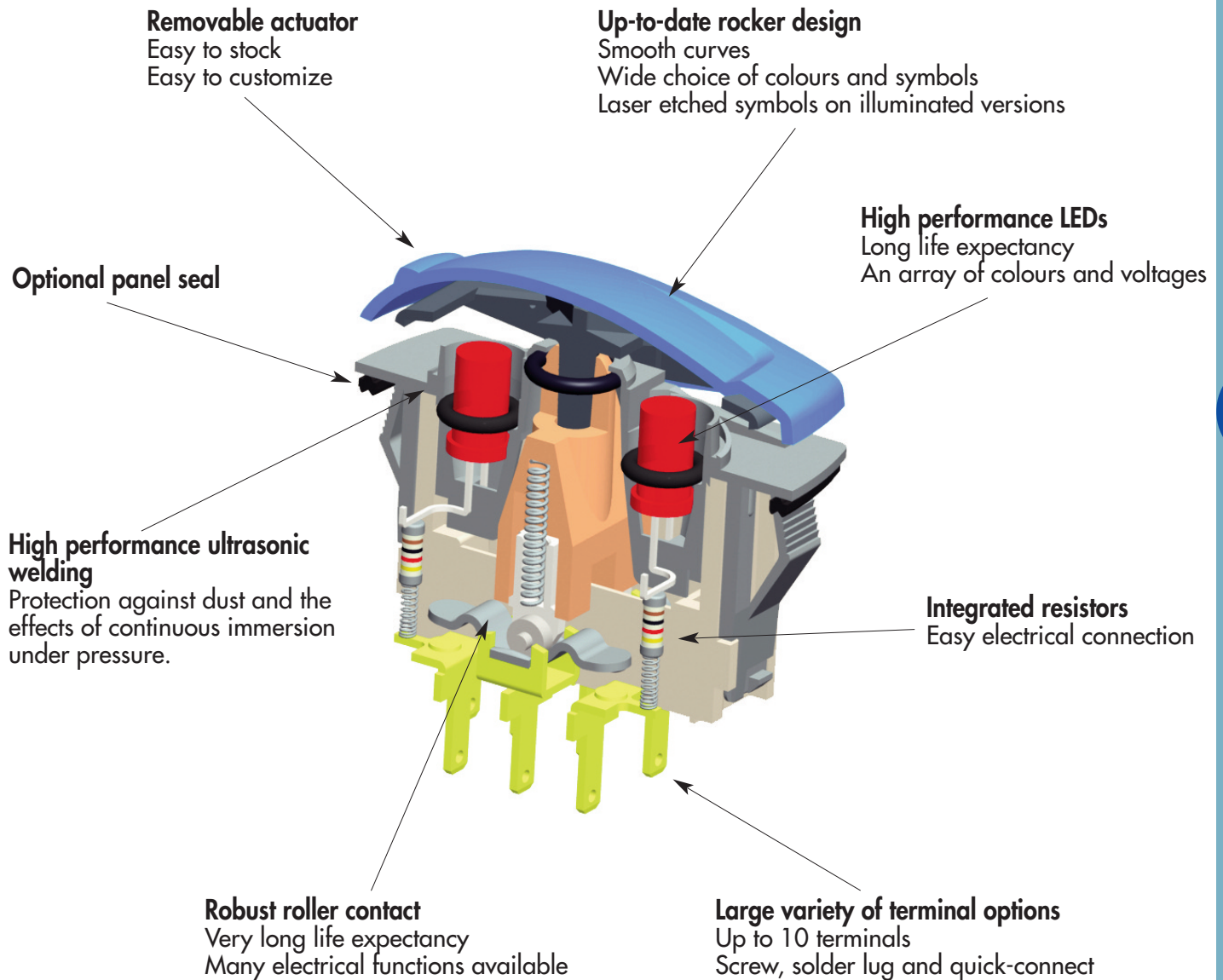

APEM will be happy to develop custom product solutions. Please contact us with your requirements.

The company reserves the right to change specifications without notice.

KR series

Power rocker switches

Specifications



- Unique rocker design
- Wide choice of colours
- Laser etched symbols
- Illuminated or non-illuminated
- Optionally sealed to IP68 or IP69K

ELECTRICAL SPECIFICATIONS

- Current/voltage rating with resistive load :
 - Silver plated contacts :
 - A** : 5A 24VDC, 100.000 cycles - 10A 24VDC, 10.000 cycles (terminals 6.35 x 0.8 only)
 - S** : 20A 12VDC, 10.000 cycles (see Overview)
 - Gold plated contacts (D) : 20mA 12V, 150.000 cycles
- Current/voltage rating with lamp load - silver contacts (A) :
 - functions 1 & 6 : 100W 24VDC, 10.000 cycles
 - other functions : 60W 24VDC, 10.000 cycles
- Initial contact resistance : 10 mΩ max.
- Insulation resistance : 1.000 MΩ min. at 500VDC
- Dielectric strength : 2.000 Vrms 50 Hz min. between terminals
- Mechanical life : 150.000 cycles min.

MATERIALS

- Case : PA 6-6
- Actuator : ABS
- Bezel : PA 6-6
- Contacts & terminals : brass, solid silver grain, silver plated (**A or S**) or brass, solid silver grain, gold plated (**D**)
- Contact roller : brass, nickel plated

SEALING

Sealing is optional.
To order a sealed product, complete the appropriate box of ordering format on the following pages.

ENVIRONMENTAL SPECIFICATIONS

- Sealing options :
 - K : IP68 to front panel components of switch only according to IEC 60529
 - Z : IP69K panel sealing according to DIN 40050-9
- Salt spray resistance : 96 hours according to IEC 512-6, test 11f
- Vibration resistance : 10-500 Hz / 10 g per IEC 60068-2-6
- Operating temperature : -40°C to +85°C

DIMENSIONS

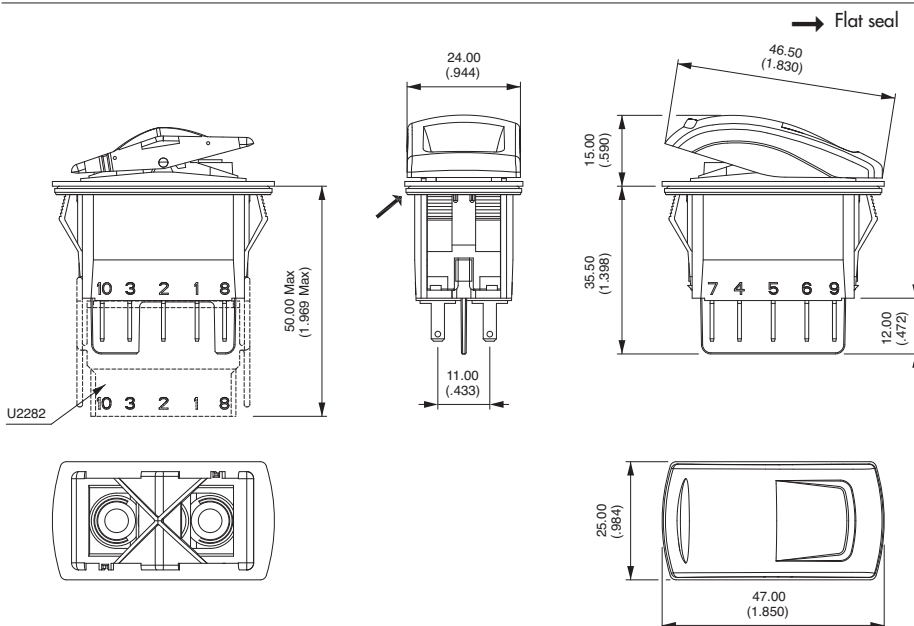

Packaging unit : 40 pieces

Dimensions : First dimensions are in mm while inches are shown as bracketed numbers.

KR series

Power rocker switches

Overview

HOW TO ORDER

- To order a complete product, fill in all the boxes of the following order guide.
- To order case only (without actuator), finish your order number with the LED wiring code.
- To order actuator only (without case), begin the order number with code KRR, then follow the order format from "actuator type" until the end of the options.

CASE + LEDS

KR						Side A	Side B	
SERIES	Poles		Contacts	Sealing	LEDS	Wiring		
	3 Single pole 4 Double pole		A Silver D Gold plated S Silver 20A *	X No K IP68 Z IP69K	X None A LED 6V red B LED 6V green C LED 6V yellow M LED 6V blue R LED 6V white D LED 12V red E LED 12V green F LED 12V yellow N LED 12V blue S LED 12V white J LED 24V red K LED 24V green L LED 24V yellow P LED 24V blue T LED 24V white ...	See following pages.		
	Electrical functions	Terminals	Terminals (continued)					
	1 ON - OFF 4 ON ON ON 4-1R ON ON MOM 5 MOM - ON 6 ON - ON 7 MOM OFF MOM 8 ON OFF MOM 9 ON OFF ON Function 1 only for 6-terminal versions.	Screw 0 6 terminals with barrier Solder lug/quick-connect 2 6 terminals with barrier 4 6 terminals w/o barrier A 10 term. with barrier B 10 term. w/o barrier C 10 terminals for use with connector U2292 or U3152 Normalized quick-connect 6,35x0,8 3 6 terminals with barrier	5 6 terminals w/o barrier D 10 term. with barrier E 10 term. w/o barrier F 10 term. for use with connector U2292 or U3152 Normalized quick-connect 2,8x0,8 G 10 term. with barrier H 10 term. w/o barrier J 10 terminals for use with connector U2282					

* S contacts for all functions except 4 and 4-1R - for normalized quick-connect terminals 6,35x0,8 only.

ACTUATOR

Type	Colour
1 For non-illuminated application 2 For illuminated application	1 Blue 1/4 Dark blue 2 Black 3 Green 4 Grey 5 Yellow 6 Red 7 Ivory 9 Orange A Aluminium bright

ACTUATOR MARKING

	Area A	Area M	Area B
Orientation	Symbols		
N O S E			
	Symbols & Accessories : see end of section D.		



NOTICE : please note that not all combinations of above numbers are available. Refer to the following pages for further information.

KR series

Power rocker switches

Case

- To order case only (without rocker), finish your order number with the LED wiring code.

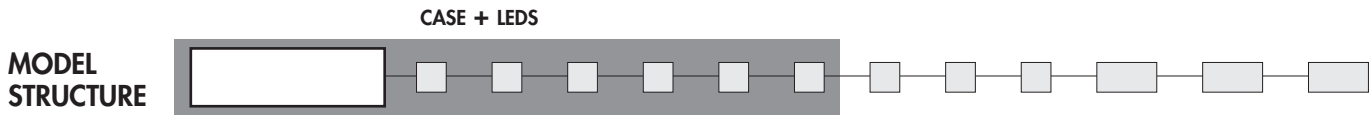

	Single pole	Double pole	2-3	1-2
KR31	ON	ON	5-6	4-5
KR35	MOM	MOM		
KR36	ON	ON		
KR37	MOM	OFF		MOM
KR38	ON	OFF		MOM
KR39	ON	OFF		ON
KR41	ON	ON		ON
KR44*	ON	ON		ON
KR44-1R*	ON	ON		MOM
KR45	MOM	MOM		ON
KR46	ON	ON		ON
KR47	MOM	OFF		MOM
KR48	ON	OFF		MOM
KR49	ON	OFF		ON

Bottom view

10 terminal version

6 terminal version

* Function 4 : single pole in double pole case

D

ELECTRICAL FUNCTIONS AND CONNECTIONS

In the tables below, terminal connections as viewed from bottom of switch.
Only the contact area is represented.
For single pole models, only terminals 1, 2 and 3 are to be considered (not terminals 6, 5, 4).

x = w/o terminal
o = with terminal
▲ = momentary

	Positions		
Function 1 * KR31-KR41			
Function 5 KR35-KR45			
Function 6 KR36-KR46			
Function 7 KR37-KR47			
Function 8 KR38-KR48			
Function 9 KR39-KR49			
Function 4 KR44			
Function 4-1R KR44-1R			

* Function 1 only available for 6 terminal versions.

KR series

Power rocker switches

Case

TERMINALS

CASE + LEDS



Screw

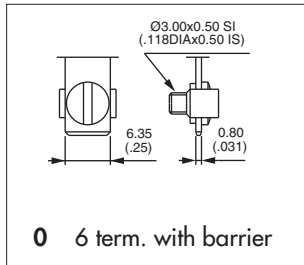

Solder lug / quick-connect

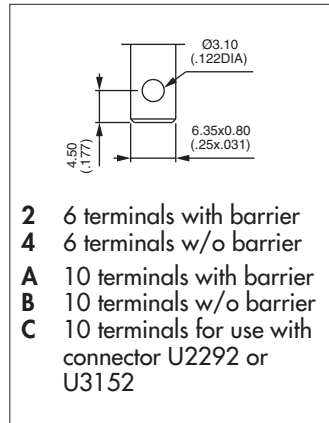

Normalized quick-connect 6,35x0,8

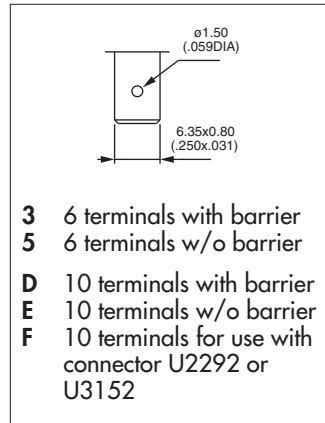

Normalized quick-connect 2,8x0,8

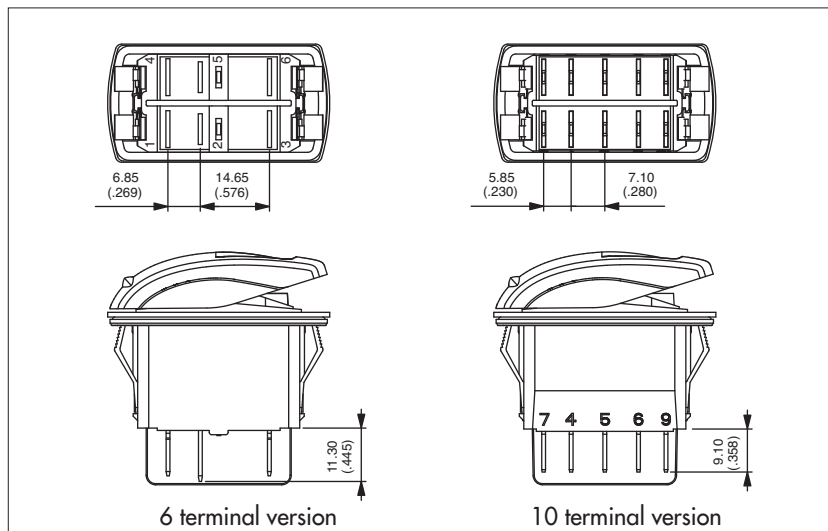
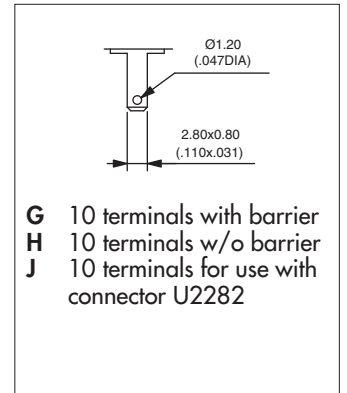

Terminals are marked on the case.

The drawings show the maximum possible number of terminals.

D

CONTACT MATERIALS

CASE + LEDS



- A** Silver
- D** Silver, gold plated
- S** Silver 20A **NEW!**
For all functions except 4 and 4-1R - for normalized quick-connect terminals 6,35x0,8 only.

KR series

Power rocker switches

Case - LEDs

SEALING

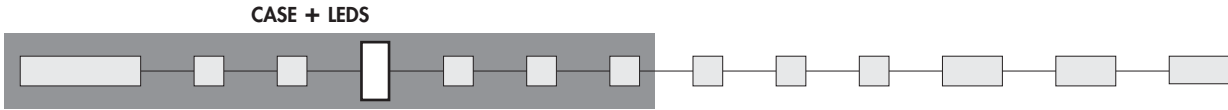

- X** No sealing
- K** IP68 (front panel components of switch only)
- Z** IP69K - Installation notice available on request

Ultrasonic welding of frame to case is standard on all versions.
The ultrasonic welding and the optional panel seal prevent water and dust from introducing into the switch housing.

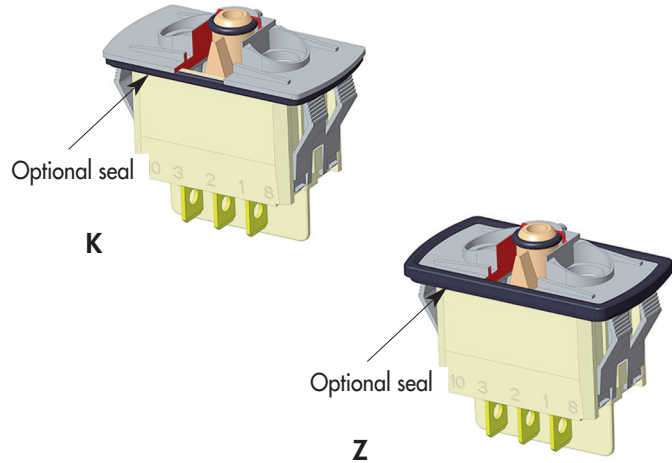

D

LEDS

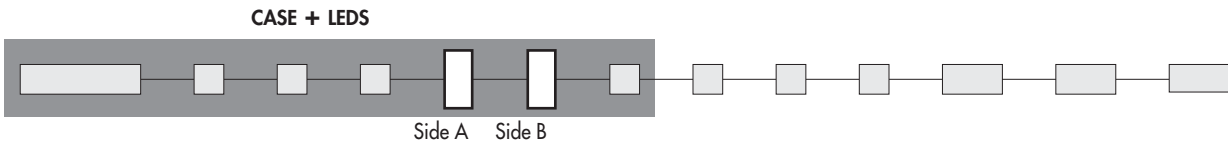

Complete each enlarged box with one of the codes listed below.

- X** Without LED

	Red	Green	Yellow	Blue	White	Amber	Red/green
6VDC	A	B	C	M	R	4	1
12VDC	D	E	F	N	S	5	2
24VDC	J	K	L	P	T	6	3
No resistor	U	V	W	Y	Z	9	8

LED consumption : 20mA @ nominal voltage (25°C)
Other illumination solutions : on request.

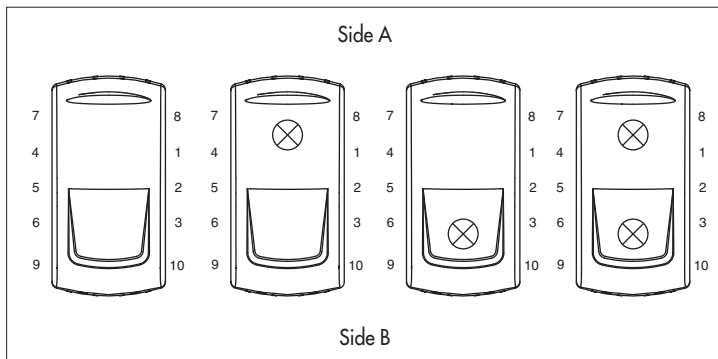

KR series

Power rocker switches

Case - LEDs

WIRING

The LED wiring diagram is shown on the case.

CASE + LEDs

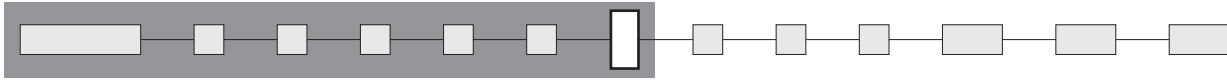

• For 6 terminal versions

LED connected to the load

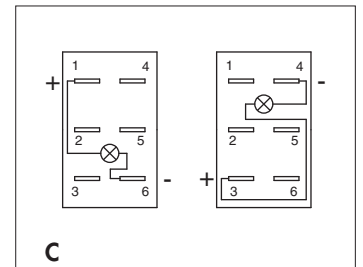
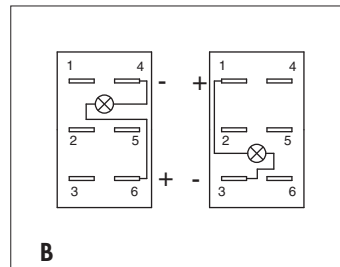
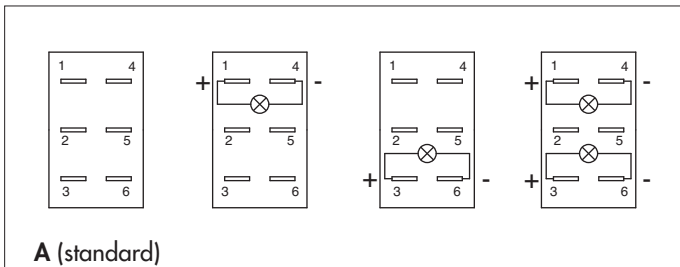

Note : If not available, terminals are added to connect the LED.

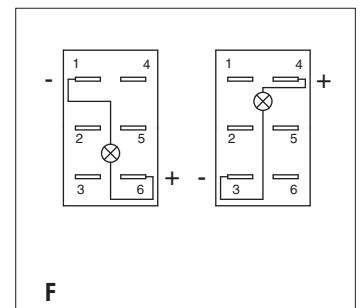
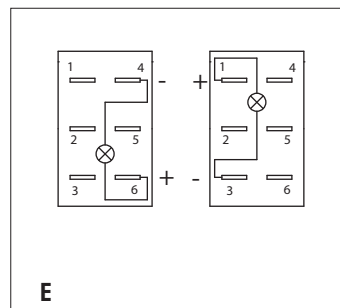
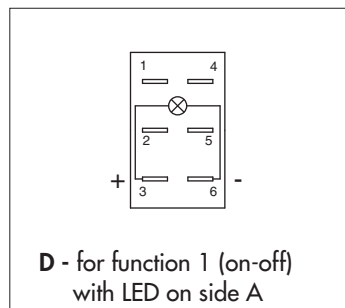

• For 10 terminal versions

Independent LED or integrated functions

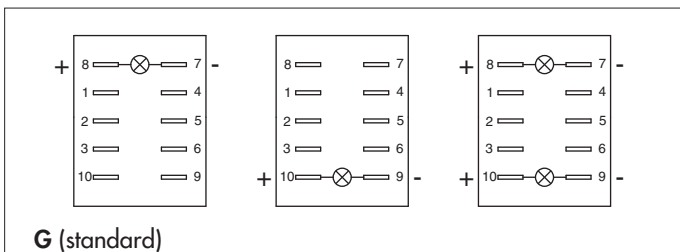

To have independent LEDs.

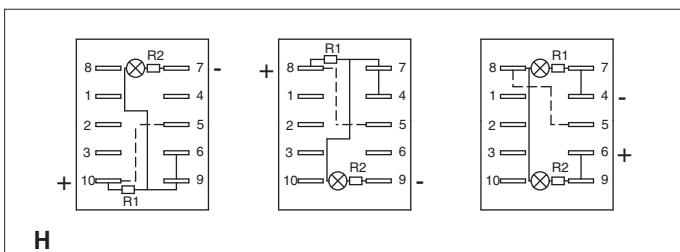

To obtain 2 symbol illumination levels (night illumination when OFF and higher illumination when ON).

H wiring with LED on side A available with functions 6, 8, 9 and 44.

H wiring with LED on side B available with functions 5, 6 and 9.

H wiring with 2 LEDs available with functions 8 and 9.

More information (H wiring schematics) : on request.

Dotted line = external wiring, continuous line = internal wiring

Available in Single Pole only, with H and J quick-connect terminals.

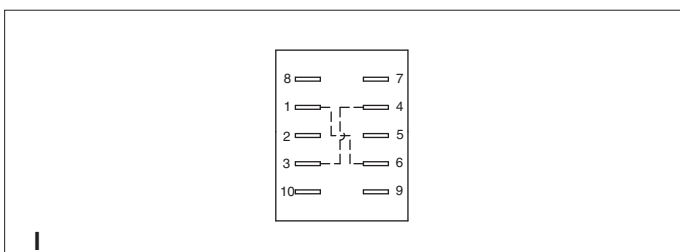

Power supply between 2 and 5 - Load between 1 and 4 or 3 and 6. Available with H and J quick-connect terminals.

To have a polarity inversion (typical application : fan motor).

Dotted line = external wiring

Please contact us for other wiring solutions.

KR series

Power rocker switches

Actuator - Marking

To order actuator only (without case), begin the order number with code KRR, then follow the order format from "actuator type" until the end of the options.

ACTUATOR TYPE

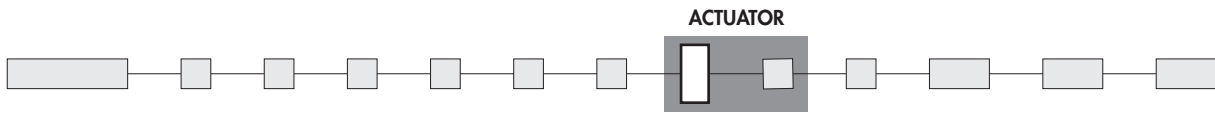

- 1 For non-illuminated application
- 2 For illuminated application

Other rocker design : on request.

ACTUATOR COLOUR

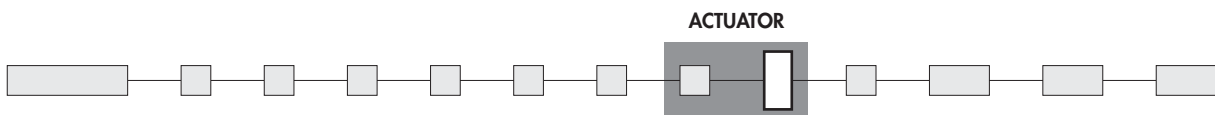

Code	Colour
1	Blue
1/4	Dark blue
2	Black
3	Green

Code	Colour
4	Grey
5	Yellow
6	Red
7	Ivory

Code	Colour
7/1	White
9	Orange
A	Aluminium bright

Note : colours 7 and 7/1 not available on illuminated versions.

A **soft-touch varnish** can be added. Consult us.



MARKING ORIENTATION

If no marking required, complete the box with code N.

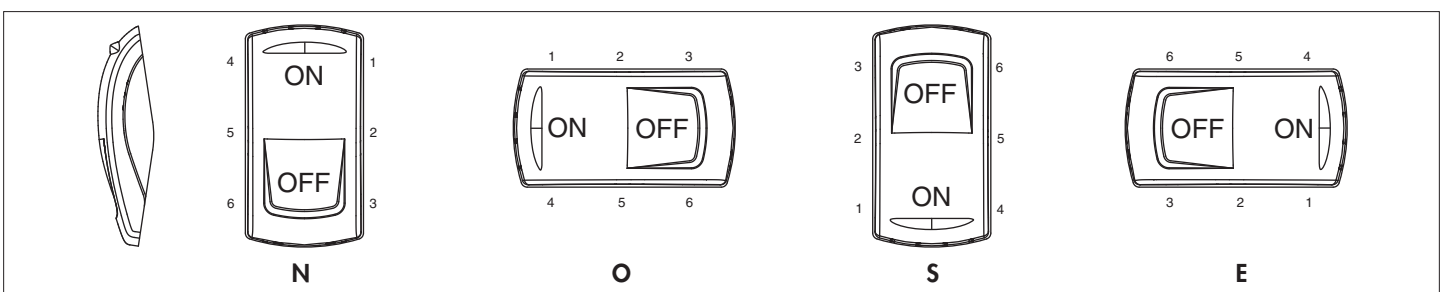
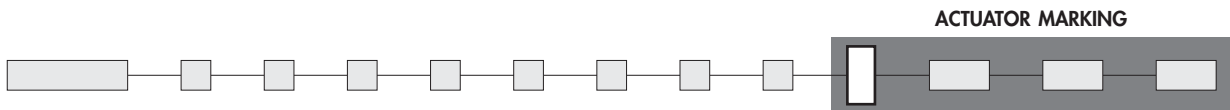

Other orientations : on request

KR series

Power rocker switches

Marking - Mounting

SYMBOLS

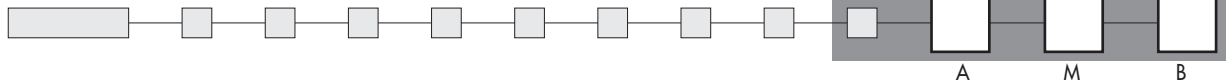

XX No symbol

Available symbols : see end of section D.

Marking colour

White marking for illuminated rockers (laser etching) and non-illuminated black rockers (pad printing). Black marking for non-illuminated colour rockers (pad printing). Other : on request.

Laser etching resistance

- Water and petrol resistant according to EN61058-1
- Tear resistant (cross-cut test) according to NF ISO 2409 : class 0
- UV resistant according to ISO 4892-2

Marking area

For illuminated versions. The symbol will be included in the hatched area. Marking in M area : on request.

ACTUATOR MARKING

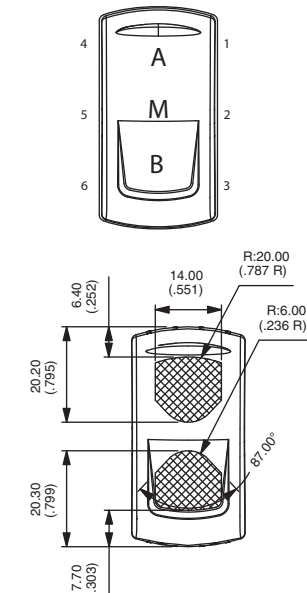
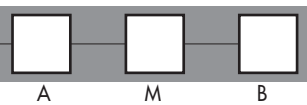

MATRIX MOUNTING

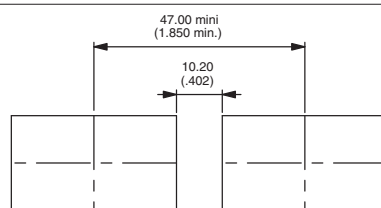
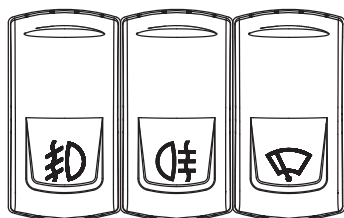
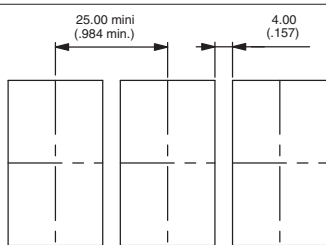

PANEL CUT-OUT

Panel thickness : 0,8 mm to 4,6 mm
Recommended panel thickness : between 2 mm and 3,5 mm

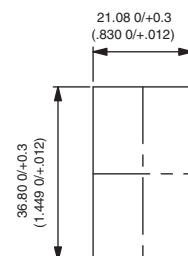

SPECIFIC MATRIX MOUNTING FOR Z VERSION

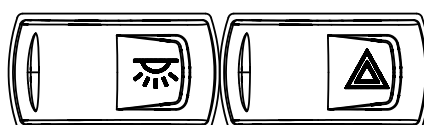
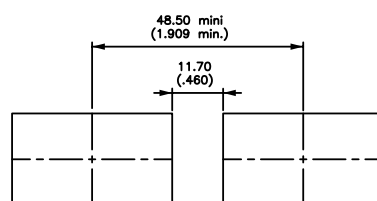
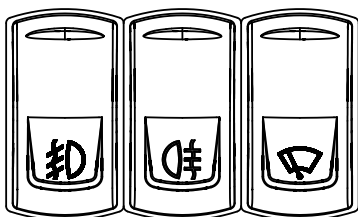
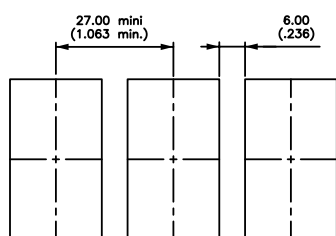

K range

Power rocker switches and indicators

Symbols

Most symbols meet the ISO 7000 standard "graphical symbols for use on equipments" (code given in bracket in the description). Contact us for symbols not featured in the following tables.

Legend scale :

KR series : 1:1

KL, KG and KI series : depending on space available on the product (see "Symbols" section at the end of each series).

CODE	SYMBOL	DESCRIPTION
XX	None	-
01	ON	-
02	OFF	-
03	○	-
04	I	-
05	II	-
06	STOP	-
07	A	Stop
08	M	Motion
09	▲	Up motion
10	▼	Down motion
11	☀	Hot
12	✱	Cold
13	⚠	Hazard warning (0085)
14	☰	Traveller lighting
15	☷	Driver lighting (1421)

CODE	SYMBOL	DESCRIPTION
16	☰	Revolving light
17	☰	Rear ventilator
18	☰	Heating (0637)
19	☰	Door opening
20	☰	Windshield demister/defroster (0635)
21	☰	Windshield wiper (0086)
22	☰	Windshield washer (0088)
23	☰	Ventilator fan (0089)
24	☰	Side mirror defroster
25	☰	Restarting pump
26	☰	Front fog lights (0633)
27	☰	Rear fog lights (0634)
28	☰	Propulsion system trim
29	☰	Beacon (1141)
30	☰	Anchor
31	☰	Electric motor (0011)

CODE	SYMBOL	DESCRIPTION
32	☰	Emergency first aid vehicle (2565)
33	☰	Load tipping (1557)
34	☰	Loading light (2457)
35	☰	Tractor, rear-ward (1667)
36	☰	Combine, direction of movement (1678)
37	☰	Use no forks (2406)
38	☰	Transmission (1166)
39	☰	Working spot light (1145)
40	☰	Engine (0640)
41	☰	Horn (0244)
42	☰	Lock (1656)
43	☰	Taxi sign light (2551)
44	☰	Working light (1204)
45	☰	Working light symmetric (1204)
46	☰	-
47	ASM	-

K range

Power rocker switches and indicators









































Symbols

Most symbols meet the ISO 7000 standard “graphical symbols for use on equipments” (code given in bracket in the description). Contact us for symbols not featured in the following tables.

Legend scale :

KR series : 1:1

KL, KG and KI series : depending on space available on the product (see “Symbols” section at the end of each series).

CODE	SYMBOL	DESCRIPTION	CODE	SYMBOL	DESCRIPTION	CODE	SYMBOL	DESCRIPTION
48		All wheel drive	64		Indicator	80		Front windshield heating
49		Differential lock (1662)	65		Brake release	81	AUS	Aus
50		-	66		Baggage room left door	82		Radiator fan
51		-	67		Baggage room right door	83		Remove retarder
52		-	68		Power blinds	84		Restricted speed
53	N	-	69		Engine idle control	85		Preheater
54		Rear window wiper (0097)	70	CRUISE RES/SET	Cruise res/set	86		ABS detection
55		Rear window washer (0099)	71		Driver windows up/down	87		ECAS detection
56		Lower load (2223)	72		Middle door opening	88		Engine stop
57		Cab lock (1560)	73		Front door opening	89	CRUISE RES/CAN	Cruise res/cancel
58		Extraction	74		Lighting in baggage room	90		ECAS reset
59		Pumping in	75	CRUISE ON/OFF	Cruise on/off	91		Driver windows heating
60		Rear PTO (1572)	76	TV	TV	92	CRUISE SET+/SET-	Cruise set
61		Front PTO	77		Pump	93		Air bag up/down
62		Rockshaft down	78	WC	Toilet	94		Read lighting
63		Rockshaft up	79		Toilet decontamination	95		Lighting main switch

K range

Power rocker switches and indicators

















Symbols

















Most symbols meet the ISO 7000 standard “graphical symbols for use on equipments” (code given in bracket in the description). Contact us for symbols not featured in the following tables.





Legend scale :

KR series : 1:1

KL, KG and KI series : depending on space available on the product (see “Symbols” section at the end of each series).

CODE	SYMBOL	DESCRIPTION
96		Heating using water
97		Low beam
98		Position lights
99		Diesel acceleration
A1		Manual mode
A2		Clockwise cabin rotation
A3		Anticlockwise cabin rotation
A4		-
A5		-
A6		Parking brake
A7		-
A8		-
A9		-
AA		-
AB		-
AC		-

CODE	SYMBOL	DESCRIPTION
AD		-
AE		-
AF		-
AG		Battery charging condition (0247)
AH		Turn signals (0084)
AJ		High beam (0082)
AK		Differential lock, bogie (2600)
AL		Brushing with a rotating brush (0070)
AM		Differential lock, transfer case 4x4 (2475)
AN		Loader bucket, float (1441)
AP		Loader bucket (1437)
AQ		Rear window washer & wiper (0098)
AR		Header Header drive (1579)
AS		Excavator/backhoe boom side shift (2091)
AT		Chemical water treatment (1851)
AU		Grapple skidder, single funct ^o boom (1762)

CODE	SYMBOL	DESCRIPTION
AV		-
AW		-
AY		-
AZ		-
B1	HIGH	-
B2	LOW	-
B3		-

K range

Power rocker switches and indicators

Accessories for KR, KL and KI series

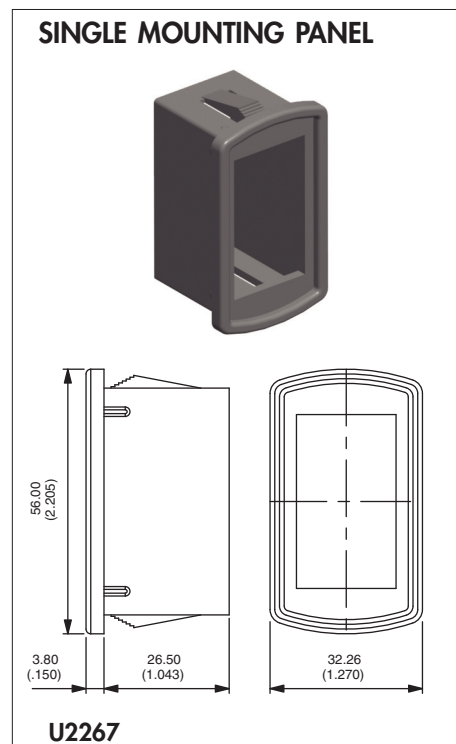
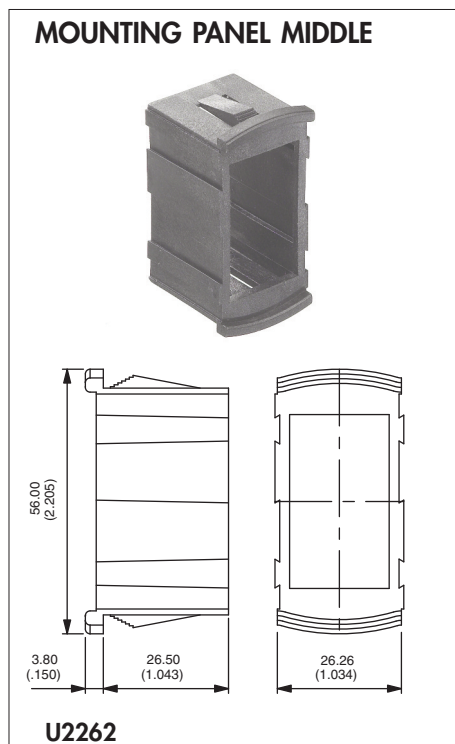
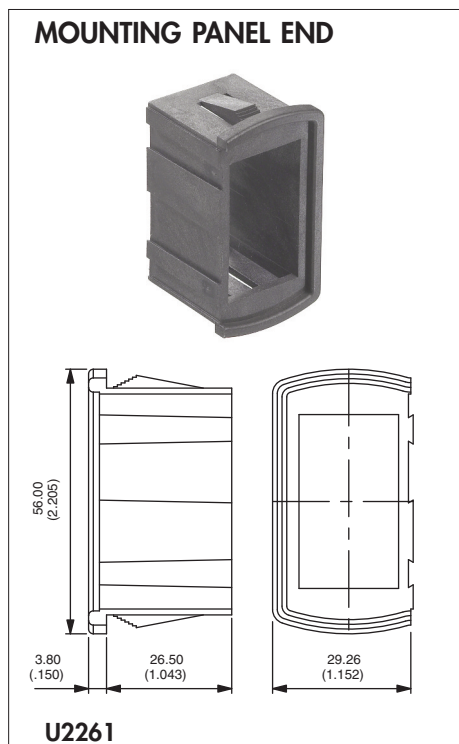

Recommended panel thickness : 1,10 mm - 1,80 mm - 2,60 mm - 3,40 mm - 4,20 mm - 5 mm - 5,80 mm

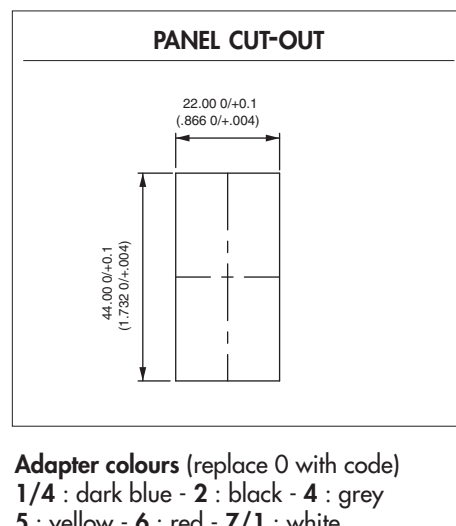
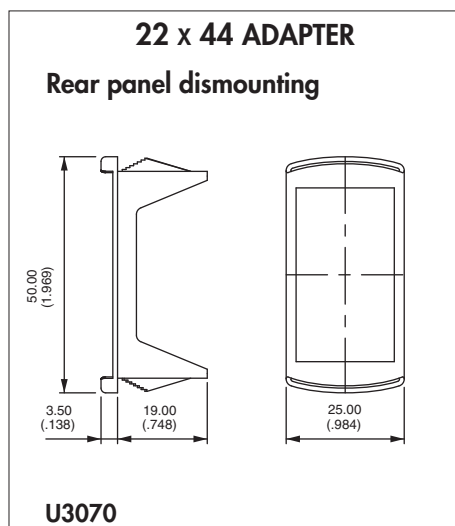
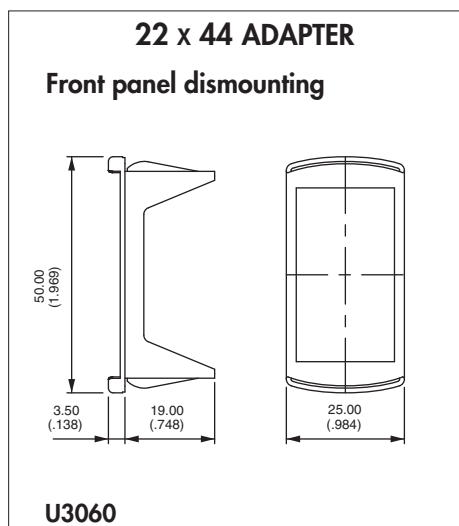
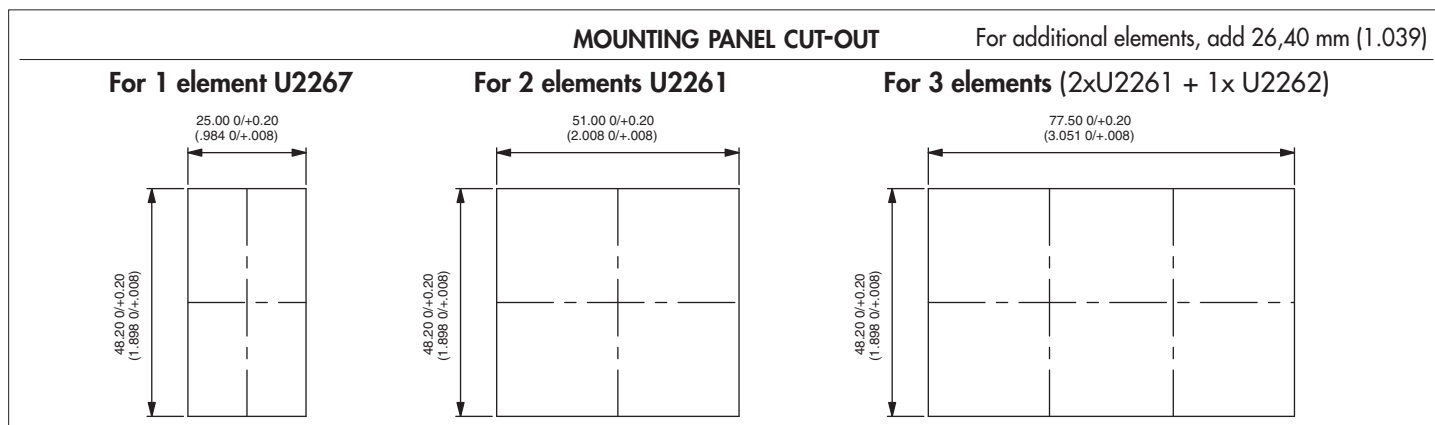

Recommended panel thickness : 0,60 mm to 1,50 mm

Recommended panel thickness : 1,60 mm -0,1/0 to 5,60 mm -0,1/0 in stages of 0,40 mm

K range

Power rocker switches and indicators

Accessories for KR, KL and KI series

ACTUATOR REMOVING TOOL



U3052

2 tools are supplied

EXTRACT ACTUATOR (KR ONLY)

Allows the extraction of the rocker / rocker support assembly.
Place the 2 claws under the support and push as indicated by the arrow.

EXTRACT ROCKER (KR ONLY)

Allows to separate the rocker from its support.

Insert the tool between rocker and support as indicated by the arrow. Pull out the tool in the opposite direction.

EXTRACT SWITCH (KR, KL AND KI)

Allows to extract switch from panel mounting units. 2 tools are necessary.

Insert the tools between switch and panel mounting units from the rear to compress the snap-in device. Pull off switch manually.

CONNECTORS

Standard colour : black. Other colours : on request.
Connectors cannot be combined with wiring types H and I.



U2260

6 terminal version

For use with terminals type 2, 3, 4 or 5.
6,35 (1/4) tabs to be fitted by the user
(example : TE42282-2).
Can be used for the KG series.

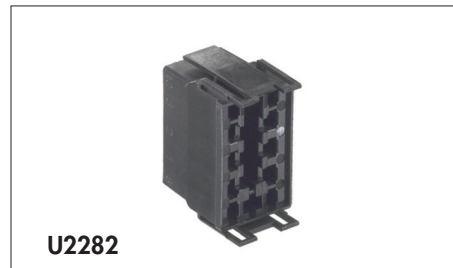

U2282

10 terminal version

For use with terminals type H or J.
2,8 (.110) tabs to be fitted by the user
(example : AMP/Tyco 0-927779-3).



U2292

10 terminal version

For use with terminals type B, C, E or F.
6,35 (1/4) tabs to be fitted by the user
(example : TE42282-2).

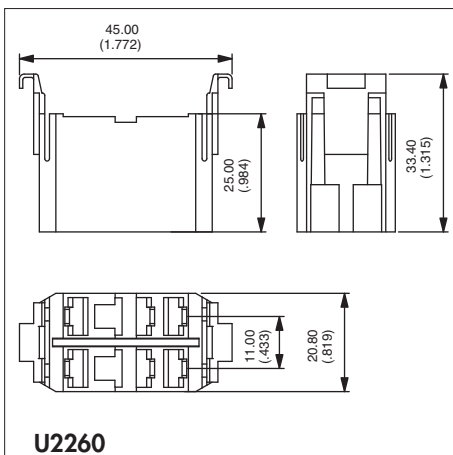

U2260

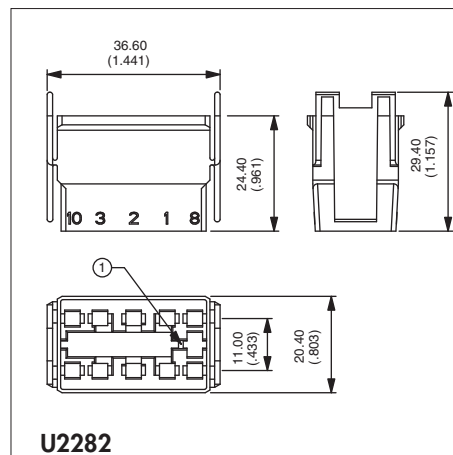

U2282

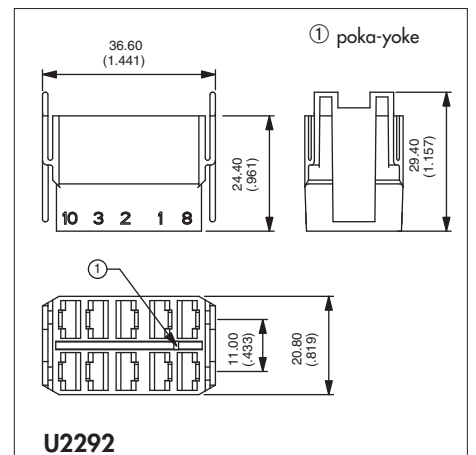

U2292

K range

Power rocker switches and indicators

Accessories for KR, KL and KI series

CONNECTORS (continued)



U3152

New!

10 terminal version

For use with terminals type B, C, E or F.
6,35 (1/4) tabs to be fitted by the user
(example : «Timer» terminals TE927833-2)

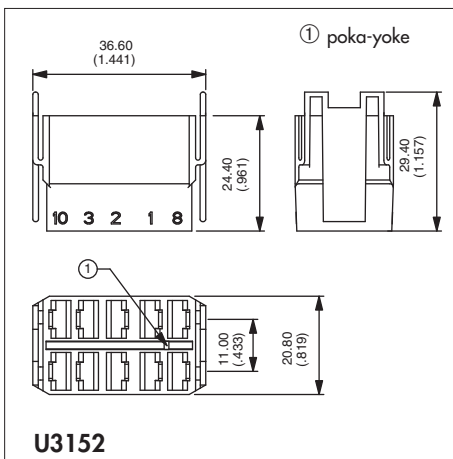

U3152

BLANKING CAPS

Usefull for future extensions.

Code	Colour	Code	Colour
U2271	Blue	U2274	Grey
U2271/4	Dark blue	U2275	Yellow
U2272	Black	U2276	Red
U2273	Green	U2277	Ivory
		U2279	Orange

Recommended panel thickness :
1,50 mm to 6 mm

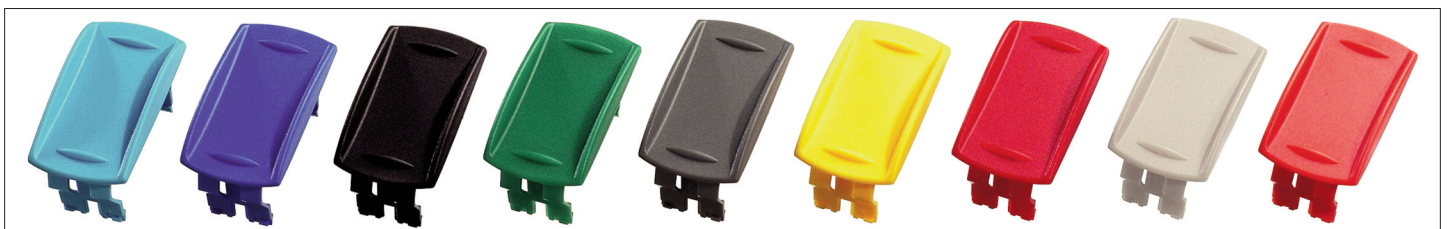
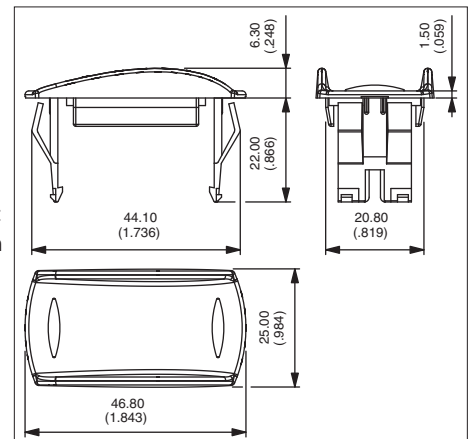

Connectors can be hanged on specific hole plugs. Contact APEM.