

# Thyristor Modules

## Thyristor/Diode Modules

 $I_{TRMS} = 2x 180 A$   
 $I_{TAVM} = 2x 116 A$   
 $V_{RRM} = 800-1800 V$ 

$V_{RSM}$	$V_{RRM}$	Type					
$V_{DSM}$	$V_{DRM}$		1B	8B	Version	1B	8B
V	V	Version					
900	800	MCC 95-08	io1B / io8B		MCD 95-08	io1B / io8B	
1300	1200	MCC 95-12	io1B / io8B		MCD 95-12	io1B / io8B	
1500	1400	MCC 95-14	io1B / io8B		MCD 95-14	io1B / io8B	
1700	1600	MCC 95-16	io1B / io8B		MCD 95-16	io1B / io8B	
1900	1800	MCC 95-18	io1B / io8B		MCD 95-18	io1B / io8B	

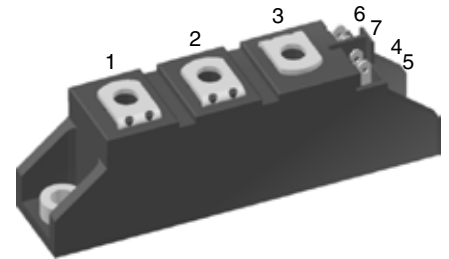

Symbol	Conditions	Maximum Ratings	
$I_{TRMS}, I_{FRMS}$ $I_{TAVM}, I_{FAVM}$	$T_{VJ} = T_{VJM}$ $T_C = 85^\circ C; 180^\circ \text{ sine}$	180	A
		116	A
$I_{TSM}, I_{FSM}$	$T_{VJ} = 45^\circ C$ $V_R = 0$ $t = 10 \text{ ms}$ (50 Hz) $t = 8.3 \text{ ms}$ (60 Hz)	2250	A
		2400	A
	$T_{VJ} = T_{VJM}$ $V_R = 0$ $t = 10 \text{ ms}$ (50 Hz) $t = 8.3 \text{ ms}$ (60 Hz)	2000	A
		2150	A
$I^2t$	$T_{VJ} = 45^\circ C$ $V_R = 0$ $t = 10 \text{ ms}$ (50 Hz) $t = 8.3 \text{ ms}$ (60 Hz)	25 300	A <sup>2</sup> s
		23 900	A <sup>2</sup> s
	$T_{VJ} = T_{VJM}$ $V_R = 0$ $t = 10 \text{ ms}$ (50 Hz) $t = 8.3 \text{ ms}$ (60 Hz)	20 000	A <sup>2</sup> s
		19 100	A <sup>2</sup> s
$(di/dt)_{cr}$	$T_{VJ} = T_{VJM}$ $f = 50 \text{ Hz}; t_p = 200 \mu s;$ $V_D = 2/3 V_{DRM}$ $I_G = 0.45 \text{ A}$ $di_G/dt = 0.45 \text{ A}/\mu s$	repetitive, $I_T = 250 \text{ A}$	150 A/ $\mu s$
		non repetitive, $I_T = I_{TAVM}$	500 A/ $\mu s$
$(dv/dt)_{cr}$	$T_{VJ} = T_{VJM}; V_D = 2/3 V_{DRM}$ $R_{GK} = \infty; \text{method 1 (linear voltage rise)}$	1000	V/ $\mu s$
$P_{GM}$	$T_{VJ} = T_{VJM}; t_p = 30 \mu s$ $I_T = I_{T(AV)M}; t_p = 500 \mu s$	10	W
		5	W
$P_{GAV}$		0.5	W
$V_{RGM}$		10	V
$T_{VJ}$		-40...+125	°C
$T_{VJM}$		125	°C
$T_{stg}$		-40...+125	°C
$V_{ISOL}$	50/60 Hz, RMS $I_{ISOL} \leq 1 \text{ mA}$	$t = 1 \text{ min}$ $t = 1 \text{ s}$	3000 V~ 3600 V~
$M_d$	Mounting torque (M5) Terminal connection torque (M5)	2.5 - 4 2.5 - 4	Nm Nm
Weight	Typical including screws	85	g

Data according to IEC 60747 and refer to a single diode unless otherwise stated.

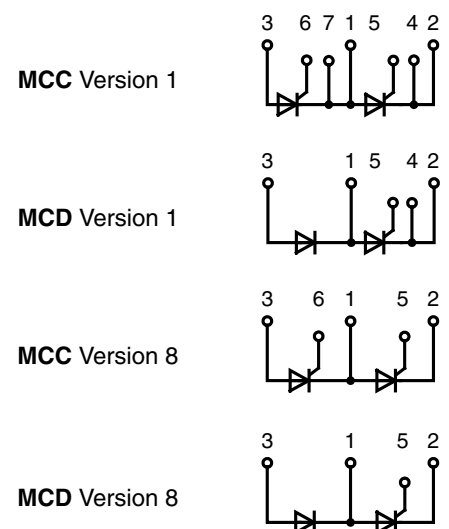

### Features

- International standard package, JEDEC TO-240 AA
- Direct copper bonded  $Al_2O_3$  -ceramic base plate
- Planar passivated chips
- Isolation voltage 3600 V~
- UL registered, E 72873
- Gate-cathode twin pins for version 1

### Applications

- DC Motor control
- Softstart AC motor controller
- Light, heat and temperature control

### Advantages

- Space and weight savings
- Simple mounting with two screws
- Improved temperature & power cycling
- Reduced protection circuits

Symbol	Conditions	Characteristic Values	
		typ.	max.
$I_{RRM}, I_{DRM}$	$V_R / V_D = V_{RRM} / V_{DRM}$	$T_{VJ} = T_{VJM}$	5 mA
$V_T, V_F$	$I_T / I_F = 300$ A	$T_{VJ} = 25^\circ\text{C}$	1.5 V
$V_{T0}$	For power-loss calculations only		0.8 V
$r_t$		$T_{VJ} = T_{VJM}$	2.4 mΩ
$V_{GT}$	$V_D = 6$ V	$T_{VJ} = 25^\circ\text{C}$ $T_{VJ} = -40^\circ\text{C}$	2.5 V 2.6 V
$I_{GT}$	$V_D = 6$ V	$T_{VJ} = 25^\circ\text{C}$ $T_{VJ} = -40^\circ\text{C}$	150 mA 200 mA
$V_{GD}$	$V_D = \frac{2}{3} V_{DRM}$	$T_{VJ} = T_{VJM}$	0.2 V
$I_{GD}$			10 mA
$I_L$	$t_p = 10 \mu\text{s}; V_D = 6$ V $I_G = 0.45$ A; $di_G/dt = 0.45$ A/ $\mu\text{s}$	$T_{VJ} = 25^\circ\text{C}$	450 mA
$I_H$	$V_D = 6$ V; $R_{GK} = \infty$ ;	$T_{VJ} = 25^\circ\text{C}$	200 mA
$t_{gd}$	$V_D = \frac{1}{2} V_{DRM}$ $I_G = 0.45$ A; $di_G/dt = 0.45$ A/ $\mu\text{s}$	$T_{VJ} = 25^\circ\text{C}$	2 $\mu\text{s}$
$t_q$	$V_D = \frac{2}{3} V_{DRM}$ $dv/dt = 20$ V/ $\mu\text{s}$ ; $-di/dt = 10$ A/ $\mu\text{s}$ $I_T = 150$ A; $V_R = 100$ V; $t_p = 200 \mu\text{s}$	$T_{VJ} = T_{VJM}$	185 $\mu\text{s}$
$Q_S$	$I_T / I_F = 50$ A; $-di/dt = 6$ A/ $\mu\text{s}$	$T_{VJ} = T_{VJM}$	170 $\mu\text{C}$
$I_{RM}$			45 A
$R_{thJC}$	per thyristor; DC current per module	} other values see Fig. 8/9	0.22 K/W
$R_{thJK}$	per thyristor; DC current per module		0.11 K/W
			0.42 K/W
			0.21 K/W
$d_s$	Creeping distance on surface		12.7 mm
$d_A$	Creepage distance in air		9.6 mm
$a$	Maximum allowable acceleration		50 m/s <sup>2</sup>

Optional accessories for modules

Coded gate/cathode twin plugs with wire length = 350 mm, gate = yellow, cathode = red

Type **ZY 200L** (L = Left for pin pair 4/5) } UL 758, style 1385,  
 Type **ZY 200R** (R = Right for pin pair 6/7) } CSA class 5851, guide 460-1-1

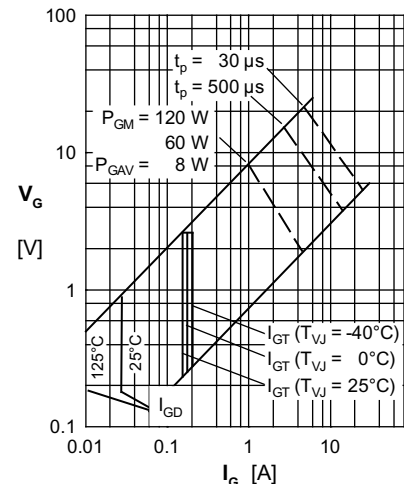

Fig. 1 Gate trigger characteristics



Fig. 2 Gate trigger delay time

Dimensions in mm (1 mm = 0.0394")

**MCC... Version 1B**

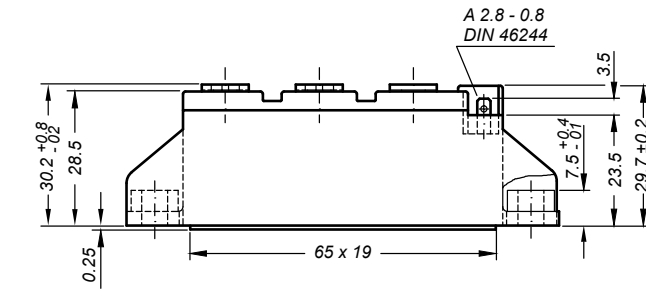

General tolerance: DIN ISO 2768 class „c“

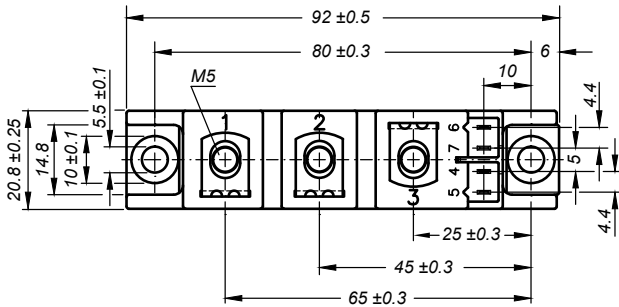

Optional accessories: Keyed gate/cathode twin plugs  
Wire length: 350 mm, gate = yellow, cathode = red  
UL 758, style 1385, CSA class 5851, guide 460-1-1  
Type ZY 200L (L = Left for pin pair 4/5)  
Type ZY 200R (R = Right for pin pair 6/7)

**MCD... Version 1B**

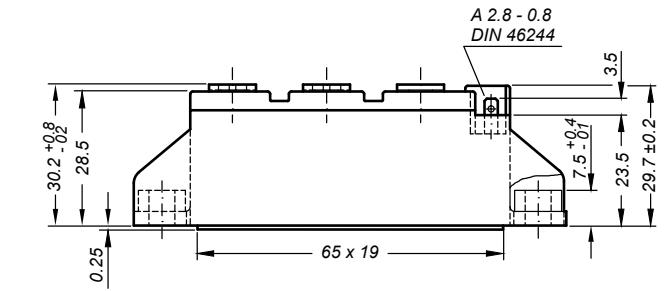

General tolerance: DIN ISO 2768 class „c“

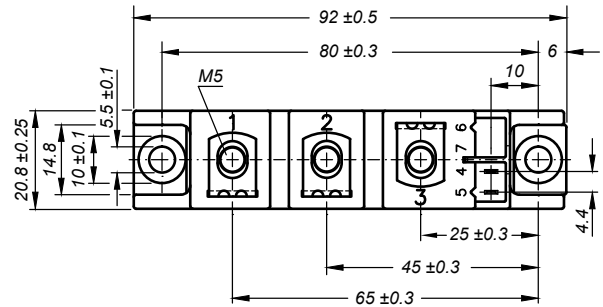

Optional accessories: Keyed gate/cathode twin plugs  
Wire length: 350 mm, gate = yellow, cathode = red  
UL 758, style 1385, CSA class 5851, guide 460-1-1  
Type ZY 200L (L = Left for pin pair 4/5)

**MCC... Version 8B**

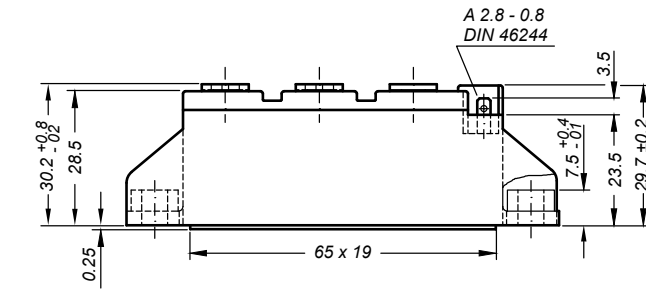

General tolerance: DIN ISO 2768 class „c“

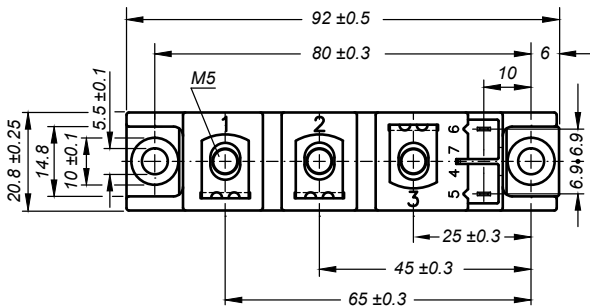

**MCD... Version 8B**

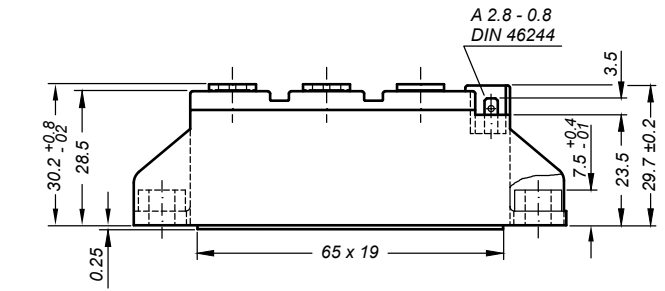

General tolerance: DIN ISO 2768 class „c“

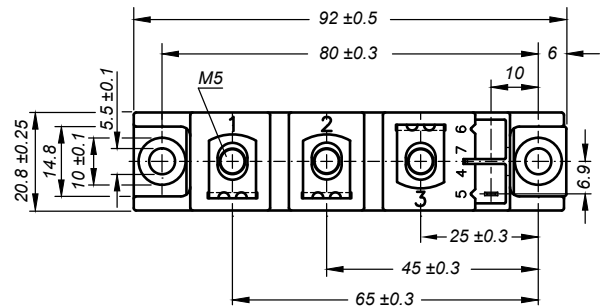



Fig. 3 Surge overload current  $I_{TSM}$ ,  
 $I_{FSM}$ : Crest value,  $t$ : duration



Fig. 4  $I^2t$  versus time (1-10 ms)



Fig. 4a Maximum forward current  
at case temperature



Fig. 5 Power dissipation versus  
on-state current & ambient  
temperature  
(per thyristor or diode)



Fig. 6 Three phase rectifier bridge:  
Power dissipation vs. direct  
output current and ambient  
temperature

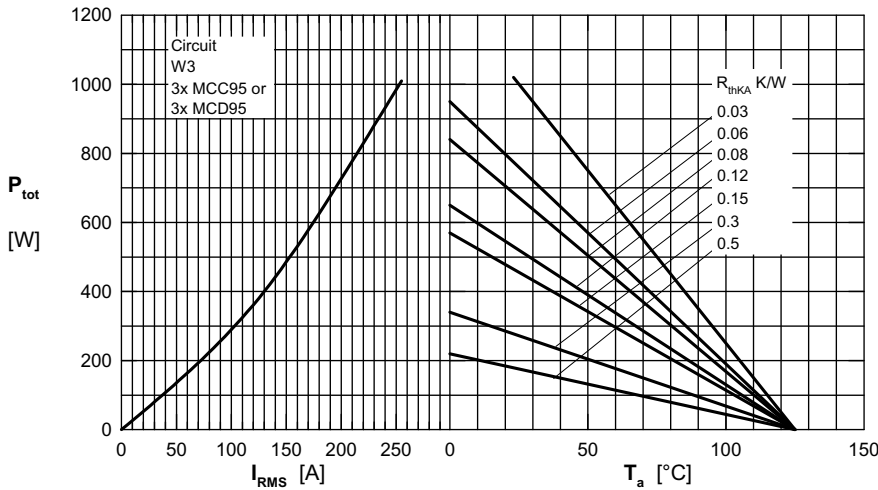

Fig. 7 Three phase AC-controller:  
Power dissipation versus RMS  
output current and ambient  
temperature

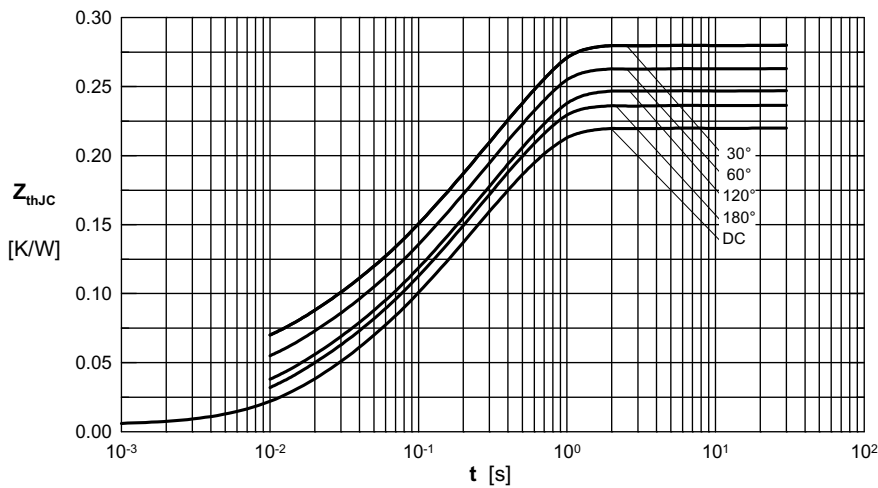

Fig. 8 Transient thermal impedance  
junction to case  
(per thyristor or diode)

$R_{thJC}$  for various conduction angles d:

d	$R_{thJC}$ (K/W)
DC	0.22
180°	0.23
120°	0.25
60°	0.27
30°	0.28

Constants for  $Z_{thJC}$  calculation:

i	$R_{thi}$ (K/W)	$t_i$ (s)
1	0.0066	0.0019
2	0.0678	0.0477
3	0.1456	0.344

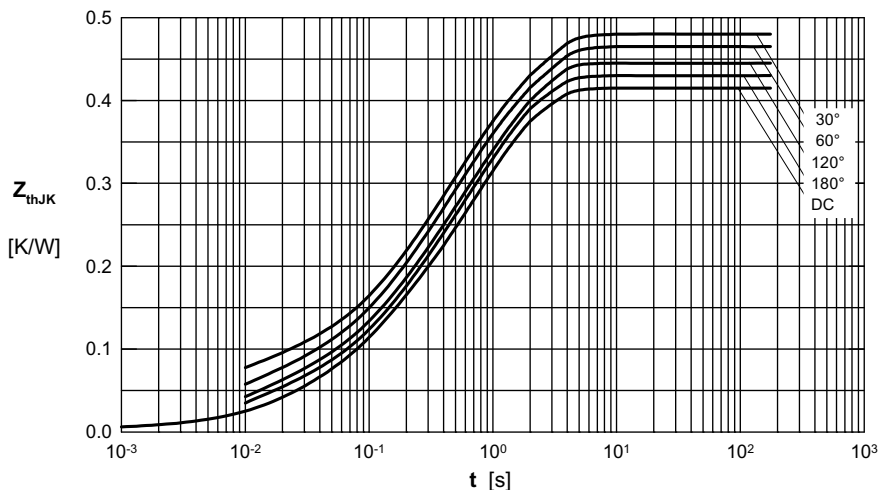

Fig. 9 Transient thermal impedance  
junction to heatsink  
(per thyristor or diode)

$R_{thJK}$  for various conduction angles d:

d	$R_{thJK}$ (K/W)
DC	0.42
180°	0.43
120°	0.45
60°	0.47
30°	0.48

Constants for  $Z_{thJK}$  calculation:

i	$R_{thi}$ (K/W)	$t_i$ (s)
1	0.0066	0.0019
2	0.0678	0.0477
3	0.1456	0.344
4	0.2	1.32