

Xinger®

Ultra Low Profile 0805 Balun 50Ω to 100Ω Balanced



Description

The BD1722J50100AHF is a low profile sub-miniature balanced to unbalanced transformer designed for differential inputs and output locations on next generation wireless chipsets in an easy to use surface mount package covering the DCS, PCS, UMTS and CDMA frequencies. The BD1722J50100AHF is ideal for high volume manufacturing and is higher performance than traditional ceramic, and lumped element baluns. The BD1722J50100AHF has an unbalanced port impedance of 50Ω and a 100Ω balanced port impedance. This transformation enables single ended signals to be applied to differential ports on modern semiconductors. The output ports have equal amplitude (-3dB) with 180 degree phase differential. The BD1722J50100AHF is available on tape and reel for pick and place high volume manufacturing.

Detailed Electrical Specifications: Specifications subject to change without notice.

Features:	Parameter	ROOM (25°C)			Unit
		Min.	Typ.	Max	
<ul style="list-style-type: none"> • 1700 – 2200 MHz • 0.7mm Height Profile • 50 Ohm to 2 x 50 Ohm • DCS/PCS/UMTS/CDMA • Low Insertion Loss • Input to Output DC Isolation • Surface Mountable • Tape & Reel • Non-conductive Surface • RoHS Compliant • Halogen Free 	Frequency	1700		2200	MHz
	Unbalanced Port Impedance		50		Ω
	Balanced Port Impedance		100		Ω
	Return Loss	9	13		dB
	Insertion Loss*		0.9	1.2	dB
	Amplitude Balance		0.4	1.2	dB
	Phase Balance		4	6	Degrees
	CMRR		29		dB
	Power Handling			2	Watts
	Operating Temperature		-55		+85

* Insertion Loss stated at room temperature (Insertion Loss is approximately 0.1 dB higher at +85 °C)

Outline Drawing

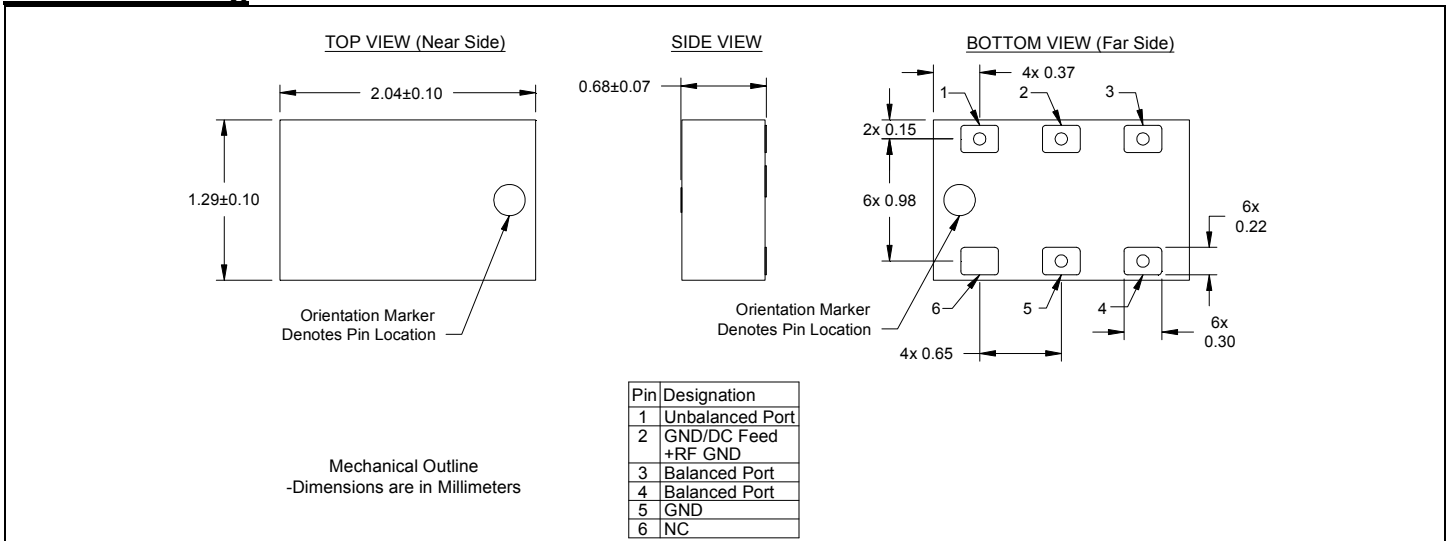

Typical Broadband Performance: 500 MHz. to 8.5 GHz.

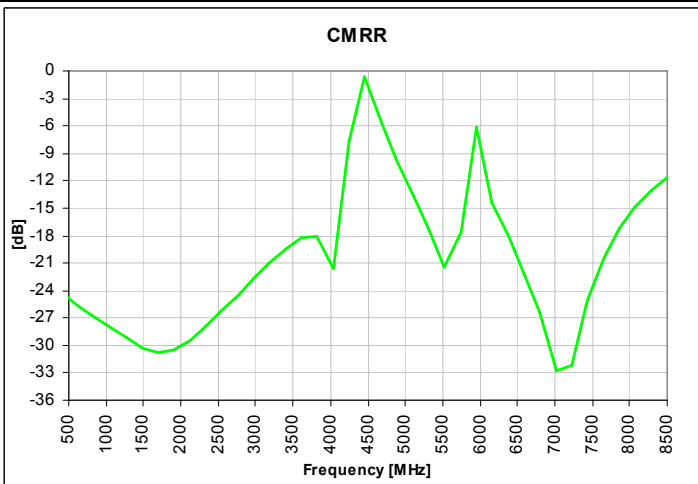
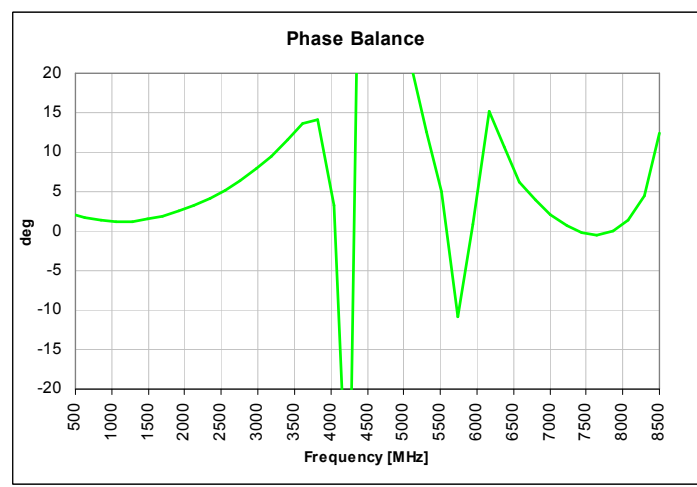
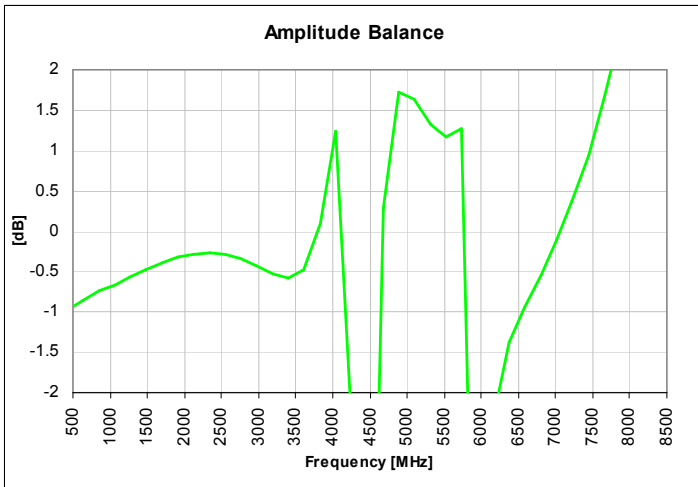
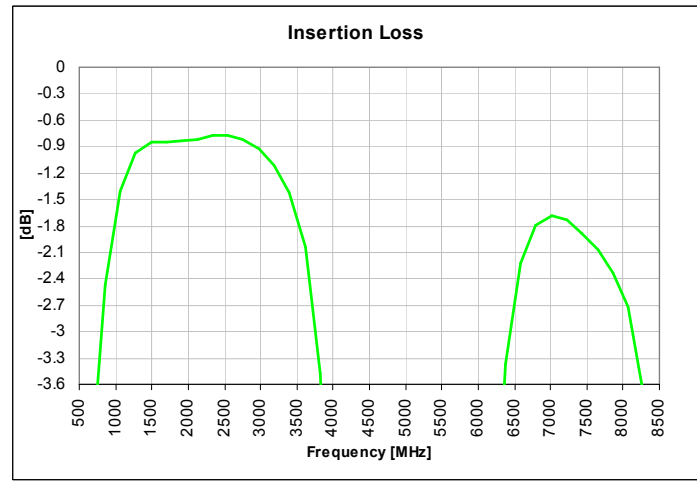
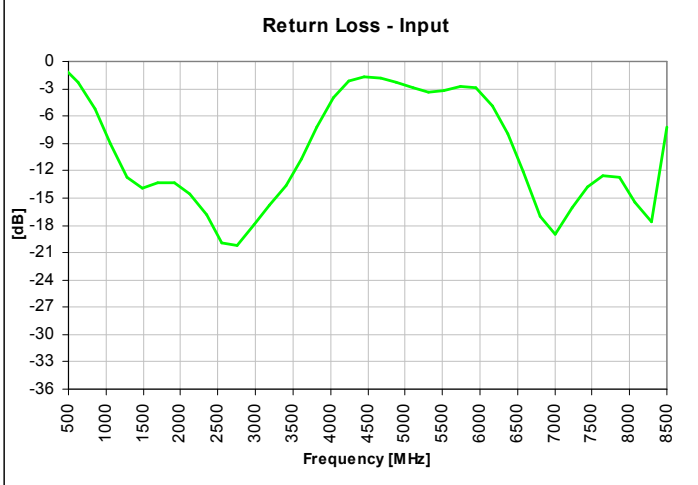

Typical Performance: 1600 MHz. to 2300 MHz.

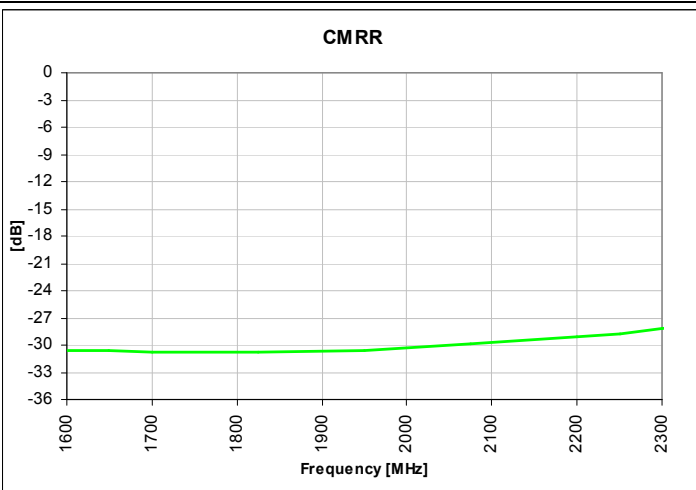
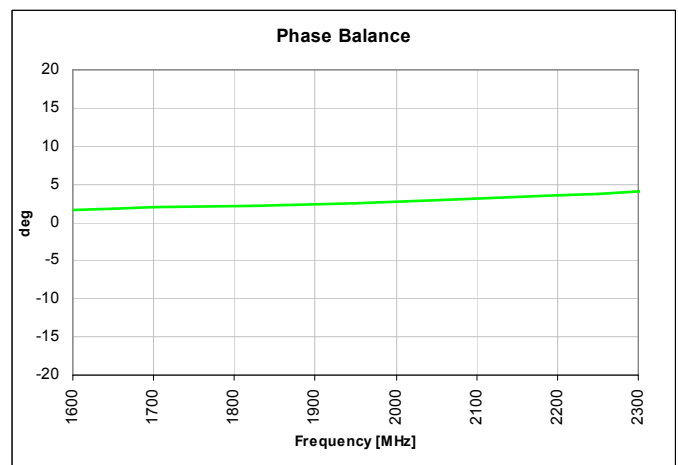
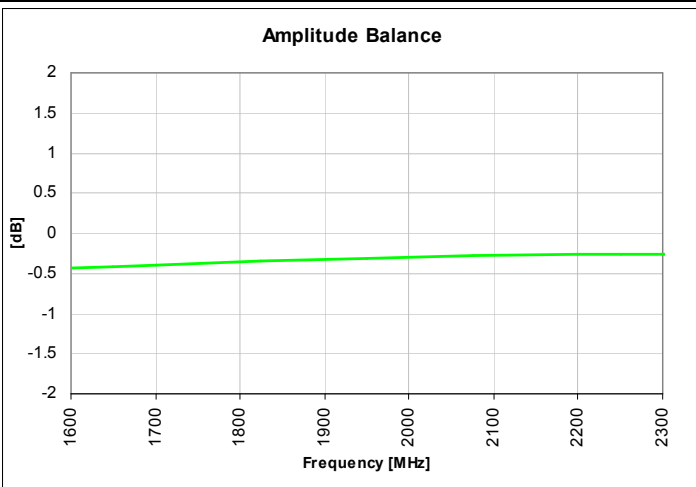
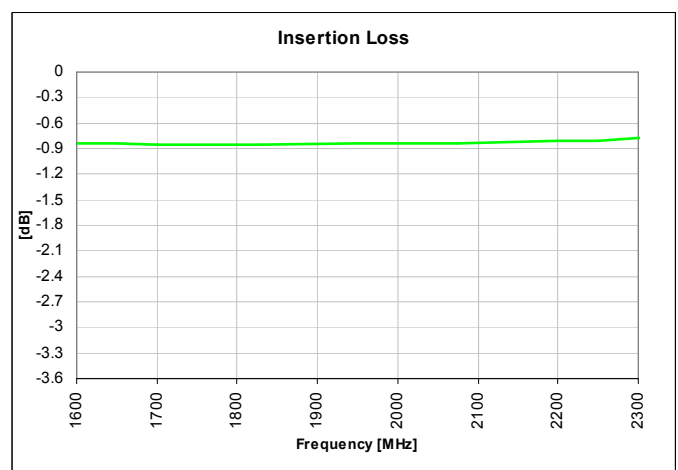
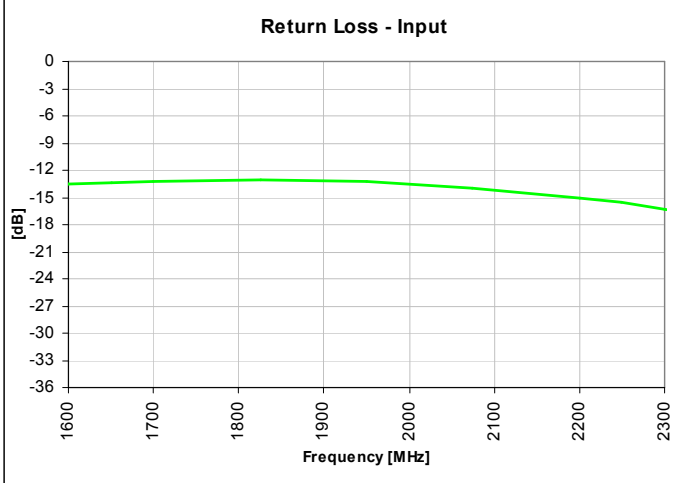



Mounting Configuration:

In order for Xinger surface mount components to work optimally, the proper impedance transmission lines must be used to connect to the RF ports. If this condition is not satisfied, insertion loss, Isolation and VSWR may not meet published specifications.

All of the Xinger components are constructed from ceramic filled PTFE composites which possess excellent electrical and mechanical stability having X and Y thermal coefficient of expansion (CTE) of 17 ppm/°C.

An example of the PCB footprint used in the testing of these parts is shown below. An example of a DC-biased footprint is also shown below. In specific designs, the transmission line widths need to be adjusted to the unique dielectric coefficients and thicknesses as well as varying pick and place equipment tolerances.



No Bias Footprint

-  Circuit Pattern
-  Footprint Pad (s)
-  Solder Resist

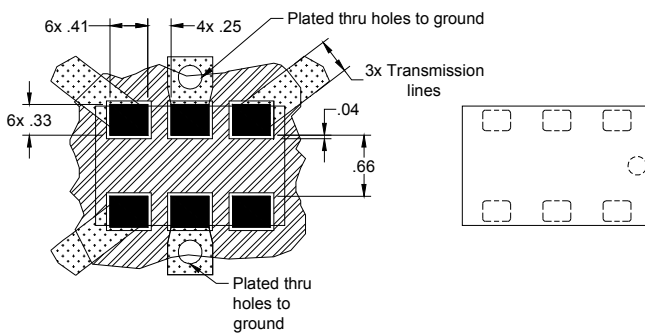
Dimensions are in Millimeters
Mounting Footprint



DC Bias Footprint

-  Circuit Pattern
-  Footprint Pad (s)
-  Solder Resist

Dimensions are in Millimeters
Mounting Footprint

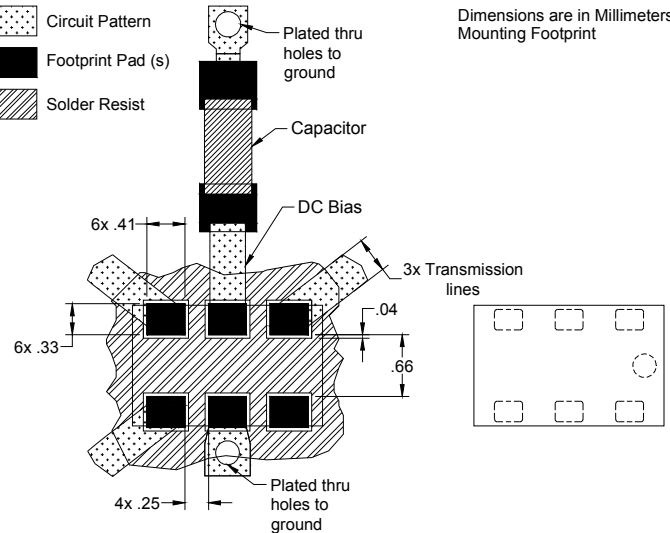

Packaging and Ordering Information

Parts are available in reel and are packaged per EIA 481-2. Parts are oriented in tape and reel as shown below. Minimum order quantities are 4000 per reel. See Model Numbers below for further ordering information.

