

V-Series Switch

Product Highlights:

- ♦ Maximum sealing protection with dual seals around lamps and rocker stem certified to IP66 & IP68. Optional panel seals for additional protection.
- ♦ Silver plated butt contact mechanism provides 50 to 100 thousand electrical cycles and a variety of different electrical ratings.
- ♦ Roller pin mechanism does not require lubricants and allows the switch to withstand extreme temperatures.
- ♦ The switch base accommodates up to 10 terminals and a large variety of switch and lighting circuits.
- ♦ The multi-step mounting wings provide a secure fit for panel thicknesses of 0.032" thru 0.250" in an industry standard 0.830" x 1.450" mounting hole.
- ♦ The switch connector allows the user to preload FQC terminals for easy assembly to switch base.
- ♦ Numerous choices of removable rockers allow for style change without having to retest or re-qualify the switch base.
- ♦ Illumination options are endless with bar, oval, and square lenses available in choices of incandescent, neon and a wide variety of LEDs including superbrite, megabrite, flashing and bicolor lighting.
- ♦ Available with a variety of complimentary mounting panels, hole plugs, illuminated indicators and boots to accommodate most any design need.



CONTURA III



CONTURA II



CONTURA V



CONTURA VII

Carling Technologies' fully sealed V-Series Contura switches are well known for their cutting edge design, high quality, maximum performance and unmatched reliability. These switches are a staple in the marine and transportation industries and have passed a range of environmental, corrosion, temperature, vibration, shock and sealing tests including MIL Std 202F, MIL Std 810C, UL 1500, ISO 8846, IEC 60529 and BS 5490 among others, making them one of the most rugged and reliable switches ever manufactured.



Carling Technologies®

Innovative Designs. Powerful Solutions.

Innovative Designs. Powerful Solutions.

Carling Technologies, Inc.
60 Johnson Avenue • Plainville, CT 06062-1177
Phone: (860) 793-9281 • Fax: (860) 793-9231
Email: sales@carlingtech.com • www.carlingtech.com

V-Series Switch

DESIGN FEATURES

MAXIMUM DESIGN OPTIONS WITH MINIMUM INVENTORIES

Panel redesign is a snap, requiring no tooling change, with our removable interchangeable actuators. A unique balance between aesthetics and functionality.

SEALS OUT WATER, DUST AND DEBRIS

Dual seal protection locks out elements. Certified to IP66/IP68 for front panel components.

CLEAN CONNECTIONS

Offered in both eight and ten terminal base options. AMP & Packard compatible connectors available.

SILVER PLATED BUTT

Contact mechanism provides 50 to 100 thousand electrical cycles and a variety of different electrical ratings.

WITHSTANDS EXTREME TEMPERATURES

Roller pin mechanism eliminates the need for lubricants. Enables switch to withstand -40°C to +85°C temperatures.

MULTIPLE LIGHTING OPTIONS

Incandescent lamps & LED lighting. Our LED illumination is offered in a wide array of light intensities, colors, as well as dual level, tri-color, and flashing options.

OPTIONAL PANEL SEAL

Prevents water/dust egress behind panel.

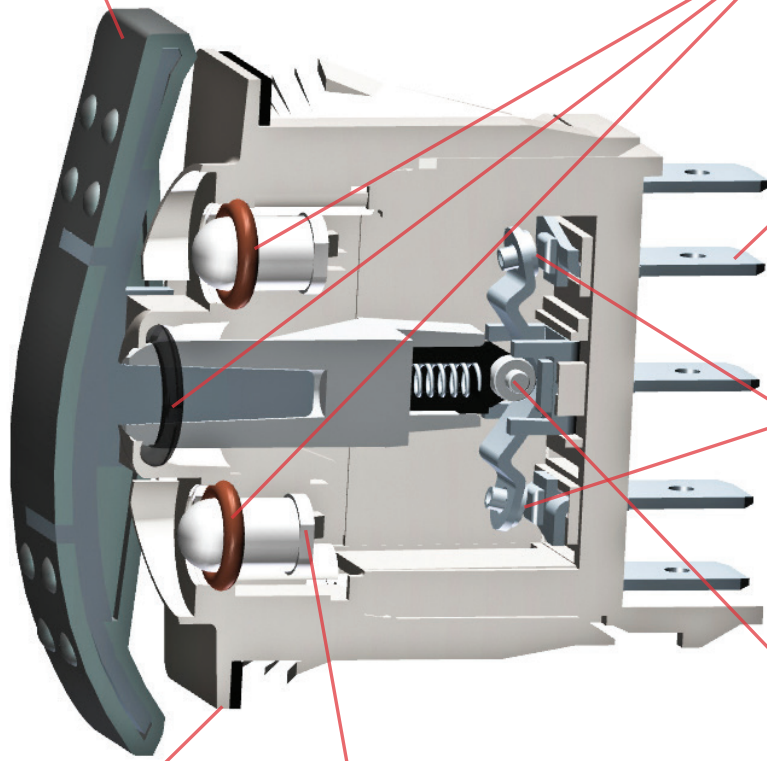



Contura II & III

The Contura II & III actuators are constructed of thermoplastic polycarbonate and are offered with a hard nylon overlay or a "soft-touch" elastomer overlay. These models incorporate aesthetic designs on the top and bottom of the rocker featuring two rows of raised "bumps" on the Contura II and three "indented" lines on the Contura III.



Contura X

The raised bracket/bezel on the Contura X helps prevent inadvertent actuation of the rocker, as well as preventing debris from being trapped under the actuator. This curved rocker style is available with a variety of lenses and legends.



Contura IV

The Contura IV's "Shape to create a Shape" actuator works with the curves, contours & advanced styling of the latest panel designs, flowing with these advanced curves & radii. This actuator style fits on the Contura flush bracket/bezel.



Contura XI

The raised bracket/bezel on the Contura XI helps prevent inadvertent actuation of the rocker, as well as preventing debris from being trapped under the actuator. This convex style rocker is available with a wide variety of lenses and legends.



Contura V

The symmetrically curved Contura V actuator provides the perfect complement to the Contura IV's "Shape to create a Shape" design concept. With its flush style mounting bracket, Contura V can be mounted in between two Contura IV's, by itself, or in groups.



Contura XII

The Contura XII version features a paddle style actuator with the raised bracket/bezel of Contura X and XI. The contoured handle design provides intuitive recognition and ease of operation and is available with all Contura X and XI lens and legend offerings.



Contura VI (WAVE)

The Contura VI WAVE sealed rocker switches, when used in a row, create an uniquely appealing "wave" design on your panel. A variety of colors and finishes are available for both rocker and wave insert. Contura VI features bar and oval lenses.



Illuminated Indicator

The Illuminated Indicator is offered with removable/ replaceable lamps and Contura II, III, V, or X styling. Illumination alerts the operator of essential system functions or malfunctions like: oil pressure, high temperature, fluid levels, parking brake, or general system malfunction.



Contura VII

Contura VII featuring gently curved corners and edges assuring compatibility with most any panel design. Intuitive feel is maximized by the use of 2 embossed circular pads located at opposite ends of the rocker. Any combination of Bar or Oval style lenses can be located in the pads providing a truly unique look, exclusive to Contura VII.

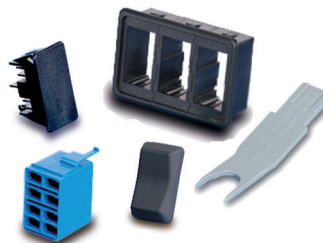

V-Series Accessories/Options

Carling Technologies also offers many V-Series accessories including connectors, mounting panels, hole plugs, panel seals, and actuator removal tools.

Electrical

| | |
|----------------------------|--|
| Contact Rating | 4VA @ 28VDC (MAX) resistive 15 amps, 125VAC 10 amps, 250VAC 1/2 HP 125-250VAC 20 amps, 4-14VDC 15 amps, 15-28VDC 10A, 14VT 6A, 125VAC L |
| Dielectric Strength | 1500 Volts RMS |
| Insulation Resistance | 50 Megohms |
| Initial Contact Resistance | 10 milliohms max. @ 4VDC |
| Life | 50,000- 100,000 cycles circuit dependent |
| Contacts | Silver alloy, silver tin-oxide, fine silver |
| Terminals | Brass or copper/silver plate 1/4" (6.3mm) Quick Connect terminations standard. Solder lug, Wire Lead |

Mechanical

| | |
|-----------|---|
| Endurance | 150,000 cycles minimum circuit dependent |
|-----------|---|

Physical

| | |
|--|---|
| Lighted | Incandescent - rated 10,000 hours Neon - rated 25,000 hours LED - rated 100,000 hours 1/2 life (LED is internally ballasted for voltages to 24VDC) |
| Seals | Internal |
| Base | Optional external gasket panel seal Polyester blend rated to 125°C with a UL flammability rating of 94V0. |
| Contura II, III, IV, V, VI Actuator | Hard Surface: Basic actuator structure molded of thermoplastic polycarbonate with a hard Nylon 66 thermoplastic surface overlay. Soft Surface: Basic actuator structure molded of thermoplastic polycarbonate with an elastomer overlay. |
| Contura X, XI, XII Actuator, VP Lens | Nylon 66 Reinforced rated to 105°C Polycarbonate rated at 100°C |

Actuator Travel (Angular Displacement)

| | |
|-------------|----------------|
| 2 position | 18° |
| 3 positions | 9° from center |

Mounting Specifications

| | |
|-----------------------|--|
| Panel Thickness Range | |
| # of gaskets | Acceptable Panel Thickness |
| 0 | .030 to .250 (.76mm to 6.35mm) |
| 1 | .030 to .109 & .147 to .157 (.76 to 2.77mm & 3.73 to 3.98mm) |
| Recommended: | No gasket with panel thickness of .032, .062, .093, .125, .187 or .250 |

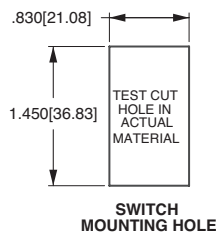

Agency Certifications



Environmental

| | |
|-----------------------|---|
| Environmental | Sealed version: IP68, in accordance with IEC 60529, BS 5490, DIN 40050 & NFC 20 010. This rating applies to front panel components of the actual switch only, and signifies protection against dust and the prolonged effects of immersion under pressure. The standard test for immersion under pressure requires submersion under one meter of water for 30 minutes. The V-Series switch has exceeded these parameters, having been actuated and illuminated during submersion. |
| Corrosion | Flowing Mixed Gas (FMG) Class III 3 year accelerated exposure per ASTM B-827, B-845 Silver and gold contacts |
| Operating Temperature | -40°C to + 85°C |
| Vibration 1 | Per Mil-Std 202F, Method 204D Test Condition A 0.06 DA or 10G's 10-500 Hz. Tested with VCH connector. Test criteria - No loss of circuit during test and pre and post test contact resistance. |
| Vibration 2 | Resonance search 24-50 Hz 0.40 DA 50-2000 ±10 G's peak Results Horizontal Axis 3-5 G's max. Random 24 Hz 0.06 PSD-Gsq/Hz 60 Hz 0.50 100 Hz 0.50 200 Hz 0.025 2000 Hz 0.025 No loss of circuit during test; <10µ seconds chatter. |
| Shock | Per Mil-Std 202F, Method 213B, Test Condition K @ 30G's. Tested with VCH connector. Test criteria - No loss of circuit during test, pre and post test contact resistance. |
| Salt Spray | Per Mil-Std 202F, Method 101D, Test Condition A, 48 Hrs. Sealed version only. |
| Dust | Per Mil-Std 810C, Method 510.2 Air Velocity 300 ±200 Feet/Min, Test Duration 16 Hrs. |
| Thermal Shock | Per Mil-Std 202F, Method 107F, Test Cond. A, -55°C to 85°C. Test criteria - pre and post test contact resistance |
| Moisture Resistance | Per Mil-Std 202F, Method 106F, Test Criteria - pre and post test contact resistance |
| Ignition Protection | All Contura switches with sealed construction meet the requirements of UL1500/ISO8846 for ignition protection, in addition to conformance with EC directive 94/25/EC for marine products. |

Dimensional Specifications: in. [mm]

CONTURA II STYLE

SHOWN WITH SQUARE LENS

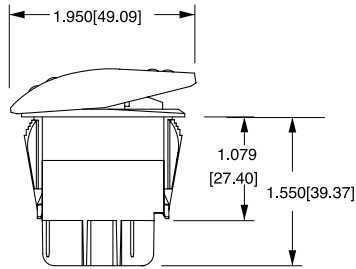
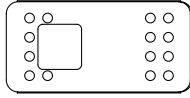

8 TERMINAL BASE W/BARRIERS

CONTURA III STYLE

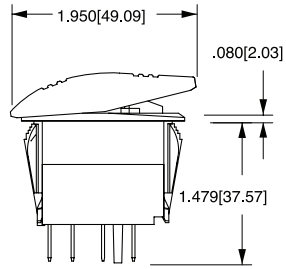
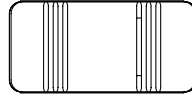

8 TERMINAL BASE W/O BARRIERS

CONTURA IV STYLE

SHOWN WITH BAR LENS

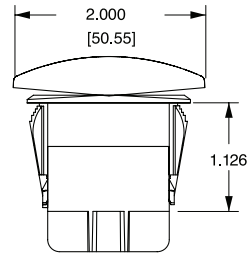
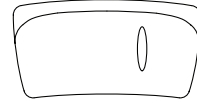

10 TERMINAL BASE W/BARRIERS

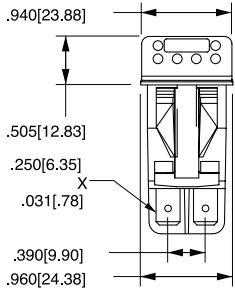

8 TERMINAL BASE W/BARRIERS

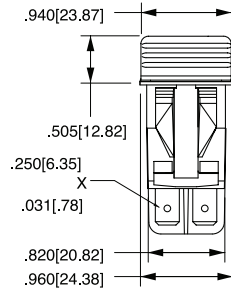

10 TERMINAL BASE W/BARRIERS

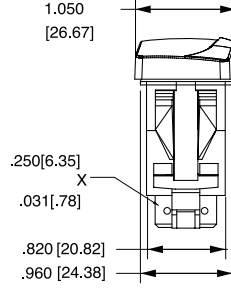

10 TERMINAL BASE W/O BARRIERS

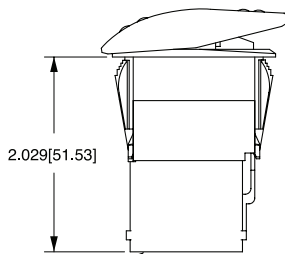

SWITCH SHOWN WITH VCH CONNECTOR 8 TERMINAL

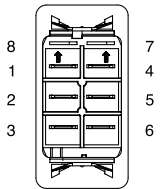

BOTTOM VIEW TERMINAL ARRANGEMENT 8 TERMINAL BASE

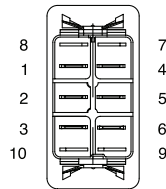

BOTTOM VIEW TERMINAL ARRANGEMENT 10 TERMINAL BASE

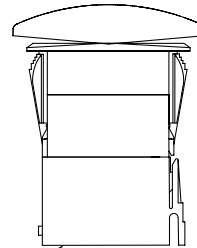

SWITCH SHOWN WITH VC1 CONNECTOR 10 TERMINAL

Dimensional Specifications: in. [mm]

CONTURA V

SHOWN WITH
BAR LENS

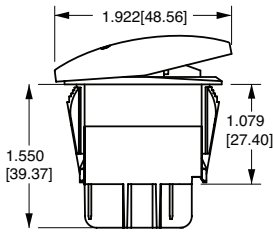
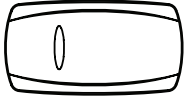

**8 TERMINAL BASE
W/BARRIERS**

CONTURA V

SHOWN WITH
LOW PROFILE LOCK

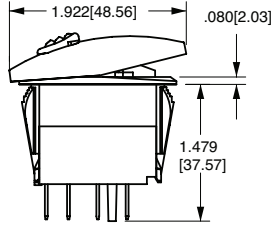
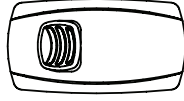

**8 TERMINAL BASE
W/O BARRIERS**

CONTURA VI

SHOWN WITH OVAL
LENS

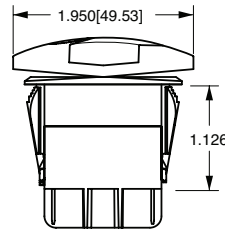
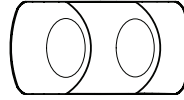

**10 TERMINAL BASE
W/BARRIER AND
LAMP TERMINAL**

CONTURA VII

SHOWN WITH LARGE LENS
AND BAR LENS

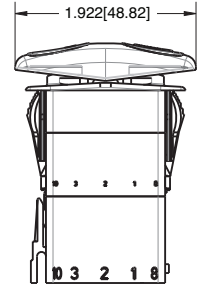
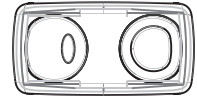

**10 TERMINAL BASE
W/O BARRIERS**

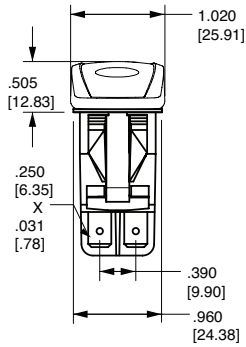

**8 TERMINAL BASE
W/BARRIERS**

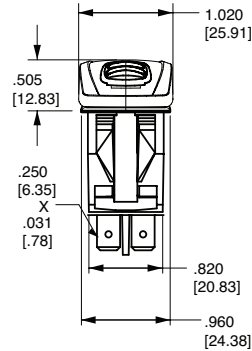

**8 TERMINAL BASE
W/O BARRIERS**

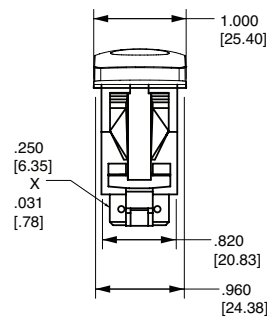

**10 TERMINAL BASE
W/O BARRIERS**

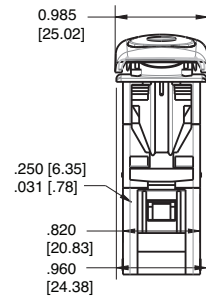

**10 TERMINAL BASE
W/O BARRIERS**

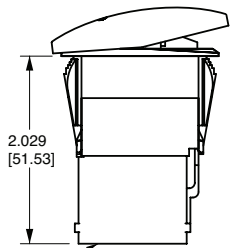

SWITCH SHOWN WITH
VCH CONNECTOR 8
TERMINAL

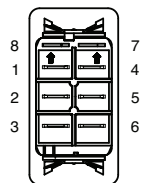

**BOTTOM VIEW
TERMINAL
ARRANGEMENT
8 TERMINAL BASE**

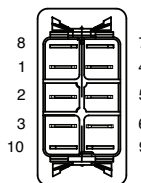

**BOTTOM VIEW
TERMINAL
ARRANGEMENT
10 TERMINAL BASE**

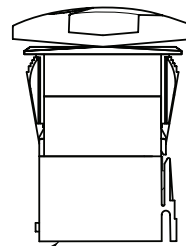

SWITCH SHOWN WITH
VC1 CONNECTOR 10
TERMINAL

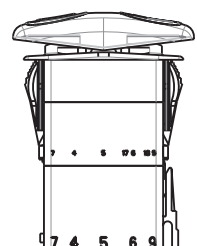

SWITCH SHOWN WITH VC1
CONNECTOR 10
TERMINAL

Dimensional Specifications: in. [mm]

CONTURA STOLE
CONTURA STOLE

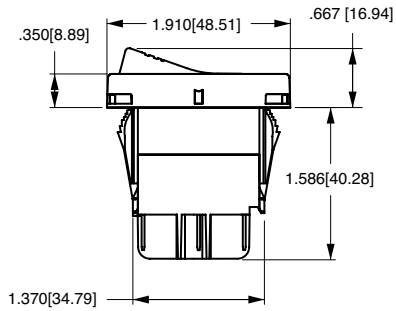
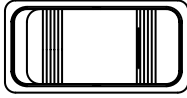

**8 TERMINAL BASE
 W/BARRIERS**

CONTURA STOLE
CONTURA STOLE

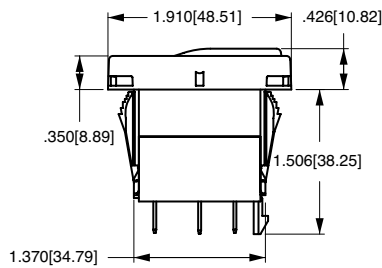
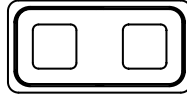

**10 TERMINAL BASE
 W/O BARRIERS**

CONTURA STOLE
CONTURA STOLE

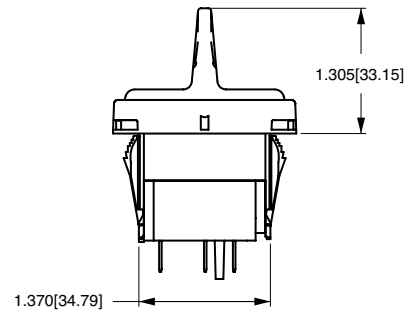
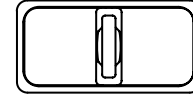

**8 TERMINAL BASE
 W/O BARRIERS**

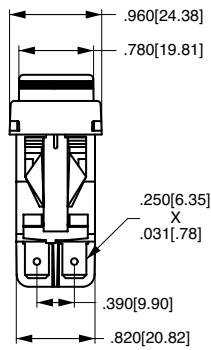

**8 TERMINAL BASE
 W/BARRIERS**

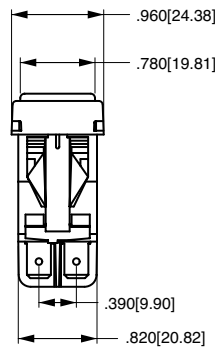

**10 TERMINAL BASE
 W/BARRIERS**

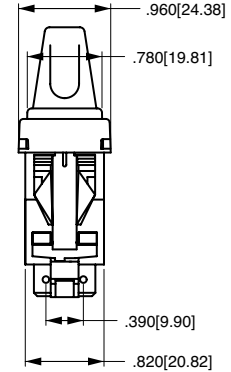

**10 TERMINAL
 BASE
 W/O BARRIERS**

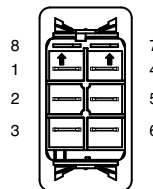
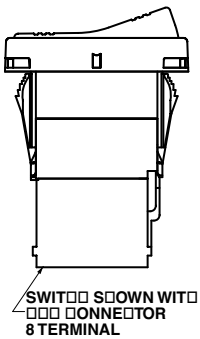

**BOTTOM VIEW
 TERMINAL
 ARRANGEMENT
 8 TERMINAL BASE**

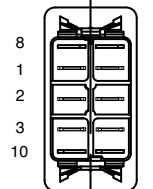

**BOTTOM VIEW
 TERMINAL
 ARRANGEMENT
 10 TERMINAL BASE**

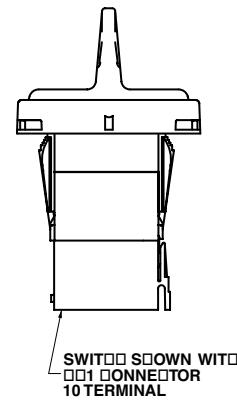

| CIRCUIT | CIRCUIT DIAGRAM |
|---------|-----------------|
| 1 | |
| 2 | |
| 3 | |
| 4 | |
| 5 | |
| 6 | |
| 7 | |
| 8 | |

| CIRCUIT | CIRCUIT DIAGRAM |
|---------|-----------------|
| A | |
| B | |
| C | |
| D | |
| E | |
| F | |
| G | |
| H | |

| CIRCUIT | CIRCUIT DIAGRAM |
|---------|-----------------|
| J | |
| K | |
| L | |
| M | |
| R | |
| S | |

| SYMBOL LEGEND | |
|---------------|---|
| SYM. | DEFINITION |
| | DESIGNATES TERMINALS AND CONTACTS |
| | DESIGNATES LAMP LOCATION |
| | DESIGNATES MAINTAINED CIRCUITS |
| | DESIGNATES OTHER POSITION |
| | DESIGNATES MOMENTARY CIRCUITS |
| | DESIGNATES TWO POSITION CONNECTION |
| | DESIGNATES EXTERNAL JUMPER PROVIDED BY CUSTOMER |

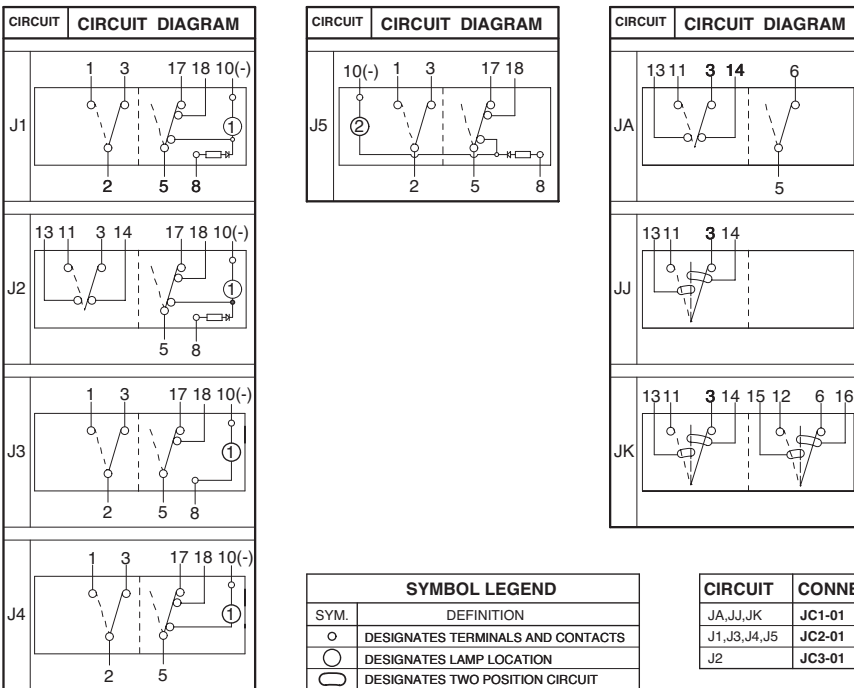
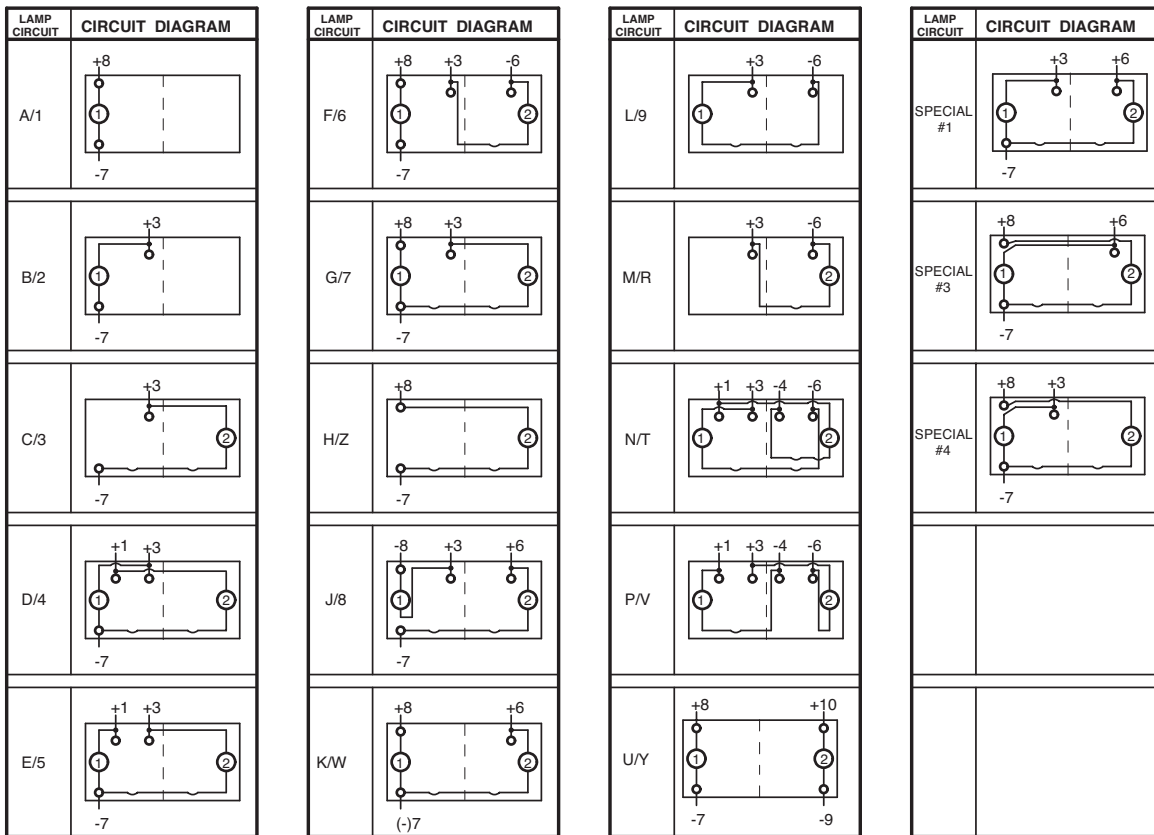

NOTE:
J circuits are available for all non-locking V-Series styles. Consult factory for p/n details.

V 1 D A B T O B — A R B 00 — 0 00

1 Series 2 Circuit 3 Rating 4 Termination Illumination Lamp 5 Lamp 6 Lamp 7 Lamp 8 Bracket 9 Actuator 10 Lens 11 Color 12 Legend 13 Legend Orientation 14 Actuator Lens Legend

1 SERIES
V

2 CIRCUIT
Terminal Connections as viewed from bottom of switch:
8 terminal 10 terminal
1 - -7 8 - -7
2 - -4 1 - -4
3 - -5 2 - -5
4 - -6 3 - -6
5 - -9 10 - -9

() - momentary
SP - single pole - uses terminals 1, 2 & 3.
DP - double pole uses terminals 1, 2, 3, 4, 5 & 6.
Terminals 7, 8, 9 & 10 for lamp circuit only.

Position:

| | 1 | 2 | 3 |
|----|--------------|---------------------|--------------|
| SP | 2 & 3, 5 & 6 | Connected Terminals | 1 & 2, 4 & 5 |
| 1 | ON | NONE | OFF |
| 2 | (ON) | NONE | OFF |
| 3 | ON | NONE | (OFF) |
| 4 | ON | NONE | ON |
| 5 | ON | NONE | (ON) |
| 6 | ON | NONE | ON |
| 7 | ON | OFF | ON |
| 8 | ON | OFF | (ON) |
| 9 | (ON) | OFF | (ON) |

SPECIAL CIRCUITS

| | | | |
|----|----------------|--------------|-------|
| H* | 2 & 3 | 2 & 3, 5 & 4 | 5 & 4 |
| G* | 2 & 3, 5 & 6 | 2 & 3 | OFF |
| S | 2 & 3, 5 & 6 | 2 & 3 | 1 & 2 |
| M* | (2 & 3, 5 & 6) | 2 & 3 | OFF |
| R | (2 & 3, 5 & 6) | 2 & 3 | 1 & 2 |
| E* | 5 & 6 | 5 & 3 | 5 & 1 |

*Jumper between terminals 2 & 5 for circuits H, G, & M are specified in selection 4.
External jumper between terminals 2 & 4 for circuit E are provided by customer. Circuit E may be used for SP OFF-ON-ON circuit.

3 RATING³

1 .4VA @ 28VDC Resistive
B 15A 24V
C 20A 18V
D 20A 12V
E 20A 14V, 10A 14VT (circuit 1, 4, A & D only)
F 10A 14V, 6A 14VT (circuit G only)
M .4VA/20A 12V
N .4VA/15A 24V

4 TERMINATION/BASE STYLE

| 8 term | 10 term | Termination | Jumper |
|--------|---------|-----------------------------|-------------|
| 1 | 2 | .250 TAB (QC) no barriers | No |
| A | B | .250 TAB (QC) with barriers | No |
| J | K | .250 TAB (QC) no barriers | Yes T2 to 5 |
| 3 | 4 | Solder Lug no barriers | No |
| C | D | Solder Lug | No |
| 5 | 6 | Wire Leads no barriers | No |
| E | F | Wire Leads | No |

Note: Codes J & K for circuits H, G & M.

5 ILLUMINATION & SWITCH SEALING
Lamp #1: above terminals 1 & 4 end of switch.; Lamp #2 above terminals 3 & 6 end of switch. Positive (+) and negative (-) symbols apply to LED lamps only

| Sealed | Unsealed | Lamps | Actuator Lens position when Illuminated | Lamp wired to Terminals |
|--------|----------|-------|---|-------------------------|
| S | 0 | NONE | | |
| A | 1 | #1 | Independent | 8+ 7- |
| B | 2 | #1 | Down | 3+ 7- |
| C | 3 | #2 | Up | 3+ 7- |
| D | 4 | #1 | Down | 3+ 7- |
| E | 5 | #1 | Down | 1+ 7- |
| F | 6 | #1 | Up | 3+ 7- |
| G | 7 | #1 | Independent | 8+ 7- |
| H | Z | #2 | Up | 3+ 7- |
| U | Y | #1 | Independent | 8+ 7- |
| | | #2 | Independent | 10+ 9- |

Selections for Single Pole Switches Only:

| | | | | |
|---|---|----|-------------|-------|
| J | 8 | #1 | Down | 3+ 8- |
| K | W | #1 | Independent | 8+ 7- |
| | | #2 | Independent | 8+ 7- |
| | | #2 | Independent | 6+ 7- |

Selections for Double Pole Switches Only:

| | | | | |
|---|---|----|------|-------|
| L | 9 | #1 | Down | 3+ 6- |
| M | R | #2 | Up | 3+ 6- |
| N | T | #1 | Down | 3+ 6- |
| P | V | #1 | Down | 1+ 4- |
| | | #2 | Up | 1+ 4- |

6,7 LAMP (SAME CODING FOR BOTH SELECTIONS)
Selection 6: above terminals 1 & 4; Selection 7: above terminals 3 & 6

| | | | | | | |
|-------------------|---|----------|----------|-------------------------|-----------------------|-----------------------|
| No lamp | 0 | 1 125VAC | 2 250VAC | 6 12V superbright Green | 7 18V superbright Red | 8 24V superbright Red |
| Neon | 1 | 4 3V | 5 6V | | | |
| Incandescent LED* | | Red | Amber | | | |
| 2VDC | A | L | F | | | |
| 6VDC | B | M | G | | | |
| 12VDC | C | N | H | | | |
| 24VDC | D | P | J | | | |

* Consult factory for "daylight bright" LED options. Typical current draw for LED is 20ma.

8 FLUSH BRACKET COLOR¹, PANEL SEAL

| | | | |
|----------|-------|-------|------|
| No Seal | Black | White | Gray |
| One Seal | B | W | G |
| | C | Y | H |

9 ACTUATOR

| | | | |
|-------------|---|--|--|
| No Actuator | 0 | | |
| Contura II | A | | |
| Contura III | B | | |
| | C | | |
| | D | | |

Actuator orientation above terminals: 3,6 1,4

10 LENS

| | | | | |
|-----------------|-------------|-------|-----|------|
| 0 - No Actuator | Z - No Lens | Green | Red | Blue |
| Clear | White | Amber | | |
| 1 | 6 | B | G | M |
| 2 | 7 | C | H | N |
| 3 | 8 | D | J | P |
| 4 | 9 | E | K | R |
| 5 | A | F | L | S |
| | | | | W |
| | | | | Y |

Square lens options available only for Contura II:
4 9 E K L R W
5 A F L S Y

Lens color for LEDs must be clear, white, or match color of LED.
Green or blue lenses are not recommended with Neon lamps.

11 ACTUATOR COLOR¹ AND TEXTURE

| | | | | |
|-----------------|-------|------|-----|-------|
| 0 - No Actuator | Black | Gray | Red | White |
| Soft Surface | B | G | R | W |
| Hard Surface | C | H | S | Y |

12 ACTUATOR LENS OR BODY LEGENDS²

| | | | |
|-------|--------|-------|-------|
| 11 ON | 12 OFF | 13 I | 14 O |
| OFF | ON | O | I |
| 15 OO | 16 OO | 17 OI | 18 IO |
| F N | F N | | |
| F | F | | |

For additional legend options & codes, visit us at www.carlingtech.com.

13 LEGEND ORIENTATION

0 No legend (used with codes 11-18 in selection 12)
1 Orientation 1
2 Orientation 2
3 Orientation 3
4 Orientation 4

14 ACTUATOR LENS LEGEND

00 No legend this location / no actuator (used with codes 11-18 in selection 12) Selection 14 required when switch requires two legends. If the two legends consist of one lens and one body legend, lens legend must be specified in selection 12; body legend specified in selection 14.
For legend options & codes, visit us at www.carlingtech.com.

- Notes:
- Consult factory to verify horsepower rating for your particular circuit choice.
 - Custom colors are available. Consult factory.
 - Body legends not available on Soft surface actuators; White imprinting is standard on black actuators; Black imprinting is standard on white, red and gray actuators; Custom colors are available, consult factory.
 - Additional ratings available. See page 20.
 - Contura II available with two square lenses. Consult factory for details.

| | | | | | | | | | | | | | | |
|----------|-----------|----------|---------------|----------------|--------|--------|-----------|---|------------|---------|-------------|-----------|---|-----------------------|
| V | 1 | D | A | S | W | O | B | — | A | Z | E | 00 | — | 0 |
| 1 Series | 2 Circuit | 3 Rating | 4 Termination | 5 Illumination | 6 Lock | 7 Lamp | 8 Bracket | | 9 Actuator | 10 Lens | 11 Function | 12 Legend | | 13 Legend Orientation |

1 SERIES
V

2 CIRCUIT
Terminal Connections as viewed from bottom of switch:

| | | |
|------------|-------------|--|
| 8 terminal | 10 terminal | () - momentary |
| 8 - -7 | 8 - -7 | SP - single pole - uses terminals 1, 2 & 3. |
| 1 - -4 | 1 - -4 | DP - double pole uses terminals 1, 2, 3, 4, 5 & 6. |
| 2 - -5 | 2 - -5 | Terminals 7, 8, 9 & 10 for lamp circuit only. |
| 3 - -6 | 3 - -6 | |
| | 10 - -9 | |

Position:

| | | | |
|----|--------------|---------------------|--------------|
| | 1 | 2 | 3 |
| SP | 2 & 3, 5 & 6 | Connected Terminals | 1 & 2, 4 & 5 |
| 1 | ON | NONE | OFF |
| 2 | (ON) | NONE | OFF |
| 3 | ON | NONE | (OFF) |
| 4 | ON | NONE | ON |
| 5 | ON | NONE | (ON) |
| 6 | ON | NONE | ON |
| 7 | ON | OFF | ON |
| 8 | ON | OFF | (ON) |
| | (ON) | OFF | (ON) |

SPECIAL CIRCUITS

| | | | |
|----|----------------|--------------|-------|
| H* | 2 & 3 | 2 & 3, 5 & 4 | 5 & 4 |
| G* | 2 & 3, 5 & 6 | 2 & 3 | OFF |
| S* | 2 & 3, 5 & 6 | 2 & 3 | 1 & 2 |
| M* | (2 & 3, 5 & 6) | 2 & 3 | OFF |
| E* | (2 & 3, 5 & 6) | 2 & 3 | 1 & 2 |
| | 5 & 6 | 5 & 3 | 5 & 1 |

*Jumper between terminals 2 & 5 for circuits H, G, & M are specified in selection 4. External jumper between terminals 2 & 4 for circuit E are provided by customer. Circuit E may be used for SP OFF-ON-ON circuit.

3 RATING⁴

| | |
|----------|--|
| 1 | .4VA @ 28VDC Resistive |
| B | 15A 24V |
| C | 20A 18V |
| D | 20A 12V |
| E | 20A 14V, 10A 14VT (circuit 1, 4, A & D only) |
| F | 10A 14V, 6A 14VT (circuit G only) |
| M | .4VA/20A 12V |
| N | .4VA/15A 24V |

4 TERMINATION/BASE STYLE

| | | | |
|----------|----------|-----------------------------|-------------|
| 8 term | 10 term | Termination | Jumper |
| 1 | 2 | .250 TAB (QC) no barriers | No |
| A | B | .250 TAB (QC) with barriers | No |
| J | K | .250 TAB (QC) no barriers | Yes T2 to 5 |
| 3 | 4 | Solder Lug no barriers | No |
| C | D | Solder Lug | No |
| 5 | 6 | Wire Leads no barriers | No |
| E | F | Wire Leads | No |

Note: Codes J & K for circuits H, G & M.

5 ILLUMINATION & SWITCH SEALING

Lamp #1: above terminals 1 & 4 end of switch.; Lamp #2 above terminals 3 & 6 end of switch. Positive (+) and negative (-) symbols apply to LED lamps only

| | | | | |
|----------|----------|-------|---|-------------------------|
| Sealed | Unsealed | Lamps | Actuator Lens position when Illuminated | Lamp wired to Terminals |
| S | 0 | NONE | | |
| C | 3 | # 2 | Up | 3+ 7- |
| H | Z | # 2 | Independent | 8+ 7- |

Selections for Double Pole Switches Only:

| | | | | |
|----------|----------|-----|----|-------|
| M | R | # 2 | Up | 3+ 6- |
|----------|----------|-----|----|-------|

6 LOCK
Lock above terminals 1 & 4 end of switch.
W lock

Notes:
Consult factory to verify horsepower rating for your particular circuit choice.

- Custom colors are available. Consult factory.
- White imprinting is standard on black actuators; Black imprinting is standard on white, red and gray actuators; Custom colors are available, consult factory.
- Only available with 3 position circuits. Center OFF and special circuits only available with center position lock function.
- Additional ratings available. See page 20.

7 LAMP
Lamp above terminals 3 & 6 end of switch

| | | | | | |
|--------------|-----------------|-----------------|--------------------------|--------------------------|--------------------------|
| No lamp | 0 | | | | |
| Neon | 1 125VAC | 2 250VAC | | | |
| Incandescent | 4 3V | 5 6V | 6 12V superbright | 7 18V superbright | 8 24V superbright |
| LED* | A Red | L Amber | F Green | R Red | |
| 2VDC | B | M | G | S | |
| 6VDC | C | N | H | T | |
| 12VDC | D | P | J | V | |
| 24VDC | | | | | |

* Consult factory for "daylight bright" LED options. Typical current draw for LED is 20ma.

8 FLUSH BRACKET COLOR¹, PANEL SEAL

| | | | |
|----------|----------|----------|----------|
| No Seal | Black | White | Gray |
| One Seal | B | W | H |
| | C | Y | |

9 HARD SURFACE ACTUATOR¹

| | | | | |
|-------------|----------------|---------------|--------------|----------------|
| Contura II | Black A | Grey B | Red G | White H |
| Contura III | C | D | E | F |

Actuator orientation above terminals:
3.6 1.4

10 LENS
Z - No Lens

| | | | | | |
|----------|----------|----------|----------|----------|----------|
| Clear | White | Amber | Green | Red | Blue |
| 3 | 8 | D | J | P | V |

Lens color for LEDs must be clear, white, or match color of LED. Green or blue lenses are not recommended with Neon lamps.

11 ACTUATOR LOCK FUNCTION AND COLOR¹

| | | | | |
|----------------|----------|----------|-----------|---------------------|
| Lock Color | Up | Down | Up & Down | Center ³ |
| Match Actuator | A | H | R | 1 |
| Black | B | J | S | 2 |
| White | C | K | T | 3 |
| Red | D | L | V | 4 |
| Safety Orange | E | M | W | 5 |

12 ACTUATOR LENS OR BODY LEGEND²

00 - No Legend

| | | | |
|-----------|-----------|-----------|-----------|
| 21 | 22 | 23 | 24 |
| OFF | ON | O | I |
| 25 | 26 | 27 | 28 |
| O | O | O | I |
| F | N | | |

For additional legend options & codes, visit us at www.carlingtech.com.

13 LEGEND ORIENTATION

0 No legend (used with codes 21-28 in selection 12)

1 Orientation 1

2 Orientation 2

3 Orientation 3

4 Orientation 4

V 1 D A B T O B — E P C 00 — 0 00

1 Series 2 Circuit 3 Rating 4 Termination Illumination 5 Lamp 6 Lamp 7 Lamp 8 Bracket 9 Actuator 10 Lens 11 Color 12 Legend 13 Legend Orientation 14 Actuator Lens Legend

1 SERIES
V

2 CIRCUIT
Terminal Connections as viewed from bottom of switch: () - momentary

| | | |
|------------|-------------|--|
| 8 terminal | 10 terminal | SP - single pole - uses terminals 1, 2 & 3. |
| 8 - -7 | 8 - -7 | DP - double pole uses terminals 1, 2, 3, 4, 5 & 6. |
| 1 - -4 | 1 - -4 | Terminals 7, 8, 9 & 10 for lamp circuit only. |
| 2 - -5 | 2 - -5 | |
| 3 - -6 | 3 - -6 | |
| | 10 - -9 | |

Position:

| | | | | |
|----|----|--------------|---------------------|--------------|
| SP | DP | 1 | 2 | 3 |
| 1 | A | 2 & 3, 5 & 6 | Connected Terminals | 1 & 2, 4 & 5 |
| 2 | B | ON | NONE | OFF |
| 3 | C | ON | NONE | OFF |
| 4 | D | ON | NONE | (OFF) |
| 5 | F | ON | NONE | (ON) |
| 6 | J | ON | OFF | ON |
| 7 | K | ON | OFF | (ON) |
| 8 | L | (ON) | OFF | (ON) |

SPECIAL CIRCUITS

| | | | |
|----|----------------|--------------|-------|
| H* | 2 & 3 | 2 & 3, 5 & 4 | 5 & 4 |
| G* | 2 & 3, 5 & 6 | 2 & 3 | OFF |
| S | 2 & 3, 5 & 6 | 2 & 3 | 1 & 2 |
| M* | (2 & 3, 5 & 6) | 2 & 3 | OFF |
| R | (2 & 3, 5 & 6) | 2 & 3 | 1 & 2 |
| E* | 5 & 6 | 5 & 3 | 5 & 1 |

*Jumper between terminals 2 & 5 for circuits H, G, & M are specified in selection 4. External jumper between terminals 2 & 4 for circuit E are provided by customer. Circuit E may be used for SP OFF-ON-ON circuit.

3 RATING⁴

1 .4VA @ 28VDC Resistive
 B 15A 24V
 C 20A 18V
 D 20A 12V
 E 20A 14V, 10A 14VT (circuit 1, 4, A & D only)
 F 10A 14V, 6A 14VT (circuit G only)
 M .4VA/20A 12V
 N .4VA/15A 24V

4 TERMINATION/BASE STYLE

| 8 term | 10 term | Termination | Jumper |
|--------|---------|-----------------------------|-------------|
| 1 | 2 | .250 TAB (QC) no barriers | No |
| A | B | .250 TAB (QC) with barriers | No |
| J | K | .250 TAB (QC) no barriers | Yes T2 to 5 |
| 3 | 4 | Solder Lug no barriers | No |
| C | D | Solder Lug | No |
| 5 | 6 | Wire Leads no barriers | No |
| E | F | Wire Leads | No |

Note: Codes J & K for circuits H, G & M.

5 ILLUMINATION & SWITCH SEALING
Lamp #1: above terminals 1 & 4 end of switch.; Lamp #2 above terminals 3 & 6 end of switch. Positive (+) and negative (-) symbols apply to LED lamps only

| Sealed | Unsealed | Lamps | Actuator Lens position when Illuminated | Lamp wired to Terminals |
|--------|----------|-------|---|-------------------------|
| S | 0 | NONE | | |
| A | 1 | #1 | Independent | 8+ 7- |
| B | 2 | #1 | Down | 3+ 7- |
| C | 3 | #2 | Up | 3+ 7- |
| D | 4 | #1 | Down | 3+ 7- |
| E | 5 | #1 | Up | 1+ 7- |
| F | 6 | #1 | Up | 1+ 7- |
| G | 7 | #1 | Independent | 8+ 7- |
| H | Z | #2 | Up | 3+ 6- |
| U | Y | #1 | Independent | 8+ 7- |
| | | #2 | Independent | 8+ 7- |

Selections for Single Pole Switches Only:

| | | | | |
|---|---|----|-------------|-------|
| J | 8 | #1 | Down | 3+ 8- |
| | | #2 | Independent | 6+ 7- |
| K | W | #1 | Independent | 8+ 7- |
| | | #2 | Independent | 6+ 7- |

Selections for Double Pole Switches Only:

| | | | | |
|---|---|----|------|-------|
| L | 9 | #1 | Down | 3+ 6- |
| M | R | #2 | Up | 3+ 6- |
| N | T | #1 | Down | 3+ 6- |
| | | #2 | Down | 1+ 4- |
| P | V | #1 | Up | 1+ 4- |
| | | #2 | Up | 3+ 6- |

6,7 LAMP (same coding for both selections)
Selection 6: above terminals 1 & 4; Selection 7: above terminals 3 & 6

| | | | | | |
|-------------------|----------|----------|-------------------------|-----------------------|-----------------------|
| No lamp | 0 | 2 250VAC | 6 12V superbright Green | 7 18V superbright Red | 8 24V superbright Red |
| Neon | 1 125VAC | 5 6V | | | |
| Incandescent LED* | 4 3V | | | | |

2VDC A Red
 6VDC B Amber
 12VDC C Green
 24VDC D

L L Amber
 M M Green
 N N
 P P

F F superbright Green
 G G
 H H
 J J

R R
 S S
 T T
 V V

* Consult factory for "daylight bright" LED options. Typical current draw for LED is 20ma.

8 FLUSH BRACKET COLOR¹, PANEL SEAL

| | | | |
|----------|-------|-------|------|
| | Black | White | Gray |
| No Seal | B | W | G |
| One Seal | C | Y | H |

9 ACTUATOR

| | | |
|---|---|--|
| No Actuator | 0 | |
| Contura IV, left orientation | E | |
| Contura IV, left orientation, laser etched | T | |
| Contura IV, right orientation | F | |
| Contura IV, right orientation, laser etched | R | |

Actuator orientation above terminals:

10 LENS

| | | | | | | |
|-----------------|-------------|-------|-----|------|---|---|
| 0 - No Actuator | Z - No Lens | Green | Red | Blue | | |
| Clear | White | Amber | | | | |
| 1 | 6 | B | G | M | | T |
| 2 | 7 | C | H | N | | U |
| 3 | 8 | D | J | P | | V |
| 4 | 9 | E | K | R | | W |
| 5 | A | F | L | S | Y | |

Lens color for LEDs must be clear, white, or match color of LED. Green or blue lenses are not recommended with Neon lamps.

11 ACTUATOR COLOR^{1,5,6}

No Actuator 0 Black C Gray H Red S White Y Nickel D Pewter E

12 ACTUATOR LENS OR BODY LEGENDS²

| | | | | |
|-------|--------|-------|-------|--|
| 11 ON | 12 OFF | 13 I | 14 O | |
| OFF | ON | O | I | |
| 15 OO | 16 OO | 17 OI | 18 IO | |
| F N | F N | F | F | |

For additional legend options & codes, visit us at www.carlingtech.com.

13 LEGEND ORIENTATION

0 No legend (used with codes 11-18 in selection 12)

1 Orientation 1
 2 Orientation 2
 3 Orientation 3
 4 Orientation 4

14 ACTUATOR LENS LEGEND

00 No legend this location / no actuator (used with codes 11-18 in selection 12) Selection 14 required when switch requires two legends. If the two legends consist of one lens and one body legend, lens legend must be specified in selection 12; body legend specified in selection 14. For legend options & codes, visit us at www.carlingtech.com.

- Notes:
- Consult factory to verify horsepower rating for your particular circuit choice.
 - Custom colors are available. Consult factory.
 - White imprinting is standard on black actuators; Black imprinting is standard on white, red and gray actuators; Custom colors are available, consult factory.
 - Gloss brow is on left side of E actuator and right side of F actuator.
 - Additional ratings available. See page 20.
 - Laser etched rocker only available with lens code Z & actuator colors black, nickel or pewter.
 - Pewter and nickel colors only available with laser etched actuator.

| | | | | | | | | | | | | | |
|----------|-----------|----------|---------------|----------------|--------|--------|-----------|------------|---------|----------|-----------|-----------------------|-------------------------|
| V | 1 | D | A | B | T | O | B | G | P | C | 00 | 0 | 00 |
| 1 Series | 2 Circuit | 3 Rating | 4 Termination | 5 Illumination | 6 Lamp | 7 Lamp | 8 Bracket | 9 Actuator | 10 Lens | 11 Color | 12 Legend | 13 Legend Orientation | 14 Actuator Lens Legend |

1 SERIES
V

2 CIRCUIT
Terminal Connections as viewed from bottom of switch: () - momentary

| | | |
|------------|-------------|--|
| 8 terminal | 10 terminal | SP - single pole - uses terminals 1, 2 & 3. |
| 8 - -7 | 8 - -7 | DP - double pole uses terminals 1, 2, 3, 4, 5 & 6. |
| 1 - -4 | 1 - -4 | Terminals 7, 8, 9 & 10 for lamp circuit only. |
| 2 - -5 | 2 - -5 | |
| 3 - -6 | 3 - -6 | |
| | 10 - -9 | |

Position:

| | | | | |
|----|----|------|------|-------|
| SP | DP | 1 | 2 | 3 |
| 1 | A | ON | NONE | OFF |
| 2 | B | (ON) | NONE | OFF |
| 3 | C | ON | NONE | (OFF) |
| 4 | D | ON | NONE | ON |
| 5 | F | ON | NONE | (ON) |
| 6 | J | ON | OFF | ON |
| 7 | K | ON | OFF | (ON) |
| 8 | L | (ON) | OFF | (ON) |

SPECIAL CIRCUITS

| | | | |
|----|----------------|--------------|-------|
| H* | 2 & 3 | 2 & 3, 5 & 4 | 5 & 4 |
| G* | 2 & 3, 5 & 6 | 2 & 3 | OFF |
| S | 2 & 3, 5 & 6 | 2 & 3 | 1 & 2 |
| M* | (2 & 3, 5 & 6) | 2 & 3 | OFF |
| R | (2 & 3, 5 & 6) | 2 & 3 | 1 & 2 |
| E* | 5 & 6 | 5 & 3 | 5 & 1 |

*Jumper between terminals 2 & 5 for circuits H, G, & M are specified in selection 4. External jumper between terminals 2 & 4 for circuit E are provided by customer. Circuit E may be used for SP OFF-ON-ON circuit.

3 RATING⁴

1 .4VA @ 28VDC Resistive
 B 15A 24V
 C 20A 18V
 D 20A 12V
 E 20A 14V, 10A 14VT (circuit 1, 4, A & D only)
 F 10A 14V, 6A 14VT (circuit G only)
 M .4VA/20A 12V
 N .4VA/15A 24V

4 TERMINATION/BASE STYLE

| 8 term | 10 term | Termination | Jumper |
|--------|---------|-----------------------------|-------------|
| 1 | 2 | .250 TAB (QC) no barriers | No |
| A | B | .250 TAB (QC) with barriers | No |
| J | K | .250 TAB (QC) no barriers | Yes T2 to 5 |
| 3 | 4 | Solder Lug no barriers | No |
| C | D | Solder Lug | No |
| 5 | 6 | Wire Leads no barriers | No |
| E | F | Wire Leads | No |

Note: Codes J & K for circuits H, G & M.

5 ILLUMINATION & SWITCH SEALING
Lamp #1: above terminals 1 & 4 end of switch.; Lamp #2 above terminals 3 & 6 end of switch. Positive (+) and negative (-) symbols apply to LED lamps only

| Sealed | Unsealed | Lamps | Actuator Lens position when Illuminated | Lamp wired to Terminals |
|--------|----------|-------|---|-------------------------|
| S | 0 | NONE | | |
| A | 1 | #1 | Independent | 8+ 7- |
| B | 2 | #1 | Down | 3+ 7- |
| C | 3 | #2 | Up | 3+ 7- |
| D | 4 | #1 | Down | 3+ 7- |
| E | 5 | | Down | 1+ 7- |
| | | #1 | Up | 1+ 7- |
| | | | Up | 3+ 7- |
| F | 6 | #1 | Independent | 8+ 7- |
| | | | Up | 3+ 6- |
| G | 7 | #1 | Independent | 8+ 7- |
| | | | Up | 3+ 7- |
| H | Z | #2 | Independent | 8+ 7- |
| U | Y | #1 | Independent | 8+ 7- |
| | | | Independent | 10+ 9- |

Selections for Single Pole Switches Only:

| | | | | |
|---|---|-----|-------------|-------|
| J | 8 | #1 | Down | 3+ 8- |
| | | | Independent | 6+ 7- |
| K | W | #1 | Independent | 8+ 7- |
| | | | Independent | 6+ 7- |

Selections for Double Pole Switches Only:

| | | | | |
|---|---|-----|------|-------|
| L | 9 | #1 | Down | 3+ 6- |
| M | R | #2 | Up | 3+ 6- |
| N | T | #1 | Down | 3+ 6- |
| | | | Down | 1+ 4- |
| P | V | #1 | Up | 1+ 4- |
| | | | Up | 3+ 6- |

6,7 LAMP (same coding for both selections)
Selection 6: above terminals 1 & 4; Selection 7: above terminals 3 & 6

| | | | | | |
|-------------------|----------|----------|-------------------|-------------------|-------------------|
| No lamp | 0 | 2 250VAC | 6 12V superbright | 7 18V superbright | 8 24V superbright |
| Neon | 1 125VAC | 5 6V | Green | Red | Red |
| Incandescent LED* | 4 3V | | | | |
| 2VDC | Red | Amber | superbright | | |
| 6VDC | A | L | Green | | |
| 12VDC | B | M | | | |
| 24VDC | C | N | | | |
| | D | P | | | |

* Consult factory for "daylight bright" LED options. Typical current draw for LED is 20ma.

8 FLUSH BRACKET COLOR¹, PANEL SEAL

| | | | |
|----------|-------|-------|------|
| | Black | White | Gray |
| No Seal | B | W | G |
| One Seal | C | Y | H |

9 ACTUATOR

| | |
|-------------------------|---|
| No Actuator | 0 |
| Contura V | G |
| Contura V, laser etched | P |

10 LENS
Lens color for LEDs must be clear, white, or match color of LED. Lens style & location: #1/ #2
Green or blue lenses are not recommended with Neon lamps.

| | | | | | |
|-----------------|-------------|-------|-------|-----|-------------|
| 0 - No Actuator | Z - No Lens | | | | |
| Clear | White | Amber | Green | Red | Blue |
| 1 | 6 | B | G | M | T bar |
| 2 | 7 | C | H | N | U bar/bar |
| 3 | 8 | D | J | P | V oval |
| 4 | 9 | E | K | R | W oval/bar |
| 5 | A | F | L | S | Y oval/oval |

11 ACTUATOR COLOR^{1,3,3}

| | | | | | | | | | | | | | |
|-------------|---|-------|---|------|---|-----|---|-------|---|--------|---|--------|---|
| No Actuator | 0 | Black | C | Gray | H | Red | S | White | Y | Nickel | D | Pewter | E |
|-------------|---|-------|---|------|---|-----|---|-------|---|--------|---|--------|---|

12 ACTUATOR LENS OR BODY LEGENDS^{2,6}

| | | | |
|--------|--------|--------|--------|
| 11 ON | 12 OFF | 13 I | 14 O |
| OFF | ON | O | I |
| 15 O O | 16 O O | 17 O I | 18 I O |
| F N | F N | | |
| F | F | | |

For additional legend options & codes, visit us at www.carlingtech.com.

13 LEGEND ORIENTATION

0 No legend (used with codes 11-18 in selection 12)
 1 Orientation 1
 2 Orientation 2
 3 Orientation 3
 4 Orientation 4

14 ACTUATOR LENS LEGEND

00 No legend this location / no actuator
 (used with codes 11-18 in selection 12) Selection 14 required when switch requires two legends. If the two legends consist of one lens and one body legend, lens legend must be specified in selection 12; body legend specified in selection 14.
 For legend options & codes, visit us at www.carlingtech.com.

- Notes:
- Consult factory to verify horsepower rating for your particular circuit choice.
 - Custom colors are available. Consult factory.
 - White imprinting is standard on black actuators; Black imprinting is standard on white, red and gray actuators; Custom colors are available, consult factory.
 - Laser Etched rocker only available with lens code Z & actuator colors black, nickel or pewter.
 - Additional ratings available. See page 20.
 - Nickel and Pewter colors only available with laser etched actuator. Consult factory for laser etched lens callout.

V 1 D A S W O B — J Z E 00 — 0

1 Series 2 Circuit 3 Rating 4 Termination Illumination Lock 5 Lamp 6 Bracket 7 Actuator 8 Lens 9 Function 10 Legend 11 Legend 12 Legend 13 Legend Orientation

1 SERIES
V

2 CIRCUIT³
Terminal Connections as viewed from bottom of switch:

| 8 terminal | 10 terminal | () - momentary |
|------------|-------------|--|
| 8 - -7 | 8 - -7 | SP - single pole - uses terminals 1, 2 & 3. |
| 1 - -4 | 1 - -4 | DP - double pole uses terminals 1, 2, 3, 4, 5 & 6. |
| 2 - -5 | 2 - -5 | Terminals 7 & 8 for lamp circuit only. |
| 3 - -6 | 3 - -6 | Terminals 9 & 10 are not used with locking style switches. |
| 10 - -9 | 10 - -9 | |

Position:

| SP | DP | 2 & 3, 5 & 6 | 1 | 2 | 3 |
|----|----|--------------|--------------|------|------|
| 1 | A | ON | Connected | NONE | OFF |
| 4 | D | ON | Terminals | NONE | ON |
| 6 | J | ON | 1 & 2, 4 & 5 | OFF | ON |
| 7 | K | ON | | OFF | (ON) |
| 8 | L | (ON) | | OFF | (ON) |
| 9 | N | OFF | | NONE | ON |

3 RATING⁴

1 .4VA @ 28VDC Resistive
B 15A 24V
C 20A 18V
D 20A 12V
E 20A 14V, 10A 14VT (circuit 1, 4, A & D only)
F 10A 14V, 6A 14VT (circuit G only)
M .4VA/20A 12V
N .4VA/15A 24V

4 TERMINATION/BASE STYLE

| 8 term | 10 term | Termination | Jumper |
|--------|---------|-----------------------------|-------------|
| 1 | 2 | .250 TAB (QC) no barriers | No |
| A | B | .250 TAB (QC) with barriers | No |
| J | K | .250 TAB (QC) no barriers | Yes T2 to 5 |
| 3 | 4 | Solder Lug no barriers | No |
| C | D | Solder Lug | No |
| 5 | 6 | Wire Leads no barriers | No |
| E | F | Wire Leads | No |

Note: Codes J & K for circuits H, G & M.

5 ILLUMINATION & SWITCH SEALING

Lamp #1: above terminals 1 & 4 end of switch.; Lamp #2 above terminals 3 & 6 end of switch. Positive (+) and negative (-) symbols apply to LED lamps only

| Sealed | Unsealed | Lamps | Actuator Lens position when Illuminated | Lamp wired to Terminals |
|--------|----------|-------|---|-------------------------|
| S | 0 | NONE | | |
| C | 3 | # 2 | Up | 3+ 7- |
| H | Z | # 2 | Independent | 8+ 7- |
| M | R | # 2 | Up | 3+ 6- |

Selections for Double Pole Switches Only:

6 LOCK

Lock above terminals 1 & 4 end of switch.

| | | | |
|---|------------------|----------------|-------------------|
| W | low profile lock | Y ⁶ | high profile lock |
|---|------------------|----------------|-------------------|

7 LAMP
Lamp above terminals 3 & 6 end of switch

| | | | | | | |
|-------------------|---|----------|----------|-------------------------|-----------------------|-----------------------|
| No lamp | 0 | 1 125VAC | 2 250VAC | 6 12V superbright Green | 7 18V superbright Red | 8 24V superbright Red |
| Neon | 1 | 4 3V | 5 6V | | | |
| Incandescent LED* | | Red | Amber | | | |
| 2VDC | A | L | F | | | |
| 6VDC | B | M | G | | | |
| 12VDC | C | N | H | | | |
| 24VDC | D | P | J | | | |

8 FLUSH BRACKET COLOR¹, PANEL SEAL

| | | | |
|----------|-------|-------|------|
| No Seal | Black | White | Gray |
| One Seal | B | W | H |
| | C | Y | |

9 HARD SURFACE ACTUATOR
CONTURA IV:

| | | | | |
|-------------|-------|------|-----|-------|
| Orientation | Black | Grey | Red | White |
| Left | J | K | L | M |
| Right | N | P | R | S |

Actuator orientation above terminals: 3,6 1,4

CONTURA V:

| | | | | |
|-------------|-------|------|-----|-------|
| Orientation | Black | Grey | Red | White |
| | U | V | W | Y |

Actuator orientation above terminals: 3,6 1,4

10 LENS⁵
Z - No Lens

| | | | | | |
|-------|-------|-------|-------|-----|------|
| Clear | White | Amber | Green | Red | Blue |
| A | B | C | D | E | F |
| G | H | J | K | L | M |

Lens color for LEDs must be clear, white, or match color of LED. Green or blue lenses are not recommended with Neon lamps.

bar lens
oval lens

11 ACTUATOR LOCK FUNCTION AND COLOR¹

| | | | | |
|----------------|----|------|-----------|---------------------|
| Lock Color | Up | Down | Up & Down | Center ³ |
| Match Actuator | A | H | R | 1 |
| Black | B | J | S | 2 |
| White | C | K | T | 3 |
| Red | D | L | V | 4 |
| Safety Orange | E | M | W | 5 |
| Gray | F | G | N | 6 |

12 ACTUATOR LENS OR BODY LEGEND²
00 - No Legend

| | | | |
|-----|----|----|----|
| 21 | 22 | 23 | 24 |
| OFF | ON | O | I |
| 25 | 26 | 27 | 28 |
| O | O | O | I |
| F | N | | |

For additional legend options & codes, visit us at www.carlingtech.com.

13 LEGEND ORIENTATION

| | |
|---|---------------|
| 0 | No legend |
| 1 | Orientation 1 |
| 2 | Orientation 2 |
| 3 | Orientation 3 |
| 4 | Orientation 4 |

Notes:
 Consult factory to verify horsepower rating for your particular circuit choice.
 1 Custom colors are available. Consult factory.
 2 White imprinting is standard on black actuators; Black imprinting is standard on white, red and gray actuators; Custom colors are available, consult factory.
 3 Only available with 3 position circuits. Center OFF and special circuits only available with center position lock function.
 4 Additional ratings available. See page 20.
 5 Located at T3-6 end of switch.
 6 Contura V style only.

V 1 D B G N T B - H A 7 C B AC - 1 00

1 Series 2 Circuit 3 Rating 4 Termination Illumination Lamp 5 Lamp 6 Lamp 7 Lamp 8 Bracket 9 Actuator 10 Lens 11 Lens 12 Color 13 Insert Color 14 Actuator Lens 15 Legend Orientation Lens Legend 16 Actuator Lens Legend

1 SERIES

V

2 CIRCUIT

Terminal Connections as viewed from bottom of switch: () - momentary
 8 terminal 10 terminal
 8 - - 7 8 - - 7
 1 - - 4 1 - - 4
 2 - - 5 2 - - 5
 3 - - 6 3 - - 6
 10 - - 9

SP - single pole - uses terminals 1, 2 & 3.
 DP - double pole uses terminals 1, 2, 3, 4, 5 & 6.
 Terminals 7, 8, 9 & 10 for lamp circuit only.

Position:

| Position: | DP | 1 | 2 | 3 |
|-----------|----|--------------|---------------------|--------------|
| SP | | 2 & 3, 5 & 6 | Connected Terminals | 1 & 2, 4 & 5 |
| 1 | A | ON | NONE | OFF |
| 2 | B | (ON) | NONE | OFF |
| 3 | C | ON | NONE | (OFF) |
| 4 | D | ON | NONE | ON |
| 5 | F | ON | NONE | (ON) |
| 6 | J | ON | OFF | ON |
| 7 | K | ON | OFF | (ON) |
| 8 | L | (ON) | OFF | (ON) |

SPECIAL CIRCUITS

| | 2 & 3 | 2 & 3, 5 & 4 | 5 & 4 |
|----|----------------|--------------|-------|
| H* | 2 & 3 | 2 & 3, 5 & 4 | 5 & 4 |
| G* | 2 & 3, 5 & 6 | 2 & 3 | OFF |
| S* | 2 & 3, 5 & 6 | 2 & 3 | 1 & 2 |
| M* | (2 & 3, 5 & 6) | 2 & 3 | OFF |
| R* | (2 & 3, 5 & 6) | 2 & 3 | 1 & 2 |
| E* | 5 & 6 | 5 & 3 | 5 & 1 |

*Jumper between terminals 2 & 5 for circuits H, G, & M are specified in selection 4.
 External jumper between terminals 2 & 4 for circuit E are provided by customer. Circuit E may be used for SP OFF-ON-ON circuit.

3 RATING³

- 1 .4VA @ 28VDC Resistive
- B 15A 24V
- C 20A 18V
- D 20A 12V
- E 20A 14V, 10A 14VT (circuit 1, 4, A & D only)
- F 10A 14V, 6A 14VT (circuit G only)
- M .4VA/20A 12V
- N .4VA/15A 24V

4 TERMINATION/BASE STYLE

| 8 term | 10 term | Termination | Jumper |
|--------|---------|-----------------------------|-------------|
| 1 | 2 | .250 TAB (QC) no barriers | No |
| A | B | .250 TAB (QC) with barriers | No |
| J | K | .250 TAB (QC) no barriers | Yes T2 to 5 |
| 3 | 4 | Solder Lug no barriers | No |
| C | D | Solder Lug | No |
| 5 | 6 | Wire Leads no barriers | No |
| E | F | Wire Leads | No |

5 ILLUMINATION & SWITCH SEALING

Lamp #1: above terminals 1 & 4 end of switch.; Lamp #2 above terminals 3 & 6 end of switch. Positive (+) and negative (-) symbols apply to LED lamps only

| Sealed | Unsealed | Lamps | Actuator Lens position when Illuminated | Lamp wired to Terminals |
|---|----------|-------|---|-------------------------|
| S | 0 | NONE | | |
| A | 1 | # 1 | Independent | 8+ 7- |
| B | 2 | # 1 | Down | 3+ 7- |
| C | 3 | # 2 | Up | 3+ 7- |
| D | 4 | # 1 | Down | 3+ 7- |
| E | 5 | &# 2 | Down | 1+ 7- |
| F | 6 | # 1 | Up | 1+ 7- |
| G | 7 | &# 2 | Up | 3+ 7- |
| H | Z | # 1 | Independent | 8+ 7- |
| U | Y | # 2 | Independent | 3+ 6- |
| | | &# 2 | Independent | 8+ 7- |
| | | &# 2 | Independent | 10+ 9- |
| Selections for Single Pole Switches Only: | | | | |
| J | 8 | # 1 | Down | 3+ 8- |
| | | &# 2 | Independent | 6+ 7- |
| K | W | # 1 | Independent | 8+ 7- |
| | | &# 2 | Independent | 6+ 7- |
| Selections for Double Pole Switches Only: | | | | |
| L | 9 | # 1 | Down | 3+ 6- |
| M | R | # 2 | Up | 3+ 6- |
| N | T | # 1 | Down | 3+ 6- |
| | | &# 2 | Down | 1+ 4- |
| P | V | # 1 | Up | 1+ 4- |
| | | &# 2 | Up | 3+ 6- |

6,7 LAMP (same coding for both selections)

Selection 6: above terminals 1 & 4; Selection 7: above terminals 3 & 6

| | | | | | |
|--------------|-----|--------|-------|-----------------|-----------------|
| No lamp | 0 | | | | |
| Neon | 1 | 125VAC | 2 | 250VAC | |
| Incandescent | 4 | 3V | 5 | 6V | |
| LED* | | | 6 | 12V superbright | 7 |
| | | | | Green | 18V superbright |
| | | | | Red | |
| 2VDC | Red | | Amber | | |
| 6VDC | A | | L | | |
| 12VDC | B | | M | | |
| 24VDC | C | | N | | |
| | D | | P | | |
| | | | H | | |
| | | | J | | |
| | | | K | | |
| | | | L | | |
| | | | M | | |
| | | | N | | |
| | | | O | | |
| | | | P | | |
| | | | Q | | |
| | | | R | | |
| | | | S | | |
| | | | T | | |
| | | | U | | |
| | | | V | | |
| | | | W | | |
| | | | X | | |
| | | | Y | | |
| | | | Z | | |

* Consult factory for "daylight bright" LED options. Typical current draw for LED is 20ma.

8 FLUSH BRACKET COLOR¹; PANEL SEAL

| | Black | White | Gray |
|----------|-------|-------|------|
| No Seal | B | W | G |
| One Seal | C | Y | H |

9 ACTUATOR

| | | | | | |
|---|-------------|---|-------------|---|------------|
| 0 | No Actuator | H | High Insert | L | Low Insert |
|---|-------------|---|-------------|---|------------|

10,11 LENS⁴

Lens color for LEDs must be clear, white, or match color of LED. Green or blue lenses are not recommended with Neon lamps.

| 0 - No Actuator | Z - No Lens | | | | | |
|-----------------|-------------|-------|-------|-----|------|-----------------------|
| Clear | White | Amber | Green | Red | Blue | |
| - | 7 | C | H | N | U | Bar Lens Translucent |
| 3 | - | D | J | P | V | Bar Lens Transparent |
| 4 | - | E | K | R | W | Oval Lens Transparent |
| - | A | F | L | S | Y | Oval Lens Translucent |

12 ACTUATOR COLOR

| | | | | | | | |
|---|-------|---|------|---|-----|---|-------|
| C | Black | H | Gray | S | Red | Y | White |
|---|-------|---|------|---|-----|---|-------|

13 INSERT COLOR

| | | | |
|---|----------------------|---|----------------------|
| B | Black | N | Bright Nickel Plated |
| C | Bright Chrome Plated | S | Satin Chrome Plated |
| D | Satin Chrome Painted | T | Satin Nickel Plated |
| | | W | White |

14 ACTUATOR LENS OR BODY LEGENDS²

| | | |
|----|-------------------------------------|-----------|
| 00 | No Legend this location/No actuator | |
| 11 | ON OFF | 12 OFF ON |
| 13 | I O | 14 O I |
| 15 | O O | 16 O O |
| | F N | 17 O I |
| | F F | 18 I O |

For additional legend options & codes, see pages 54-65 of the Carling Transportation catalog

15 LEGEND ORIENTATION

| | | |
|---|---|--|
| 0 | No legend (used with codes 11-18 in selection 12) | |
| 1 | Orientation 1 | |
| 2 | Orientation 2 | |
| 3 | Orientation 3 | |
| 4 | Orientation 4 | |

16 ACTUATOR LENS LEGEND

00 No legend this location / no actuator (used with codes 11-18 in selection 12) Selection 14 required when switch requires two legends. If the two legends consist of one lens and one body legend, lens legend must be specified in selection 12; body legend specified in selection 14. For legend options & codes, visit us at www.carlingtech.com.

- Notes:
- Consult factory to verify horsepower rating for your particular circuit choice.
 - Custom colors are available. Consult factory.
 - White imprinting is standard on black actuators; Black imprinting is standard on white, red and gray actuators; Custom colors are available, consult factory.
 - Additional ratings available. See page 20.

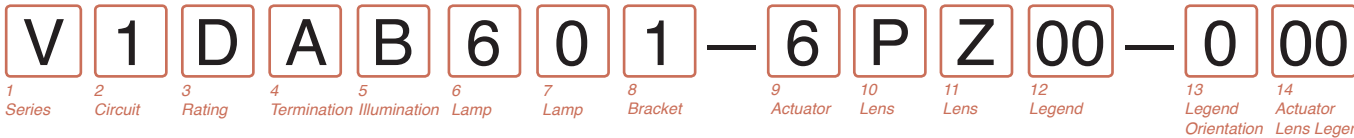

1 SERIES
V

2 CIRCUIT
Terminal Connections as viewed () - momentary
8 terminal 10 terminal
8- -7 8- -7
1- -4 1- -4
2- -5 2- -5
3- -6 3- -6
10- -9

SP - single pole - uses terminals 1, 2 & 3.
DP - double pole uses terminals 1, 2, 3, 4, 5 & 6.
Terminals 7, 8, 9 & 10 for lamp circuit only.

Position:

| SP | DP | 2 & 3, 5 & 6 | 1 | 2 | 3 |
|----|----|--------------|------|------|-------|
| A | B | ON | ON | NONE | OFF |
| 2 | A | (ON) | (ON) | NONE | OFF |
| 3 | B | ON | ON | NONE | (OFF) |
| 4 | C | ON | ON | NONE | ON |
| 5 | D | ON | ON | NONE | (ON) |
| 6 | E | ON | ON | OFF | ON |
| 7 | F | ON | ON | OFF | (ON) |
| 8 | J | ON | ON | OFF | ON |
| 9 | K | ON | ON | OFF | (ON) |
| 10 | L | (ON) | (ON) | OFF | (ON) |

SPECIAL CIRCUITS

| H* | G* | S | M* | R* | E* |
|-------|--------------|--------------|--------------|----------------|----------------|
| 2 & 3 | 2 & 3, 5 & 6 | 2 & 3, 5 & 6 | 2 & 3, 5 & 6 | (2 & 3, 5 & 6) | (2 & 3, 5 & 6) |
| 2 & 3 | 2 & 3 | 2 & 3 | 2 & 3 | 2 & 3 | 2 & 3 |
| 5 & 4 | 5 & 4 | 1 & 2 | OFF | 1 & 2 | 5 & 1 |

* Jumper between terminals 2 & 5 for circuits H, G, & M are specified in Selection 4.
External jumper between terminals 2 & 4 for circuit E are provided by customer. Circuit E may be used for SP OFF-ON-ON circuit.

3 RATING⁴

1 .4VA @ 28VDC Resistive
B 15A 24V
C 20A 18V
D 20A 12V
E 20A 14V, 10A 14VT (circuit 1, 4, A & D only)
F 10A 14V, 6A 14VT (circuit G only)
M .4VA/20A 12V
N .4VA/15A 24V

4 TERMINATION/BASE STYLE

| 8 term | 10 term | Termination | Jumper |
|--------|---------|----------------------------|-------------|
| 1 | 2 | 250 TAB (QC) no barriers | No |
| A | B | 250 TAB (QC) with barriers | No |
| J | K | 250 TAB (QC) no barriers | Yes T2 to 5 |
| 3 | 4 | Solder Lug no barriers | No |
| C | D | Solder Lug | No |
| 5 | 6 | Wire Leads no barriers | No |
| E | F | Wire Leads | No |

Note: Codes J & K for circuits H, G & M.

5 ILLUMINATION & SWITCH SEALING
Lamp #1: above terminals 1 & 4 end of switch.; Lamp #2 above terminals 3 & 6 end of switch. Positive (+) and negative (-) symbols apply to LED lamps only

| Sealed | Unsealed | Lamps | Actuator Lens position when Illuminated | Terminals |
|--------|----------|-------|---|-----------|
| S | 0 | NONE | | |
| A | 1 | #1 | Independent | 8+ 7- |
| B | 2 | #1 | Down | 3+ 7- |
| C | 3 | #2 | Up | 3+ 7- |
| D | 4 | #1 | Down | 3+ 7- |
| E | 5 | | Down | 1+ 7- |
| F | 6 | #1 | Up | 1+ 7- |
| G | 7 | | Up | 3+ 7- |
| H | Z | #1 | Independent | 8+ 7- |
| U | Y | #1 | Independent | 8+ 7- |
| | | | Independent | 10+ 9- |
| J | 8 | #1 | Down | 3+ 8- |
| K | W | | Independent | 6+ 7- |
| | | #1 | Independent | 8+ 7- |
| | | | Independent | 6+ 7- |
| L | 9 | #1 | Down | 3+ 6- |
| M | R | #2 | Up | 3+ 6- |
| N | T | #1 | Down | 3+ 6- |
| P | V | | Down | 1+ 4- |
| | | #1 | Up | 1+ 4- |
| | | | Up | 3+ 6- |

6,7 LAMP (same coding for both selections)
Selection 6: above terminals 1 & 4; Selection 7: above terminals 3 & 6

No lamp 0
Neon⁵ 1 125VAC 2 250VAC
Incandescent 4 3V 5 6V 6 12V superbright 7 18V superbright 8 24V Red
LED* Red Amber Green Red

2VDC A L F
6VDC B M G
12VDC C N H
24VDC D P J

* Consult factory for "daylight bright" LED options. Typical current draw for LED is 20ma.

8 BRACKET COLOR¹, PANEL SEAL (EXTERNAL FOAM GASKET)

| # of gaskets | X & XI w/Flush Bracket | 2 | X, XI, XII w/Raised Bracket | 0 | 1 |
|--------------|------------------------|---|-----------------------------|---|---|
| Black | B | C | D | 1 | 4 |
| White | W | Y | Z | 2 | 5 |
| Gray | G | H | J | 3 | 6 |

9 ACTUATOR

| No Actuator | 0 | Black | Gray | White | Red |
|-------------|---|-------|------|-------|-----|
| Contura X | 1 | 2 | 3 | 4 | |
| Contura XI | 6 | 7 | 8 | 9 | |
| Contura XII | J | K | N | M | |

Actuator orientation above terminals:
3,6 1,4

10 LENS - ABOVE LAMP #1 TERMINALS^{1,4}
11 LENS - ABOVE LAMP #2 TERMINALS^{3,6}

| 0 - No Actuator | Z - No Lens | Clear | White | Amber | Green | Red | Blue | Lens Style |
|-----------------|-------------|-------|-------|-------|-------|-----|------|--------------------------------|
| 3 | 8 | D | J | P | V | | | Bar |
| 4 | 9 | E | K | R | W | | | One piece Square |
| 5 | A | F | L | S | Y | | | Two piece Square* |
| | | | | | | | | (w/ clear top protective lens) |
| 2 | 7 | C | H | N | U | | | Two piece Square* |
| | | | | | | | | (w/ smoke top protective lens) |
| 1 | 6 | B | G | M | T | | | Two piece Square* |
| | | | | | | | | (w/ white top protective lens) |

* All bottom lenses are molded of opaque material. Consult factory for other lens colors. Lens color for LEDs must be clear, white, or match color of LED. Green or blue lenses are not recommended with Neon lamps.

12 ACTUATOR LENS OR BODY LEGEND²

00 - No Legend this location/No actuator

11 ON 12 OFF 13 I 14 O
OFF ON O I

15 O O 16 O O 17 O I 18 I O
F N N F
F F

21 OFF 22 ON 23 O 24 I

25 O 26 O 27 O 28 I
F N
F

For additional legend options & codes, visit us at www.carlingtech.com.

13 LEGEND ORIENTATION³

0 No legend (used with codes 11-18 in selection 12)

1 Orientation 1
2 Orientation 2
3 Orientation 3
4 Orientation 4

14 ACTUATOR LENS LEGEND

00 No legend this location / no actuator (used with codes 11-18 in selection 12) Selection 14 required when switch requires two legends. If the two legends consist of one lens and one body legend, lens legend must be specified in selection 12; body legend specified in selection 14. For legend options & codes, visit us at www.carlingtech.com.

Notes: Consult factory to verify horsepower rating for your particular circuit choice.
1 Custom colors are available. Consult factory.
2 White imprinting is standard on black actuators; Black imprinting is standard on white, red & gray actuators; Custom colors are available, consult factory.
3 With 2 square lenses, use sel. 12 for lens above lamp 1, & selection 14 for lens above lamp 2.
4 Additional ratings available. See page 20.
5 Not available with Contura XI rockers.

V 1 D A S W O 1 — 1 P B 00 — 0

1 Series 2 Circuit 3 Rating 4 Termination Illumination Lock 5 Lamp 6 Bracket 7 Actuator 8 Lens 9 Function 10 Legend 11 Legend 12 Legend 13 Orientation

1 SERIES
V

2 CIRCUIT
Terminal Connections as viewed from bottom of switch:
8 terminal 10 terminal
8 - -7 8 - -7
1 - -4 1 - -4
2 - -5 2 - -5
3 - -6 3 - -6
10 - -9

() - momentary
SP - single pole - uses terminals 1, 2 & 3.
DP - double pole uses terminals 1, 2, 3, 4, 5 & 6.
Terminals 7, 8, 9 & 10 for lamp circuit only.

Position:

| | | | |
|----|-----|------|-----|
| DP | 1 | 2 | 3 |
| A | ON | NONE | OFF |
| D | ON | NONE | ON |
| J | ON | OFF | ON |
| N | OFF | NONE | ON |

SPECIAL CIRCUITS

| | | | |
|----|--------------|--------------|-------|
| H* | 2 & 3 | 2 & 3, 5 & 4 | 5 & 4 |
| G* | 2 & 3, 5 & 6 | 2 & 3 | OFF |
| S | 2 & 3, 5 & 6 | 2 & 3 | 1 & 2 |
| E* | 5 & 6 | 5 & 3 | 5 & 1 |

*Jumper between terminals 2 & 5 for circuits H, G, & M are specified in selection 4. External jumper between terminals 2 & 4 for circuit E are provided by customer. Circuit E may be used for SP OFF-ON-ON circuit.

3 RATING⁴

1 .4VA @ 28VDC Resistive
B 15A 24V
C 20A 18V
D 20A 12V
E 20A 14V, 10A 14VT (circuit 1, 4, A & D only)
F 10A 14V, 6A 14VT (circuit G only)
M .4VA/20A 12V
N .4VA/15A 24V

4 TERMINATION/BASE STYLE

| 8 term | 10 term | Termination | Jumper |
|--------|---------|-----------------------------|-------------|
| 1 | 2 | .250 TAB (QC) no barriers | No |
| A | B | .250 TAB (QC) with barriers | No |
| J | K | .250 TAB (QC) no barriers | Yes T2 to 5 |
| 3 | 4 | Solder Lug no barriers | No |
| C | D | Solder Lug | No |
| 5 | 6 | Wire Leads no barriers | No |
| E | F | Wire Leads | No |

Note: Codes J & K for circuits H, G & M.

5 ILLUMINATION & SWITCH SEALING
Lamp above terminals 3 & 6 end of switch.
Positive (+) and negative (-) symbols apply to LED lamps only

| Sealed | Unsealed | Lamps | Actuator Lens position when Illuminated | Lamp wired to Terminals |
|--------|----------|-------|---|-------------------------|
| S | 0 | NONE | | |
| C | 3 | # 2 | Up | 3+ 7- |
| H | Z | # 2 | Independent | 8+ 7- |
| M | R | # 2 | Up | 3+ 6- |

Selections for Double Pole Switches Only:

6 LOCK
Lock above terminals 1 & 4 end of switch.
W lock

7 LAMP
Lamp above terminals 3 & 6 end of switch

| | | | | | |
|--------------|---|--------|---|--------|-------------------------|
| No lamp | 0 | | | | |
| Neon | 1 | 125VAC | 2 | 250VAC | |
| Incandescent | 4 | 3V | 5 | 6V | |
| LED* | | Red | | Amber | 6 12V superbright Green |
| | | A | | L | 7 18V superbright Red |
| 2VDC | | B | | M | 8 24V superbright Red |
| 6VDC | | C | | N | |
| 12VDC | | D | | P | |
| 24VDC | | | | | |

* Consult factory for "daylight bright" LED options. Typical current draw for LED is 20ma.

8 RAISED BRACKET COLOR¹, PANEL SEAL (EXTERNAL FOAM GASKET)

| | | | | | | |
|------------|---|-------|---|-------|---|------|
| No Gasket | 1 | Black | 2 | White | 3 | Gray |
| One Gasket | 4 | | 5 | | 6 | |

9 HARD SURFACE ACTUATOR

| | | | | | | | | |
|-----------|---|-------|---|------|---|-----|---|-------|
| Contura X | 1 | Black | 2 | Grey | 3 | Red | 4 | White |
|-----------|---|-------|---|------|---|-----|---|-------|

Actuator orientation above terminals: 3,6 1,4

10 LENS - ABOVE LAMP #2 TERMINALS^{3,6}
Z - No Lens

| Clear | White | Amber | Green | Red | Blue | Lens Style |
|-------|-------|-------|-------|-----|------|--------------------------------|
| 3 | 8 | D | J | P | V | Bar |
| 4 | 9 | E | K | R | W | One piece Square |
| 5 | A | F | L | S | Y | Two piece Square* |
| | | | | | | (w/ clear top protective lens) |
| 2 | 7 | C | H | N | U | Two piece Square* |
| | | | | | | (w/ smoke top protective lens) |
| 1 | 6 | B | G | M | T | Two piece Square* |
| | | | | | | (w/ white top protective lens) |

* All bottom lenses are molded of opaque material. Consult factory for other lens colors. Lens color for LEDs must be clear, white, or match color of LED. Green or blue lenses are not recommended with Neon lamps.

11 ACTUATOR LOCK FUNCTION AND COLOR³

| | | | |
|----------------|----|------|-----------|
| Lock Color | Up | Down | Up & Down |
| Match Actuator | A | H | R |
| Black | B | J | S |
| White | C | K | T |
| Red | D | L | V |
| Gray | E | M | W |
| Safety Orange | F | N | Y |

12 ACTUATOR LENS OR BODY LEGEND²
00 - No Legend

| | | | |
|-----|----|----|----|
| 21 | 22 | 23 | 24 |
| OFF | ON | O | I |
| 25 | O | 26 | O |
| F | N | 27 | O |
| F | | 28 | I |

For additional legend options & codes, visit us at www.carlingtech.com.

13 LEGEND ORIENTATION³

| | |
|---|---|
| 0 | No legend (used with codes 11-18 in selection 12) |
| 1 | Orientation 1 |
| 2 | Orientation 2 |
| 3 | Orientation 3 |
| 4 | Orientation 4 |

1PM4F-1
4F
45
18K45-2
MC

Notes:
Consult factory to verify horsepower rating for your particular circuit choice.
1 Custom colors are available. Consult factory.
2 White imprinting is standard on black actuators; Black imprinting is standard on white, red and gray actuators; Custom colors are available, consult factory.
3 Located over T1-4 end of switch.
4 Additional ratings available. See page 20.

Reduce inventory levels and cost by stocking actuators and base switches separately.

Contura II, III, IV, V, X, XI, XII Base switches separately: specify **V** with code selections 2-8 in the ordering schemes.

Contura II, III, IV, V Actuator only: VV with code **A** or **C** for selection 9, & with selections 10-14 in the ordering schemes.

Panel Seal: VPS

Contura II, III, IV, V Actuator only: VV with code **A, C, E, G** or **P** for selection 9 & with selections 10-14 in the ordering schemes.

Contura X, XI, XII actuators with lenses separately: VV with code selections 9-14 in the ordering schemes.

Contura X & XI actuators without lenses separately:

VVR 6 1 00 1

1 Actuator Separately 2 Actuator Style/Color 3 Lens Opening 4 Actuator Legend 5 Legend Orientation

1 CONTURA X & XI ACTUATOR SEPARATELY
VVP

2 ACTUATOR STYLE & COLOR

| | | | | |
|------------|-------|------|-------|-----|
| | Black | Gray | White | Red |
| Contura X | 1 | 2 | 3 | 4 |
| Contura XI | 6 | 7 | 8 | 9 |

3 LENS OPENING FOR¹

- 1 One bar lens
- 2 One bar lenses
- 3 One square lens
- 4 two square lens
- 5 square lens on top/
bar lens on bottom
(Contura X only)

4 ACTUATOR LENS OR BODY LEGEND

- 00 - No Legend this location
- 11 ON 12 OFF 13 I 14 O
- OFF ON O I
- 15 O O 16 O O 17 O I 18 I O
- F N N F
- F F

For additional legend options & codes, visit us at www.carlingtech.com.

5 LEGEND ORIENTATION¹

- 0 No legend
- 1 Orientation 1
- 2 Orientation 2
- 3 Orientation 3
- 4 Orientation 4

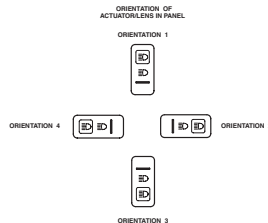

Contura X, XI & XII top piece of 2-piece lens separately:

VVT 1

1 Lens Separately 2 Color

1 TOP OF LENS SEPARATELY
VVT

- 2 COLOR**
1 Clear 2 Smoke 3 White

Contura X, XI & XII actuator lens assembly:



1 piece lens/bar lens are positioned the same as bottom lens for assembly, minus the top lens. Lenses snap in from bottom.

Notes:

- 1 If actuator lens opening for 2 bar or 2 square lenses, legend orientation 0,1, or 2 must be chosen.
- 2 Center of actuator marking not available for Contura XII.
- 3 Legend is not available for bar style lens.
- 4 Not recommended with neon lamps.
- 5 Must also order top piece of 2 piece square lens separately.

Contura XII actuators without lenses separately:

VVP J 1 Z 21 1 00

1 Actuator 2 Style & Color 3 Lens Opening 4 Lens Opening 5 Legend 6 Legend Orientation 7 Legend Orientation

1 CONTURA XII ACTUATOR SEPARATELY
VVP

2 ACTUATOR STYLE & COLOR

| | | | | | | | |
|---|-------|---|------|---|-------|---|-----|
| J | Black | K | Gray | N | White | M | Red |
|---|-------|---|------|---|-------|---|-----|

3,4 LENS OPENING FOR

- Z No lens 1 Bar lens 2 Square lens

5, 7 LENS OR BODY LEGEND²

- 00 - No Legend
- 21 OFF 22 ON 23 O 24 I
- 25 O 26 O 27 O 28 I
- F N
- F

For additional legend options & codes, visit us at www.carlingtech.com.

6 LEGEND ORIENTATION³

- 0 No legend
- 1 Orientation 1
- 2 Orientation 2

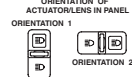

Contura X, XI & XII actuator lens assembly separately:

VVL 2 1 00 0

1 Lens Separately 2 Lens Style 3 Lens Color 4 Legend 5 Legend Orientation

1 CONTURA X, XI & XII LENS SEPARATELY
VVL

2 LENS STYLE³

- 1 Bar lens 2 One Piece Square lens 3 Bottom of Two-Piece Square lens⁵

3 TRANSLUCENT LENS COLOR

- 1 Clear 2 White 3 Amber 4 Green⁴ 5 Red 6 Blue⁴

4 LENS OR BODY LEGEND²

- 00 - No Legend
- 21 OFF 22 ON 23 O 24 I
- 25 O 26 O 27 O 28 I
- F N
- F

For additional legend options & codes, visit us at www.carlingtech.com.

5 LEGEND ORIENTATION³

- 0 No legend
- 1 Orientation 1
- 2 Orientation 2
- 3 Orientation 3
- 4 Orientation 4

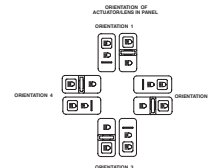

Easily integrate Contura products into your system, with Contura Accessories

Contura Connectors

| Q.C. SELECTION GUIDE | | | | | |
|-------------------------------|-------------|------------------|------------|-----------------------|-------------|
| COMPANY SERIES | PART NO | | WIRE RANGE | | ORIENTATION |
| | PLAIN BRASS | TIN PLATED BRASS | AWG | MM ² (REF) | |
| PACKARD 58 SERIES | 02965580 | | 12 | 3.0 | B |
| | 02965471 | 12010601 | (2)16-14 | (2)1.0-2.0 | |
| | 02965470 | | 16-14 | 1.0-2.0 | |
| | 02965469 | 06288318 | 20-18 | .5-.8 | |
| PACKARD METRI-PACK 630 SERIES | | 12084590 | 10 | 5.0 | A |
| | | 12052224 | 12 | 3.0 | |
| | | 12015870 | 16-14 | 1.0-2.0 | |
| | | 12020035 | (2)22-18 | (2).5-.8 | |
| | 12015832 | 12015869 | 20-18 | .5-.8 | |
| | | 12052222 | 20-22 | .35-.5 | |
| AMP 250 SERIES FASTIN-FASTON | 60253-1 | 60253-2 | 16-12 | 1.3-3 | B |
| | 42100-1 | 42100-2 | (2) 16 | (2) 1.3 | |
| | 60295-1 | 60295-2 | 22-18 | .3-.9 | |

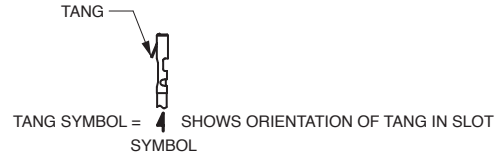
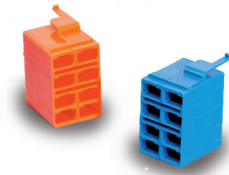

NOTE: Consult Delphi Packard and/or Amp on actual part numbers and availability. AMP is a registered trademark of AMP Inc. Harrisburg, PA. Delphi Packard is a registered trademark of Delphi-Packard Electrical Systems Warren, Ohio

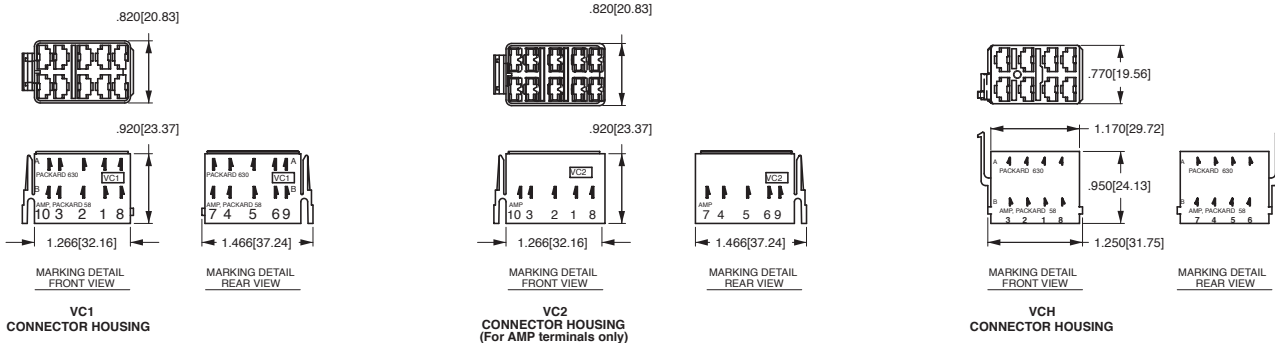

Contura X Boot (P/N VB1-01)

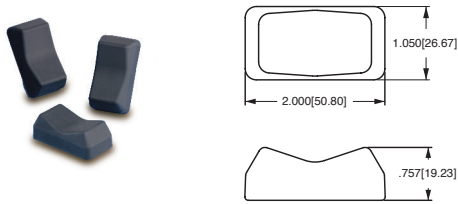

Additional V-Series Ratings

- 1 .4VA @ 28VDC Resistive
- 4 10A 250VAC 1/2 HP, 15A 125 VAC 1/2 HP, No Agency Listings
- 5 10A 250VAC 1/2 HP, 15A 125 VAC 1/2 HP, UL Recognized, CSA Certified
- 6* 15A 125VAC 1/2 HP, 12(2)A 125 VAC μ T85
- 7* 15A 125VAC 1/2 HP, 12(6)A 125 VAC T85
- 8* 10A 250VAC, 15A 125VAC, 1/2 HP 125-250VAC, 12(2)A 250 VAC μ T85
- 9* 10A 250VAC, 15A 125VAC, 1/2 HP 125-250VAC, 12(6)A 250 VAC T85
- B 15A 24V
- C 20A 18V
- D 20A 12V
- E 20A 14V, 10A 14VT (circuits 1, 4, A, & D only)
- F 10A 14V, 6A, 14VT (circuit G only)
- G 20A 6V
- H 20A 3V
- L 15A 125 VAC, 10A 250VAC, 1/2 HP 125-250 VAC; 6A 125 VAC L
- M .4VA/20A 12V (combi-contact)
- (combination gold/silver contacts for borderline dry circuit applications)
- N .4VA/15A 24V (combi-contact)
- (combination gold/silver contacts for borderline dry circuit applications)

Contura II, III, IV & V Actuator Removal Tool (P/N VRT)

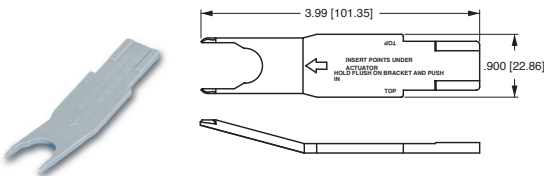

NOTES

Consult factory to determine availability for individual circuits and their HP rating.
 * Ratings 6 - 9 are UL, CSA & VDE certified, require terminations A or B for double pole circuits, & are not available with illumination circuits 4, 8, D, J, N, & T or with wire lead or solder lug terminations.
 Circuits 1, 4, A, D, H, M & E are not available with rating 6 & 8. Rating 7 & 9 only available with circuits 1, 4, A & D. Circuits 2, 3, 5, 7, 8, K, L are 1/2 HP 250VAC only with rating 8. Ratings 6 & 7 must specify lamp code 1 (125VAC neon). Ratings 8 & 9 must specify lamp code 2 (250VAC neon). Rating L available with circuits 1, 4, A & D only.

Contura Mounting Panels Dimensional Specifications: in. [mm]

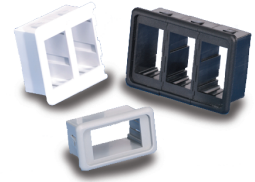

MOUNTING PANEL
For additional units, add 1.03[26.2] per unit.
For more than 2 V-Series Switches, add middle section. Available in Panel Thicknesses listed below. Consult factory.

MOUNTING PANEL THICKNESS
.062[1.57] .167[4.75]
.085[2.36] .250[6.35]
.125[3.17] .375[9.52]

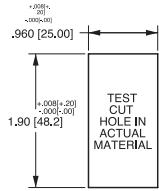

VMS MOUNTING HOLE

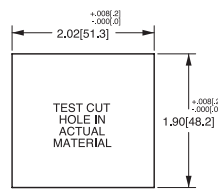

MOUNTING PANEL OPENING (2) UNITS

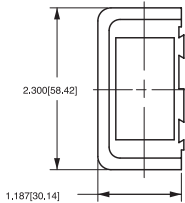

VME MOUNTING PANEL END

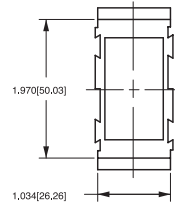

VMM MOUNTING PANEL MIDDLE

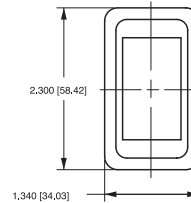

VMS MOUNTING PANEL

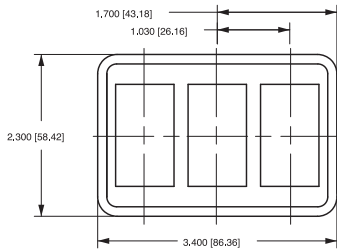

VM3 MOUNTING PANEL

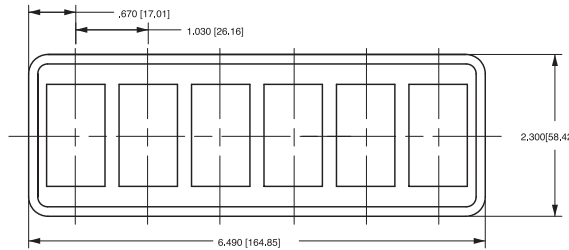

VM6 MOUNTING PANEL

Contura Hole Plug Dimensional Specifications: in. [mm]

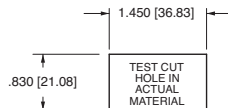

VHP CONTURA II, III HOLE PLUG

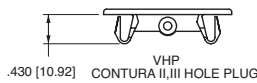

VHP CONTURA II, III HOLE PLUG

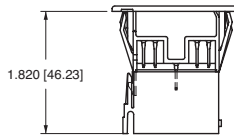

VH1 STANDARD HOLE PLUG (No wing serrations) (With VC1 connector attached)

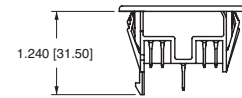

VH2 STANDARD HOLE PLUG (With wing serrations)

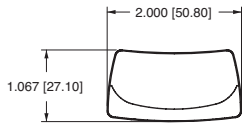

(TYP. FOR VH3 & VH4)

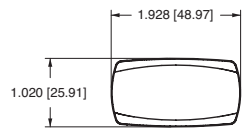

(TYP. FOR VH5 & VH6)

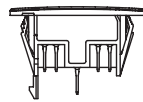

VH3 CONTURA IV HOLE PLUG (No wing serrations)

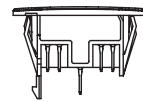

VH4 CONTURA IV HOLE PLUG (With wing serrations)

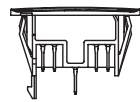

VH5 CONTURA V HOLE PLUG (No wing serrations)

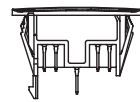

VH6 CONTURA V HOLE PLUG (With wing serrations)



DETAIL VIEW VH1, VH3 & VH5 HOLE PLUGS (No wing serrations for ease of removal)



DETAIL VIEW VH2, VH4 & VH6 HOLE PLUGS (With wing serrations)

* Intentionally left blank

* Intentionally left blank

Worldwide Headquarters

Carling Technologies, Inc.
60 Johnson Avenue • Plainville, CT 06062-1177
Phone: (860) 793-9281 • Fax: (860) 793-9231
Email: sales@carlingtech.com • www.carlingtech.com

East Region Sales Office, CT • ersm@carlingtech.com
Midwest Region Sales Office, IL • mrs@carlingtech.com
West Region Sales Office, CA • wrsm@carlingtech.com

Asia-Pacific Headquarters

Carling Technologies, Asia-Pacific Ltd.,
Kowloon, Hong Kong
Int + 852-2737-2277 • Fax: Int + 852-2736-9332
Email: sales@carlingtech.com.hk

Shenzhen, China • shenzhen@carlingtech.com
Shanghai, China • shanghai@carlingtech.com
Pune, India • india@carlingtech.com
Kaohsiung, Taiwan • taiwan@carlingtech.com
Yokohama, Japan • japan@carlingtech.com

Europe / Middle East / Africa Headquarters

Carling Technologies, Ltd.,
Devon, England
Int + 44 1392-364422 • Fax: Int + 44 1392-364477
Email: ltd.sales@carlingtech.com

GmbH, Germany • gmbh@carlingtech.com
SAS, France • sas@carlingtech.com

REV_SW_V_1112



Carling Technologies®

Innovative Designs. Powerful Solutions.

Innovative Designs. Powerful Solutions.